

**TÜV RHEINLAND  
ENERGIE UND UMWELT GMBH**



Report on the performance test of the APDA-371 ambient dust monitor with PM<sub>2.5</sub> pre-separator for suspended particulate matter PM<sub>2.5</sub> manufactured by HORIBA Europe GmbH in Oberursel,

TÜV-Report No.: 936/21221789/B  
Cologne, 19 March 2013

[www.umwelt-tuv.de](http://www.umwelt-tuv.de)



[luft@de.tuv.com](mailto:luft@de.tuv.com)

**TÜV Rheinland Energie und Umwelt GmbH and its Ambient Air Quality department in particular**  
is accredited for the following activities:

- Determination of emissions and ambient air quality affected by air pollutants and odorous substances,
- Inspection of correct installation, functionality and calibration of continuous emission monitoring systems including systems for data evaluation and remote monitoring of emissions,
- Measurements in combustion chambers;
- Performance testing of measuring systems for continuous monitoring of emissions and air quality as well as electronic data evaluation and remote monitoring systems for emissions
- Determination of the stack height and air quality forecasts for hazardous and odorous substances;
- Determination of emissions and ambient air quality affected by noise and vibration, determination of sound power levels and noise measurements at wind turbines;

**according to EN ISO/IEC 17025.**

The accreditation will expire on 22-01-2018. DAkkS registration number: D-PL-11120-02-00.

Reproduction of extracts from this test report is subject to prior written consent.

**TÜV Rheinland Energie und Umwelt GmbH**  
**D - 51105 Köln, Am Grauen Stein, phone: + 49 (0) 221 806-5200, fax: +49 (0) 221 806-1349**

Report on the performance test of the APDA-371 ambient dust monitor with PM2.5 pre-separator for suspended particulate matter PM2.5 manufactured by HORIBA Europe GmbH in Oberursel,  
Report: 936/21221789/B

**Blank page**

## Summary Overview

HORIBA Europe GmbH commissioned TÜV Rheinland Energie und Umwelt GmbH to carry out performance testing of the APDA-371 ambient dust monitor with PM<sub>2.5</sub> pre-separator for suspended particulate matter PM<sub>2.5</sub>. The performance test was carried out in respect of the following standards and requirements:

- VDI Guideline 4202, Part 1 – “Performance criteria for performance tests of automated ambient air measuring systems – Point-related measurement methods for gaseous and particulate air pollutants,” dated June 2002.
- VDI Guideline 4203, part 3 – “Testing of automated measuring systems – Test procedures for point-related ambient air measuring systems for gaseous and particulate air pollutants”, dated August 2004
- European standard EN 14907, “Ambient air quality – Standard gravimetric measurement method for the determination of PM<sub>2.5</sub> mass fraction of suspended particulate matter”, German version EN 14907: 2005
- Guideline “Demonstration of Equivalence of Ambient Air Monitoring Methods”, English version dated January 2010

The APDA-371 ambient dust monitor with PM<sub>2.5</sub> pre-separator uses a radiometric method to determine dust concentrations. A pump sucks in ambient air via the PM<sub>2.5</sub> pre-separator (consisting of a PM<sub>10</sub> sampling head and a PM<sub>2.5</sub> Sharp Cut Cyclone). The dust-loaded sample air is then pulled to a filter tape. The determination of the mass concentration precipitated on the filter tape is then performed relying on the principle of beta absorption.

The tested certification range was:

| Component         | Certification range      |
|-------------------|--------------------------|
| PM <sub>2.5</sub> | 0–1000 µg/m <sup>3</sup> |

With the exception of a modified front design, the APDA-371 ambient dust monitor with PM<sub>2.5</sub> pre-separator is absolutely identical to the BAM-1020 measuring system designed and completely manufactured by Met One Instruments, Inc. The latter is publically announce as performance-tested in the Federal Gazette as BAM-1020 with PM<sub>2.5</sub> pre-separator. The announcement history of the BAM-1020 with PM<sub>2.5</sub> pre-separator manufactured by Met One Instruments, Inc. is as follows:

Original announcement:

BAM-1020 with PM<sub>2.5</sub> pre-separator UBA announcement of 12 April 2010 (BAnz. S. 2597, Chapter II Number 1.1)

The most recent notification regarding this measuring system was:

BAM-1020 with PM<sub>2.5</sub> pre-separator, UBA announcement of 6 July 2012 (BAnz AT 20.07.2012 B11, Chapter IV 6<sup>th</sup> notification), statement issued on 21 March 2012.

A further statement dated 18 March 2013 will be submitted to the relevant body regarding the software version of the measuring system.

The first publication of the BAM-1020 measuring system with PM<sub>2.5</sub> pre-separator manufactured by Met One Instruments, Inc. already made reference, under note 7 of the announcement, to the identical APDA-371 ambient dust monitor with PM<sub>2.5</sub> pre-separator distributed by HORIBA Europe GmbH. Based on this announcement, a certificate was also issued for the APDA-371 ambient dust monitor with PM<sub>2.5</sub> pre-separator. Moreover, the following notification was published with respect to the APDA-371 ambient dust monitor with PM<sub>2.5</sub> pre-separator manufactured by HORIBA Europe GmbH:

APDA-371 ambient dust monitor with PM<sub>2.5</sub> pre-separator, UBA announcement of 6 July 2012 (BAnz AT 20.07.2012 B11, Chapter IV 2<sup>nd</sup> notification), statement issued on 22 March 2012.

The statement mentioned above also applies to the APDA-371 ambient dust monitor with PM<sub>2.5</sub> pre-separator. It was taken into account for the relevant notification proposal and listed in the appendix.

Report on the performance test of the APDA-371 ambient dust monitor with PM<sub>2.5</sub> pre-separator for suspended particulate matter PM<sub>2.5</sub> manufactured by HORIBA Europe GmbH in Oberursel,  
Report: 936/21221789/B

Page 5 of 10

No actual test were performed for the performance test of the APDA-371 ambient dust monitor with PM<sub>2.5</sub> pre-separator. The publication is based on document inspections and on-site audits.

The measuring system is exclusively manufactured by Met One Instruments, Inc. in Grants Pass, USA. The instruments are manufactured at the same time as the manufacturer's own instruments under the exact same conditions by the same staff using the same material. Checks of the relevant drawings and audits of the production site in Grants Pass demonstrated that the instruments are absolutely identical in design.

The minimum requirements were satisfied during the performance test.

TÜV Rheinland Energie und Umwelt GmbH therefore propose public announcement of the tested measuring system as certified for continuous monitoring of the ambient air quality affected by suspended particulate matter, PM<sub>2.5</sub> fraction.

The present report contains a certification proposal for the APDA-371 ambient dust monitor with PM<sub>2.5</sub> pre-separator. Appendices include the report on performance testing of the BAM-1020 measuring system with PM<sub>2.5</sub> pre-separator, notifications regarding the APDA-371 ambient dust monitor with PM<sub>2.5</sub> pre-separator and the manual for the APDA-371 ambient dust monitor with PM<sub>2.5</sub> pre-separator.

Report on the performance test of the APDA-371 ambient dust monitor with PM2.5 pre-separator for suspended particulate matter PM2.5 manufactured by HORIBA Europe GmbH in Oberursel,  
Report: 936/21221789/B

**Blank page**

Report on the performance test of the APDA-371 ambient dust monitor with PM2.5 pre-separator for suspended particulate matter PM2.5 manufactured by HORIBA Europe GmbH in Oberursel,  
Report: 936/21221789/B

Page 7 of 10



Report on the performance test of the APDA-371 ambient dust monitor with PM2.5 pre-separator for suspended particulate matter PM2.5 manufactured by HORIBA Europe GmbH in Oberursel

**AMS designation:** APDA-371 ambient dust monitor with PM<sub>2.5</sub> pre-separator for suspended particulate matter PM<sub>2.5</sub>

**Manufacturer:** HORIBA Europe GmbH  
Hans-Mess-Straße 6  
61440 Oberursel

**Test period:** July 2008 to March 2010

**Date of report:** 19 March 2013

**Report Number:** 936/21221789/B

**Editor:** Dipl.-Ing. Karsten Pletscher  
[karsten.pletscher@de.tuv.com](mailto:karsten.pletscher@de.tuv.com)

**Technical Supervisor:** Dr Peter Wilbring  
[peter.wilbring.@de.tuv.com](mailto:peter.wilbring.@de.tuv.com)

Report on the performance test of the APDA-371 ambient dust monitor with PM2.5 pre-separator for suspended particulate matter PM2.5 manufactured by HORIBA Europe GmbH in Oberursel,  
Report: 936/21221789/B

**Blank page**



Report on the performance test of the APDA-371 ambient dust monitor with PM<sub>2.5</sub> pre-separator for suspended particulate matter PM<sub>2.5</sub> manufactured by HORIBA Europe GmbH in Oberursel, Report: 936/21221789/B

## 1. General

### 1.1 Certification proposal

Based on the positive results obtained, the following recommendation on the announcement of the AMS as a certified system is put forward:

**AMS designation:**

APDA-371 with PM<sub>2.5</sub> pre-separator

**Manufacturer:**

HORIBA Europe GmbH, Oberursel

**Field of application:**

For continuous monitoring of suspended particulate matter, PM<sub>2.5</sub> fraction, in ambient air from stationary sources

**Measurement ranges during performance testing:**

| Component         | Certification range | Unit              |
|-------------------|---------------------|-------------------|
| PM <sub>2.5</sub> | 0–1000              | µg/m <sup>3</sup> |

**Software versions:**

Version 3236-07 5.1.1

**Restrictions:**

None

**Notes:**

1. The measuring system complies with the requirements of guideline “Demonstration of Equivalence of Ambient Air Monitoring Methods”, version dated January 2010 for the component PM<sub>2.5</sub>.
2. For monitoring PM<sub>2.5</sub> the instrument must at least be equipped with the following: Sample heater (BX-830), PM<sub>2.5</sub> sampling head (BX-802), PM<sub>2.5</sub> Sharp Cut Cyclone SCC (BX-807), combined pressure and temperature sensor (BX-596) or alternatively ambient temperature sensor (BX-592)
3. Cycle time during performance testing was 1s. Thus filters were automatically replaced once an hour. Every filter spot was sampled once only.
4. Sampling time in the cycle time is 42s.
5. The measuring system must be operated in a lockable measurement cabinet.
6. The instrument must be calibrated on-site regularly using a gravimetric PM<sub>2.5</sub> reference method in accordance with EN 14907.
7. Optionally, the measuring system may be operated with the BX-125 pump.
8. Since January 2012, the measuring system has been sold with a re-designed back plate, which provides space for additional interfaces such as the BX-965 report processor for example.
9. The instrument was first certified on the basis of UBA announcement of 12 July 2010 (BAnz. S. 2597, Chapter II Number 1.1 note 7) The most recent notification was that announced by the Federal Environment Agency on 6 July 2012 (BAnz

AT 20.07.2012 B11, chapter IV, 2<sup>nd</sup> notification).

10. This report on the performance test is available online at [www.qal1.de](http://www.qal1.de).

**Test Report:**

TÜV Rheinland Energie und Umwelt GmbH, Cologne  
Report no.: 936/21221789/B dated 19 March 2013

Cologne, 19 March 2013



Dipl.-Ing. Karsten Pletscher

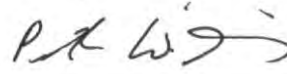

Dr. Peter Wilbring

**Appendices**

- Report on the performance test of the BAM-1020 measuring system with PM<sub>2.5</sub> pre-separator for suspended particulate matter PM<sub>2.5</sub> manufactured by Met One Instruments, Inc., TÜV Report No. 936/21209919/A of 26 March 2010
- Notifications published with respect to the APDA-371 with PM<sub>2.5</sub> pre-separator manufactured by HORIBA Europe GmbH
- Operation manual for the APDA-371 ambient dust monitor with PM<sub>2.5</sub> pre-separator.

## TÜV RHEINLAND ENERGY GMBH



Addendum to Report No. 936/21221789/B of 19 March 2013 on the performance test of the APDA-371 ambient air quality monitor for suspended particulate matter, PM<sub>2,5</sub> manufactured by Horiba Europe GmbH

TÜV Report No.: 936/21246946/B  
Cologne, 7 September 2019

[www.umwelt-tuv.de](http://www.umwelt-tuv.de)



[tre-service@de.tuv.com](mailto:tre-service@de.tuv.com)

**TÜV Rheinland Energy GmbH and its Ambient Air Quality department in particular**  
is accredited for the following activities:

- Determination of emissions and ambient air quality affected by air pollutants and odorous substances,
- Inspection of correct installation, function and calibration of continuously operating emission measuring instruments, including data evaluation and remote emission monitoring systems;
- Measurements in combustion chambers;
- Performance testing of measuring systems for continuous monitoring of emissions and ambient air, and of electronic data evaluation and remote emission monitoring systems;
- Determination of the stack height and air quality forecasts for hazardous and odorous substances;
- Determination of emissions and ambient air quality affected by noise and vibration, determination of sound power levels and noise measurements at wind turbines;

**according to EN ISO/IEC 17025.**

The accreditation will expire on 10-12-2022 and covers the scope specified in the annex to certificate D-PL-11120-02-00.

Reproduction of extracts from this test report is subject to prior written consent.

**TÜV Rheinland Energy GmbH**  
**D - 51105 Köln, Am Grauen Stein,**  
**Tel: + 49 (0) 221 806-5200, fax: +49 (0) 221 806-1349**

**Blank page**

## Summary Overview

HORIBA Europe GmbH commissioned TÜV Rheinland Energy GmbH to carry out a performance test of the APDA-371 ambient air quality measuring system for suspended particulate matter, PM<sub>2.5</sub> in accordance with the following standards and requirements:

- VDI Guideline 4202, Part 1 – “Performance criteria for performance tests of automated ambient air measuring systems – Point-related measurement methods for gaseous and particulate air pollutants,” dated September 2010 or June 2002 respectively.
- VDI Guideline 4203, part 3 – “Testing of automated measuring systems – Test procedures for point-related ambient air measuring systems for gaseous and particulate air pollutants”, dated September 2010 or August 2004 respectively.
- European standard EN 14907, “Ambient air quality – Standard gravimetric measurement method for the determination of PM<sub>2.5</sub> mass fraction of suspended particulate matter”, German version EN 14907:2005 (withdrawn)
- European standard EN 12341, “Ambient air - Standard gravimetric measurement method for the determination of the PM<sub>10</sub> or PM<sub>2.5</sub> mass concentration of suspended particulate matter”; German version EN 12341:2014
- Guideline “Demonstration of Equivalence of Ambient Air Monitoring Methods”, English version of January 2010

Regarding standards EN EN 14907 and EN 12341, it should be noted that standard EN 14907:2005 was applicable at the time of the original performance test. This is why the standard is cited here for the sake of completeness. Its successor, standard EN 12341:2014 was added to the list.

The APDA-371 measuring system uses a radiometric principle to determine dust concentrations. A pump sucks in ambient air through a PM<sub>2.5</sub> sample inlet. The dust loaded sample air is then sucked onto a filter tape. After having been sampled, the dust mass separated on the filter tape is determined by way of a radiometric method, namely beta ray absorption.

The tested certification range was:

| Component         | Certification range        |
|-------------------|----------------------------|
| PM <sub>2.5</sub> | 0–10,000 µg/m <sup>3</sup> |

Except for a re-designed front plate, the APDA-371 measuring system is identical to the BAM-1020 measuring systems. They have been developed by Met One Instruments Inc. who are also completely responsible for AMS manufacturing of this system. The manufacturer produces the systems simultaneously under the exact same conditions as the BAM-1020 including personnel and materials employed. Inspections of the relevant drawings and audits of the production site in Grants Pass demonstrated that the instrument versions are completely identical.

Given the identical design, the APDA-371 measuring system had not been physically tested before their initial publication as performance tested. All tests were performed with the BAM-1020 measuring system by the original equipment manufacturer Met One. Only a document inspection was carried out and the production site is audited regularly.

The publication history for the APDA-371 measuring system for suspended particulate matter, PM<sub>2.5</sub>, distributed by HORIBA Europe GmbH is provided below.

- APDA-371 for suspended particulate matter PM<sub>2.5</sub>, Federal Environment Agency notice of 3 July 2013 (BAnz AT 23.07.2013 B4, chapter III number 2.1) – initial announcement of suitability.
- APDA-371 for suspended particulate matter PM<sub>2.5</sub>, Federal Environment Agency notice of 22 July 2015 (BAnz AT 26.08.2015 B4, chapter V notification 43) – notification of new vacuum pump
- APDA-371 for suspended particulate matter PM<sub>2.5</sub>, Federal Environment Agency notice of 13 July 2017 (BAnz AT 31.07.2017 B12, chapter II notification 32) – notification of new software version (3236-7 V 5.5.0)

Standard EN 16450 “Ambient air — Automated measuring systems for the measurement of the concentration of particulate matter (PM<sub>10</sub>; PM<sub>2.5</sub>) has been available since July 2017. This standard, for the first time, harmonises requirements for the performance testing of automated measuring systems for the determination of dust concentrations (PM<sub>10</sub> and PM<sub>2.5</sub>) on a European level and will form the basis for the approval of such AMS in the future.

The present addendum contains an assessment of the APDA-371 measuring system with regard to compliance with the requirements of standard EN 16450 (July 2017). Given the identical design of the APDA-371 and BAM-1020, the APDA-371 measuring system did not undergo physical testing with regard to compliance with the requirements of standard EN 16450. All relevant results (re-assessment and re-testing) are taken from the tests performed with the BAM-1020 measuring system provided by Met One, the original equipment manufacturer. Tests and their results were presented in “Addendum to the report on the performance test of the BAM-1020 measuring system for suspended particulate matter, PM<sub>2.5</sub>, with PM<sub>2.5</sub> pre-separator manufactured by Met One Instruments Inc., Report No. 936/21243375/A dated 21 September 2018. Alongside the test report, this basic addendum aimed at the initial approval (TÜV Report no. 936/21221789/B dated 19 March 2013) served as appendix to this report.

It was demonstrated that the APDA-371 measuring system meets the requirements of standard EN 16450:2017.

On its publication, this addendum becomes an integral part of TÜV Rheinland test report no. 936/21221789/B dated 13 March 2013 and will be available at [www.qal1.de](http://www.qal1.de).

Environmental Protection/Air Pollution Control

Cologne, 7 September 2019



Dipl.-Ing. Fritz Hausberg  
936/21246946/B

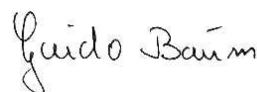

Dipl.-Ing. Guido Baum



Addendum to Report No. 936/21221789/B of 19 March 2013 on the performance test of the APDA-371 ambient air quality monitor for suspended particulate matter, PM<sub>2,5</sub> Report No. 936/21246946/B

Page 5 of 10

## 2 Schwebstaub (PM<sub>2,5</sub>-Fraktion)

### 2.1 APDA-371 mit PM<sub>2,5</sub>-Vorabscheider

Hersteller:

HORIBA Europe GmbH, Oberursel

Eignung:

Zur kontinuierlichen Immissionsmessung der PM<sub>2,5</sub>-Fraktion im Schwebstaub im stationären Einsatz

Messbereich in der Eignungsprüfung:

| Komponente        | Zertifizierungsbereich | Einheit           |
|-------------------|------------------------|-------------------|
| PM <sub>2,5</sub> | 0 – 1 000              | µg/m <sup>3</sup> |

Softwareversion: Version 3236-07 5.1.1

Einschränkungen:

Keine

Hinweise:

1. Die Anforderungen gemäß des Leitfadens „Demonstration of Equivalence of Ambient Air Monitoring Methods“ in der Version vom Januar 2010 werden für die Messkomponente PM<sub>2,5</sub> eingehalten.
2. Das Gerät ist zur Erfassung von PM<sub>2,5</sub> mit folgenden Optionen auszustatten: Probenahmeheizung (BX-830), PM<sub>10</sub>-Probenahmekopf (BX-802), PM<sub>2,5</sub> Sharp Cut Cyclone SCC (BX-807), kombinierter Druck- und Temperatursensor (BX-596) bzw. alternativ Umgebungstemperatursensor (BX-592).
3. Die Zykluszeit während der Eignungsprüfung betrug 1 h, d. h. jede Stunde wurde ein automatischer Filterwechsel durchgeführt. Jeder Filterleck wurde nur einmal beprobt.
4. Die Probenahmezeit innerhalb der Zykluszeit beträgt 42 min.
5. Die Messeinrichtung ist in einem verschließbaren Messcontainer zu betreiben.
6. Die Messeinrichtung ist mit dem gravimetrischen PM<sub>2,5</sub>-Referenzverfahren nach DIN EN 14907 regelmäßig am Standort zu kalibrieren.
7. Die Messeinrichtung kann optional mit der Pumpe BX-125 betrieben werden.
8. Die Messeinrichtung wird seit Januar 2012 mit einer neu designten Rückplatte vertrieben, um die erweiterten Schnittstellen, u. a. des optionalen Reportprozessors BX-965, unterzubringen.
9. Die Erstbekanntgabe der Messeinrichtung erfolgte mit Bekanntmachung des Umweltbundesamtes vom 12. Juli 2010 (BAnz. S. 2597, Kapitel II Nummer 1.1 Hinweis 7). Die letzte Mitteilung zur Messeinrichtung erfolgte mit Bekanntmachung des Umweltbundesamtes vom 6. Juli 2012 (BAnz AT 20.07.2012 B11, Kapitel IV 2. Mitteilung).
10. Der Prüfbericht über die Eignungsprüfung ist im Internet unter [www.qal1.de](http://www.qal1.de) einsehbar.

Prüfinstitut: TÜV Rheinland Energie und Umwelt GmbH, Köln

Bericht-Nr.: 936/21221789/B vom 19. März 2013

Figure 1: Initial publication: BAnz AT 23.07.2013 chapter III number 2.1

### 43 Mitteilung zu den Bekanntmachungen des Umweltbundesamtes vom 3. Juli 2013 (BAnz AT 23.07.2013 B4, Kapitel III Nummer 2.1) und vom 25. Februar 2015 (BAnz AT 02.04.2015 B5, Kapitel IV 10. Mitteilung)

Die Immissionsmesseinrichtung APDA-371 mit PM<sub>2,5</sub>-Vorabscheider der Firma HORIBA Europe GmbH kann auch mit der Vakuumpumpe vom Typ BECKER VT 4.4 betrieben werden.

Stellungnahme der TÜV Rheinland Energie und Umwelt GmbH vom 23. März 2015.

Figure 2: Public notice BAnz AT 26.08.2015 B4, chapter V notification 43

### 32 Mitteilung zu den Bekanntmachungen des Umweltbundesamtes vom 3. Juli 2013 (BAnz AT 23.07.2013 B4, Kapitel III Nummer 2.1) und vom 22. Juli 2015 (BAnz AT 26.08.2015 B4, Kapitel V 43. Mitteilung)

Die aktuelle Softwareversion für die Immissionsmesseinrichtung APDA-371 mit PM<sub>2,5</sub>-Vorabscheider für Schwebstaub PM<sub>2,5</sub> der Firma HORIBA Europe GmbH lautet:

3236-7 V 5.5.0.

Stellungnahme der TÜV Rheinland Energy GmbH vom 8. März 2017

Figure 3: Public notice BAnz AT 31.07.2017 B12, chapter II notification 32

**Appendices:**

- Report on the performance test of the APDA-371 ambient air monitor for suspended particulate matter PM<sub>2,5</sub> manufactured by HORIBA Europe GmbH, TÜV Report no. 936/21221789/B dated 19 March 2013
- Addendum to test report no. 936/21209919/A dated 26 March 2010 on the performance test of the BAM-1020 measuring system for suspended particulate matter, PM<sub>2,5</sub> manufactured by Met One Instruments Inc., Report No.: 936/21243375 dated 21 September 2018



Addendum to Report No. 936/21221789/B of 19 March 2013 on the performance test of the APDA-371 ambient air quality monitor for suspended particulate matter, PM<sub>2,5</sub> Report No. 936/21246946/B

Page 7 of 10

## Appendix

## TÜV RHEINLAND IMMISSIONSSCHUTZ UND ENERGIESYSTEME GMBH

Akkreditiertes Prüfinstitut



Report on the suitability test of the ambient air quality measurement system BAM-1020 with PM<sub>2.5</sub> pre-separator of the company Met One Instruments, Inc. for the component suspended particulate matter PM<sub>2.5</sub>

**TÜV Report No.: 936/21209919/A**  
Koeln, March 26, 2010

[www.umwelt-tuv.de](http://www.umwelt-tuv.de)



[luft@de.tuv.com](mailto:luft@de.tuv.com)

### **TÜV Rheinland Immissionsschutz und Energiesysteme GmbH**

are accredited for the following work areas:

- Determination of emissions and immissions of air pollution and odor substances;
- Inspection of correct installation, function and calibration of continuously running emission measuring devices including systems for data evaluation and remote monitoring of emissions;
- Suitability testing of measuring systems for continuous monitoring of emissions and immissions, and of electronic systems for data evaluation and remote monitoring of emissions

**according to EN ISO/IEC 17025.**

The accreditation is valid up to 31-01-2013. DAR-register number: DAP-PL-3856.99.

**Reproduction of extracts from this test report is subject to written consent.**

**TÜV Rheinland Immissionsschutz und Energiesysteme GmbH**  
**D - 51105 Koeln, Am Grauen Stein, Tel: 0221 806-2756, Fax: 0221 806-1349**



Report on the suitability test of the ambient air quality measurement system BAM-1020 with PM2.5 pre-separator of the company Met One Instruments, Inc. for the component suspended particulate matter PM2.5,  
Report No.: 936/21209919/A

Page 3 of 285



Report on the suitability test of the ambient air quality measurement system BAM-1020 with PM2.5 pre-separator of the company Met One Instruments, Inc. for the component suspended particulate matter PM2.5

**Device tested:** BAM-1020 with PM2.5 pre-separator

**Manufacturer:** Met One Instruments, Inc.  
1600 NW Washington Blvd.  
Grants Pass, Oregon 97526  
USA

**Test period:** Start: July 2008  
End: March 2010

**Date of report:** March 26, 2010

**Report number:** 936/21209919/A

**Editor:** Dipl.-Ing. Karsten Pletscher  
T.: +49 221 806-2592  
[karsten.pletscher@de.tuv.com](mailto:karsten.pletscher@de.tuv.com)

**Scope of report:**

|        |          |       |
|--------|----------|-------|
| Report | 146      | Pages |
| Annex  | Page 147 | ff.   |
| Manual | Page 189 | ff.   |
| Manual | of 96    | Pages |
| Total  | 285      | Pages |



## **Content**

|     |  |    |
|-----|--|----|
| 1   | SUMMARY AND PROPOSAL FOR DECLARATION OF SUITABILITY..... | 9  |
| 1.1 | Summary.....   | 9  |
| 1.2 | Notification proposal:.....                              | 13 |
| 1.3 | Summary of test results.....                             | 15 |
| 2   | TASK DEFINITION .....                                    | 21 |
| 2.1 | Type of test.....  | 21 |
| 2.2 | Objective .....  | 21 |
| 3   | DESCRIPTION OF THE TESTED MEASURING SYSTEM.....          | 22 |
| 3.1 | Measuring principle .....                                | 22 |
| 3.2 | Functionality of the measuring system .....              | 23 |
| 3.3 | AMS scope and layout .....                               | 25 |
| 4   | TEST PROGRAM .....                                       | 40 |
| 4.1 | General.....   | 40 |
| 4.2 | Laboratory test .....                                    | 40 |
| 4.3 | Field test.....  | 41 |
| 5   | REFERENCE MEASUREMENT PROCEDURES.....                    | 52 |
| 6   | TEST RESULTS .....                                       | 53 |
| 6.1 | 4.1.1 Display for measured values .....                  | 53 |
| 6.1 | 4.1.2 Easy maintenance .....                             | 54 |
| 6.1 | 4.1.3 Function test.....                                 | 56 |
| 6.1 | 4.1.4 Setup- and warm-up times .....                     | 58 |
| 6.1 | 4.1.5 Instrument design .....                            | 60 |
| 6.1 | 4.1.6 Security.....                                      | 61 |
| 6.1 | 4.1.7 Data output.....                                   | 62 |

|     |  |     |
|-----|--|-----|
| 6.1 | 4.2 Requirements for mobile measuring systems .....              | 64  |
| 6.1 | 5.1 General.....   | 65  |
| 6.1 | 5.2.1 Measuring range.....                                       | 66  |
| 6.1 | 5.2.2 Negative output signals .....                              | 67  |
| 6.1 | 5.2.3 Analytical function.....                                   | 68  |
| 6.1 | 5.2.4 Linearity .....  | 70  |
| 6.1 | 5.2.5 Detection limit .....                                      | 71  |
| 6.1 | 5.2.6 Response time.....   | 73  |
| 6.1 | 5.2.7 Ambient temperature dependency of zero point.....          | 74  |
| 6.1 | 5.2.8 Ambient temperature dependency of the measured value ..... | 76  |
| 6.1 | 5.2.9 Zero drift .....   | 78  |
| 6.1 | 5.2.10 Drift of the measured value .....                         | 83  |
| 6.1 | 5.2.11 Cross sensitivity.....                                    | 87  |
| 6.1 | 5.2.12 Reproducibility $R_D$ .....                               | 88  |
| 6.1 | 5.2.13 Hourly mean values.....                                   | 90  |
| 6.1 | 5.2.14 Mains voltage and frequency.....                          | 92  |
| 6.1 | 5.2.15 Power outage .....  | 94  |
| 6.1 | 5.2.16 Operating states .....                                    | 95  |
| 6.1 | 5.2.17 Switchover .....  | 96  |
| 6.1 | 5.2.18 Availability.....   | 97  |
| 6.1 | 5.2.19 Converter efficiency.....                                 | 99  |
| 6.1 | 5.2.20 Maintenance interval .....                                | 100 |
| 6.1 | 5.2.21 Total uncertainty .....                                   | 101 |
| 6.1 | 5.3.1 Equivalency of the sampling system .....                   | 104 |
| 6.1 | 5.3.2 Reproducibility of the sampling system .....               | 105 |
| 6.1 | 5.3.3 Calibration .....  | 106 |

|     |   |     |
|-----|---|-----|
| 6.1 | 5.3.4 Cross sensitivity.....  | 107 |
| 6.1 | 5.3.5 Daily averages.....   | 110 |
| 6.1 | 5.3.6 Constancy of sample volumetric flow .....   | 111 |
| 6.1 | 5.3.7 Tightness of the sampling system .....  | 115 |
| 6.1 | 5.4 Requirements for multiple-component measuring systems.....  | 117 |
| 7   | ADDITIONAL TEST CRITERIA ACCORDING TO GUIDE „DEMONSTRATION<br>OF EQUIVALENCE OF AMBIENT AIR MONITORING METHODS“ ..... | 118 |
| 7.1 | Equivalence Methodology .....   | 118 |
| 7.1 | Determination of the in-between-instrument uncertainty $u_{bs}$ [9.5.2.1] .....                                       | 119 |
| 7.1 | Calculation of the expanded uncertainty of the instruments [9.5.2.2-9.5.6].....                                       | 126 |
| 7.1 | Application of correction factors or terms [9.7] .....  | 139 |
| 8   | RECOMMENDATIONS FOR PRACTICAL USE.....  | 144 |
| 9   | LITERATURE.....   | 146 |
| 10  | APPENDIX.....   | 147 |





## 1 Summary and proposal for declaration of suitability

### 1.1 Summary

According to Directive 2008/50/EG of 21 May 2008 on “Air quality and cleaner air for Europe” (replaces Council Directive of 27 September 1996 on ambient air quality assessment and management including its daughter directives 1999/30/EC, 2000/69/EC, 2002/3/EC and the Council Decision 97/101/EC), the methods described in Standard EN12341 „Air quality - Determination of the PM<sub>10</sub> fraction of suspended particulate matter. Reference method and field test procedure to demonstrate reference equivalence of measurement methods“ and Standard EN14907 „Ambient air quality - Standard gravimetric measurement method for the determination of the PM<sub>2.5</sub> mass fraction of suspended particulate matter“ serve as reference methods for suspended particle measurement of the respective mass fraction. Anyhow, EC member states are free to use any other method in the case of particulate matter for which the Member State concerned can demonstrate displays a consistent relationship to the reference method. In that event the results achieved by that method must be corrected to produce results equivalent to those that would have been achieved by using the reference method.“ (2008/50/EC, Annex VI, B1).

The Guide “Demonstration of Equivalence of Ambient Air Monitoring Methods” [4] which was worked out by an ad hoc EC task group

(Source: <http://ec.europa.eu/environment/air/quality/legislation/pdf/equivalence.pdf>,  
Version July 2009)

describes an equivalence check method for non-standard measurement methods. Although this is not a normative Guide, it is tentatively recommended for application by so-called CAFE - committee.

The following limits were applied during suitability testing:

|                          |                      |
|--------------------------|----------------------|
|                          | PM <sub>2.5</sub>    |
| Annual limit value (1 a) | 25 µg/m <sup>3</sup> |

as well as for the calculations according to the Guide [4]

|             |                      |
|-------------|----------------------|
|             | PM <sub>2.5</sub>    |
| Limit value | 30 µg/m <sup>3</sup> |

Standard VDI 4202, sheet 1 of June 2002 describes all „Minimum requirements for suitability tests of automatic ambient air measuring systems“. General parameters for the related tests are given in Standard VDI 4203, sheet 1 „Testing of automatic measuring systems - General concepts“ of October 2001 and furthermore specified in VDI 4203, sheet 3 „Testing of automatic measuring systems - Test procedures for point-related ambient air quality measuring systems of gaseous and particulate pollutants“ of August 2004.

Since all reference values given in these standards are adapted for PM<sub>10</sub> we recommend applying the following reference values for PM<sub>2.5</sub> measurement:

|                | PM <sub>2.5</sub>     |
|----------------|-----------------------|
| B <sub>0</sub> | 2 µg/m <sup>3</sup>   |
| B <sub>1</sub> | 25 µg/m <sup>3</sup>  |
| B <sub>2</sub> | 200 µg/m <sup>3</sup> |

Only for B<sub>1</sub> an adaption has been done on the level of the limit value for the annual mean.

Report on the suitability test of the ambient air quality measurement system BAM-1020 with PM<sub>2.5</sub> pre-separator of the company Met One Instruments, Inc. for the component suspended particulate matter PM<sub>2.5</sub>,  
Report No.: 936/21209919/A

Page 11 of 285

Met One Instruments, Inc. has commissioned TÜV Rheinland Immissionsschutz und Energiesysteme GmbH with the performance of a suitability testing of BAM-1020 measuring system for the components suspended particulate matter PM<sub>2.5</sub>.

The measuring system BAM-1020 with PM<sub>10</sub> pre-separator is already suitability-tested and published in the German Bundesanzeiger.

Declaration of suitability:     BAnz.: 12.04.2007 No. 75, page 4139, based on  
  TÜV-report no. 936/21205333/A of 06.12.2006

The suitability testing of the measuring system was carried out applying the following standards and requirements:

- Standard VDI 4202 sheet 1, „Minimum requirements for suitability tests of automatic ambient air measuring systems – Point-related measurement methods of gaseous and particulate pollutants“, June 2002
- Standard VDI 4203 sheet 3, „Testing of automatic measuring systems - Test procedures for point-related ambient air quality measuring systems of gaseous and particulate pollutants“, August 2004
- Standard EN 14907, „Ambient air quality - Standard gravimetric measurement method for the determination of the PM<sub>2.5</sub> mass fraction of suspended particulate matter“, German version EN 14907: 2005
- Guide “Demonstration of Equivalence of Ambient Air Monitoring Methods”, English version of July 2009

The measuring system BAM-1020 determines the particulate concentration by a radiometer measuring principle. With the aid of a pump, ambient air is sucked *via* a PM<sub>2.5</sub> pre-separator (consisting of a PM<sub>10</sub> sampling inlet and a PM<sub>2.5</sub> Sharp Cut Cyclone). The dust-laden air is then sucked on a filter tape. The determination of the separated mass of dust on the filter tape is performed after the respective sampling by the radiometric measuring principle of beta-attenuation.

The tests took place in the laboratory and for several months in the field. The following sites were chosen for the field test:

*Table 1: Description of the test sites*

|   | Teddington (UK),<br>Summer | Cologne,<br>parking lot,<br>Winter | Bornheim,<br>Motorway, parking<br>lot,<br>Summer | Teddington (UK),<br>Winter |
|---|----------------------------|------------------------------------|--|----------------------------|
| Time period                             | 07/2008 – 11/2008          | 12/2008 – 04/2009                  | 08/2009 – 10/2009                                | 12/2009 – 02/2010          |
| No. of paired values:<br>Candidates     | 83                         | 77                                 | 60   | 46                         |
| Characteristics                         | Urban background           | Urban background                   | Rural + Motorway                                 | Urban background           |
| Classification of am-<br>bient air load | low to average             | average to high                    | low to average                                   | average                    |

The complete test was performed within the scope of the test program „Combined MCERTS and TÜV PM Equivalence Testing Programme“. In the context of European harmonization, the test program was developed by British and German test institutes (Bureau Veritas UK & Ireland, National Physical Laboratory NPL and TÜV Rheinland) and comprises the testing of the latest series of suspended particle measurement systems by different manufacturers in the laboratory and at field test sites in the UK and in Germany.

The minimum requirements were fulfilled during suitability testing.

TÜV Rheinland Immissionsschutz und Energiesysteme GmbH therefore suggests publication of BAM-1020 as a suitability-tested measuring system for continuous monitoring of suspended particulate matter PM<sub>2.5</sub> in ambient air.

Report on the suitability test of the ambient air quality measurement system BAM-1020 with PM2.5 pre-separator of the company Met One Instruments, Inc. for the component suspended particulate matter PM2.5, Report No.: 936/21209919/A

## 1.2 Notification proposal:

On the basis of the positive results that have been achieved, the following recommendation is made for the notification as a suitability-tested measuring system:

### Measuring system:

BAM-1020 with PM2.5 pre-separator for suspended particulate matter PM2.5

### Manufacturer:

Met One Instruments, Inc., Grants Pass, USA

### Suitability:

For permanent monitoring of suspended particulate matter PM<sub>2.5</sub> in ambient air (stationary operation).

### Measuring ranges during the suitability test:

| Component         | Certification range | Supplementary range | Unit              |
|-------------------|---------------------|---------------------|-------------------|
| PM <sub>2.5</sub> | <b>0 – 1,000</b>    | -                   | µg/m <sup>3</sup> |

### Software version:

Version 3236-07 5.0.10

### Restrictions:

During the check of the tightness of the sampling system within the scope of the suitability test, values of 1.8 % and 2.4 % have been determined. According to the minimum requirement, the leak rate shall not be greater than 1 % of the sample flow rate.

### Notices:

1. The requirements according to guide "Demonstration of Equivalence of Ambient Air Monitoring Methods" are fulfilled for the measured component PM<sub>2.5</sub>.
2. For the recordation of PM<sub>2.5</sub>, the system has to be equipped with the following options: Sample heater (BX-830), PM<sub>10</sub>-sampling inlet (BX-802), PM<sub>2.5</sub> Sharp Cut Cyclone SCC (BX-807), combined pressure and temperature sensor (BX-596) respectively as an alternative ambient temperature sensor (BX-592).
3. The cycle time during the suitability test was 1 h, i.e. an automatic filter change has been performed every hour. Each filter spot has been used one time.
4. The sampling time within the cycle time is 42 min.
5. The measuring system has to be operated in a lockable measuring cabinet.
6. The measuring system is to be calibrated on site in regular intervals by application of the gravimetric PM<sub>2.5</sub> reference method according to EN 14907.
7. The identical measuring system is also distributed by the company Horiba Europe GmbH, 61440 Oberursel, Germany under the name APDA-371 with PM<sub>2.5</sub> pre-separator.

**Test report:**

TÜV Rheinland Immissionsschutz und Energiesysteme GmbH, Cologne, Germany

Report-No.: 936/21209919/A of March 26, 2010

### 1.3 Summary of test results

| Minimum requirement | Specification                             | Test result  | Fulfilled  | Page   |
|---------------------|---|--|--|--------|
| 4                   | Requirements on instrument design         |  |  |        |
| 4.1                 | General requirements                      |  |  |        |
| 4.1.1               | Display for measured values               | Shall be available.  | The measuring device comprises a display for measured values.  | yes 53 |
| 4.1.2               | Easy maintenance                          | Maintenance works should be feasible from outside without taking much time and effort.   | Maintenance works can be carried out with customary tools taking reasonable time and effort.   | yes 54 |
| 4.1.3               | Function test                             | Particular instruments for function tests shall be considered as part of the device and thus shall be evaluated in the corresponding sub-tests.<br><br>Test gas units shall indicate readiness by status signals and shall allow direct or remote access to control functions via the measuring system.<br><br>The measurement uncertainty of the test gas unit shall not exceed 1% of B <sub>2</sub> within three months. | All system functions listed in the manual are available, activatable and functioning. The current system status is continuously monitored and displayed by a set of different status messages (operation, warning and error messages). | yes 57 |
| 4.1.4               | Setup- and warm-up times                  | Shall be specified in the manual.  | The setup- and warm-up times were determined.  | yes 59 |
| 4.1.5               | Instrument design                         | Shall be specified in the manual.  | The instrument design specifications listed in the operating manual are complete and correct.  | yes 60 |
| 4.1.6               | Security                                  | Shall contain a protection mechanism against unauthorized adjustment.  | The AMS is protected against unauthorized and unintended adjustment. In addition, the AMS shall be locked in a measuring cabinet.  | yes 61 |
| 4.1.7               | Data output                               | Analogue and / or digital outputs shall be available.  | Measured signals are offered analogue (0-1 resp. 10 V resp. 0-16 mA / 4-20 mA) and digital (via RS 232).   | yes 62 |
| 4.2                 | Requirements for mobile measuring systems | Permanent availability shall be ensured. The requirements of stationary operation shall also be fulfilled during mobile operation.   | In the context of the field test, the measuring system was operated at several different sites, but cannot be operated in moving vehicles.   | no 64  |



| Minimum requirement                                | Specification   | Test result  | Fulfilled | Page |
|--|---|--|-----------|------|
| 5. Performance requirements                        |   |  |           |      |
| 5.1 General  | The manufacturer's specifications given in the manual shall not contradict the results of the suitability test.   | Differences between the instrument design and the descriptions given in the manual could not be detected.  | yes       | 65   |
| 5.2 General requirements                           |   |  |           |      |
| 5.2.1 Measuring range                              | The upper limit of the measuring range shall exceed $B_2$ .   | A measuring range of 0 to 1,000 $\mu\text{g}/\text{m}^3$ is set by default. Other measuring ranges in the range between at minimum 0-100 $\mu\text{g}/\text{m}^3$ and at maximum 0-10,000 $\mu\text{g}/\text{m}^3$ are possible. | yes       | 66   |
| 5.2.2 Negative output signals                      | Shall not be suppressed (living zero point).  | Negative measuring signals are displayed directly and are output correctly via the respective measured value outputs by the measuring system.  | yes       | 67   |
| 5.2.3 Analytical function                          | The relation between output signals and measured quantity shall be determined by regression calculation and represented by the analysis function.   | A statistically secured correlation could be proved between the reference method and the instrument reading.   | yes       | 68   |
| 5.2.4 Linearity                                    | The deviation of the group averages of the measured values for calibration function shall not exceed 5% of $B_1$ within the range of zero to $B_1$ . Within the range of zero to $B_2$ the deviation shall not exceed 1% of $B_2$ . | The test should be carried out according to minimum requirement 5.3.1 „Equivalency of the sampling system“ for particle measuring devices.   | yes       | 70   |
| 5.2.5 Detection limit                              | $B_0$ or less.  | The detection limit has been determined from the investigations to 1.33 $\mu\text{g}/\text{m}^3$ for device 1 (SN 17010) and to 1.09 $\mu\text{g}/\text{m}^3$ for device 2 (SN 17011).   | yes       | 70   |
| 5.2.6 Response time                                | Not more than 5% of the averaging time (equal to 180 s).  | Not applicable.  | -         | 73   |
| 5.2.7 Ambient temperature dependency of zero point | The measured value at zero point shall not exceed $B_0$ at $\Delta T_u$ by more than 15 K between +5°C and +20°C. Between +20°C and +40°C it shall not exceed $B_0$ at $\Delta T_u$ by more than 20 K.                              | Considering the values offered from the device, a maximum influence of the ambient temperature on the zero point of -1.6 $\mu\text{g}/\text{m}^3$ could be detected.   | yes       | 74   |

| Minimum requirement  | Specification  | Test result  | Fulfilled | Page |
|--|--|--|-----------|------|
| 5.2.8 Ambient temperature dependency of the measured value | The measured value in the range of B <sub>1</sub> shall not exceed 5% at ΔT <sub>u</sub> by more than 15 K between +5°C and +20°C. Between +20°C and +40°C it shall not exceed 5% at ΔT <sub>u</sub> by more than 20 K.                            | No deviations higher than > -0.2 % were determined for device 1 (SN 17010). For device 2 (SN 17011) deviations did not exceed 0.3 % of the initial value at 20 °C.   | yes       | 76   |
| 5.2.9 Zero drift   | Shall not exceed B <sub>0</sub> within 24h or during the maintenance interval.   | The detected values are all within the allowed limits of B <sub>0</sub> = 2 µg/m <sup>3</sup> during the maintenance interval.   | yes       | 78   |
| 5.2.10 Drift of the measured value                         | Shall not exceed 5% of B <sub>1</sub> within 24h or during the maintenance interval.   | The measuring system carries out a regular device-internal check of the sensitivity of the radiometric measurement during each measurement cycle. This test leads to no interruption of the ongoing measuring operation at all. The values for the drift of the sensitivity, determined within the scope of the test, were at maximum 0.5 % (SN 17010) respectively -0.5 % (SN 17011) in the maintenance interval. | yes       | 83   |
| 5.2.11 Cross sensitivity                                   | Shall not exceed B <sub>0</sub> in the range of zero point and 3% of B <sub>2</sub> within the range of B <sub>2</sub> .   | Not applicable.  | -         | 87   |
| 5.2.12 Reproducibility RD R <sub>D</sub>                   | R <sub>D</sub> ≥ 10 related to B <sub>1</sub> .  | Reproducibility RD in the field was 10 for the complete data set.  | yes       | 88   |
| 5.2.13 Hourly mean values                                  | Formation shall be possible.   | The formation of hourly averages for the component PM2.5 is not necessary for the monitoring of the relevant limit values, but possible..  | -         | 90   |
| 5.2.14 Mains voltage and frequency                         | Change of the measured value in the voltage interval (230 + 15/-20 V) does not exceed B <sub>0</sub> at B <sub>1</sub> . For mobile use, the change of the measured value does not exceed B <sub>0</sub> for the frequency interval (50 ± 2) Hz.   | No deviations > 0.1 % for device 1 (SN 17010) respectively > -0.1 % for device 2 (SN 17011) caused by mains voltage changes could be detected.   | yes       | 92   |
| 5.2.15 Power outage  | Uncontrolled emission of operating gas or reference gas for calibration shall be prevented. Device parameters shall be buffered against loss. Operating mode shall be secured on return of the mains voltage and the measurement shall be resumed. | All instrument parameters are protected against loss by buffering. The measuring system is in normal operating condition after return of power supply and continues independently the measurements with reaching the next hour.  | yes       | 94   |

| Minimum requirement  | Specification  | Test result   | Fulfilled | Page |
|--|--|---|-----------|------|
| 5.2.16 Operating states  | The AMS shall allow monitoring of system functions by telemetrically transmitted status signals.       | The measuring systems can be controlled and monitored extensively from an external PC via a modem.  | yes       | 95   |
| 5.2.17 Switchover  | The AMS shall allow manual and telemetric activation of measurement, function test and/or calibration. | Generally all necessary operations for functional check and calibration can be monitored directly at the device or via telemetric remote control.   | yes       | 96   |
| 5.2.18 Availability  | At least 90 %.   | The availability amounts to 97.9 % for device SN 17010 and 99.0 % for device SN 17011 without test-related outage times. Those included, the availability amounts to 94.6 % for device SN 17010 and 95.7 % for device SN 17011. | yes       | 98   |
| 5.2.19 Converter efficiency  | At least 95 %.   | Not applicable.   | -         | 99   |
| 5.2.20 Maintenance interval  | Preferably 28 days, at least 14 days.  | The maintenance interval is defined by necessary maintenance works and is 1 month.  | yes       | 100  |
| 5.2.21 Total uncertainty   | Compliance with the requirements on data quality [G10 to G12].   | The determined total uncertainties were 14.64 % respectively 15.29 % for U(c) and 10.05 % respectively 12.35 % for U( $\bar{C}$ ).  | yes       | 101  |
| <b>5.3 Requirements on measuring systems for particulate air pollution</b> |  |   |           |      |
| 5.3.1 Equivalency of the sampling system                                   | Shall be confirmed in comparison with the reference method according to EN 12341 [T2].                 | Not applicable for PM2.5 sampling systems. Please refer to chapter 7 of this report.  | -         | 104  |

| Minimum requirement                                       | Specification   | Test result  | Fulfilled | Page |
|---|---|--|-----------|------|
| 5.3.2 Reproducibility of the sampling system              | Shall be confirmed in the field for two identical sampling systems according to EN 12 341 [T2].   | Not applicable for PM2.5 sampling systems. Please refer to chapter 7 of this report.   | -         | 105  |
| 5.3.3 Calibration   | Comparative measurement with the reference method under field conditions according to EN 12 341 [T2]; Relation between the gravimetrically determined reference concentration and the measured signal shall be determined as a continuous function. | Refer to Module 5.2.3.   | -         | 106  |
| 5.3.4 Cross sensitivity                                   | Not more than 10% of B <sub>1</sub> .   | No interferences caused by humidity, contained in the measured medium, which led to deviations of more than 1.2 µg/m <sup>3</sup> between nominal value and measured signal, could be detected. Negative influences on the measured value caused by varying relative air humidity were not detected. | yes       | 108  |
| 5.3.5 Daily averages                                      | 24 h mean values shall be possible; time needed for filter changes shall not exceed 1% of the averaging time.   | With the described system configuration and with a measurement cycle of 60 min, the formation of valid daily averages on the basis of 24 single measurements is possible.  | yes       | 110  |
| 5.3.6 Constancy of sample volumetric flow                 | At least 3% of the nominal value during sampling and at least 5% for instantaneous values.  | All determined daily averages deviate less than ± 3 %, all individual values less than ± 5 % from the nominal value.   | yes       | 112  |
| 5.3.7 Tightness of the sampling system                    | Leakage shall not exceed 1% of the sampling volume.   | The maximum determined leakages have been 1.8 % for device 1 (SN 17010) as well as 2.4 % for device 2 (SN 17011). According to the minimum requirement, the leak rate shall not be greater than 1 % of the sample flow rate.   | no        | 116  |
| 5.4 Requirements for multiple-component measuring systems | Shall be fulfilled for each individual component during simultaneous operation of all measuring channels; generation of hourly mean values shall be ensured during sequential operation.  | Not applicable.  | -         | 117  |

| Minimum requirement  | Specification   | Test result  | Fulfilled | Page |
|--|---|--|-----------|------|
| Additional test criteria according to Guide „Demonstration of Equivalence of Ambient Air Monitoring Methods“ |   |  |           |      |
| Determination of the in-between-instrument uncertainty $u_{bs}$ [9.5.2.1]                                    | Shall be determined in the field for two identical systems according to point 9.5.2.1 of guide „Demonstration of Equivalence of Ambient Air Monitoring Methods“.  | The in-between-instrument uncertainty between the candidates $u_{bs}$ is at maximum $1.57 \mu\text{g}/\text{m}^3$ and thus below the required value of $2.5 \mu\text{g}/\text{m}^3$ .    | yes       | 119  |
| Calculation of the expanded uncertainty of the instruments [9.5.2.2-9.5.6]                                   | Determination of the expanded uncertainty of the devices under test according to point 9.5.2.2ff of Guide „Demonstration of Equivalence of Ambient Air Monitoring Methods“.   | The determined uncertainties WCM are below the specified expanded relative uncertainty $W_{dqo}$ of 25 % (particulate matter) for all data sets without the usage of corrective factors. | yes       | 126  |
| Application of correction factors or terms [9.7]   | Correction factors may be applied if the highest expanded uncertainty which has been calculated exceeds the relative expanded uncertainty specified in the requirements on the data quality of ambient air quality measurements according to EU Guideline [7].<br>The corrected values must comply with the requirements according to point 9.5.2.2ff. of Guide „Demonstration of Equivalence of Ambient Air Monitoring Methods“. | The candidate systems fulfil the requirements on the data quality of ambient air quality measurements during the test already without application of correction factors.                 | yes       | 139  |



### 3 Description of the tested measuring system

#### 3.1 Measuring principle

The ambient air measuring system BAM-1020 is based on the measuring principle of beta-attenuation.

The principle of the radiometric determination of mass is based on the physical law of attenuation of beta-rays when passing a thin layer of material. There is the following relationship:

$$c \left( \frac{\mu\text{g}}{\text{m}^3} \right) = \frac{10^6 A (\text{cm}^2)}{Q \left( \frac{\text{l}}{\text{min}} \right) \Delta t (\text{min}) \mu \left( \frac{\text{cm}^2}{\text{g}} \right)} \ln \left( \frac{I_0}{I} \right)$$

with:

|       |                                 |            |   |
|-------|---------------------------------|------------|---|
| C     | particle-mass concentration     | A          | sampling area for particles (filter spot) |
| Q     | sampling flow rate              | $\Delta t$ | sampling time                             |
| $\mu$ | mass absorption coefficient     | $I_0$      | beta count rate at the beginning (clean)  |
| I     | beta count at the end (collect) |            |   |

The radiometric determination of mass is calibrated in the factory and is checked within the scope of internal quality assurance hourly at the zero point (clean filter spot) and at the reference point (built-in reference foil) during operation. With the help of the generated data, measured values at zero and reference point can be easily affiliated. They can be compared with any stability requirements (drift effects) respectively with the nominal value for the reference foil (factory setting).

### 3.2 Functionality of the measuring system

The particle sample passes the PM<sub>2.5</sub> pre-separator, consisting of a PM<sub>10</sub>-sampling inlet and a PM<sub>2.5</sub> Sharp Cut Cyclone SCC, with a flow rate of 1 m<sup>3</sup>/h and arrives via the sampling tube at the measuring instrument BAM-1020.

Within the scope of the test work, the measuring system was operated with the sample heater BX-830 (Smart Inlet Heater).

The heater can be controlled with the help of two control process variables respectively with their combination:

1. The relative humidity RH at the filter tape (factory setting: 45 %)
2. The temperature difference Delta-T between ambient temperature and temperature at the filter tape (factory setting: 5 °C)

As soon as the relative humidity RH is 1% below the nominal value or the critical value for Delta-T is reached respectively is exceeded, the heater is switched off. Thereby the criterion for Delta-T is the striking one, which means, that in case the relative humidity RH is above the nominal value, but the value for Delta-T is above or equal the critical value, the heater is switched off.

During the test work, the candidates were installed in an air-conditioned measuring cabinet. For this configuration, the controlling of the heater with the help of the Delta-T criterion is not reasonable. For this reason, the heater was only controlled with the help of the parameter relative humidity RH during the complete test work.

The particles arrive at the measuring instrument and will be separated at the glass fiber filter tape for the radiometric measurement.

One measurement cycle (incl. automatic check of the radiometric measurement) consists of the following steps (setting: measuring time for radiometry 8 min):

1. The initial count of the clean filter tape  $I_0$  is performed at the beginning of the cycle for a period of eight minutes.
2. The filter tape is advanced four windows and the sampling (vacuum pumping) begins on the spot in which  $I_0$  was just measured. Air is drawn through this spot on the filter tape for approximately 42 minutes.
3. At the same time the second count  $I_1$  occurs (at a point on the tape 4 windows back) for a period of eight minutes. The purpose of the measurement is to perform the verification for instrument drift caused by varying external parameters such as temperature and relative humidity. A third count  $I_2$  occurs with the reference membrane extended over the same place on the tape. Eight minutes before the end of sampling time, another count  $I_{1x}$  occurs on the same point of the tape. With the help of  $I_1$  and  $I_{1x}$ , the stability at the zero point can be monitored.



4. After sampling, the filter tape is moved back four windows to measure the beta ray absorption through the section that has collected dust ( $I_3$ ). Finally the concentration calculation is performed to complete the cycle.
5. The next cycle begins with step 1

Figure 1 gives an overview on the sampling- and measurement part of the BAM-1020.

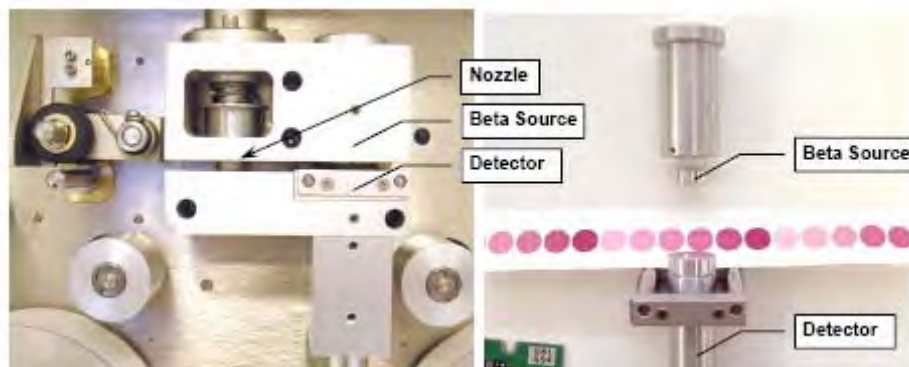

Figure 1: *BAM-1020 – Overview on sampling and measurement part*

During the suitability test work, a cycle time of 60 min with a time need of 8 min for the radiometric measurement was set.

Therefore the cycle time consists of 2 x 8 min for the radiometric measurement ( $I_0$  &  $I_3$ ) as well as approximately 1-2 min for filter tape movements. Thus the effective sampling time is around 42 min.

### 3.3 AMS scope and layout

The ambient air measuring system BAM-1020 is based on the measuring principle of beta-attenuation.

The tested measuring system consists of the PM<sub>10</sub>-sampling inlet BX-802, the PM<sub>2.5</sub> Sharp Cut Cyclone SCC BX-807, the sampling tube, the sample heater BX-830, the combined pressure and temperature sensor BX-596 (incl. radiation protection shield, as an alternative the ambient temperature sensor BX-592), the vacuum pump BX-17010, the measuring instrument BAM-1020 (incl. glass fiber filter tape), the respective connecting tubes and lines as well as adapters, the roof flange as well as the manual in English language.

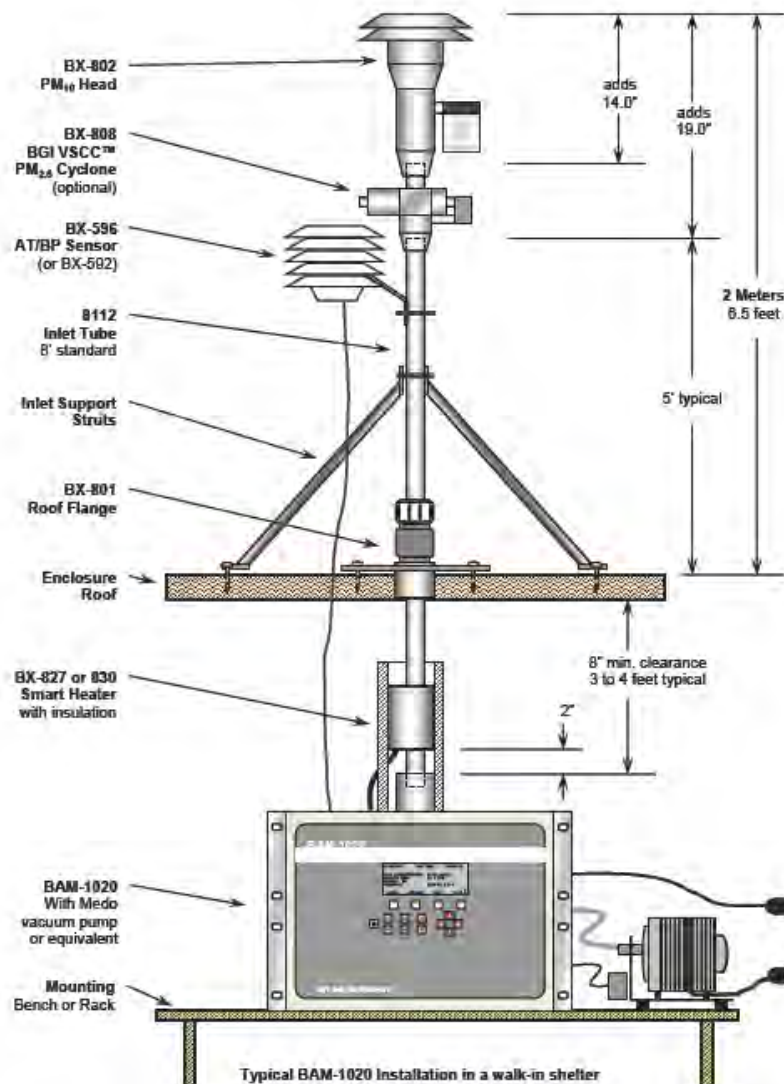

*Figure 2: Overview measuring system BAM-1020  
(here instead of PM<sub>2.5</sub> SCC BX-807 with PM<sub>2.5</sub> VSCC BX-808 (configuration for  
US-EPA approval))*

The measuring instrument BAM-1020 offers the possibility to connect up to 6 different sensors at the available analogue inputs. For example, besides the combined pressure and temperature sensor BX-596 respectively the ambient temperature sensor BX-592, the connection of sensors for the air pressure BX-594, the wind direction (BX-590), for the wind velocity (BX.591), for the air humidity (BX-593) as well as for solar radiation (BX-595) is imaginable.

Concerning the sampling inlets, an US-PM<sub>10</sub> sampling inlet (type: BX-802, manufacture and design according to Guideline EPA 40 CFR Part 50) is available. The sampling inlet serves as a pre-separator for the suspended particulate matter in the fraction PM<sub>10</sub>. Directly downstream of the PM<sub>10</sub> sampling inlet, a Sharp Cut Cyclone SCC (BX-807) is used for the separation of particles in the range of 2.5 µm to 10 µm. The instruments are operated with a constant, regulated volume flow of 16.67 l/min = 1.0 m<sup>3</sup>/h.

As an alternative option, it is possible to use TSP-sampling inlets or PM<sub>10</sub>-sampling inlets without SCC.



*Figure 3: US- PM-sampling inlet BX-802 for BAM-1020*



*Figure 4: Sharp Cut Cyclone SCC BX-807 for BAM-1020*



*Figure 5: Sampling inlet BX-802 + SCC BX-807*

The sampling tube connects the sampling inlet and the measuring instrument. The length of the sampling tube was 1.65 m during the test, differing lengths can be manufactured with respect to the local conditions.

The sample heater BX-830 is installed at the lower end of the sampling tube (approximately 50 mm above the instrument inlet of BAM-1020). The operation of the heating systems is performed as described in point 3.2 Functionality of the measuring system.



*Figure 6: Sample heater BX-830*

The vacuum pump BX-17010 is connected to the measuring instrument at the end of the sampling path with a hose. The pump is controlled via the measuring system on actual volume in relation to the ambient conditions (Mode ACTUAL)

The measuring system BAM-1020 contains, besides the radiometric measurement part, the glass fiber filter tape incl. transport system, large parts of the pneumatic system (flow measurement by mass flow sensor), the control unit of the sample heater and all necessary electronic parts and microprocessors for the control and operation of the measuring system as well as for the communication with the system.



Report on the suitability test of the ambient air quality measurement system BAM-1020 with PM2.5 pre-separator of the company Met One Instruments, Inc. for the component suspended particulate matter PM2.5,  
Report No.: 936/21209919/A

Page 29 of 285



*Figure 7: Measuring instrument BAM-1020*



*Figure 8: Measuring systems BAM-1020, installed in measurement cabinet ( 2 candidates of suitability test + 1 candidate for experimental purposes (configuration of heater)*

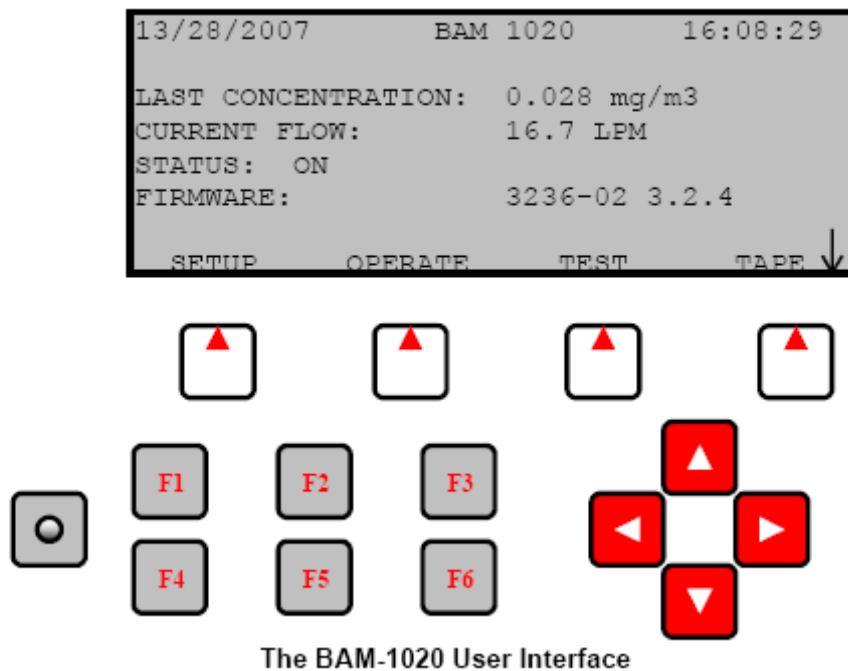

*Figure 9: Vacuum pump*



*Figure 10: Front view BAM-1020, front cover opened*

The handling of the measuring systems is done via a soft keypad in combination with a display at the front of the instrument. The user is able to get stored data, to change parameters and to perform several tests to control the functional capability of the measuring system.



The BAM-1020 User Interface

Figure 11: Display + soft keypad of BAM-1020

The main screen of the user display can be found on the top level – here the actual time and date, the last 1h-concentration value, the actual flow rate, the software version as well as the status of the instrument are displayed.

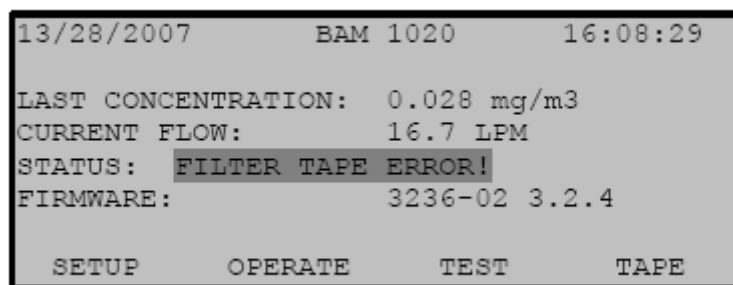

Figure 12: Main screen of user display



Via the function keys F1 to F6, different functions can be easily called from the top level. For example it is possible, to access actual information on the last concentration values as well as measured values from other sensors (ambient temperature), error messages and on stored data for the measurements of the last ten days.

Starting from the top level, one can furthermore access on the following sub-menus via soft key:

1. Menu „SETUP“ (Press soft key „SETUP“):

The configuration and setting of parameters of the measuring system is done in the menu „SETUP“. The user can do settings for parameters like for instance date/time, sampling time, measuring range, flow rate, output of measured values (actual or standard conditions), change of pass word, interfaces, external sensors and sample heater.

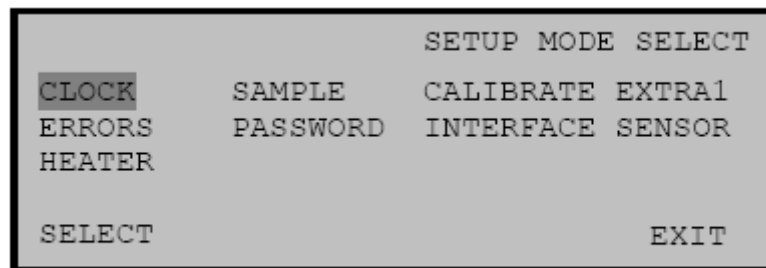

The SETUP Menu

Figure 13: Menu „SETUP“

2. Menu „OPERATION“ (Press soft key „OPERATION“):

In the menu „OPERATION“, it is possible to call up information during the operation of the measuring system. As long as the operating mode is switched on „ON“, the measuring system will be in operation according the settings. An interruption of the ongoing measurement can be done either by switching the operating mode to „OFF“, by calling up the menus „SETUP“, „TEST“ or „TAPE“ during the ongoing operation or in case of a severe malfunction (e.g. crack of filter tape).

```
11/15/2006  OPERATE MODE  14:13:07

      ↑ = ON
      ↓ = OFF
Operation Mode: ON
      Status: ON

NORMAL      INST      AVERAGE      EXIT
```

The OPERATE Menu

Figure 14: Menu „OPERATION“

In the submenus NORMAL, INST and AVERAGE, the actual measured values of the system can be displayed in different manner. The most usual way of displaying is the “NORMAL” screen. Here the user can watch the most important parameters relevant for operation.

```
11/15/2006      Normal Mode      11:27:54

                                Flow(STD): 16.7 LPM
                                Flow(ACTUAL): 16.7 LPM
LAST C: 0.061 mg/m3              Press: 764 mmHg
LAST m: 0.806 mg/cm2            RH: 37 %
                                Heater: OFF
                                Delta-T: 4.2 C
STATUS: SAMPLING                EXIT
```

The NORMAL Menu

Figure 15: Screenshot „NORMAL“

3. Menu „TEST“ (Press soft key „TEST“):  
In the menu „TEST“, the user can perform several tests for checking the hardware and components, e.g. a check of the radiometric measurement (reference foil test), a check of the flow rate or a calibration of temperature and pressure sensors as well as of the flow rate is possible.

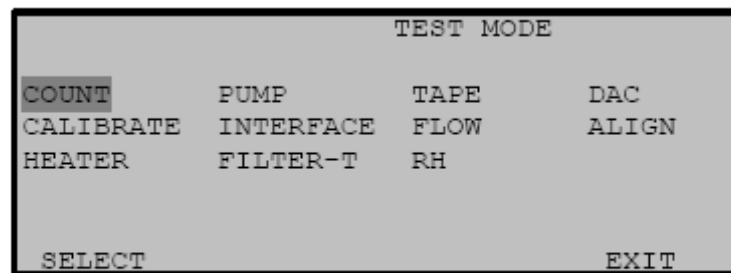

**The TEST Menu**

Figure 16: Menu „TEST“

4. Menu „TAPE“ (Press soft key „TAPE“):  
In the menu „TAPE“, it is possible to start at any time (= aborting the ongoing measurement) an extensive self test of the measuring system. In this self test, which takes around 4 min, several mechanic parts (e.g. the filter transport system) are tested on functional capability and the flow rate and the condition of the filter tape (tension, crack of tape) are checked. In case of irregularities or unallowable deviations, an error message „FAIL“ is displayed and a specific search for the problem can start. If the self test can be performed without problems, the status „SELFTEST PASSED“ is displayed and the operation can start. The performance of this test is generally recommended after each restart of the measurement after abort, in each case after a change of the filter tape.

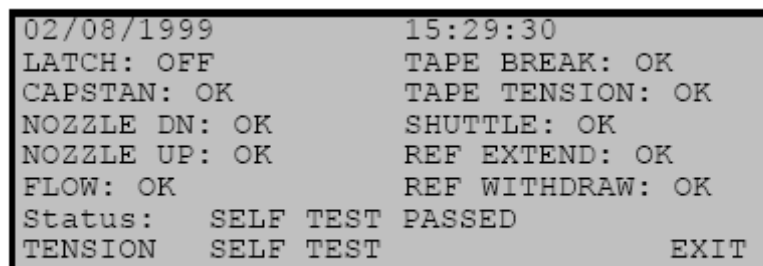

**Self-Test Status Screen**

Figure 17: Screen shot „TAPE/SELF TEST“

Besides the direct communication via keys/display, there are numerous possibilities to communicate via different analogue outputs, relais (status and alarm messages) as well via RS-232 interfaces. The RS232-interfaces allow the connection of printer, PC and modem. The communication with the instrument can be done for instance with the software HyperTerminal.

The serial interface #1 serves form data transfer and transmission of the instrument status. This interface together with a modem is often used for remote control.

The following system menu is available:

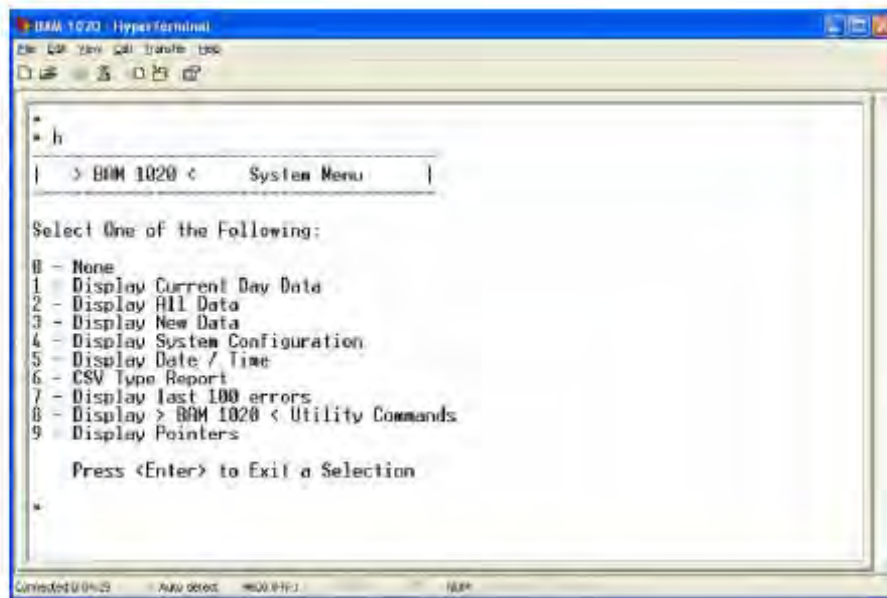

Figure 18: Communication via serial interface #1 – system menu



Report on the suitability test of the ambient air quality measurement system BAM-1020 with PM2.5 pre-separator of the company Met One Instruments, Inc. for the component suspended particulate matter PM2.5, Report No.: 936/21209919/A

Via the system menu (number 4 – Display System Configuration) it is furthermore possible to display and print out the actual parameter setting of the BAM-1020 for the purpose of information and diagnosis (refer to Figure 19)

```

BAM 1020 Settings Report
2/18/2009 9:40

Station ID          10

Firmware           3236-07 5.0.1

  K                0.933
  BKGD             -0.0014
  usw              0.3
  ABS              0.828
  Range            1
  Offset           -0.015
  Clamp            -0.015
Conc Units         ug/m3
Conc Type          ACTUAL
Count Time         8

  Cv               1.01
  Qo               0
Flow Type          ACTUAL
Flow Setpt        16.7
Std Temp          25
High Flow Alarm   20
Low Flow Alarm    10

Heat Mode          AUTO
Heat OFF (%)       6
  RH Ctrl          YES
  RH SetPt         45
  RH Log           YES
  DT Ctrl          NO
  DT SetPt         99
  DT Log           YES

BAM Sample         42
MET Sample         60
Cycle Mode         STANDARD
Fault Polarity     NORM
Reset Polarity     NORM
Maintenance        OFF

EUMILRNFPDCT
0

  AP              150
  Baud Rate       9600
  Printer Report  2
  e3              0
  e4              15

Channel            1          2          3          4          5          6
Sensor ID         255         2          255         255         255         35
Channel ID        255         254        255         255         255         254
Name              BP          WS          WS          RH          Delta      AT
Units             mmH         MPS         MPS         %           C           C
Prec              1          1          1          0           1           1
FS Volts          2.5        1          1          0.5         2.5         2.5
Mult              300        44.7       44.7       32          -147.1      95
Offset            525        0          0          -26         95.8       -40
Vect/Scalar       S          S          S          S           S           S
Inv Slope         N          N          N          N           N           N

Calibration       Offset      Slope
Flow              0.089     0.973
AT                0
BP                0
RH                -0.213
FT                0
  
```

Figure 19: Typical print out of the parameter setting of BAM-1020

The serial interface #2 serves only as a printer output and can be connected to a printer or a PC. It offers the possibility of continuous recording of actual information on the measurements.

For external check of the zero point of the measuring system and for determination of the background value BKGD (offset correction for concentration values) according to the manual chapter 7.7, a zero filter (BX-302, Zero Filter Calibration Kit) is mounted at the device inlet. The usage of this filter allows the provision of particle-free air.



*Figure 20: Zero filter BX-302 during field application*

With the available valve, it is also possible to check the tightness of the measuring system with the zero filter BX-302 according to the manual chapter 5.3 .

For the audit of the inlet flow rate according to the manual chapter 5.6, an adapter BX-305 (Flow Inlet Adapter Kit) is available. As this kit is compliant in manufacture to the zero filter kit BX-802 except for the HEPA-filter itself, it is also possible to check the tightness of the measuring system with its available valve according to the manual chapter 5.3.

Table 2 contains an overview of important technical specifications of the ambient air measuring system BAM-1020.

*Table 2: Device-related data BAM-1020 (Manufacturer's data)*

| <b>Dimensions / weight</b>             |  | <b>BAM-1020</b>   |                               |
|--|--|---|-------------------------------|
|  | Measuring system   | 310 x 430 x 400 mm / 24.5 kg (without pump)   |                               |
|  | Sampling line  | 1.65 m (different lengths available)  |                               |
|  | Sampling inlet   | BX-802 (US)   |                               |
| <b>Energy supply</b>                   |  | 100/115/230 V, 50/60 Hz   |                               |
| <b>Power consumption</b>               |  | 75 W, main unit   |                               |
| <b>Ambient conditions</b>              |  |   |                               |
|  | Temperature  | -30 - +60 °C (manufacturer's data)<br>+5 - +40 °C in suitability test   |                               |
|  | Humidity   | non condensing  |                               |
| <b>Sampling flow rate</b>              |  | 16.67 l/min = 1 m <sup>3</sup> /h   |                               |
| <b>Radiometry</b>                      | <b>Radiator</b>  | <sup>14</sup> C, <2,2 MBq (< 60 µCi)  |                               |
|  | <b>Detector</b>  | Scintillation probe   |                               |
| <b>Check procedure</b>                 |  | Hourly internal zero and reference point checks (reference foil), deviations from the nominal value are recorded.                   |                               |
| <b>Parameter of filter change</b>      |  |   |                               |
|  | Measurement cycle (cycle time)                                   | 1 min – 200 min   | Default: 60 min               |
|  | Measuring time radiometry  | selectable 4,6 or 8 min   | for PM <sub>2.5</sub> : 8 min |
|  | Sampling time  | depending on measuring time radiometry 50, 46 or 42 min<br>for PM <sub>2.5</sub> : 42 min   |                               |
| <b>Parameter sample heater BX-830</b>  |  |   |                               |
|  | maximum temperature difference filter tape – ambient temperature | Default: 5°C  |                               |
|  | Nominal value for relative humidity at filter tape               | Default: 45 %   |                               |
| <b>Buffer capacity (internal)</b>      |  | approx. 180 days for 1h-measuring values  |                               |
| <b>Analogue output</b>                 |  | 0 – 1 (10) V or 0 – 16 mA / 4 – 20 mA – can be set to 0-0.100, 0.200, 0.250, 0.500, 1.000, 2.000, 5.000 or 10.000 mg/m <sup>3</sup> |                               |
| <b>Digital output</b>                  |  | 2 x RS 232 – interface for data transmission and remote control   |                               |
| <b>Status signals / error messages</b> |  | available, for an overview refer to chapter 8 in the manual   |                               |



## 4 Test program

### 4.1 General

The suitability test has been performed with two identical devices of the serial numbers SN 17010 and SN 17011.

The test was performed with software version 3236-07 5.01 (Status July 2008).

The software has been constantly developed and optimized up to version 3236-07 5.0.10 during the test program. The changes up to version 3236-07 5.0.5 have been already presented in a statement and have been assessed positively by the responsible working group „Test reports“. The additional changes from version 3236-07 5.0.5 to version 3236-07 5.0.10 are described in Figure 64 on page 178 in the appendix.

No influences on the system performance are expected from the changes which were made on the software up to version 3236-07 5.0.10.

The laboratory tests for the determination of system characteristics were followed by a field test of several months at different test sites.

All concentrations, determined under operation conditions, are presented in  $\mu\text{g}/\text{m}^3$ .

No structural changes were made on the candidates during the suitability testing.

The following report comprises a description of each minimum requirement according to standards [1,2,3,4] in number and wording.

### 4.2 Laboratory test

The laboratory test was carried out with two identical devices of BAM-1020 measuring system with the serial numbers SN 17010 and SN 17011.

According to the Standards [1,2,3], the following test program was specified for the laboratory test:

- Description of system functions
- Determination of detection limits
- Determination of the dependence of zero point / sensitivity on ambient temperature
- Determination of the dependence of zero point / sensitivity on the system voltage

The following devices were used to determine the system characteristics during laboratory test:

- Climatic chamber (temperature range from  $-20\text{ °C}$  to  $+50\text{ °C}$ , precision better than  $1\text{ °C}$ )
- Adjustable isolating transformer
- Zero filter kit BX-302 for external zero point check.
- Reference foil (built-in fixed in the devices)

The measured values were recorded in the devices. The stored measured values were read *via* Hyperterminal with the help of a notebook.

Section 6 describes the laboratory tests and the results.

### 4.3 Field test

The field test was carried out with two identical systems of the serial numbers:

Device 1: SN 17010  
Device 2: SN 17011

The following test program was specified for the field test:

- Determination of the comparability of the candidates according to the Guide “Demonstration of Equivalence of Ambient Air Monitoring Methods”
- Determination of the comparability of the candidates and the reference methods according to the Guide “Demonstration of Equivalence of Ambient Air Monitoring Methods”
- Sampling flow stability check
- Determination of the calibration efficiency and analysis function record
- Determination of reproducibility
- Determination of temporal changes of zero point and sensitivity
- Leak test on the sampling system
- Inspection of the dependency of the measured values on humidity
- Determination of the maintenance interval
- Determination of availability
- Determination of the total uncertainty of the candidates.

The following devices were used for the field test:

- Measurement cabinet of the UK partners, air-conditioned to approx. 20 °C
- Weather station (WS 500 of the company ELV Elektronik AG) for the determination of meteorological characteristics such as air temperature, air pressure, air humidity, wind velocity, wind direction and rainfall
- Two reference equipment LVS3 for PM<sub>2.5</sub> according to point 5
- Gas meter, dry
- Mass flow rate measuring device Type 4043 (Manufacturer: TSI)
- Measuring device Metraster 5 (Manufacturer: company Gossen Metrawatt) for the determination of power consumption
- Zero filter kit BX-302 for particle-free air generation
- Reference foil (built-in fixed in the devices)

Two BAM-1020 systems and two reference equipment for PM<sub>2.5</sub> were simultaneously operated for 24 h each during the field test. The reference equipment for PM<sub>2.5</sub> was operating discontinuously, i.e. the filters must be manually changed after sampling.

The impaction plates of the PM<sub>2.5</sub> sampling inlets were cleaned and greased with silicone grease approx. every 2 weeks to ensure a clean separation and deposition of particles. The PM<sub>10</sub> sampling inlets BX-802 and the PM<sub>2.5</sub> cyclones BX-807 of the candidates were cleaned approx. every 4 weeks. In general the sampling inlet shall be cleaned according to the manufacturer's instructions by also taking into account the local suspended particulate matter concentrations.

The flow rate was tested on each candidate and each reference device prior to and after each change of location with a dry gasmeter respectively a mass flow meter, which was connected to the air inlet of the systems *via* hose assembly for this reason.

### Measurement sites and site of the measuring devices

The candidate systems as well as the reference systems have been installed in the field test in that way, that only the sampling inlets are arranged outside of the measurement cabinet above its roof. The central units of both candidate systems and of both reference systems been installed inside the climate-controlled measurement cabinet. The connection of the central units with the sampling inlets was realized for the BAM-1020 -systems with the sampling tube and for the LVS3 it was realized with an extension tube.

The field test was carried out at the following sites:

*Table 3: Field test site*

| No. | Measurement site                                    | Period            | Characterisation                        |
|-----|---|-------------------|---|
| 1   | Teddington (UK),<br>Summer                          | 07/2008 – 11/2008 | Urban background                        |
| 2   | Cologne, parking<br>lot, Winter                     | 12/2008 – 04/2009 | Urban background                        |
| 3   | Bornheim, park-<br>ing lot at motor-<br>way, Summer | 08/2009 – 10/2009 | Rural structure + traffic<br>influences |
| 4   | Teddington (UK),<br>Winter                          | 12/2009 – 02/2010 | Urban background                        |

Figure 21 to Figure 24 present the course of the PM-concentrations at the field test sites (recorded by the reference equipment).

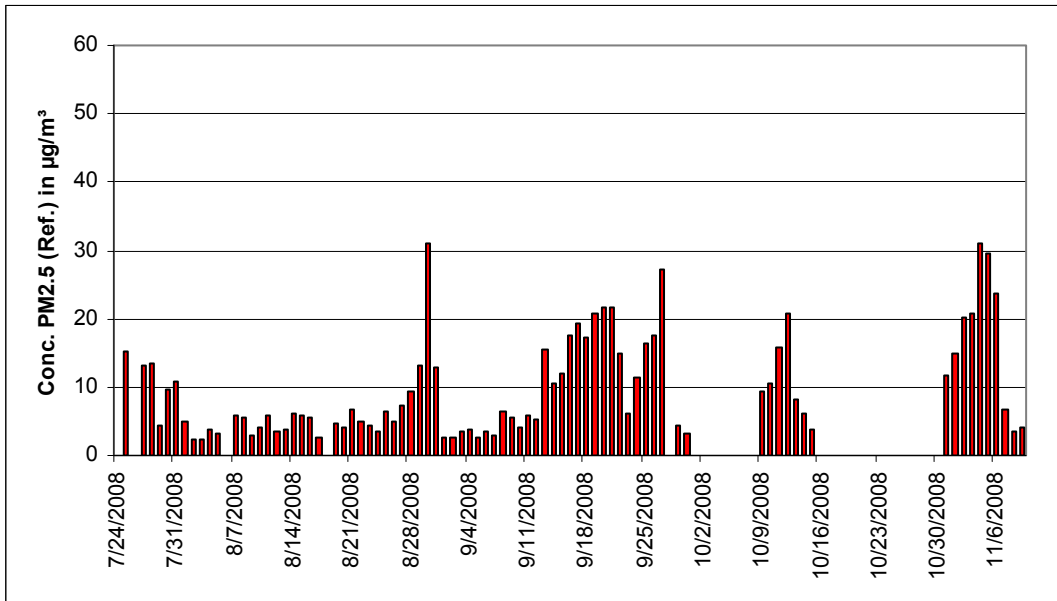

Figure 21:  $PM_{2.5}$  concentration (reference) at the site „Teddington, Summer“

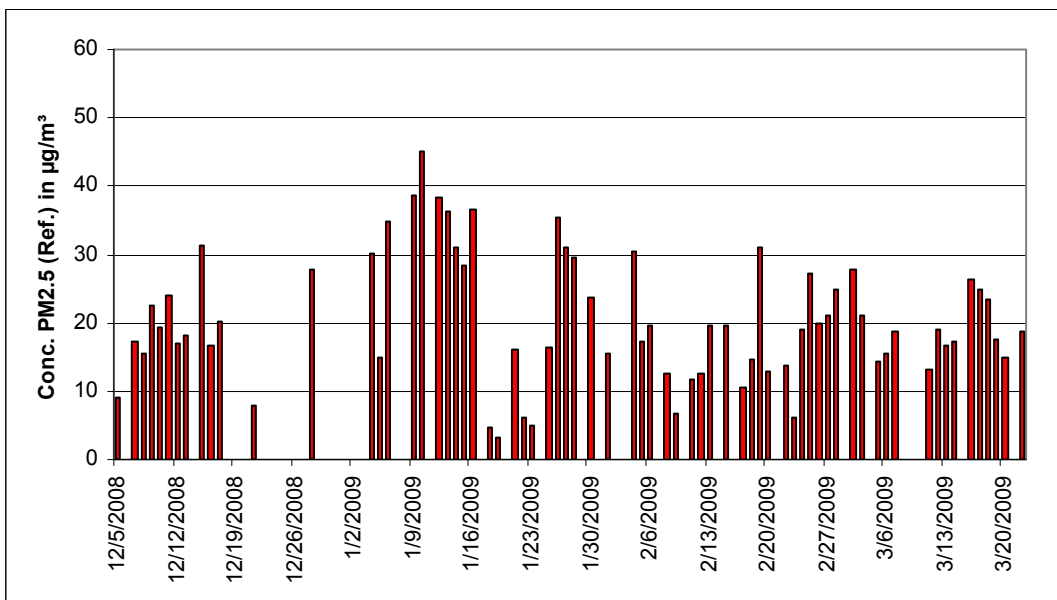

Figure 22:  $PM_{2.5}$  concentration (reference) at the site „Cologne, Winter“

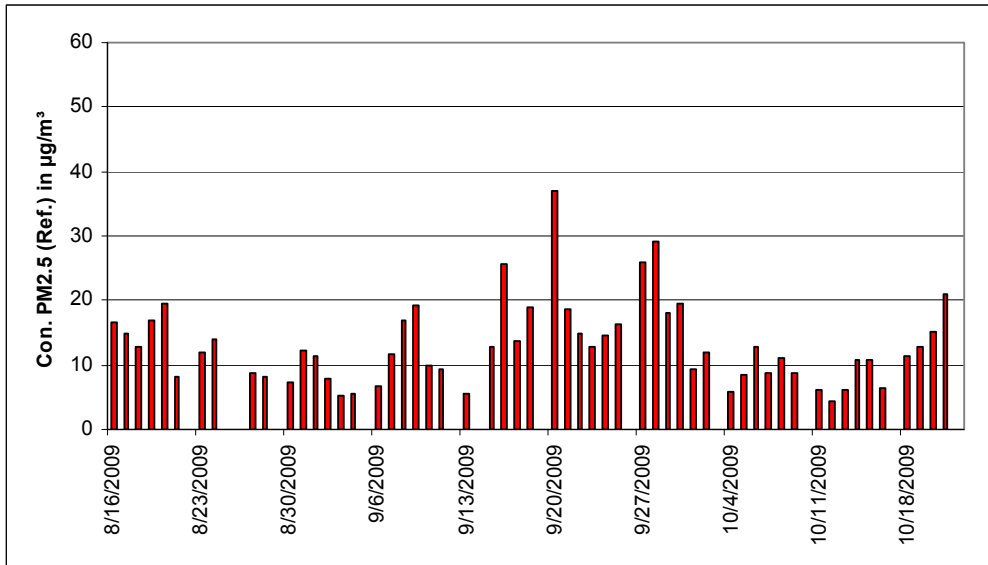

Figure 23: *PM<sub>2.5</sub> concentration (reference) at the site „Bornheim, Summer“*

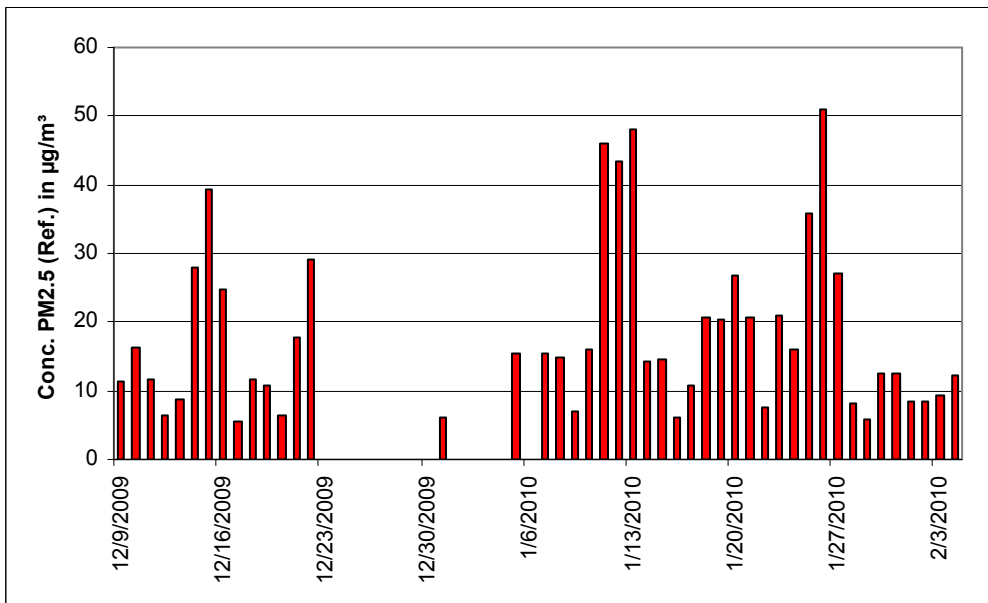

Figure 24: *PM<sub>2.5</sub> concentration (reference) at the site „Teddington, Winter“*

The following figures show the measuring container at the field test sites in Teddington, Cologne (parking lot) and Bornheim (motorway parking lot).

Report on the suitability test of the ambient air quality measurement system BAM-1020 with PM2.5 pre-separator of the company Met One Instruments, Inc. for the component suspended particulate matter PM2.5,  
Report No.: 936/21209919/A



*Figure 25: Field test site Teddington*



*Figure 26: Field test site Cologne, parking lot*





Figure 27: Field test site Bornheim, motorway parking lot

A data acquisition device for meteorological characteristics was installed to the container in addition to the devices for dust measurement. Data for air temperature, air pressure, air humidity, wind velocity, wind direction and rainfall were continuously collected and saved as half-hourly averages.

The installation of the measuring cabinet as well as the arrangement of the sampling probes were characterised by the following measures:

- Container roof: approx. 2.5 m
- Sampling height for candidates / reference devices: approx. 1.13 / 0.51 m above container roof (resp. approx. 3.63 / 3.01 m above ground)
- Vane: approx. 4.5 m above ground

The following Table 4 presents an overview on the most important meteorological data of the four sites and the particulate matter relations during the test. No meteorological data are available for the location in Teddington, UK, prior to September 17th 2008. Refer to section 5 and 6 for detailed results.

**Table 4:** *Ambient conditions at the field test site (daily averages)*

|  | Teddington (UK),<br>Summer* | Cologne,<br>parking lot<br>Winter | Bornheim,<br>motorway park-<br>ing lot,<br>Summer | Teddington (UK),<br>Winter |
|--|-----------------------------|-----------------------------------|---|----------------------------|
| No. of paired values<br>Reference PM <sub>2.5</sub> (total)                        | 81                          | 75                                | 58  | 45                         |
| <b>PM<sub>2.5</sub> fraction from PM<sub>10</sub> under ambient conditions [%]</b> |                             |                                   |   |                            |
| Range  | 22.3 – 83.2                 | 42.4 – 92.9                       | 40.3 – 81.8                                       | 41.6 – 90.6                |
| Average  | 53.9                        | 73.8                              | 60.5  | 70.3                       |
| <b>Air temperature [°C]</b>  |                             |                                   |   |                            |
| Range  | 4.2 – 15.4                  | -14 – 17.8                        | 3.3 – 25.3  | -3.7 – 9.8                 |
| Average  | 11.2                        | 3.9                               | 15.4  | 2.7                        |
| <b>Air pressure [hPa]</b>  |                             |                                   |   |                            |
| Range  | 984 – 1016                  | 971 – 1030                        | 995 – 1022  | 984 – 1037                 |
| Average  | 1000                        | 1008                              | 1010  | 1008                       |
| <b>Rel. Air humidity [%]</b>   |                             |                                   |   |                            |
| Range  | 64 – 95                     | 48 – 85                           | 44 – 82   | 77 – 98                    |
| Average  | 81.4                        | 71.4                              | 68.1  | 89.6                       |
| <b>Wind velocity [m/s]</b>   |                             |                                   |   |                            |
| Range  | 0.0 – 1.8                   | 0.0 – 6.9                         | 0.0 – 4.4   | 0.0 – 2.4                  |
| Average  | 0.5                         | 2.0                               | 0.4   | 0.6                        |
| <b>Rainfall [mm]</b>   |                             |                                   |   |                            |
| Range  | not available               | 0.0 – 26.9                        | 0.0 – 20.0  | 0.0 – 11.7                 |
| Average  |                             | 2.5                               | 1.9   | 1.8                        |

\* Weather data available after 2008-09-17



## Sampling period

EN 14907 defines a sampling period of 24 h ± 1 h.

While the sampling period was constantly set to 24 h during field test (10:00 – 10:00 (Teddington and Cologne) and 7:00 – 7:00 (Bornheim), it was reduced for some laboratory tests to obtain a higher number of measured values.

## Data handling

All paired reference values determined during the field tests were subject to statistical testing according to Grubbs (99 %) to prevent influences of obviously implausible data on the measuring results. Paired values which are identified as significant outliers can be discarded until the critical value of the test statistic is exceeded. The actual version of the Guide [4] stipulates, that not more than 2.5 % of the paired values in total for each field test site may be identified and removed as outliers.

Within the scope of the „Combined MCERTS and TÜV PM Equivalence Testing“ program we agreed with our British partners not to discard any measured value for the candidates unless the implausibility is caused due to technical reasons. Therefore no values for the candidates were discarded during the whole test.

Table 5 presents an overview on the paired values (reference measurement) which were identified and removed as significant outliers for each location.

*Table 5: Overview on outliers – reference, measured component PM<sub>2.5</sub>*

| Graph Number | Site              | Sampler                  | Number of data-pairs | Maximum Number that can be deleted | Number Identified | Number Deleted | Number of data-pairs remaining |
|--------------|-------------------|--------------------------|----------------------|------------------------------------|-------------------|----------------|--------------------------------|
| A            | Teddington Summer | PM <sub>2.5</sub> Leckel | 83                   | 2                                  | 2                 | 2              | 81                             |
| B            | Cologne Winter    | PM <sub>2.5</sub> Leckel | 77                   | 2                                  | 3                 | 2              | 75                             |
| C            | Bornheim Summer   | PM <sub>2.5</sub> Leckel | 60                   | 2                                  | 2                 | 2              | 58                             |
| D            | Teddington Winter | PM <sub>2.5</sub> Leckel | 46                   | 1                                  | 2                 | 1              | 45                             |

The following data pairs have been removed:

Table 6: Removed data pairs reference PM<sub>2.5</sub> according to Grubbs

| Test site          | Date       | Reference 1 [ $\mu\text{g}/\text{m}^3$ ] | Reference 2 [ $\mu\text{g}/\text{m}^3$ ] |
|--------------------|------------|--|--|
| Teddington, Summer | 07/24/2008 | 32.5                                     | 27.8                                     |
| Teddington, Summer | 07/26/2008 | 16.1                                     | 13.8                                     |
| Cologne, Winter    | 01/20/2009 | 11.2                                     | 8.4                                      |
| Cologne, Winter    | 02/03/2009 | 34.0                                     | 37.4                                     |
| Bornheim, Summer   | 08/25/2009 | 13.8                                     | 20.3                                     |
| Bornheim, Summer   | 10/22/2009 | 27.0                                     | 24.3                                     |
| Teddington, Winter | 01/06/2010 | 13.5                                     | 16.0                                     |

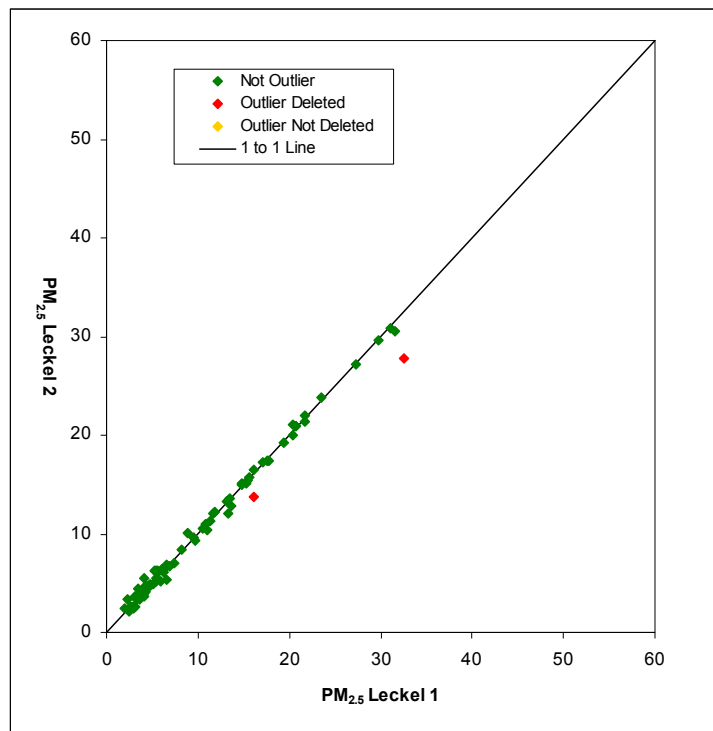

Figure 28: Grubbs test results for PM<sub>2.5</sub> reference method, Teddington (Summer)

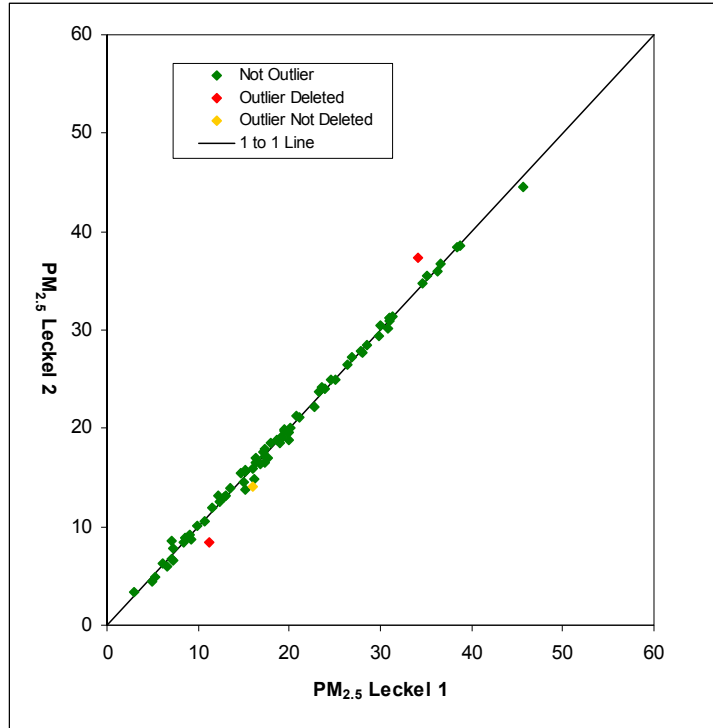

Figure 29: Grubbs test results for PM<sub>2.5</sub> reference method, Cologne (Winter)

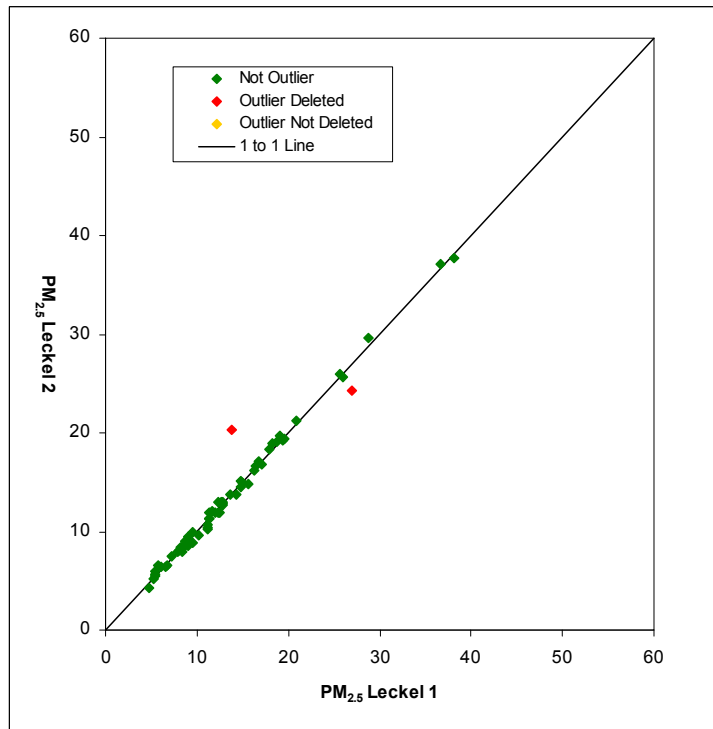

Figure 30: Grubbs test results for PM<sub>2.5</sub> reference method, Bornheim (Summer)

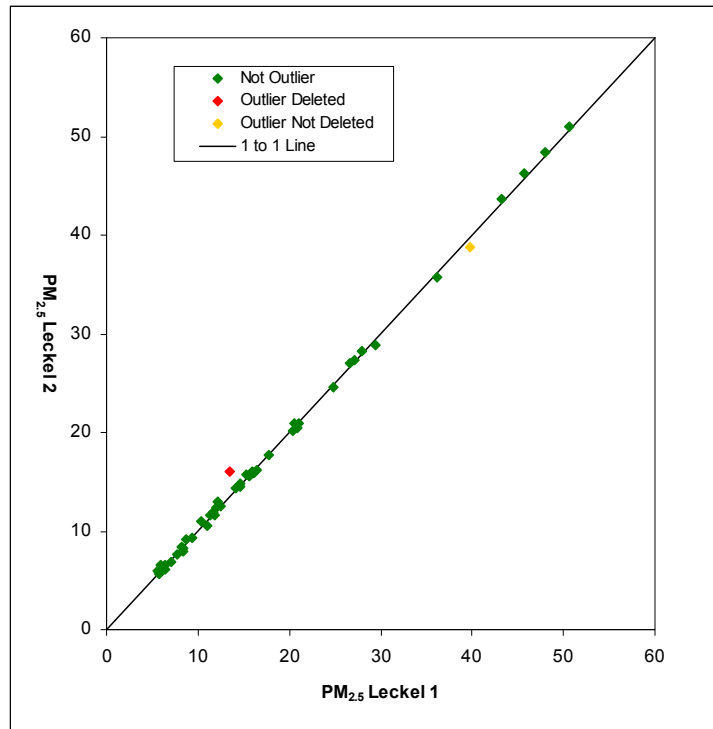

Figure 31: Grubbs test results for PM<sub>2,5</sub> reference method, Teddington (Winter)

### Handling of filters – mass determination

The following filters were used for the suitability test:

Table 7: Used filter material

| Measuring device          | Filter material, Type | Manufacturer |
|---------------------------|-----------------------|--------------|
| Reference devices<br>LVS3 | Emfab™, Ø 47 mm       | Pall         |

The filter material EMFAB™ (teflon-coated glass fibre filters) was used in the scope of the „Combined MCERTS and TÜV PM Equivalence Testing“ program by special request of our British partner, because according to [8], they consider it most appropriate for the test.

The filter handling conforms to the requirements of EN 14907.

The procedures of filter handling and weighing are described in detail in Annex 2 of this report.

## 5 Reference measurement procedures

The following devices were used during the field test in accordance with EN 14907:

### 1. Reference equipment for PM<sub>2.5</sub>:

Small filter device "Low Volume Sampler LVS3"  
Manufacturer: Ingenieurbüro Sven Leckel, Leberstraße 63, Berlin,  
Germany  
Date of manufacture: 2007  
PM<sub>2.5</sub>-Sampling inlet

Two reference devices were simultaneously operated with a controlled volume flow of 2.3 m<sup>3</sup>/h. The accuracy of the volume flow control is below <1 % of the nominal volume flow under standard conditions.

The sampling air is sucked in *via* the rotary vane vacuum pump through the sampling inlet for the small filter device LVS3. The sampling air volume flow is measured with a measuring orifice which is installed between filter and vacuum pump. In order to collect the abrasion of the vanes, the incoming air passes a separator before flowing to the air outlet.

The electronic measuring equipment of the LVS3 small filter device displays the incoming sampling air volume in standard or operating m<sup>3</sup> as soon as the sampling is complete.,

To determine the PM<sub>2.5</sub> concentration, the laboratory performed a gravimetric determination of the amount of suspended particulate matter on the respective filters. The obtained result was then divided through the respective volume of sampling air in operating m<sup>3</sup>.

## 6 Test results

### 6.1 4.1.1 Display for measured values

*The measuring system shall be fitted with a display for measured values.*

### 6.2 Equipment

No additional equipment required.

### 6.3 Carrying out the test

The measuring device was checked on the presence of a display for measured values.

### 6.4 Evaluation

The measuring device comprises a display for measured values. The respective measured concentration value from the last measurement cycle can be indicated on different screens of the users display.

### 6.5 Assessment

The measuring device comprises a display for measured values.

Minimum requirement fulfilled? yes

### 6.6 Detailed representation of test results

Figure 32 shows the user's display with the measured concentration value from the last measurement cycle.

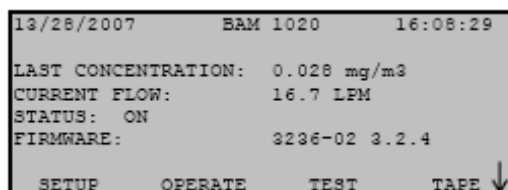

```
13/28/2007      BAM 1020      16:08:29
LAST CONCENTRATION: 0.028 mg/m3
CURRENT FLOW:      16.7 LPM
STATUS: ON
FIRMWARE:          3236-02 3.2.4
  SETUP   OPERATE   TEST   TAPE ↓
```

Figure 32: Display of measured concentration value from the last measurement cycle

## **6.1 4.1.2 Easy maintenance**

*Necessary maintenance for the measuring systems should be possible without larger effort, if possible from outside.*

## **6.2 Equipment**

No additional equipment required.

## **6.3 Carrying out the test**

Necessary regular maintenance works were carried out according to the instructions of the operating manual.

## **6.4 Evaluation**

The following maintenance works should be carried out:

1. Check of device status  
The device status can be monitored and controlled by controlling the system itself or controlling it on-line.
2. In general the sampling inlet shall be cleaned according to the manufacturer's instructions with taking into account the local suspended particulate matter concentrations (during suitability test every 4 weeks).
3. Monthly cleaning of the device. This includes also the cleaning of the nozzle area above the filter tape. In any case, the measuring system has to be cleaned after each measuring activity.
4. Check of the filter tape stock – a 21 m-filter tape is hereby sufficient for approximately 60 days in case of a measurement cycle of 60 min. It is recommended, to check as a matter of routine the filter tape stock at every visit of the measurement site.
5. According to the manufacturer, a flow rate check and a leak check shall be carried out every 4 weeks. Furthermore a plausibility check of the ambient temperature and air pressure measurement is recommended within this context.  
These workings can be done together with the workings according to point 4.
6. Replacement of filter tape after approx. 2 months (measurement cycle: 60 min). After the replacement, it is strongly advised to perform a self-test according to chapter 3.5 of the manual.
7. According to the manufacturer, the calibration of the flow rate should be performed every 2 months.
8. The muffler at the pump should be replaced semiannually.
9. The sensors for the ambient temperature, air pressure, filter temperature and filter rH have to be checked every 6 months according to the manual.
10. The flow controller, the pump and the sample heater have to be checked every 6 months according to the manual.
11. Once a year, a 72 h BKGD-test with the help of the zero filter kit BX-302 according to the manual point 7.7 should be performed
12. Once a year the carbon vanes of the vacuum pump (only rotary vane pump) have to be checked and replaced if necessary during an annual base maintenance.
13. During the annual base maintenance, it is also to pay attention to the cleaning of the sampling tube.

For the performance of the maintenance work, the instructions in the manual have to be respected. All workings can be done with common tools.

It is generally recommended to perform a self-test according to chapter 3.5 of the manual after each action, which interrupts the measurement operation.

## **6.5 Assessment**

Maintenance works can be carried out with customary tools taking reasonable time and effort. The workings according to point 6ff have to be done during shutdown of the system. These workings are only necessary in a two month interval as well as semiannually or annually. During the remaining time, the maintenance can be basically restricted to the check of contaminations, plausibility checks and possible status/error messages.

Minimum requirements fulfilled? yes

## **6.6 Detailed representation of test results**

The maintenance works were carried out during the test in accordance with the instructions given in the manual. No problems were noticed while following the described procedures. All maintenance works could be done with customary tools without taking much time and effort.



## 6.1 4.1.3 Function test

*Particular instruments for function tests shall be considered as part of the device and thus shall be evaluated in the corresponding sub-tests.*

*Test gas units shall indicate readiness by status signals and shall allow direct or remote access to control functions via the measuring system.*

*The measurement uncertainty of the test gas unit shall not exceed 1% of  $B_2$  within three months.*

## 6.2 Equipment

Manual, zero filter kit BX-802, built-in reference foil.

## 6.3 Carrying out the test

To check the zero point of the radiometric measurement, it is resorted to the count rates  $I_1$  respectively  $I_{1x}$ , which are determined on a clean filter tape spot at every measurement cycle (refer to point 3.2 Functionality of the measuring system). The zero point of the radiometric measurement is thereby determined according to the following equation:

$$C_0 [\text{mg}/\text{m}^3] = \frac{A}{Q} * \frac{K}{\mu_2} * \ln\left(\frac{I_1}{I_{1x}}\right)$$

with

|       |                                   |            |  |
|-------|-----------------------------------|------------|--|
| $C_0$ | particle mass concentration at ZP | A          | particle collection area (filter spot) |
| Q     | sampling flow rate                | K, $\mu_2$ | coefficients beta measurement          |
| $I_1$ | initial beta count rate           | $I_{1x}$   | final beta count rate                  |

In order to check the stability of the sensitivity of the radiometric measurement, it is resorted to the count rates  $I_1$  (clean filter spot) respectively  $I_2$  (clean filter spot + retracted reference foil), which are determined at every measurement cycle (refer to point 3.2 Functionality of the measuring system). The mass density  $m$  [ $\text{mg}/\text{cm}^2$ ] of the reference foil is calculated device-internal from the determined count rates. The value is continuously compared to the nominal value ABS, which has been determined in the factory and in case of a deviation of >5% to the nominal value, an error message is generated.

Hence there is the possibility to determine the zero point as well as the reference value (automatically) for each measurement cycle (here: once per hour). The obtained hourly values at zero point and at reference point are offered via the serial interface and are easily available for evaluation with an external spreadsheet. Within the scope of the test, the results of the internal tests have been compressed to suitable mean values and been evaluated (e.g. 24-h-mean for drift investigations).

Furthermore there is also the possibility to check the zero point of the measuring device externally. For this a zero filter (BX-302 Zero Filter Calibration Kit) is installed at the device inlet. The use of this filter allows the provision of particle-free air.

Besides the external zero point check for the measuring device, this procedure is also used for the regular determination of the background value BKGD (offset correction for the concentration values) according to the manual chapter 7.7.

Within the scope of the test work, a determination of the zero point by using the zero filter was also performed approx. every 4 weeks.

## **6.4 Evaluation**

All instrument functions, which are listed in the manual, are available and can be activated. The current status of the system is monitored continuously and is indicated by a series of different status messages (operational, alarm and error status).

The measuring system carries out by default an internal check of the zero point (zero measurement) as well as of the sensitivity (measurement with reference foil) at every measurement cycle. It must be pointed out, that only the mass density can be determined by the application of the reference foil. Therefore a direct comparison with the reference values is not possible. For the purpose of evaluation, the percental changes of the determined mass densities have been calculated.

An external check of the zero point by using the zero filter (BX-302 Zero Filter Calibration Kit) is also possible at any time.

## **6.5 Assessment**

All system functions listed in the manual are available, activatable and functioning. The current system status is continuously monitored and displayed by a set of different status messages (operation, warning and error messages).

The results of the device-internal checks of the zero point and of the radiometric measurement as well as the external zero point checks with zero filter during the field investigations are described in chapter 6.1 5.2.9 Zero drift and in chapter 6.1 5.2.10 Drift of the measured value in this report.

Minimum requirements fulfilled? yes

## **6.6 Detailed description of test results**

Refer to point 6.1 5.2.9 Zero drift  
and 6.1 5.2.10 Drift of the measured value

## **6.1 4.1.4 Setup- and warm-up times**

*The set-up times and warm-up times shall be specified in the instruction manual.*

## **6.2 Equipment**

A clock was required for this test.

## **6.3 Carrying out the test**

The AMS were started up according to the description given by the manufacturer. Necessary setup- and warm-up times were recorded separately.

Necessary constructional works prior to the measurement, such as the set-up of a break-through in the container roof, were not included in this test.

## **6.4 Evaluation**

The setup time comprises the time needed for all necessary works from system installation to start-up.

The measuring system must be protected from weather inconsistencies (e.g. in an outdoor cabinet of the system manufacturer or an acclimated measuring container). Extensive construction work is required in order to lead the sample tube through the roof of a measuring container. A non-stationary application is therefore only assumed together with the belonging peripheral devices.

- Unpacking and installation of the measuring system (in a rack or on a table)
- Connection of the sampling tube + PM<sub>10</sub>-sampling inlet + PM<sub>2.5</sub> SCC
- Installation of the heating system
- Connection of the pump
- Mounting of ambient air sensor + radiation protection shield (nearby the sampling inlet)
- Connection of all connecting and control lines
- Connection of power supply
- Switch-on of the measuring system
- Insertion of the filter tape
- Performance of self-test according to point 3.5 in the manual
- Check of the tightness and of the flow rate
- Optional connection of peripheral recording and control systems (data logger, PC with HyperTerminal) to the respective interfaces

The performance of these actions and therewith the set-up time takes 1 to 2 hours.

The warm-up time contains the time need between the start of operation of the measuring system and the readiness for measurement.

After switching on the system and the successful performed self-test, the measuring system remains in a waiting position until reaching the next hour. When reaching the hour, the next measurement cycle as described in point 3.2 Functionality of the measuring system. The sampling starts according to the set measurement time for the radiometry (during the suitability test 8 min) immediately after the radiometric measurement  $I_0$  (zero value of filter spot for sampling).

If required, possible changes of the basic parameterization of the measuring system can likewise be performed within few minutes by personal, familiar with the devices.

### **6.5 Assessment**

The setup- and warm-up times were determined.

The measuring system can be operated at different measurement sites with manageable effort. The set-up time is approximately 1 to 2 hours and the warm-up time is at maximum the time need of a complete measurement cycle (here: 60 min).

Minimum requirement fulfilled? yes

### **6.6 Detailed representation of test results**

Not required for this test.

## **6.1 4.1.5 Instrument design**

*The instruction manual shall include specifications of the manufacturer regarding the design of the measuring system. The main elements are:*

*Instrument shape (e.g. bench mounting, rack mounting, free mounting)*

*Mounting position (e.g. horizontal or vertical mounting)*

*Safety requirements*

*Dimensions*

*Weight*

*Power consumption*

## **6.2 Equipment**

A measuring device for power consumption measurement and a scale were used for this test.

## **6.3 Carrying out the test**

The installation of the delivered systems was compared with the description given in the manuals. The specified power consumption was continuously tested (24h) under standard operation conditions on three days during field test.

## **6.4 Evaluation**

The measuring system has to be installed in horizontal mounting position, independent from atmospheric conditions. At this, the system should be installed on an even plane (e.g. table). The installation in a 19"rack is also possible.

The dimensions and the weights of the measuring system are in compliance with the specifications in the manual.

The power consumption of the measuring system with the used pump is specified by the manufacturer with at maximum 370 W. During 3 tests, each with 24 h, this specification was checked. At no time the mentioned value was exceeded during these investigations. The mean power consumption during the investigation for a measurement cycle of 60 min (42 min sampling) was approximately 150 W.

## **6.5 Assessment**

The instrument design specifications listed in the operating manual are complete and correct.

Minimum requirement fulfilled? yes

## **6.6 Detailed representation of test results**

Not required for this minimum requirement.

## **6.1 4.1.6 Security**

*The AMS shall have a means of protection against unauthorized access to control functions.*

## **6.2 Equipment**

No additional equipment required.

## **6.3 Carrying out the test**

The operation of the measuring device is carried out via the keypad at the front panel or via the RS232-interfaces and modem from an external computer.

The menu "Setup" is completely protected by a password, except for the sub-point time setting. An alteration of the set parameters without the knowledge of the password is not possible.

An adjustment of the sensors for the ambient temperature, air pressure as well as for the flow rate measurement in the menu „Test/Flow“ as well as of the sensors for the control of the sample heater in the menu „Test/Heater“ is only possible via several key sequences.

It must be pointed out, that the current measurement cycle is interrupted by pressing the keys „Setup“, „Test“ or „Tape“ and the next measurement cycle does not begin until the following next hour.

As an outside installation of the measuring device is not possible, additional protection is given by installation at locations, to which unauthorized people have no access (e.g. locked measurement cabinet).

## **6.4 Evaluation**

Unintended adjustment of instrument parameters is avoided by the pass word protection of the menu "Setup". The adjustment of sensors for the flow rate measurement and for the operation of the sample heater can only be done via several key sequences. Moreover there is an additional protection against unauthorized intervention by the installation in a locked measurement cabinet.

## **6.5 Assessment**

The AMS is protected against unauthorized and unintended adjustment. In addition, the AMS shall be locked in a measuring cabinet.

Minimum requirement fulfilled? yes

## **6.6 Detailed representation of test results**

Not required for this minimum requirement.

## **6.1 4.1.7 Data output**

*The output signals shall be provided digitally (e.g. RS 232) and/or as analogue signals (e.g. 4 mA to 20 mA).*

## **6.2 Equipment**

PC with software „HyperTerminal“, data logger Yokogawa (for analogue signal)

## **6.3 Carrying out the test**

The test was carried out using an electronic data recording system of the type Yokogawa (analogue output, only test in laboratory) and a PC with the software „HyperTerminal“ (digital output, serial interfaces RS 232 #1 & #2).

The data recording systems were connected to the analogue as well as digital output. The test was performed by comparing the measured values from the display, analogue and digital output in the laboratory.

## **6.4 Evaluation**

The measured signals are offered at the rear side of the instrument in the following way:

Analogue: 0-1 resp. 10 V resp. 0-16 mA / 4-20 mA  
concentration range selectable

Digital: via 2xRS 232-interface - via direct or modem connection to a computer, the device can be completely controlled – e.g. it is possible to readout the buffer with all data to past measurements (serial interface #1).

The determined measured values have been output analogue as well as digital in compliance with the indicated value in the instrument buffer.

## **6.5 Assessment**

Measured signals are offered analogue (0-1 resp. 10 V resp. 0-16 mA / 4-20 mA) and digital (via RS 232).

The connection of additional measuring and peripheral devices to the respective ports of the devices is possible.

Minimum requirement fulfilled? yes

## 6.6 Detailed representation of test results

Figure 33 shows a view of the rear side of the instrument with the respective measured value outputs.



Figure 33: View on rear of the device BAM-1020



## **6.1 4.2 Requirements for mobile measuring systems**

*Measuring systems for mobile application shall also comply with the requirements on measuring systems for stationary application in the case of mobile application. The measuring system shall be in a permanent operational stand-by mode during mobile application, e.g. measurements in running traffic, time-limited measurements at different site or measurements on aircraft.*

### **6.2 Equipment**

No additional equipment required.

### **6.3 Carrying out the test**

Within the scope of the field test, the measuring system was tested at several field test sites.

### **6.4 Evaluation**

The measuring systems have been designed for fixed installation in a measurement station / a measurement cabinet. A mobile application is only possible together with a measurement cabinet.

The permanent operational stand-by for time-limited measurements at different sites is ensured when considering the conditions of mounting (choice of measurement site, infrastructure).

For a mobile application, the set-up and warm-up times have to be considered beside the mounting conditions.

### **6.5 Assessment**

In the context of the field test, the measuring system was operated at several different sites, but cannot be operated in moving vehicles.

Minimum requirements fulfilled? no

### **6.6 Detailed representation of test results**

Not required for this minimum requirement.

## **6.1 5.1 General**

*The manufacturer's specifications shall not be contrary to the results of the suitability test.*

## **6.2 Equipment**

No additional equipment required.

## **6.3 Carrying out the test**

The test results are compared with the specifications given in the manual.

## **6.4 Evaluation**

Found deviations between the first draft of the manual and the actual design were resolved.

## **6.5 Assessment**

Differences between the instrument design and the descriptions given in the manual could not be detected.

Minimum requirement fulfilled? yes

## **6.6 Detailed representation of test results**

Refer to point 6.4 of this module.

## **6.1 5.2.1 Measuring range**

*The upper limit of measurement range of the measuring systems shall be greater or equal to reference value  $B_2$ .*

## **6.2 Equipment**

No additional equipment required.

## **6.3 Carrying out the test**

It was tested, whether the upper limit of measuring range of the measuring system is greater or equal to the reference value  $B_2$

## **6.4 Evaluation**

The following measuring ranges can be set at the measuring system:  
0 – 0.100, 0 – 0.200, 0 – 0.250, 0 – 0.500, 0 – 1.000, 0 – 2.000, 0 – 5.000 as well as  
0 – 10.000 mg/m<sup>3</sup>.

During the suitability test, the measuring range has been set to 0 – 1.000 mg/m<sup>3</sup> =  
0 – 1,000 µg/m<sup>3</sup>.

Measuring range: 0 – 1.000 µg/m<sup>3</sup> (standard)

Reference value: VDI:  $B_2 = 200 \mu\text{g}/\text{m}^3$ .

## **6.5 Assessment**

A measuring range of 0 to 1,000 µg/m<sup>3</sup> is set by default. Other measuring ranges in the range between at minimum 0-100 µg/m<sup>3</sup> and at maximum 0-10,000 µg/m<sup>3</sup> are possible.

The upper limit of measuring range of the measuring system is greater than the reference value  $B_2$ .

Minimum requirement fulfilled? yes

## **6.6 Detailed representation of test results**

Not required for this minimum requirement.

## **6.1 5.2.2 Negative output signals**

*Negative output signals or measured values may not be suppressed (live zero).*

## **6.2 Equipment**

No additional equipment required.

## **6.3 Carrying out the test**

The AMS was tested on its ability to display negative output signals in the laboratory and in the field.

## **6.4 Evaluation**

The measuring system can output negative values via the display as well as via the analogue and digital outputs.

## **6.5 Assessment**

Negative measuring signals are displayed directly and are output correctly via the respective measured value outputs by the measuring system.

Minimum requirement fulfilled? yes

## **6.6 Detailed representation of test results**

Not required for this minimum requirement.

## **6.1 5.2.3 Analytical function**

*The relationship between the output signal and the value of the air quality characteristic shall be represented by the analytical function and determined by regression analysis.*

## **6.2 Equipment**

Refer to point 7.1 Calculation of the expanded uncertainty of the instruments [9.5.2.2-9.5.6]

## **6.3 Carrying out the test**

For dust measuring devices for PM<sub>2.5</sub> measurements, the test should be carried out according to point 7.1 Calculation of the expanded uncertainty of the instruments [9.5.2.2-9.5.6].

## **6.4 Evaluation**

The comparability of the measuring devices according to point 7.1 Calculation of the expanded uncertainty of the instruments [9.5.2.2-9.5.6] was proved within the framework of the test.

The entire data record (251 valide data pairs for SN 17010 and 253 valid data pairs for SN 17011) is used for determining the calibration or analytical function.

The characteristic data of the calibration function

$$y = m * x + b$$

were determined by orthogonal regression. The analytical function is the reversed calibration function and described as follows:

$$x = 1/m * y - b/m$$

The slope m of the regression line characterizes the sensitivity of the measuring device; the ordinate intercept b characterizes zero point.

This results in the characteristic data presented in Table 8.

*Table 8: Results of the calibration and analytical function*

| Device No. | Calibration function                              |                          | Analytical function                               |                          |
|------------|---|--------------------------|---|--------------------------|
|            | $Y = m * x + b$                                   |                          | $x = 1/m * y - b/m$                               |                          |
|            | m   | B                        | 1/m   | b/m                      |
|            | $\mu\text{g}/\text{m}^3 / \mu\text{g}/\text{m}^3$ | $\mu\text{g}/\text{m}^3$ | $\mu\text{g}/\text{m}^3 / \mu\text{g}/\text{m}^3$ | $\mu\text{g}/\text{m}^3$ |
| SN 17010   | 0.969   | 0.989                    | 1.032   | 1.021                    |
| SN 17011   | 1.041   | 0.377                    | 0.961   | 0.362                    |

## 6.5 Assessment

A statistically secured correlation could be proved between the reference method and the instrument reading.

The candidates fulfil the criteria of the equivalence test according to chapter 7 of this report without the application of the determined analytical function with the as factory settings implemented calibration factors in the devices

Minimum requirement fulfilled? yes

## 6.6 Detailed representation of test results

Refer to chapter 7.1 Calculation of the expanded uncertainty of the instruments [9.5.2.2-9.5.6].

## **6.1 5.2.4 Linearity**

*Reliable linearity is given, if deviations of the group averages of measured values about the calibration function are smaller than 5 % of  $B_1$  in the range of zero to  $B_1$ , and smaller than 1 % of  $B_2$  in the range of zero to  $B_2$ .*

## **6.2 Equipment**

Refer to module 5.3.1)

## **6.3 Carrying out the test**

The test should be carried out according to minimum requirement 5.3.1 „Equivalency of the sampling system“ for particle measuring devices.

## **6.4 Evaluation**

Refer to module 5.3.1.

## **6.5 Assessment**

The test should be carried out according to minimum requirement 5.3.1 „Equivalency of the sampling system“ for particle measuring devices.

Refer to module 5.3.1.

Minimum requirement fulfilled? yes

## **6.6 Detailed representation of test results**

Refer to module 5.3.1.

## 6.1 5.2.5 Detection limit

*The detection limit of the measuring system shall be smaller or equal to reference value  $B_0$ . The detection limit shall be determined in the field.*

## 6.2 Equipment

BX-302 zero filter kit for zero point check.

## 6.3 Carrying out the test

The determination was carried out for the devices no. SN 17010 and SN 17011 with the help of zero filters which were installed to the inlet of each measuring device. The offering of particle-free air were done over 15 days of continuous measurement (24h periods). The detection limits were determined during the laboratory tests since a particle-free air supply over a long period was not possible under field conditions.

## 6.4 Evaluation

The detection limit  $X$  is determined from standard deviation  $s_{x_0}$  of the measured values for both measuring devices and particle-free sampling air. It corresponds to the standard deviation of the average value  $\bar{x}_0$  of the measured values  $x_{0i}$  multiplied with the student factor.

$$X = t_{n-1;0,95} \cdot s_{x_0} \quad \text{with} \cdot s_{x_0} = \sqrt{\frac{1}{n-1} \cdot \sum_{i=1,n} (x_{0i} - \bar{x}_0)^2}$$

Reference value:  $B_0 = 2 \mu\text{g}/\text{m}^3$

## 6.5 Assessment

The detection limit has been determined from the investigations to  $1.33 \mu\text{g}/\text{m}^3$  for device 1 (SN 17010) and to  $1.09 \mu\text{g}/\text{m}^3$  for device 2 (SN 17011).

Minimum requirement fulfilled? yes



## 6.6 Detailed representation of test results

Table 9: *Detection limit*

|                                    |                          | Device SN 17010 | Device SN 17011 |
|------------------------------------|--------------------------|-----------------|-----------------|
| No. of values n                    |                          | 15              | 15              |
| Average of zero values $\bar{x}_0$ | $\mu\text{g}/\text{m}^3$ | -0.55           | -1.09           |
| Standard deviation $s_{x_0}$       | $\mu\text{g}/\text{m}^3$ | 0.62            | 0.51            |
| Student factor $t_{n-1;0,95}$      |                          | 2.14            | 2.14            |
| Detection limit X                  | $\mu\text{g}/\text{m}^3$ | <b>1.33</b>     | <b>1.09</b>     |

The single values for the determination of the detection limit can be found in annex 1 in the appendix.

## **6.1 5.2.6 Response time**

*The response time (90%-time) of the measuring system shall be smaller or equal to 5 % of the averaging time (180 s).*

According to Standard VDI Sheet 3, point 5.3, this test point is not relevant for particulate measuring systems with pre-separation, based on a physical measurement method.

## **6.2 Equipment**

Not applicable.

## **6.3 Carrying out the test**

Not applicable.

## **6.4 Evaluation**

Not applicable.

## **6.5 Assessment**

Not applicable.

Minimum requirement fulfilled? -

## **6.6 Detailed representation of test results**

Not applicable.

## **6.1 5.2.7 Ambient temperature dependency of zero point**

*The temperature dependency of the measured value at zero concentration shall not exceed the reference value  $B_0$  if ambient temperature is changed by 15 K in the range of +5 °C to +20 °C or by 20 K in the range of +20 °C to +40 °C.*

## **6.2 Equipment**

Climate chamber adjusted to a temperature range of +5 °C to +40 °C, zero filter kit BX-302 for zero point check.

## **6.3 Carrying out the test**

The complete measuring systems were operated in a climate chamber in order to evaluate the dependency of zero point on ambient temperature. Both candidates SN 17010 and SN 17011 were supplied with particle-free sampling air by installing a zero filter at the device inlet. The ambient temperatures in the climate chamber were varied according to the following sequence 20 °C – 5 °C – 20 °C – 40 °C – 20 °C. The measured values at zero point were recorded ( 3 times per temperature step) after an equilibration time of approximately 24 h per temperature step. Relative humidity was kept constant.

## **6.4 Evaluation**

The measured values for the concentration of the individual 24h-measurements were read out and evaluated. The absolute deviation in  $\mu\text{g}/\text{m}^3$  per temperature step, related to the start point of 20 °C, was considered.

Reference value:  $B_0 = 2 \mu\text{g}/\text{m}^3$ .

## **6.5 Assessment**

Considering the values offered from the device, a maximum influence of the ambient temperature on the zero point of  $-1.6 \mu\text{g}/\text{m}^3$  could be detected.

$-1.20 \mu\text{g}/\text{m}^3$  were used for SN 17010 and  $-1.60 \mu\text{g}/\text{m}^3$  for SN 17011 to calculate uncertainty according to point 6.1 5.2.21 Total uncertainty.

Minimum requirement fulfilled? yes

## 6.6 Detailed representation of test results

*Table 10: Ambient temperature dependency of zero point, deviation in  $\mu\text{g}/\text{m}^3$ , average of three measurements*

| Temperature        |                    | Deviation                |                          |
|--------------------|--------------------|--------------------------|--------------------------|
| Start temperature  | End temperature    | Device 1<br>(SN 17010)   | Device 2<br>(SN 17011)   |
| $^{\circ}\text{C}$ | $^{\circ}\text{C}$ | $\mu\text{g}/\text{m}^3$ | $\mu\text{g}/\text{m}^3$ |
| 20                 | 5                  | 0.3                      | 1.0                      |
| 5                  | 20                 | -1.2                     | 0.4                      |
| 20                 | 40                 | -1.0                     | -1.6                     |
| 40                 | 20                 | 0.6                      | 0.2                      |

The results of the three individual measurements are presented in Annex 2 of the appendix.

## **6.1 5.2.8 Ambient temperature dependency of the measured value**

*The temperature dependency of the measured value in the range of reference value  $B_1$  shall not exceed 5 % of the measured value if ambient temperature is changed by 15 K in the range of +5 °C to +20 °C or by 20 K in the range of +20 °C to +40 °C.*

## **6.2 Equipment**

Climate chamber adjusted to a temperature range of +5 °C to +40 °C, built-in reference foils

## **6.3 Carrying out the test**

For the investigation of the dependence of the measured values on the ambient temperature, the complete measuring systems have been operated in the climate chamber. To check the stability of the sensitivity of the radiometric measurement for the candidates SN 17010 and SN 17011, it is resorted to the count rates  $I_1$  (clean filter spot) respectively  $I_2$  (clean filter spot + retracted reference foil), which are determined at every measurement cycle (refer to point 3.2 Functionality of the measuring system). The mass density  $m$  [ $\mu\text{g}/\text{cm}^2$ ] of the reference foil is calculated device-internal from the determined count rates.

The ambient temperatures in the climate chamber were varied in triple repetition in the order 20 °C – 5 °C – 20 °C – 40 °C – 20 °C. After a respective time for equilibration of approximately 6 h per temperature step, the measured values at the reference point have been recorded. The relative humidity was kept constant .

## **6.4 Evaluation**

The percental changing of the determined mass density value (built-in reference foil) for each temperature step, related to the start point of 20 °C, has been considered.

As remark it should be mentioned, that only mass densities and no concentration values can be simulated by the application of the built-in reference foil, a consideration in the range of  $B_1$  (= 25  $\mu\text{g}/\text{m}^3$ ) was not possible because of this reason.

## **6.5 Assessment**

No deviations higher than > -0.2 % were determined for device 1 (SN 17010). For device 2 (SN 17011) deviations did not exceed 0.3 % of the initial value at 20 °C.

0.05  $\mu\text{g}/\text{m}^3$  (= -0.2 % of 25  $\mu\text{g}/\text{m}^3$ ) were used for SN 17010 and 0.08  $\mu\text{g}/\text{m}^3$  (= 0.3 % of 25  $\mu\text{g}/\text{m}^3$ ) for SN 17011 to calculate uncertainty according to point 6.1 5.2.21 Total uncertainty.

Minimum requirement fulfilled? yes

## 6.6 Detailed representation of test results

*Table 11: Ambient temperature dependency of sensitivity SN 17010 & SN 17011, deviation in %, average of three measurements*

| Temperature             |                       | Deviation                    |                              |
|-------------------------|-----------------------|------------------------------|------------------------------|
|                         |                       | Device 1 (SN 17010)          | Device 2 (SN 17011)          |
| Start temperature<br>°C | End temperature<br>°C | built-in reference foil<br>% | built-in reference foil<br>% |
| 20                      | 5                     | 0.0                          | 0.0                          |
| 5                       | 20                    | 0.0                          | 0.1                          |
| 20                      | 40                    | 0.2                          | 0.3                          |
| 40                      | 20                    | 0.0                          | 0.0                          |

The results of the three individual measurements are presented in annex 2 of the appendix.

## **6.1 5.2.9 Zero drift**

*The temporal change in the measured value at zero concentration shall not exceed the reference value  $B_0$  in 24 h and in the maintenance interval.*

## **6.2 Equipment**

Zero-filter kit BX-302

## **6.3 Carrying out the test**

The test was carried out in the context of the field test over a time period of approximately 20 months in total.

For this reason the measuring devices were operated with zero-filter at the inlet approx. once a month (incl. at the beginning and at the end of each test site) for a time period of at least 24 h and the measured zero values were evaluated.

The daily zero point check, required in the test plan, is on principle possible for this particulate measuring system by evaluating the device-internal check of the zero point of the radio-metric measurement. Hereby the count rates  $I_1$  respectively  $I_{1x}$ , which are determined on a clean filter tape spot at every measurement cycle (refer to point 3.2 Functionality of the measuring system) are evaluated. Within the scope of the test, a daily evaluation of the full dataset has been renounced due to reasons of practicability (large amount of data). However as an example a graphic presentation of the results for the candidate SN 17011 at test site Cologne (Winter) has been carried out in Figure 36 and in Figure 37.

The evaluation of the internal zero point measurement leads to no interruption of the ongoing measuring operation at all.

## **6.4 Evaluation**

The evaluation is based on the measured values obtained with the regular external as well as internal zero point measurements by comparison of the respective values to those of the previous and to those of the first test.

## **6.5 Assessment**

The detected values are all within the allowed limits of  $B_0 = 2 \mu\text{g}/\text{m}^3$  during the maintenance interval.

Minimum requirement fulfilled? yes

$1.8 \mu\text{g}/\text{m}^3$  were used for SN 17010 and  $1.6 \mu\text{g}/\text{m}^3$  for SN 17011 to calculate uncertainty according to point 6.1 5.2.21 Total uncertainty.

## 6.6 Detailed representation of test results

Table 12 and Table 13 contain the determined measured values for the zero point and the calculated deviations related to the previous value and related to the start value in  $\mu\text{g}/\text{m}^3$ .  
Figure 34 and Figure 35 show a graphic interpretation of the zero point drift over the time period of testing.

Table 12: Zero point drift SN 17010, with zero filter

| Date                  | Measured value           | Deviation to previous value | Deviation to start value |
|-----------------------|--------------------------|-----------------------------|--------------------------|
|                       | $\mu\text{g}/\text{m}^3$ | $\mu\text{g}/\text{m}^3$    | $\mu\text{g}/\text{m}^3$ |
| 07/24/2008            | 1.4                      | -                           | -                        |
| 08/18/2008            | -0.8                     | -2.2                        | -2.2                     |
| 09/23/2008            | 1.0                      | 1.7                         | -0.4                     |
| 10/16/2008            | 1.8                      | 0.8                         | 0.3                      |
| 11/10/2008            | -0.1                     | -1.8                        | -1.5                     |
| 12/03/2008            | -1.2                     | -1.2                        | -2.7                     |
| 01/07/2009            | 0.4                      | 1.6                         | -1.0                     |
| 02/02/2009            | -0.7                     | -1.1                        | -2.1                     |
| 03/04/2009            | -1.5                     | -0.8                        | -2.9                     |
| 04/02/2009            | 0.2                      | 1.7                         | -1.2                     |
| 08/13 &<br>08/14/2009 | 0.1                      | -0.1                        | -1.3                     |
| 09.14.2009            | -0.1                     | -0.2                        | -1.5                     |
| 10.23.2009            | -0.1                     | 0.0                         | -1.5                     |
| 12.07.2009            | 0.9                      | 1.0                         | -0.5                     |
| 01.04.2010            | 0.4                      | -0.5                        | -1.0                     |
| 02.05.2010            | -0.3                     | -0.7                        | -1.7                     |



*Table 13: Zero point drift SN 17011, with zero filter*

| Date                  | Measured value           | Deviation to previous value | Deviation to start value |
|-----------------------|--------------------------|-----------------------------|--------------------------|
|                       | $\mu\text{g}/\text{m}^3$ | $\mu\text{g}/\text{m}^3$    | $\mu\text{g}/\text{m}^3$ |
| 07/24/2008            | -1.3                     | -                           | -                        |
| 08/18/2008            | -1.1                     | 0.2                         | 0.2                      |
| 09/23/2008            | -0.6                     | 0.4                         | 0.6                      |
| 10/16/2008            | -0.8                     | -0.1                        | 0.5                      |
| 11/10/2008            | -0.2                     | 0.6                         | 1.1                      |
| 12/03/2008            | -0.3                     | -0.1                        | 1.0                      |
| 01/07/2009            | 0.7                      | 0.9                         | 1.9                      |
| 02/02/2009            | -0.4                     | -1.1                        | 0.8                      |
| 03/04/2009            | -1.1                     | -0.7                        | 0.2                      |
| 04/02/2009            | 0.4                      | 1.5                         | 1.6                      |
| 08/13 &<br>08/14/2009 | -1.3                     | -1.6                        | 0.0                      |
| 09.14.2009            | 0.3                      | 1.6                         | 1.6                      |
| 10.23.2009            | -0.2                     | -0.6                        | 1.0                      |
| 12.07.2009            | 0.5                      | 0.8                         | 1.8                      |
| 01.04.2010            | 0.8                      | 0.3                         | 2.1                      |
| 02.05.2010            | 1.6                      | 0.8                         | 2.9                      |

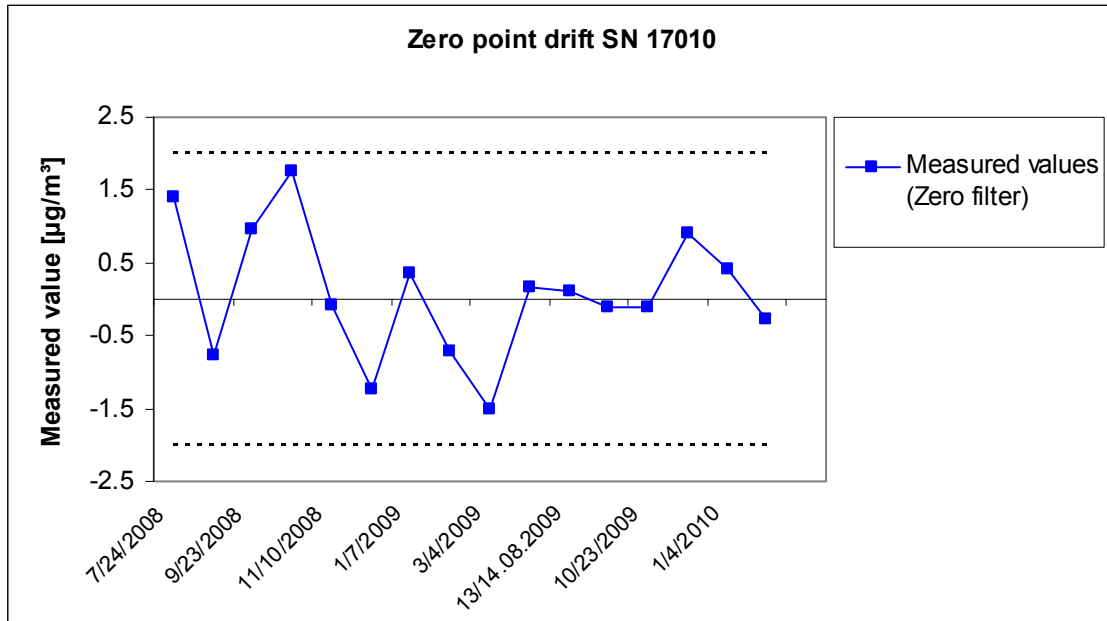

Figure 34: Zero point drift SN 17010

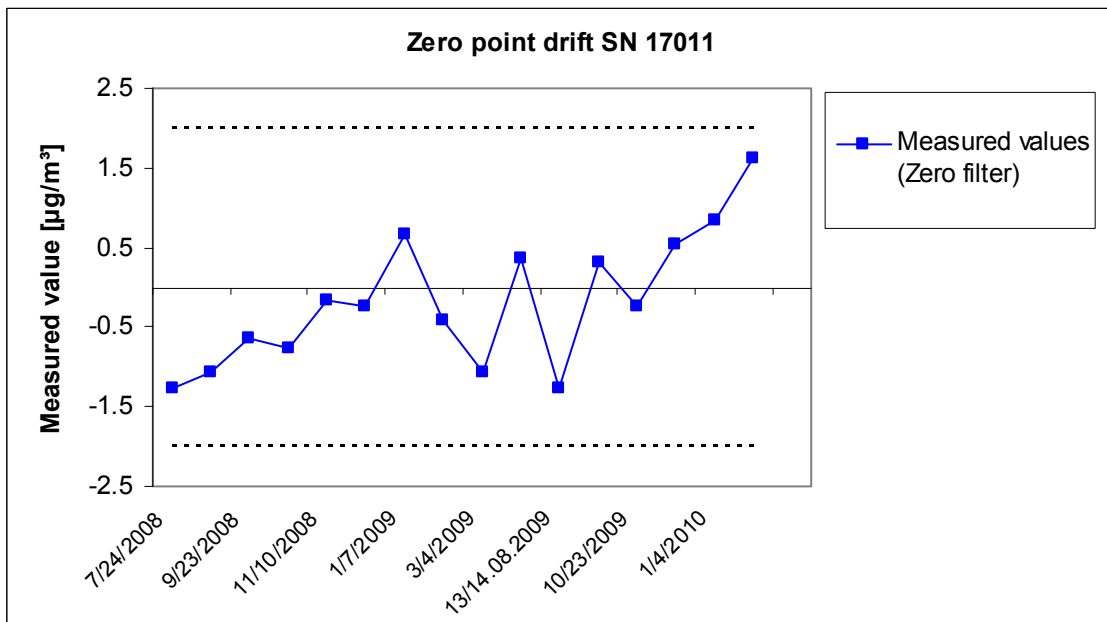

Figure 35: Nullpunktdrift SN 17011

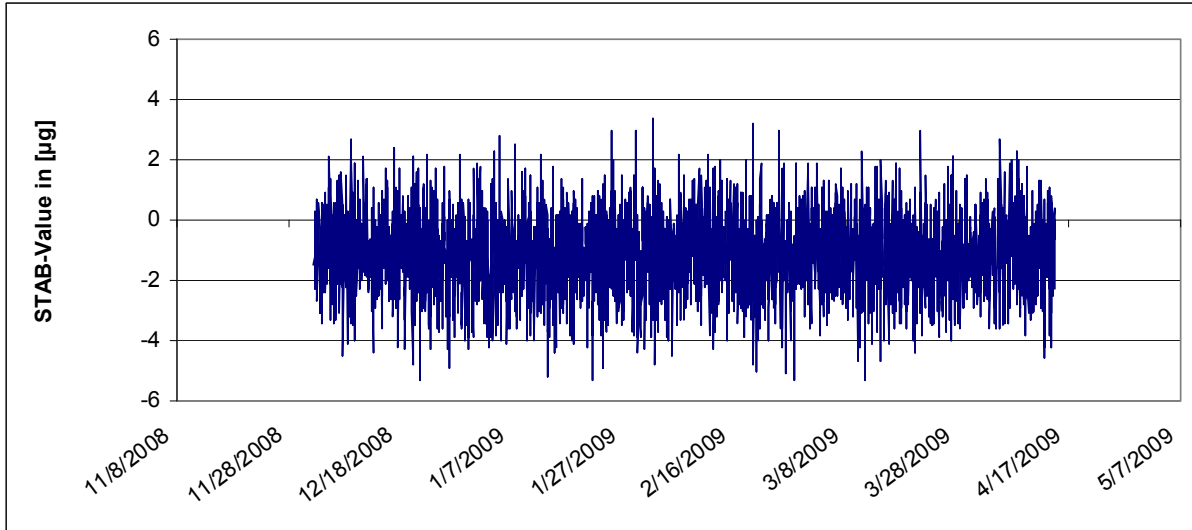

Figure 36: Internal zero point check, SN 17011, Cologne (Winter), Measured values for stability from each cycle (1 x per hour)

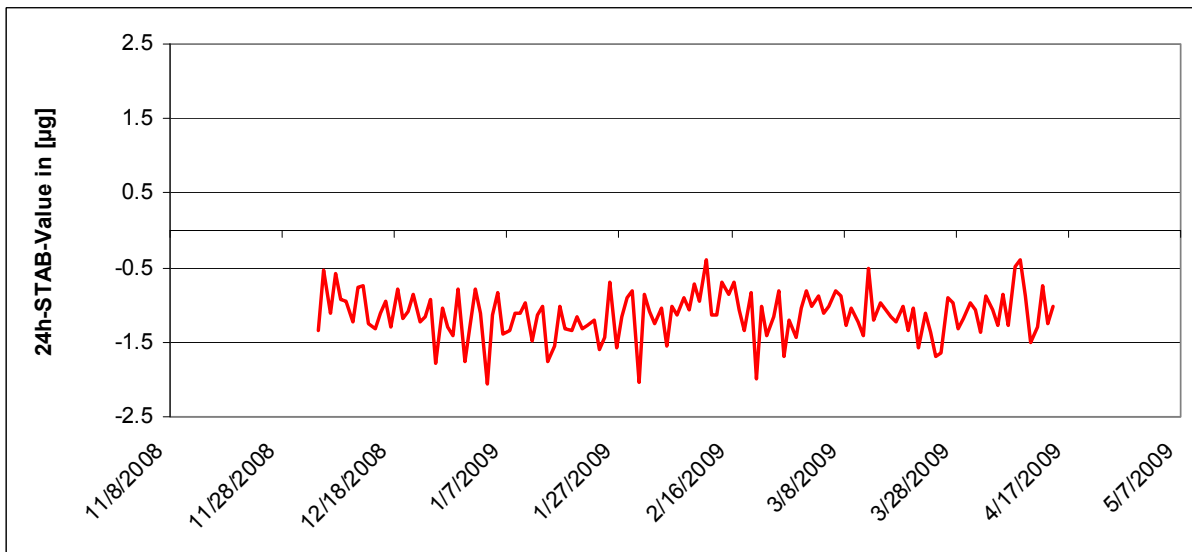

Figure 37: Internal zero point check, SN 17011, Cologne (Winter), 24h-mean values of measured values for stability from each cycle

## 6.1 5.2.10 Drift of the measured value

*The temporal change in the measured value in the range of reference value  $B_1$  shall not exceed 5 % of  $B_1$  in 24 h and in the maintenance interval.*

## 6.2 Equipment

Built-in reference foil.

## 6.3 Carrying out the test

The test has been performed within the scope of the field test over a time period of approximately 20 months in total.

The daily reference point check, required in the test plan, is on principle possible for this particulate measuring system by evaluating the device-internal check of the stability of the sensitivity of the radiometric measurement. Hereby it is resorted to the count rates  $I_1$  (clean filter spot) respectively  $I_2$  (clean filter spot + retracted reference foil), which are determined at every measurement cycle (refer to point 3.2 Functionality of the measuring system). The mass density  $m$  [ $\mu\text{g}/\text{cm}^2$ ] of the reference foil is calculated device-internal from the determined count rates.

Within the scope of the test, a daily evaluation of the full dataset has been renounced due to reasons of practicability (large amount of data). However an exemplary evaluation and graphic presentation of the results for the time periods during which the devices were in parallel operated with zero filters has been carried out (approx. 1 x per month).

The evaluation of the internal reference point measurement leads to no interruption of the ongoing measuring operation at all.

## 6.4 Evaluation

The evaluation is based on the measured results of the internal reference point check by comparison of the respective values to those of the previous and to those of the first test

As remark it should be mentioned, that only mass densities and no concentration values can be simulated by the application of the built-in reference foil, a consideration in the range of  $B_1$  ( $= 25 \mu\text{g}/\text{m}^3$ ) was not possible because of this reason.

## 6.5 Assessment

The measuring system carries out a regular device-internal check of the sensitivity of the radiometric measurement during each measurement cycle. This test leads to no interruption of the ongoing measuring operation at all. The values for the drift of the sensitivity, determined within the scope of the test, were at maximum 0.5 % (SN 17010) respectively -0.5 % (SN 17011) in the maintenance interval.

$0.13 \mu\text{g}/\text{m}^3$  ( $=0.5 \%$  of  $25 \mu\text{g}/\text{m}^3$ ) were used for SN 17010 and  $-0.13 \mu\text{g}/\text{m}^3$  ( $=-0.5 \%$  of  $25 \mu\text{g}/\text{m}^3$ ) for SN 17011 to calculate uncertainty according to point 6.1 5.2.21 Total uncertainty.

Minimum requirement fulfilled? yes

## 6.6 Detailed representation of test results

Table 14 and Table 15 show the determined values in % of the respective previous value and the initial value. Figure 38 and Figure 39 show a graphical representation of the drift of the measured value (related to the previous value).

Table 14: *Drift of the measured value SN 17010*

| Date                  | Measured value            | Deviation to previous value | Deviation to start value |
|-----------------------|---------------------------|-----------------------------|--------------------------|
|                       | $\mu\text{g}/\text{cm}^2$ | %                           | %                        |
| 07/24/2008            | 830.2                     | -                           | -                        |
| 08/18/2008            | 828.6                     | -0.2                        | -0.2                     |
| 09/23/2008            | 829.3                     | 0.1                         | -0.1                     |
| 10/16/2008            | 829.1                     | 0.0                         | -0.1                     |
| 11/10/2008            | 828.5                     | -0.1                        | -0.2                     |
| 12/03/2008            | 829.7                     | 0.1                         | 0.0                      |
| 01/07/2009            | 830.2                     | 0.1                         | 0.0                      |
| 02/02/2009            | 828.5                     | -0.2                        | -0.2                     |
| 03/04/2009            | 828.1                     | 0.0                         | -0.2                     |
| 04/02/2009            | 828.8                     | 0.1                         | -0.2                     |
| 08/13 &<br>08/14/2009 | 833.2                     | 0.5                         | 0.4                      |
| 09.14.2009            | 833.7                     | 0.1                         | 0.4                      |
| 10.23.2009            | 833.7                     | 0.0                         | 0.4                      |
| 12.07.2009            | 833.9                     | 0.0                         | 0.4                      |
| 01.04.2010            | 832.6                     | -0.2                        | 0.3                      |
| 02.05.2010            | 833.4                     | 0.1                         | 0.4                      |

Table 15: Drift of the measured value SN 17011

| Date                  | Measured value     | Deviation to previous value | Deviation to start value |
|-----------------------|--------------------|-----------------------------|--------------------------|
|                       | µg/cm <sup>2</sup> | %                           | %                        |
| 07/24/2008            | 824.4              | -                           | -                        |
| 08/18/2008            | 826.4              | 0.2                         | 0.2                      |
| 09/23/2008            | 822.3              | -0.5                        | -0.3                     |
| 10/16/2008            | 822.1              | 0.0                         | -0.3                     |
| 11/10/2008            | 822.3              | 0.0                         | -0.3                     |
| 12/03/2008            | 822.2              | 0.0                         | -0.3                     |
| 01/07/2009            | 823.2              | 0.1                         | -0.1                     |
| 02/02/2009            | 822.1              | -0.1                        | -0.3                     |
| 03/04/2009            | 822.2              | 0.0                         | -0.3                     |
| 04/02/2009            | 822.3              | 0.0                         | -0.3                     |
| 08/13 &<br>08/14/2009 | 825.6              | 0.4                         | 0.1                      |
| 09.14.2009            | 829.4              | 0.5                         | 0.6                      |
| 10.23.2009            | 829.8              | 0.0                         | 0.6                      |
| 12.07.2009            | 828.7              | -0.1                        | 0.5                      |
| 01.04.2010            | 828.8              | 0.0                         | 0.5                      |
| 02.05.2010            | 828.7              | 0.0                         | 0.5                      |

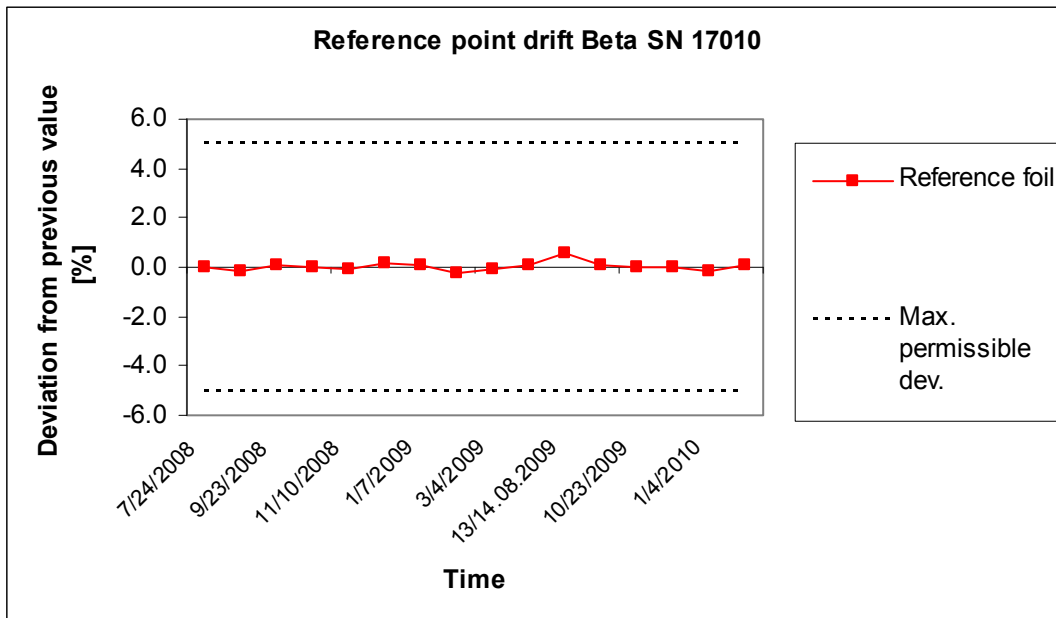

Figure 38: Drift of the measured value SN 17010

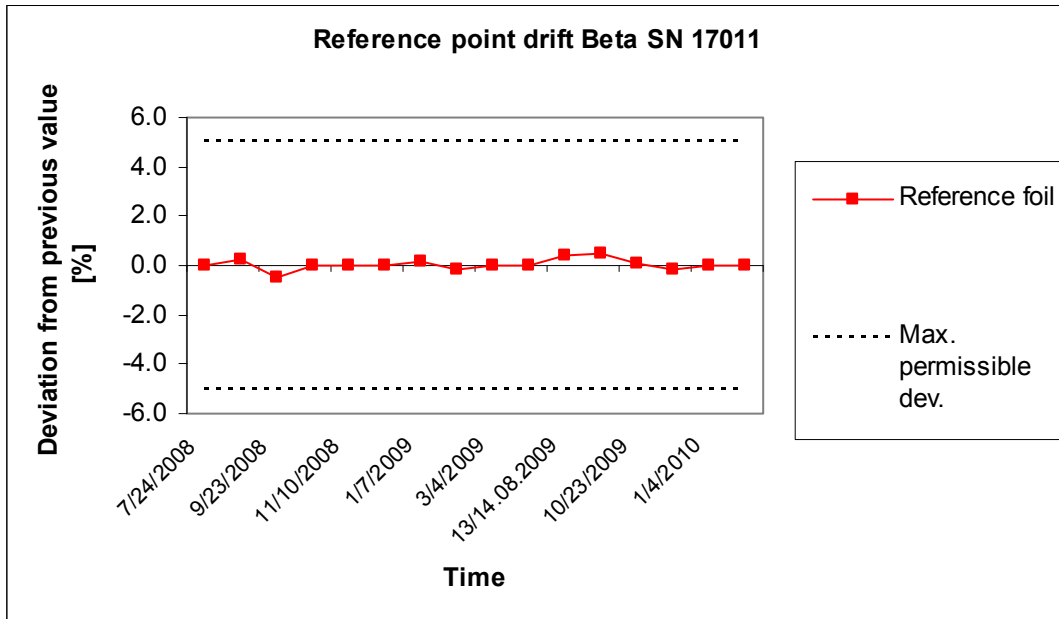

Figure 39: Drift of the measured value SN 17011

## 6.1 5.2.11 Cross sensitivity

*The absolute values of the sum of the positive and the sum of negative deviations caused by cross-sensitivities of interfering components in the measured sample shall not exceed  $B_0$  at the zero point and shall not exceed 3 % of  $B_2$  in the range of  $B_2$ . The concentration of interfering components shall correspond to the  $B_2$  value of the respective interfering component. If reference values have not been specified, the test institute shall specify and declare suitable reference values in agreement with other test institutes.*

This test point is not relevant for particulate measuring systems. Instead, minimum requirement 5.3.4. is essential. For this reason, the results of this test are presented in module 5.3.4.

## 6.2 Equipment

Not applicable.

## 6.3 Carrying out the test

Not applicable.

## 6.4 Evaluation

Not applicable.

## 6.5 Assessment

Not applicable.

Minimum requirement fulfilled? -

## 6.6 Detailed representation of test results

Not applicable.



## 6.1 5.2.12 Reproducibility $R_D$

*The reproducibility  $R_D$  of the measuring system shall be determined by parallel measurements with two identical measuring systems and shall be at least equal to 10.  $B_1$  shall be used as the reference value.*

## 6.2 Equipment

The measuring devices described in chapter 5 were additionally used for this test.

## 6.3 Carrying out the test

Reproducibility  $R_D$  is defined as the maximum deviation of two randomly chosen single values which were obtained under equal conditions in relation to each other. This test has been carried out with two identical devices which were simultaneously operated during the field test. The measured data of the entire field testing was consulted for this test.

## 6.4 Evaluation

Reproducibility  $R_D$  is calculated as follows:

$$R_D = \frac{B_1}{U} \geq 10 \quad \text{where} \quad U = \pm s_D \cdot t_{(n,0,95)} \quad \text{and} \quad s_D = \sqrt{\frac{1}{2n} \cdot \sum_{i=1}^n (x_{1i} - x_{2i})^2}$$

- $R_D$  = Reproducibility  $R_D$  at  $B_1$
- $U$  = Uncertainty
- $B_1$  = 25  $\mu\text{g}/\text{m}^3$
- $s_D$  = Standard deviation from parallel measurements
- $n$  = No. of parallel measurements
- $t_{(n,0,95)}$  = Student factor for 95 % certainty
- $x_{1i}$  = Measured signal of device 1 (e.g. SN 17010) at  $i^{\text{th}}$  concentration
- $x_{2i}$  = Measured signal of device 2 (e.g. SN 17011) at  $i^{\text{th}}$  concentration

## 6.5 Assessment

Reproducibility  $R_D$  in the field was 10 for the complete data set.

Minimum requirement fulfilled? yes

A value of 10 (all test sites) was used to calculate uncertainty according to point 6.1

5.2.21 Total uncertainty.

## 6.6 Detailed representation of test results

Table 16 summarizes the results of the test. Figure 44 to Figure 50 show a graphical representation of the test results.

Note: The determined uncertainties of each site are related to the reference value  $B_1$ .

Table 16: Concentration averages, standard deviation, uncertainty range and reproducibility  $R_D$  in the field, measured component  $PM_{10}$

| Site                   | No. | $\bar{c}$<br>(SN<br>17010) | $\bar{c}$<br>(SN<br>17011) | $\bar{c}_{ges}$          | $s_D$                    | t     | U                        | $R_D$ |
|------------------------|-----|----------------------------|----------------------------|--------------------------|--------------------------|-------|--------------------------|-------|
|                        |     | $\mu\text{g}/\text{m}^3$   | $\mu\text{g}/\text{m}^3$   | $\mu\text{g}/\text{m}^3$ | $\mu\text{g}/\text{m}^3$ |       | $\mu\text{g}/\text{m}^3$ |       |
| Teddington<br>(Summer) | 97  | 11.2                       | 10.5                       | 10.9                     | 1.055                    | 1.985 | 2.09                     | 12    |
| Cologne<br>(Winter)    | 127 | 24.4                       | 25.7                       | 25.1                     | 1.704                    | 1.979 | 3.37                     | 7     |
| Bornheim<br>(Summer)   | 66  | 12.9                       | 13.4                       | 13.2                     | 1.110                    | 1.997 | 2.22                     | 11    |
| Teddington<br>(Winter) | 55  | 15.5                       | 16.6                       | 16.1                     | 0.941                    | 2.004 | 1.89                     | 13    |
| All sites              | 345 | 17.1                       | 17.6                       | 17.4                     | 1.338                    | 1.967 | 2.63                     | 10    |

- $\bar{c}$  (SN 17010): concentration averages device SN 17010
- $\bar{c}$  (SN 17011): concentration averages device SN 17011
- $\bar{c}_{ges}$ : concentration averages of the devices SN 17010 & SN 17011

The results of the individual measurements are presented in annex 4 of the appendix.

### **6.1 5.2.13 Hourly mean values**

*The measurement method shall allow formation of hourly mean values.*

### **6.2 Equipment**

Not required for this minimum requirement.

### **6.3 Carrying out the test**

The measuring systems were tested on the formation of hourly mean values.

### **6.4 Evaluation**

According to the valid Directive [7], the limits for particulate matter PM<sub>x</sub> are related to an averaging time of at least 24 hours. Hence, formation of hourly mean values is not required for measuring systems for monitoring the respective limits. The tested measuring systems operates by default with a measurement cycle of 60 min and thus outputs every hour a new measured value. Hence the measuring system allows an on-line measurement of the particulate concentrations with hourly resolution.

### **6.5 Assessment**

The formation of hourly averages for the component PM<sub>2.5</sub> is not necessary for the monitoring of the relevant limit values, but possible..

Minimum requirement fulfilled? -

### **6.6 Detailed representation of test results**

In the following figures, the course of the suspended particulate matter concentrations during the time period from 03/09/2009 until 03/28/2009 (Cologne, parking lot) as well as the correlation between both candidates on basis of 1 h-mean values is shown. The suitability of the measuring system for on-line measurement of the particulate concentrations with hourly resolution and therewith the possibility to supply information on the time courses of SPM concentrations is obviously demonstrated.

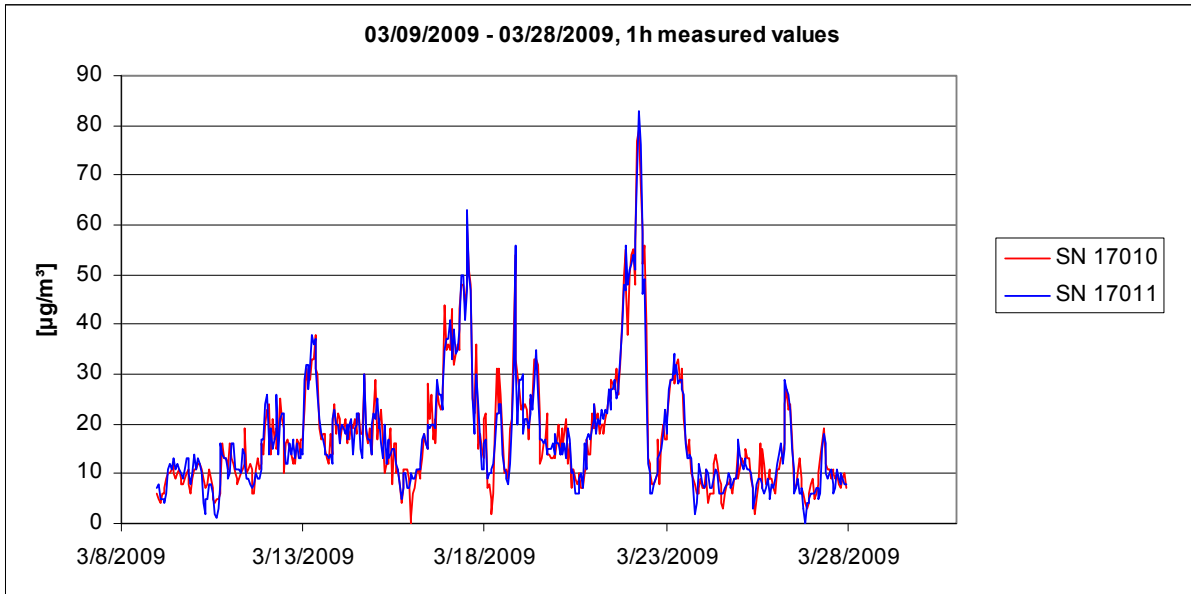

Figure 40: Course of time of the PM<sub>2.5</sub> concentrations from 03/09/2009 until 03/28/2009, 1h-mean values

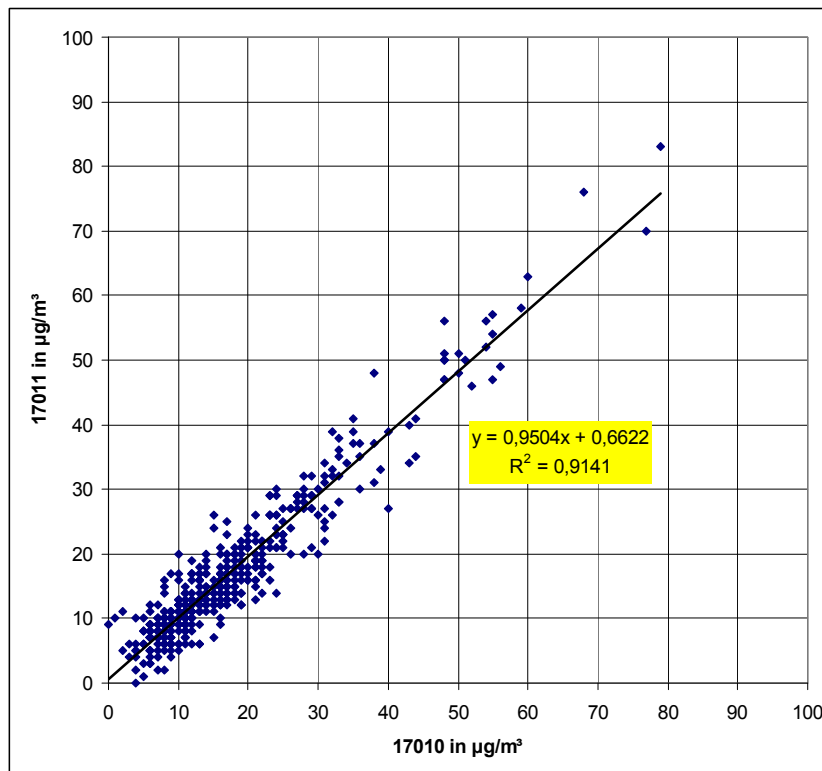

Figure 41: SN 17010 vs. SN 17011, 03/09/2009 until 03/28/2009, 1h-mean values

## **6.1 5.2.14 Mains voltage and frequency**

*The change in the measured values at reference value  $B_1$  caused by normal changes in the mains voltage in the interval (230 +15/-20) V shall not exceed  $B_0$ . In addition, for mobile applications the change in the measured value caused by changes in frequency of the mains voltage in the interval (50 ± 2) Hz shall not exceed  $B_0$ .*

## **6.2 Equipment**

Adjustable isolating transformer, built-in reference foils.

## **6.3 Carrying out the test**

To evaluate the dependency of the measured signal, the mains voltage was reduced from 230 V to 210 V and afterwards increased to 245 V *via* the intermediate stage of 230 V.

To check the dependence of the measured values on the mains voltage for the candidates SN 17010 and SN 17011, it is resorted to the count rates  $I_1$  (clean filter spot) respectively  $I_2$  (clean filter spot + retracted reference foil), which are determined at every measurement cycle (refer to point 3.2 Functionality of the measuring system). The mass density  $m$  [ $\mu\text{g}/\text{cm}^2$ ] of the reference foil is calculated device-internal from the determined count rates.

Since the measuring system is not intended for mobile use, an additional test on the dependency of the measured signal on frequency was omitted.

## **6.4 Evaluation**

The percentile change of the determined mass density value at span point was considered in relation to the starting point at 230 V for each test step.

As remark it should be mentioned, that only mass densities and no concentration values can be simulated by the application of the built-in reference foil, a consideration in the range of  $B_1$  (= 25  $\mu\text{g}/\text{m}^3$ ) was not possible because of this reason.

## **6.5 Assessment**

The assessment of the minimum requirements was based on the statements above.

No deviations > 0.1 % for device 1 (SN 17010) respectively > -0.1 % for device 2 (SN 17011) caused by mains voltage changes could be detected.

Minimum requirement fulfilled? yes

A value of 0.03  $\mu\text{g}/\text{m}^3$  (=0.1 % of 25  $\mu\text{g}/\text{m}^3$ ) was used for SN 17010 and -0.03  $\mu\text{g}/\text{m}^3$  (= -0.1 % of 25  $\mu\text{g}/\text{m}^3$ ) for SN 17011 to calculate uncertainty according to point 6.1 5.2.21

Total uncertainty.

## 6.6 Detailed representation of test results

Table 17 shows a summary of the test results.

*Table 17: Dependency of the measured value (Radiometry) on the mains voltage, Deviation in %, SN 17010*

| Mains voltage |             | Deviations Radiometry |                     |
|---------------|-------------|-----------------------|---------------------|
|               |             | Device 1 (SN 17010)   | Device 2 (SN 17011) |
| Start voltage | End voltage | Reference foil        | Reference foil      |
| V             | V           | %                     | %                   |
| 230           | 210         | 0.1                   | 0.0                 |
| 210           | 230         | 0.0                   | -0.1                |
| 230           | 245         | 0.0                   | 0.0                 |
| 245           | 230         | 0.1                   | -0.1                |

The results of the individual measurements are presented in annex 3 of the appendix.

## **6.1 5.2.15 Power outage**

*In case of malfunction of the measuring system or failure in the mains voltage, uncontrolled emission of operation and calibration gas shall be avoided. The instrument parameters shall be secured by buffering against loss caused by failure in the mains voltage. When mains voltage returns, the instrument shall automatically reach the operation mode and start the measurement according to the operating instructions.*

## **6.2 Equipment**

Not required for this minimum requirement.

## **6.3 Carrying out the test**

A power outage was simulated in order to determine whether the device will remain intact and will be ready for measurement as soon as the mains voltage returns.

## **6.4 Evaluation**

Uncontrolled gas emission is not possible as the devices neither need operation nor calibration gases.

In case of a power loss, the measuring systems restarts independently the next measurement cycle and thus again the measuring operations with reaching the next hour (refer to point 6.1 4.1.4 Setup- and warm-up times).

## **6.5 Assessment**

All instrument parameters are protected against loss by buffering. The measuring system is in normal operating condition after return of power supply and continues independently the measurements with reaching the next hour.

Minimum requirement fulfilled? yes

## **6.6 Detailed representation of test results**

Not required for this minimum requirement.

## **6.1 5.2.16 Operating states**

*Measuring systems shall be able to telemetrically transmit important operating states by status signals.*

## **6.2 Equipment**

Modem, PC for data acquisition (RS 232-host-device)

## **6.3 Carrying out the test**

A modem has been connected to the measuring system. By remote data recording, i.e. the status signals of the device have been recorded.

## **6.4 Evaluation**

The measuring system allows the complete telemetric check and control of the measuring system. There is a series of read, write and control commands available. A complete overview can be found in the manual of the measuring system.

## **6.5 Assessment**

The measuring systems can be controlled and monitored extensively from an external PC via a modem.

Minimum requirement fulfilled? yes

## **6.6 Detailed representation of test results**

Not required for this minimum requirement.



## **6.1 5.2.17 Switchover**

*Switchover between measurement and functional check and/or calibration shall be possible telemetrically by computer control or manual intervention.*

## **6.2 Equipment**

Not required for this minimum requirement.

## **6.3 Carrying out the test**

The measuring device can be monitored as well as partly controlled by the user at the device or by telemetric remote control. The internal checks of the zero and reference point are an integral part of each measurement cycle and are stored in the device respectively offered via the serial interface.

Some function, i.e. the performance of the extensive self-test of the measuring system, can only be activated directly at the device.

## **6.4 Evaluation**

All operational procedures can be monitored as well by the user at the device as by telemetric remote control. The internal checks of the zero and reference point are an integral part of each measurement cycle and are stored in the device respectively offered via the serial interface.

## **6.5 Assessment**

Generally all necessary operations for functional check and calibration can be monitored directly at the device or via telemetric remote control.

Minimum requirement fulfilled? yes

## **6.6 Detailed representation of test results**

Not required for this minimum requirement.

## **6.1 5.2.18 Availability**

*The availability of the measuring system shall be at least 90 %.*

## **6.2 Equipment**

Not required for this minimum requirement.

## **6.3 Carrying out the test**

Starting time and ending time of the availability tests were defined by the start and end of the field tests at each site. All measurement interruptions, e.g. due to system outage or maintenance works, were considered for this test.

## **6.4 Evaluation**

Table 18 and Table 19 show a compilation of the operation, maintenance and malfunction times. The measuring systems have been operated over a time period of 373 measuring days during the field test. This time period includes 12 days of zero filter operation (refer to annex 4).

Losses caused by external influences, which cannot be charged to the device itself, have been recorded on 08/06/2008 and 08/07/2008 (48 h due to power loss). Furthermore all measuring devices were shut down between 10/17/2008 and 20/20/2008 (for SN 17011 additionally 08/12/2009 (repair of SN 17010)). Therefore the total operating time is reduced to 367 (SN 17010) respectively 366 (SN 17011) measuring days.

The following malfunctions of the devices have been observed:

There have been 3 days of loss for SN 17010 because of cracked filter tape. Moreover irregularities (spikes) in the concentration and in the stability values (internal zero check) have been recorded at the beginning of test site Bornheim. It turned out, that the detector (PMT) of the device was responsible for the spikes due to unknown reasons. The detector was changed on-site on 08/12/2009. The parameters for device calibration, implemented in the device, remained untouched. The trouble with the detector lead in total to a device outage of 4 days.

There has been 1 day of loss for SN 17011 due to a stuck reference foil and another 2 days due to cracked filter tape.

No further malfunctions of the devices have been observed.

The regular cleaning of the sampling inlets in the maintenance interval, the change of the filter tape (approx. every 2 months) and the regular check of the flow rates respectively of the tightness have in each case lead to outages of less than 1 h per device (outage time = 1 cycle). The performance of these actions have lead to outages of less than 1 h per device (in total 16 times during the test) and do not lead to the rejection of the affected daily mean value.

## 6.5 Assessment

The availability amounts to 97.9 % for device SN 17010 and 99.0 % for device SN 17011 without test-related outage times. Those included, the availability amounts to 94.6 % for device SN 17010 and 95.7 % for device SN 17011.

Minimum requirement fulfilled? yes

## 6.6 Detailed representation of test results

*Table 18: Determination of availability (without test-related outages)*

|                       |   | Device 1 (SN 17010) | Device 2 (SN 17011) |
|-----------------------|---|---------------------|---------------------|
| Operating time        | h | 8808                | 8784                |
| Outage time           | h | 168                 | 72                  |
| Maintenance           | h | 16                  | 16                  |
| Actual operating time | h | 8624                | 8696                |
| Availability          | % | 97.9                | 99.0                |

*Table 19: Determination of availability (including test-related outages)*

|                               |   | Device 1 (SN 17010) | Device 2 (SN 17011) |
|-------------------------------|---|---------------------|---------------------|
| Operating time                | h | 8808                | 8784                |
| Outage time                   | h | 168                 | 72                  |
| Maintenance incl. zero filter | h | 288 + 16            | 288 + 16            |
| Actual operating time         | h | 8336                | 8408                |
| Availability                  | % | 94.6                | 95.7                |

## **6.1 5.2.19 Converter efficiency**

*In case of measuring systems with a converter, the efficiency of the converter shall be at least 95 %.*

According to Standard VDI Sheet 3, point 5.3, this test point is not relevant for particulate measuring systems with pre-separation, based on a physical measurement method for mass determination.

## **6.2 Equipment**

Not applicable.

## **6.3 Carrying out the test**

Not applicable.

## **6.4 Evaluation**

Not applicable.

## **6.5 Assessment**

Not applicable.

Minimum requirement fulfilled? -

## **6.6 Detailed representation of test results**

Not applicable.

## **6.1 5.2.20 Maintenance interval**

*The maintenance interval of the measuring system shall be determined and specified.  
The maintenance interval should be 28 days, if possible, but at least 14 days.*

## **6.2 Equipment**

Not required for this minimum requirement.

## **6.3 Carrying out the test**

This test was done in order to determine which maintenance works are required at which period to maintain correct functionality of the measuring system. Moreover, the results of the drift test for zero and span point according to module 5.2.9 and module 5.2.10 were included into the determination of the maintenance interval.

## **6.4 Evaluation**

No unacceptable drifts were detected for the measuring devices during the entire field test period.

Therefore, the maintenance interval is determined by upcoming maintenance works (refer to module 4.1.2).

During operation, the maintenance works can be limited to contamination, plausibility and status / error message checks.

## **6.5 Assessment**

The maintenance interval is defined by necessary maintenance works and is 1 month.

Minimum requirement fulfilled? yes

## **6.6 Detailed representation of test results**

Necessary maintenance works can be found in module 4.1.2 of this report and in chapter 7 of the operating manual.

## 6.1 5.2.21 Total uncertainty

*The expanded uncertainty of the measuring system shall be determined. The value determined shall not exceed the corresponding data quality objectives in the EU Daughter Standards on air quality [G11 to G13].*

## 6.2 Equipment

Not required for this minimum requirement.

## 6.3 Carrying out the test

The expanded total uncertainty of the AMS was determined for individual concentration values within the short time ambient air limit range and average concentration values within the long time ambient air limit range. The determined parameters of the measuring devices were compiled.

The following reference values were set:

Short time ambient air limit value:

PM<sub>2.5</sub> 35 µg/m<sup>3</sup> (Source: EN 14907, pt 9.4 in consideration of Table 2)

Long time ambient air limit value:

PM<sub>2.5</sub> 25 µg/m<sup>3</sup>

## 6.4 Evaluation

The expanded total uncertainty of the measuring system was determined according to VDI Standard 4202, sheet 1, annex C [1].

## 6.5 Assessment

The individual uncertainties of each test parameter were included in the calculation of the expanded total uncertainty. The worst result was taken in case more than one individual result was available

The determined total uncertainties were 14.64 % respectively 15.29 % for U(c) and 10.05 % respectively 12.35 % for U( $\bar{c}$ ).

Table 20 to Table 23 show the individual values. All calculated values are below the required total uncertainties of 25 %.

Minimum requirement fulfilled? yes

## 6.6 Detailed representation of test results

Table 20: Expanded measurement uncertainty  $U(c)$  for device SN 17010,  
 PM<sub>2.5</sub>, reference value: 35  $\mu\text{g}/\text{m}^3$

| Performance characteristic for<br>Device SN 17010  | Requirement                       | Result |                          | Uncertainty<br>$u$       | Square of<br>uncertainty $u^2$ |
|--|-----------------------------------|--------|--------------------------|--------------------------|--------------------------------|
|  |                                   |        |                          | $\mu\text{g}/\text{m}^3$ | $(\mu\text{g}/\text{m}^3)^2$   |
| Reproducibility $R_D$                              | $\geq 10$                         | 10     |                          | 2.00                     | 4.00                           |
| In-between uncertainty $u_{Bs}$ according to guide | $\leq 2,5 \mu\text{g}/\text{m}^3$ | 1.38   | $\mu\text{g}/\text{m}^3$ | 0.80                     | 0.63                           |
| Temperature dependence at zero point               | $\leq 2 \mu\text{g}/\text{m}^3$   | -1.20  | $\mu\text{g}/\text{m}^3$ | -0.69                    | 0.48                           |
| Temperature dependence at measured value (Beta)    | $\leq 5 \% \text{ of } B1$        | 0.05   | $\mu\text{g}/\text{m}^3$ | 0.03                     | 0.00                           |
| Drift at zero point                                | $\leq 2 \mu\text{g}/\text{m}^3$   | 1.80   | $\mu\text{g}/\text{m}^3$ | 1.04                     | 1.08                           |
| Drift at measured value (Beta)                     | $\leq 5 \% \text{ of } B1$        | 0.13   | $\mu\text{g}/\text{m}^3$ | 0.07                     | 0.01                           |
| Mains voltage (measured value Beta)                | $\leq 2 \mu\text{g}/\text{m}^3$   | 0.03   | $\mu\text{g}/\text{m}^3$ | 0.02                     | 0.00                           |
| Cross-sensitivities                                | $\leq 2,5 \mu\text{g}/\text{m}^3$ | 0.30   | $\mu\text{g}/\text{m}^3$ | 0.17                     | 0.03                           |
| Uncertainty of test standard                       | $\leq 1 \mu\text{g}/\text{m}^3$   | 1.00   | $\mu\text{g}/\text{m}^3$ | 0.58                     | 0.33                           |
|  |                                   |        |                          | $\Sigma u^2$             | 6.56                           |
|  |                                   |        |                          | $U(c) = 2u(c)$           | 5.12                           |
|  |                                   |        |                          | $U(c) / \text{Ref.}$     | 14.64                          |

Table 21: Expanded measurement uncertainty  $U(c)$  for device SN 17011,  
 PM<sub>2.5</sub>, reference value: 35  $\mu\text{g}/\text{m}^3$

| Performance characteristic for<br>Device SN 17011  | Requirement                       | Result |                          | Uncertainty<br>$u$       | Square of<br>uncertainty $u^2$ |
|--|-----------------------------------|--------|--------------------------|--------------------------|--------------------------------|
|  |                                   |        |                          | $\mu\text{g}/\text{m}^3$ | $(\mu\text{g}/\text{m}^3)^2$   |
| Reproducibility $R_D$                              | $\geq 10$                         | 10     |                          | 2.00                     | 4.00                           |
| In-between uncertainty $u_{Bs}$ according to guide | $\leq 2,5 \mu\text{g}/\text{m}^3$ | 1.38   | $\mu\text{g}/\text{m}^3$ | 0.80                     | 0.63                           |
| Temperature dependence at zero point               | $\leq 2 \mu\text{g}/\text{m}^3$   | -1.60  | $\mu\text{g}/\text{m}^3$ | -0.92                    | 0.85                           |
| Temperature dependence at measured value (Beta)    | $\leq 5 \% \text{ of } B1$        | 0.08   | $\mu\text{g}/\text{m}^3$ | 0.05                     | 0.00                           |
| Drift at zero point                                | $\leq 2 \mu\text{g}/\text{m}^3$   | 1.60   | $\mu\text{g}/\text{m}^3$ | 0.92                     | 0.85                           |
| Drift at measured value (Beta)                     | $\leq 5 \% \text{ of } B1$        | -0.13  | $\mu\text{g}/\text{m}^3$ | -0.07                    | 0.01                           |
| Mains voltage (measured value Beta)                | $\leq 2 \mu\text{g}/\text{m}^3$   | -0.03  | $\mu\text{g}/\text{m}^3$ | -0.02                    | 0.00                           |
| Cross-sensitivities                                | $\leq 2,5 \mu\text{g}/\text{m}^3$ | 1.20   | $\mu\text{g}/\text{m}^3$ | 0.69                     | 0.48                           |
| Uncertainty of test standard                       | $\leq 1 \mu\text{g}/\text{m}^3$   | 1.00   | $\mu\text{g}/\text{m}^3$ | 0.58                     | 0.33                           |
|  |                                   |        |                          | $\Sigma u^2$             | 7.16                           |
|  |                                   |        |                          | $U(c) = 2u(c)$           | 5.35                           |
|  |                                   |        |                          | $U(c) / \text{Ref.}$     | 15.29                          |

Report on the suitability test of the ambient air quality measurement system  
BAM-1020 with PM2.5 pre-separator of the company Met One Instruments,  
Inc. for the component suspended particulate matter PM2.5,  
Report No.: 936/21209919/A

Page 103 of 285

**Table 22:** Expanded measurement uncertainty  $U(c)$  for device SN 17010,  
 $PM_{2.5}$ , reference value:  $25 \mu\text{g}/\text{m}^3$

| Performance characteristic for<br>Device SN 17010  | Uncertainty<br>(Single value) | Time base | Number<br>nk | Square of<br>uncertainty (mean value)<br>$(\mu\text{g}/\text{m}^3)^2$ |       |
|--|-------------------------------|-----------|--------------|---|-------|
| Reproducibility $R_D$                              | 2.00                          | 24 hours  | 365          | 0.011   |       |
| In-between uncertainty $u_{Bs}$ according to guide | 0.80                          | 1 year    | 1            | 0.633   |       |
| Temperature dependence at zero point               | -0.69                         | 1 year    | 1            | 0.480   |       |
| Temperature dependence at measured value (Beta)    | 0.03                          | 1 year    | 1            | 0.001   |       |
| Drift at zero point                                | 1.04                          | 1 month   | 12           | 0.090   |       |
| Drift at measured value (Beta)                     | 0.07                          | 1 month   | 12           | 0.000   |       |
| Mains voltage (measured value Beta)                | 0.02                          | 1 year    | 1            | 0.000   |       |
| Cross-sensitivities                                | 0.17                          | 1 year    | 1            | 0.030   |       |
| Uncertainty of test standard                       | 0.58                          | 1 year    | 1            | 0.333   |       |
|  |                               |           |              | $\Sigma u_m^2(c_k)$   | 1.579 |
|  |                               |           |              | $U(\bar{c}) = 2u(\bar{c})$  | 2.51  |
|  |                               |           |              | $\frac{U(\bar{c})}{\text{Re f.}}$                                     | 10.05 |

**Table 23:** Expanded measurement uncertainty  $U(c)$  for device SN 17011,  
 $PM_{2.5}$ , reference value:  $25 \mu\text{g}/\text{m}^3$

| Performance characteristic for<br>Device SN 17011  | Uncertainty<br>(Single value) | Time base | Number<br>nk | Square of<br>uncertainty (mean value)<br>$(\mu\text{g}/\text{m}^3)^2$ |       |
|--|-------------------------------|-----------|--------------|---|-------|
| Reproducibility $R_D$                              | 2.00                          | 24 hours  | 365          | 0.011   |       |
| In-between uncertainty $u_{Bs}$ according to guide | 0.80                          | 1 year    | 1            | 0.633   |       |
| Temperature dependence at zero point               | -0.92                         | 1 year    | 1            | 0.853   |       |
| Temperature dependence at measured value (Beta)    | 0.05                          | 1 year    | 1            | 0.002   |       |
| Drift at zero point                                | 0.92                          | 1 month   | 12           | 0.071   |       |
| Drift at measured value (Beta)                     | -0.07                         | 1 month   | 12           | 0.000   |       |
| Mains voltage (measured value Beta)                | -0.02                         | 1 year    | 1            | 0.000   |       |
| Cross-sensitivities                                | 0.69                          | 1 year    | 1            | 0.480   |       |
| Uncertainty of test standard                       | 0.58                          | 1 year    | 1            | 0.333   |       |
|  |                               |           |              | $\Sigma u_m^2(c_k)$   | 2.385 |
|  |                               |           |              | $U(\bar{c}) = 2u(\bar{c})$  | 3.09  |
|  |                               |           |              | $\frac{U(\bar{c})}{\text{Re f.}}$                                     | 12.35 |



## **6.1 5.3.1 Equivalency of the sampling system**

*The equivalency between the PM<sub>10</sub> sampling system and the reference method according to EN 12 341 [T5] shall be demonstrated.*

## **6.2 Equipment**

Not applicable for PM<sub>2.5</sub> sampling systems. Please refer to chapter 7 of this report.

## **6.3 Carrying out the test**

Not applicable for PM<sub>2.5</sub> sampling systems. Please refer to chapter 7 of this report.

## **6.4 Evaluation**

Not applicable for PM<sub>2.5</sub> sampling systems. Please refer to chapter 7 of this report.

## **6.5 Assessment**

Not applicable for PM<sub>2.5</sub> sampling systems. Please refer to chapter 7 of this report.

Minimum requirement fulfilled? -

## **6.6 Detailed representation of test results**

Not applicable for PM<sub>2.5</sub> sampling systems. Please refer to chapter 7 of this report.

## 6.1 5.3.2 Reproducibility of the sampling system

*The PM<sub>10</sub> sampling systems of two identical candidate systems shall be reproducible among themselves according to EN 12 341 [T5]. This shall be demonstrated in the field test.*

## 6.2 Equipment

Not applicable for PM<sub>2.5</sub> sampling systems. Please refer to chapter 7 of this report.

## 6.3 Carrying out the test

Not applicable for PM<sub>2.5</sub> sampling systems. Please refer to chapter 7 of this report.

## 6.4 Evaluation

Not applicable for PM<sub>2.5</sub> sampling systems. Please refer to chapter 7 of this report.

## 6.5 Assessment

Not applicable for PM<sub>2.5</sub> sampling systems. Please refer to chapter 7 of this report.

Minimum requirement fulfilled? -

## 6.6 Detailed representation of test results

Not applicable for PM<sub>2.5</sub> sampling systems. Please refer to chapter 7 of this report.

## **6.1 5.3.3 Calibration**

*The PM<sub>10</sub> candidate systems shall be calibrated in the field test by comparison measurements with a reference method according to DIN EN 12341 [T5]. Here, the relationship between the output signal and the gravimetrically determined reference concentration shall be determined as a steady function.*

The PM<sub>2.5</sub> candidate systems were compared with reference measurements according to EN 14907 during the field test.

The results of these investigations can be found in module 5.2.3.

## **6.2 Equipment**

Refer to Module 5.2.3.

## **6.3 Carrying out the test**

Refer to Module 5.2.3.

## **6.4 Evaluation**

Refer to Module 5.2.3.

## **6.5 Assessment**

Refer to Module 5.2.3.

Minimum requirement fulfilled? -

## **6.6 Detailed representation of test results**

Refer to Module 5.2.3.

## 6.1 5.3.4 Cross sensitivity

*The interference caused by humidity in the sample shall not exceed 10 % of  $B_1$  in the range of  $B_1$ . In case of a heated sampling line, the reproducibility to the gravimetric reference method shall be determined at the specified temperature.*

## 6.2 Equipment

Not required for this minimum requirement.

## 6.3 Carrying out the test

The interferences caused by humidity contained in the measured medium were determined under field conditions since a test at zero point under lab conditions did not lead to a reliable statement and the test is not feasible at span point (in the range of  $B_1$ ).

Alternatively, the differences between the determined reference value (= nominal value) and the measured value of the respective candidate system were calculated for days of more than 70 % relative humidity during field test, and the average difference was set as a conservative estimation of the interfering effect of humidity contained in the measured medium.

In addition, the reference-equivalence-functions were determined from the field investigations for days of more than 70 % relative humidity for both candidate systems.

## 6.4 Evaluation

The average difference between the determined reference value (= nominal value) and the measured value of the respective candidate system was calculated for days of more than 70 % relative humidity during field test, and the relative deviation of the average concentration was determined.

Reference value:  $B_1 = 25 \mu\text{g}/\text{m}^3$                       10 % of  $B_1 = 2.5 \mu\text{g}/\text{m}^3$

Further investigations were made to determine whether the comparability of the candidate systems with the reference method according to Guide „Demonstration of Equivalence of Ambient Air Monitoring Methods” [4] is also given at days of more than 70% relative humidity.

## 6.5 Assessment

No interferences caused by humidity, contained in the measured medium, which led to deviations of more than  $1.2 \mu\text{g}/\text{m}^3$  between nominal value and measured signal, could be detected. Negative influences on the measured value caused by varying relative air humidity were not detected. The comparability of the candidate systems according to Guide „Demonstration of Equivalence of Ambient Air Monitoring Methods” [4] is even given at days of more than 70 % relative humidity.

Minimum requirement fulfilled?  yes

## 6.6 Detailed representation of test results

Table 24 shows a summary of the results.

*Table 24: Deviation between the candidate system and the reference system at days of more than 70 % relative humidity*

| Field test, days of >70% relative humidity |                          |           |          |          |
|--|--------------------------|-----------|----------|----------|
|  |                          | Reference | SN 17010 | SN 17011 |
| Average                                    | $\mu\text{g}/\text{m}^3$ | 16.8      | 17.1     | 18.0     |
| Deviation from the average (reference)     | $\mu\text{g}/\text{m}^3$ | -         | 0.3      | 1.2      |
| Deviation from the average (reference)     | %                        | -         | 1.8      | 7.1      |
| Deviation from B1                          | %                        | -         | 1.2      | 4.8      |

The individual values are listed in annex 4 and 5 of the appendix.

The measurement uncertainties  $W_{CM}$  of days of more than 70% relative humidity are represented and assessed in Table 25 and Table 26. The individual values are listed in annex 4 and 5 of the appendix.

Table 25: Comparison SN 17010 vs. reference method, rel. humidity > 70 %, all sites

| Comparison candidate with reference according to<br>Guide "Demonstration of Equivalence of Ambient Air Monitoring Methods" |                        |  |          |                          |
|--|------------------------|--|----------|--------------------------|
| Candidate  | BAM-1020               | SN   | SN 17010 |                          |
| Test site  | All test sites, rH>70% | Limit value                                | 30       | $\mu\text{g}/\text{m}^3$ |
| Status of measured values  | Raw data               | Allowed uncertainty                        | 25       | %                        |
| Results of regression analysis   |                        |  |          |                          |
| Slope b  | <b>0.991</b>           | <b>not significant</b>                     |          |                          |
| Uncertainty of b   | <b>0.02</b>            |  |          |                          |
| Ordinate intercept a   | <b>0.457</b>           | <b>not significant</b>                     |          |                          |
| Uncertainty of a   | <b>0.30</b>            |  |          |                          |
| Results of equivalence test  |                        |  |          |                          |
| Deviation at limit value   | <b>0.20</b>            | <b><math>\mu\text{g}/\text{m}^3</math></b> |          |                          |
| Uncertainty $u_{c,s}$ at limit value   | <b>1.80</b>            | <b><math>\mu\text{g}/\text{m}^3</math></b> |          |                          |
| Combined measurement uncertainty $w_{CM}$  | <b>6.00</b>            | <b>%</b>                                   |          |                          |
| Expanded measurement uncertainty $W_{CM}$  | <b>12.00</b>           | <b>%</b>                                   |          |                          |
| Status equivalence test  | <b>passed</b>          |  |          |                          |

Table 26: Comparison SN 17011 vs. reference method, rel. humidity > 70 %, all sites

| Comparison candidate with reference according to<br>Guide "Demonstration of Equivalence of Ambient Air Monitoring Methods" |                        |  |          |                          |
|--|------------------------|--|----------|--------------------------|
| Candidate  | BAM-1020               | SN   | SN 17011 |                          |
| Test site  | All test sites, rH>70% | Limit value                                | 30       | $\mu\text{g}/\text{m}^3$ |
| Status of measured values  | Raw data               | Allowed uncertainty                        | 25       | %                        |
| Results of regression analysis   |                        |  |          |                          |
| Slope b  | <b>1.047</b>           | <b>significant</b>                         |          |                          |
| Uncertainty of b   | <b>0.01</b>            |  |          |                          |
| Ordinate intercept a   | <b>0.434</b>           | <b>not significant</b>                     |          |                          |
| Uncertainty of a   | <b>0.26</b>            |  |          |                          |
| Results of equivalence test  |                        |  |          |                          |
| Deviation at limit value   | <b>1.85</b>            | <b><math>\mu\text{g}/\text{m}^3</math></b> |          |                          |
| Uncertainty $u_{c,s}$ at limit value   | <b>2.41</b>            | <b><math>\mu\text{g}/\text{m}^3</math></b> |          |                          |
| Combined measurement uncertainty $w_{CM}$  | <b>8.03</b>            | <b>%</b>                                   |          |                          |
| Expanded measurement uncertainty $W_{CM}$  | <b>16.05</b>           | <b>%</b>                                   |          |                          |
| Status equivalence test  | <b>passed</b>          |  |          |                          |

## **6.1 5.3.5 Daily averages**

*The measuring system shall allow for formation of daily averages. In case of filter changes, the time needed for the filter changes shall not exceed 1 % of the averaging time.*

## **6.2 Equipment**

A clock was additionally used for this test.

## **6.3 Carrying out the test**

It has been checked, whether the measuring system allows the formation of a daily average. The time need for a filter change has been determined.

## **6.4 Evaluation**

The measuring system operates by default with a measurement cycle of 60 min. After each measurement cycle, the filter tape is moved forward for one position. The data of each measurement cycle are stored and are available for the user for further processing. Furthermore the measuring system allows the formation of a 24-h-mean value, which is output in the daily protocol via the serial interface.

Within the scope of the suitability test, the cycle time has been set to 60 min with a time need for the radiometric measurement of respectively 8min.

The cycle time therefore consists of 2 x 8 min for the radiometric measurement ( $I_0$  &  $I_3$ ) as well as approx. 1-2 min for filter tape movements. Hence the sampling time is approx. 42 min per hour.

Thus the available sampling time per measurement cycle is approx. 70 % of the total cycle time. The results from the field investigations according to point 7.1 Calculation of the expanded uncertainty of the instruments [9.5.2.2-9.5.6] in this report show, that the comparability of the candidates with the reference method could be securely proved in case of this system configuration and thus the formation of daily mean values is securely possible.

## **6.5 Assessment**

With the described system configuration and with a measurement cycle of 60 min, the formation of valid daily averages on the basis of 24 single measurements is possible.

Minimum requirement fulfilled? yes

## **6.6 Detailed representation of test results**

Not required for this minimum requirement.

**6.1 5.3.6 Constancy of sample volumetric flow**

*The sample volumetric flow averaged over the sampling time shall be constant within ± 3 % of the rated value. All instantaneous values of the sample volumetric flow shall be within a range of ± 5 % of the rated value during sampling.*

**6.2 Equipment**

Volumetric flow measuring systems according to point 4

**6.3 Carrying out the test**

The sample volumetric flow has been calibrated before the first field test site and afterwards checked on correctness and adjusted if necessary before each field test site with the help of a dry gas meter respectively a mass flow meter.

In order to determine the constancy of the sampling volumetric flow, a flow meter was connected to the measuring devices and the flow rate was recorded as 5-second-values and evaluated over a time period of 24 h (= 24 measurement cycles).

**6.4 Evaluation**

From the determined measured values for the flow rate, the mean value, the standard deviation as well as maximum and minimum value have been determined.

**6.5 Assessment**

Table 27 presents the results of the check on volumetric flow rate prior to each field test site.

*Table 27: Sample volumetric flow rate results*

| Volumetric flow check prior to<br>Site: | SN 17010, |                                  | SN 17011 |                                  |
|---|-----------|----------------------------------|----------|----------------------------------|
|   | [l/min]   | Deviation from nominal value [%] | [l/min]  | Deviation from nominal value [%] |
| Teddington, Summer                      | 16.3      | -2.4                             | 16.5     | -1.2                             |
| Cologne, Winter                         | 16.8      | 0.6                              | 16.7     | 0.0                              |
| Bornheim, Summer                        | 16.7      | 0.0                              | 16.9     | 1.2                              |
| Teddington, Winter                      | 16.5      | -1.2                             | 16.6     | -0.6                             |



Graphical representations of the volumetric flow rates over 24 measurement cycles indicate that all measured values taken during sampling deviate less than  $\pm 5\%$  from the nominal value (16.67 l/min). Moreover, the deviation of the daily averages from the nominal value is less than  $\pm 3\%$ .

All determined daily averages deviate less than  $\pm 3\%$ , all individual values less than  $\pm 5\%$  from the nominal value.

Minimum requirement fulfilled?  yes

## 6.6 Detailed representation of test results

Table 28 and Table 29 present the determined parameters for the volumetric flow rate. Figure 42 and Figure 43 show a graphical representation of the flow rate measurements for both candidates SN 17010 and SN 17011.

*Table 28: Performance characteristics for flow rate measurement, SN 17010*

| No.              | Mean [l/min] | Dev. of nominal [%] | STD [l/min] | Max [l/min]  | Min [l/min]  |
|------------------|--------------|---------------------|-------------|--------------|--------------|
| 1                | 16.47        | -1.35               | 0.08        | 16.80        | 16.40        |
| 2                | 16.47        | -1.37               | 0.08        | 16.75        | 16.40        |
| 3                | 16.48        | -1.34               | 0.09        | 16.80        | 16.40        |
| 4                | 16.51        | -1.17               | 0.11        | 16.80        | 16.35        |
| 5                | 16.50        | -1.18               | 0.12        | 16.80        | 16.35        |
| 6                | 16.43        | -1.64               | 0.03        | 16.60        | 16.35        |
| 7                | 16.41        | -1.71               | 0.03        | 16.50        | 16.35        |
| 8                | 16.44        | -1.53               | 0.07        | 16.70        | 16.35        |
| 9                | 16.47        | -1.39               | 0.09        | 16.80        | 16.40        |
| 10               | 16.49        | -1.24               | 0.12        | 16.80        | 16.35        |
| 11               | 16.49        | -1.27               | 0.12        | 16.80        | 16.35        |
| 12               | 16.48        | -1.29               | 0.12        | 16.80        | 16.20        |
| 13               | 16.50        | -1.19               | 0.12        | 16.85        | 16.35        |
| 14               | 16.49        | -1.27               | 0.12        | 16.85        | 16.40        |
| 15               | 16.45        | -1.51               | 0.03        | 16.55        | 16.40        |
| 16               | 16.50        | -1.19               | 0.09        | 16.80        | 16.45        |
| 17               | 16.50        | -1.21               | 0.09        | 16.80        | 16.45        |
| 18               | 16.48        | -1.32               | 0.03        | 16.55        | 16.45        |
| 19               | 16.54        | -0.95               | 0.07        | 16.75        | 16.40        |
| 20               | 16.53        | -1.03               | 0.02        | 16.55        | 16.50        |
| 21               | 16.53        | -1.04               | 0.03        | 16.55        | 16.45        |
| 22               | 16.50        | -1.19               | 0.03        | 16.55        | 16.45        |
| 23               | 16.56        | -0.86               | 0.09        | 16.85        | 16.45        |
| 24               | 16.56        | -0.82               | 0.11        | 16.85        | 16.45        |
| <b>Mean 1-24</b> | <b>16.49</b> | <b>-1.25</b>        | <b>0.08</b> | <b>16.85</b> | <b>16.20</b> |

Table 29: Performance characteristics for flow rate measurement, SN 17011

| No.              | Mean [l/min] | Dev. of nominal [%] | STD [l/min] | Max [l/min]  | Min [l/min]  |
|------------------|--------------|---------------------|-------------|--------------|--------------|
| 1                | 16.68        | -0.12               | 0.03        | 16.75        | 16.65        |
| 2                | 16.65        | -0.28               | 0.02        | 16.70        | 16.60        |
| 3                | 16.64        | -0.38               | 0.05        | 16.70        | 16.50        |
| 4                | 16.63        | -0.41               | 0.05        | 16.70        | 16.35        |
| 5                | 16.62        | -0.49               | 0.05        | 16.70        | 16.45        |
| 6                | 16.63        | -0.45               | 0.06        | 16.70        | 16.40        |
| 7                | 16.62        | -0.45               | 0.06        | 16.75        | 16.45        |
| 8                | 16.62        | -0.48               | 0.06        | 16.75        | 16.45        |
| 9                | 16.61        | -0.52               | 0.05        | 16.70        | 16.40        |
| 10               | 16.62        | -0.51               | 0.06        | 16.70        | 16.45        |
| 11               | 16.58        | -0.74               | 0.05        | 16.65        | 16.45        |
| 12               | 16.60        | -0.62               | 0.03        | 16.65        | 16.55        |
| 13               | 16.48        | -1.34               | 0.06        | 16.60        | 16.30        |
| 14               | 16.48        | -1.32               | 0.04        | 16.55        | 16.40        |
| 15               | 16.54        | -0.97               | 0.04        | 16.65        | 16.40        |
| 16               | 16.54        | -0.98               | 0.05        | 16.60        | 16.45        |
| 17               | 16.48        | -1.34               | 0.06        | 16.60        | 16.30        |
| 18               | 16.62        | -0.47               | 0.04        | 16.70        | 16.55        |
| 19               | 16.72        | 0.11                | 0.04        | 16.80        | 16.60        |
| 20               | 16.59        | -0.65               | 0.07        | 16.75        | 16.45        |
| 21               | 16.74        | 0.22                | 0.04        | 16.85        | 16.65        |
| 22               | 16.78        | 0.47                | 0.03        | 16.80        | 16.70        |
| 23               | 16.80        | 0.57                | 0.03        | 16.85        | 16.70        |
| 24               | 16.80        | 0.63                | 0.03        | 16.85        | 16.70        |
| <b>Mean 1-24</b> | <b>16.63</b> | <b>-0.44</b>        | <b>0.05</b> | <b>16.85</b> | <b>16.30</b> |

SN 17010, Constancy of flow rate

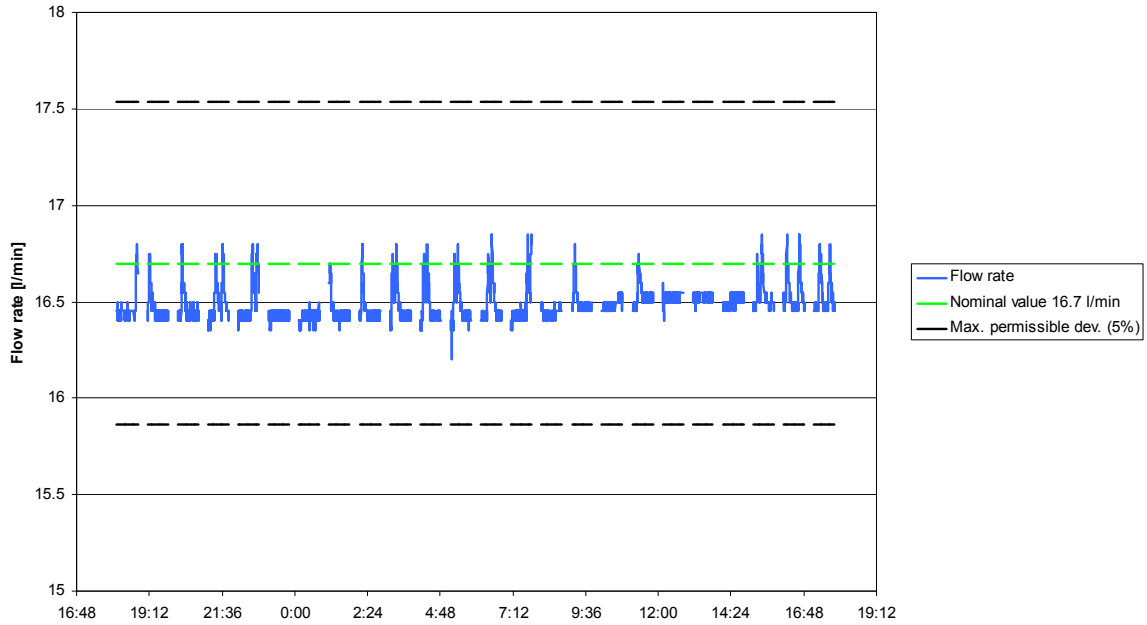

Figure 42: Flow rate of device SN 17010

SN 17011, Constancy of flow rate

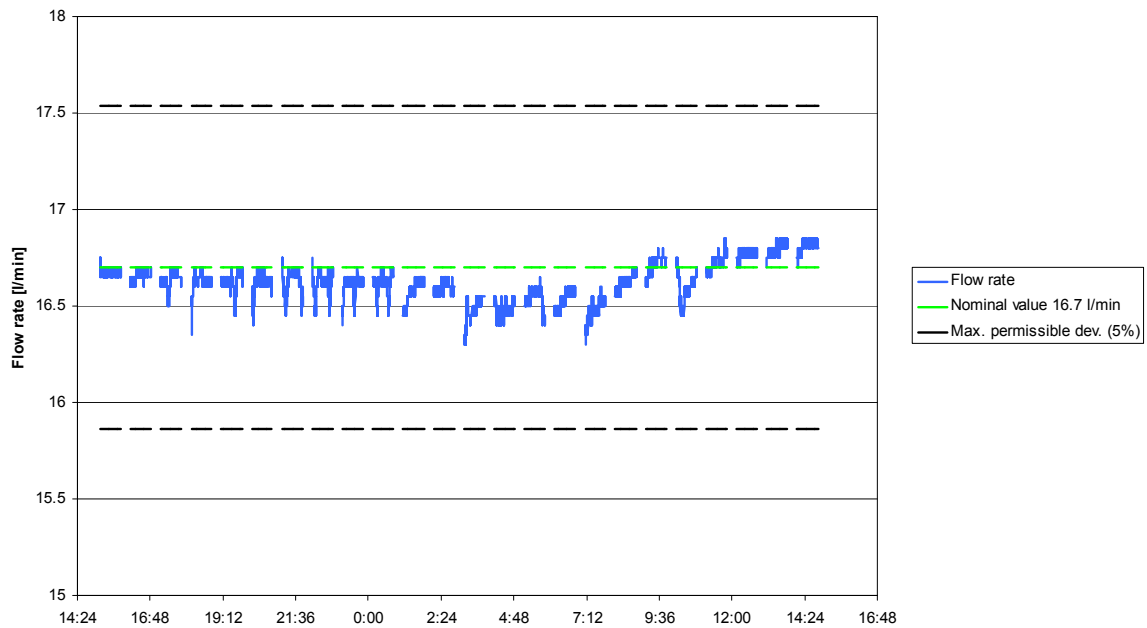

Figure 43: Flow rate of device SN 17011

## **6.1 5.3.7 Tightness of the sampling system**

*The complete sampling system shall be checked for tightness. Leakage shall not exceed 1 % of the in taken sample volume.*

## **6.2 Equipment**

Zero filter kit BX-302 respectively inlet adapter BX-305

## **6.3 Carrying out the test**

In order to determine the leak rate, the inlet adapter BX-305 has been installed at the inlet of the sampling tube and the ball valve of the adapter has been closed slowly. The leak rate has been determined from the difference between the flow rate with switched-off pump (zero point of flow rate measurement), measured in the device, and the measured flow rate with sealed instrument inlet.

The procedure has been repeated three times during the field test in Cologne.

It is recommended to check the tightness of the measuring device with the help of the described procedure once a month.

## **6.4 Evaluation**

The leak rate has been determined from the difference between the flow rate with switched-off pump (zero point of flow rate measurement), measured in the device, and the measured flow rate with sealed instrument inlet.

The maximum value of the three determined leak rates has been specified.

According to the manufacturer, a maximum leak rate up to 1 l/min is permissible under the prescribed test conditions, as in case of a completely sealed device inlet, a very high vacuum is created in the system (21 inch Hg corresponds to approx. 700 mbar), which is manifold higher than it could possibly be created by filter load during normal operation.

Possible leakages in the system (e.g. contamination in the area of the nozzle at the filter tape caused by filter abrasion) can be safely detected by the prescribed method.

## 6.5 Assessment

The maximum determined leakages have been 1.8 % for device 1 (SN 17010) as well as 2.4 % for device 2 (SN 17011). According to the minimum requirement, the leak rate shall not be greater than 1 % of the sample flow rate.

Minimum requirement fulfilled? no

According to the manufacturer, a maximum leak rate up to 1 l/min (approx. 6 % of 16.7 l/min) is permissible under the prescribed test conditions, as in case of a completely sealed device inlet, a very high vacuum is created in the system (21 inch Hg corresponds to approx. 700 mbar), which is manifold higher than it could possibly be created by filter load during normal operation. Possible leakages in the system (e.g. contamination in the area of the nozzle at the filter tape caused by filter abrasion) can be safely detected by the prescribed method

It is recommended to check the tightness of the measuring device with the help of the described procedure once a month.

## 6.6 Detailed representation of test results

Table 30 contains the determined values from the tightness test.

*Table 30: Determination of leak rate*

|             | Flow rate<br>(pump off) | Flow rate<br>(pump on, inlet sealed) |                 |                 | Mean  | Maximum leak<br>rate |
|-------------|-------------------------|--------------------------------------|-----------------|-----------------|-------|----------------------|
|             |                         | 1<br>(12/01/08)                      | 2<br>(01/26/09) | 3<br>(02/16/09) |       |                      |
|             | l/min                   | l/min                                | l/min           | l/min           | l/min | % of nom.<br>value   |
| SN<br>17010 | 0.0                     | 0.1                                  | 0.3             | 0.0             | 0.3   | 1.8                  |
| SN<br>17011 | 0.0                     | 0.1                                  | 0.4             | 0.3             | 0.4   | 2.4                  |

## **6.1 5.4 Requirements for multiple-component measuring systems**

*Multiple-component measuring systems shall comply with the requirements set for each component, also in the case of simultaneous operation of all measuring channels. In case of sequential operation, the formation of hourly averages shall be possible.*

### **6.2 Equipment**

Not applicable.

### **6.3 Carrying out the test**

Not applicable.

### **6.4 Evaluation**

Not applicable.

### **6.5 Assessment**

Not applicable.

Minimum requirement fulfilled? -

### **6.6 Detailed representation of test results**

Not applicable.

## 7 Additional test criteria according to Guide „Demonstration of Equivalence of Ambient Air Monitoring Methods“

### 7.1 Equivalence Methodology

According to the version of the Guide from July 2009 [4], the following 5 criteria must be fulfilled for the demonstration of equivalence:

1. Of the full dataset at least 20% of the results obtained using the standard method shall be greater than the upper assessment threshold specified in 2008/50/EC for annual limit values *i.e.*: 28 µg/m<sup>3</sup> for PM<sub>10</sub> and currently 17 µg/m<sup>3</sup> for PM<sub>2.5</sub>.
2. The intra instrument uncertainty of the candidate must be less than 2.5 µg/m<sup>3</sup> for all data and for two sub datasets corresponding to all the data split greater than or equal to and lower than 30 µg/m<sup>3</sup> or 18 µg/m<sup>3</sup> for PM<sub>10</sub> and PM<sub>2.5</sub> respectively.
3. The intra instrument uncertainty of the reference method must be less than 2.0 µg/m<sup>3</sup>.
4. The expanded uncertainty ( $W_{CM}$ ) is calculated at 50 µg/m<sup>3</sup> for PM<sub>10</sub> and 30 µg/m<sup>3</sup> for PM<sub>2.5</sub> for each individual candidate instrument against the average results of the reference method. For each of the following permutations, the expanded uncertainty must be less than 25 %:
  - Full dataset;
  - Datasets representing PM concentrations greater than or equal to 30 µg/m<sup>3</sup> for PM<sub>10</sub>, or concentrations greater than or equal to 18 µg/m<sup>3</sup> for PM<sub>2.5</sub>, provided that the subset contains 40 or more valid data pairs;
  - Datasets for each individual site.
5. Preconditions for acceptance of the full dataset are that: the slope  $b$  is insignificantly different from 1:  $|b - 1| \leq 2 \cdot u(b)$ , and the intercept  $a$  is insignificantly different from 0:  $|a| \leq 2 \cdot u(a)$ . If these preconditions are not met, the candidate method may be calibrated using the values obtained for slope and/or intercept of all paired instruments together.

The fulfillment of the 5 criteria is checked in the following chapters:

In chapter 7.1 Determination of the in-between-instrument uncertainty  $u_{bs}$  [9.5.2.1], the criteria 1 and 2 will be checked.

In chapter 7.1 Calculation of the expanded uncertainty of the instruments [9.5.2.2-9.5.6], the criteria 3,4 and 5 will be checked.

In chapter 7.1 Application of correction factors or terms [9.7] there is an exemplary evaluation for the case, that criterion 5 cannot be fulfilled without the application of correction factors or terms.

### 7.1 Determination of the in-between-instrument uncertainty $u_{bs}$ [9.5.2.1]

*The between-sampler uncertainty  $u_{bs}$  has to be determined according to point 9.5.2.1 of the Guide „Demonstration of Equivalence of Ambient Air Monitoring Methods“.*

### 7.2 Equipment

Not required for this minimum requirement.

### 7.3 Carrying out the test

The test was carried out at four different sites during field test. Different seasons and varying concentrations for PM<sub>2.5</sub> were taken into consideration.

Of the complete data set, at least 20 % of the concentration values, determined with the reference method, shall be greater than the upper assessment threshold according to 2008/50/EC [7]. For PM<sub>2.5</sub>, the upper assessment threshold is 17 µg/m<sup>3</sup>.

A minimum of 40 valid paired values were determined at each site. Of the entire data set (4 sites, 251 valid paired values for SN 17010, 253 valid paired values for SN 17011), a total of 33.1% are above of the upper assessment threshold is 17 µg/m<sup>3</sup> for the annual mean value of PM<sub>2.5</sub>. The measured concentrations were referred to ambient conditions.

### 7.4 Evaluation

According to **point 9.5.2.1** of Guide „Demonstration of Equivalence of Ambient Air Monitoring Methods“, it is imperative:

The in-between-instrument uncertainty  $u_{bs}$  shall be  $\leq 2.5$  µg/m<sup>3</sup>. An uncertainty larger than 2.5 µg/m<sup>3</sup> between the candidate systems is an indication of unsuitable performance of one or both instruments and that equivalency cannot be declared.

Uncertainty is hereby determined for:

- All sites (complete data set)
- 1 data set with measured values  $\geq 18$  µg/m<sup>3</sup> for PM<sub>2.5</sub> (Basis: average values of the reference measurement)



The in-between-instrument uncertainty  $u_{bs}$  is calculated from the differences of all 24-hour results of the simultaneously operated candidate systems according to the following equation:

$$u_{bs}^2 = \frac{\sum_{i=1}^n (y_{i,1} - y_{i,2})^2}{2n}$$

with  $y_{i,1}$  and  $y_{i,2}$  = results of the parallel measurements of individual 24h-values  $i$   
 $n$  = No. of 24h-values

## 7.5 Assessment

The in-between-instrument uncertainty between the candidates  $u_{bs}$  is at maximum  $1.57 \mu\text{g}/\text{m}^3$  and thus below the required value of  $2.5 \mu\text{g}/\text{m}^3$ .

Minimum requirement fulfilled? yes

A value of  $1.38 \mu\text{g}/\text{m}^3$  for the complete data set was used to calculate uncertainty according to point 6.1 5.2.21 Total uncertainty.

## 7.6 Detailed representation of test results

Table 31 presents the calculated in-between-instrument uncertainty  $u_{bs}$ . A graphical representation is given in Figure 44 to Figure 50.

Table 31: *In-between-instrument uncertainty  $u_{bs}$  for the devices SN 17010 and SN 17011*

| Test device                         | Site  | No. of Values | Uncertainty $u_{bs}$     |
|-------------------------------------|---|---------------|--------------------------|
| SN                                  |   |               | $\mu\text{g}/\text{m}^3$ |
| <b>17010 / 17011</b>                | <b>All sites</b>  | <b>345</b>    | <b>1.38</b>              |
| Single test sites                   |   |               |                          |
| 17010 / 17011                       | Teddington, Summer  | 97            | 1.13                     |
| 17010 / 17011                       | Cologne, Winter   | 127           | 1.76                     |
| 17010 / 17011                       | Bornheim, Summer  | 66            | 1.13                     |
| 17010 / 17011                       | Teddington, Winter  | 55            | 1.01                     |
| Classification via reference values |   |               |                          |
| <b>17010 / 17011</b>                | <b>Values <math>\geq 18 \mu\text{g}/\text{m}^3</math></b> | <b>174</b>    | <b>1.57</b>              |
| 17010 / 17011                       | Values $< 18 \mu\text{g}/\text{m}^3$                      | 74            | 1.05                     |

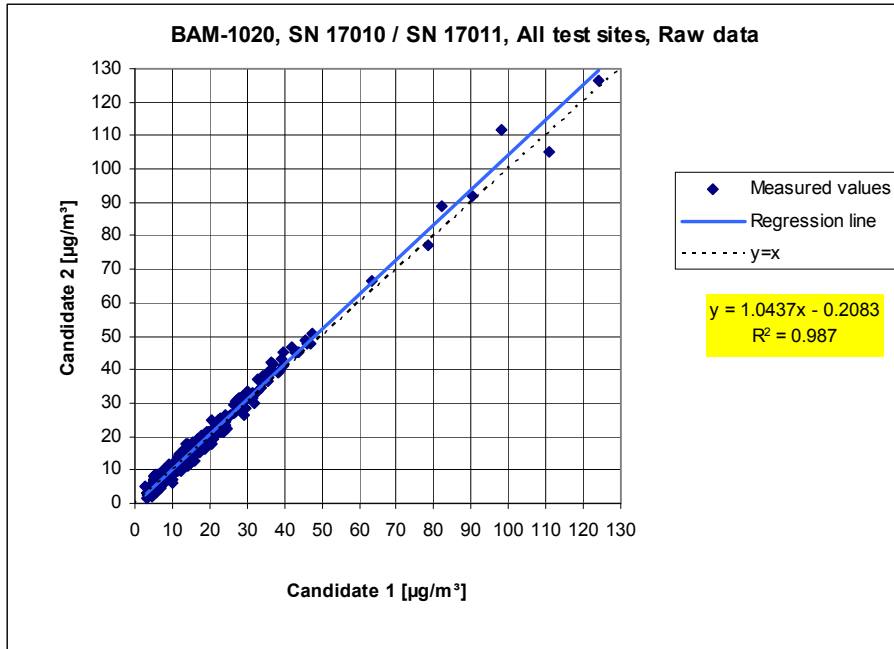

Figure 44: Results of the parallel measurements with device SN 17010 / SN 17011, all test sites

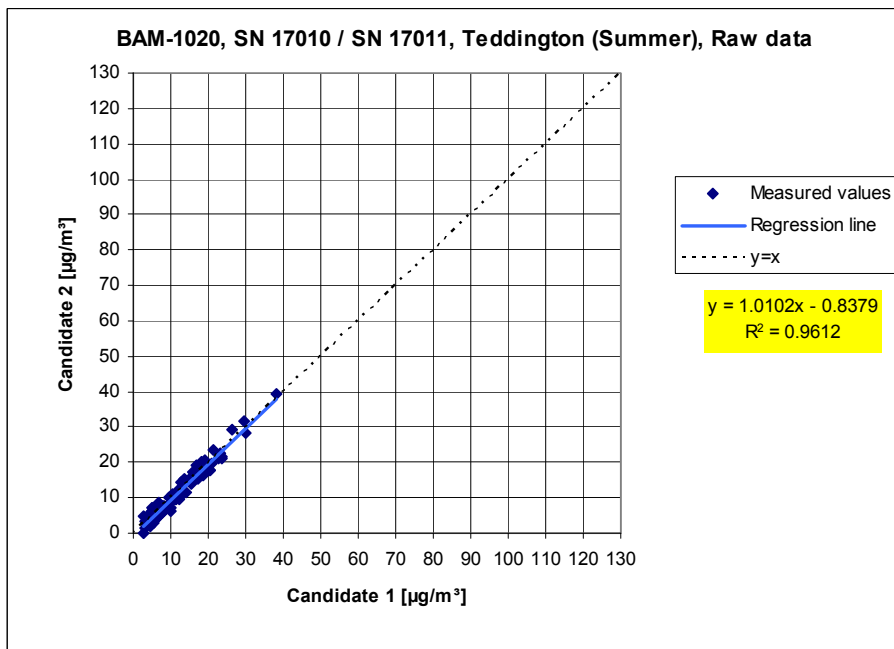

Figure 45: Results of the parallel measurements with device SN 17010 / SN 17011, test site "Teddington, Summer"

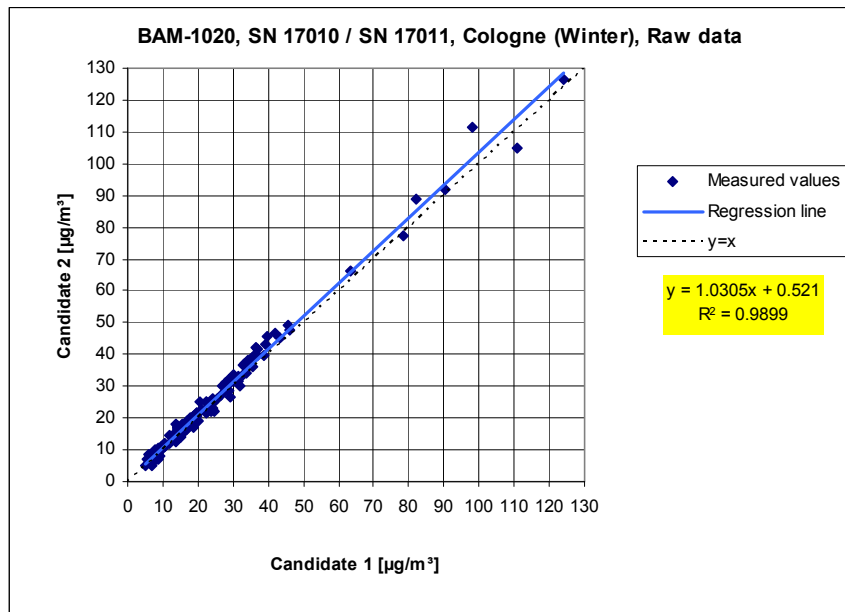

Figure 46: Results of the parallel measurements with device SN 17010 / SN 17011, test site “Cologne, Winter”

Remark: The deviations on the paired values 98.2 µg/m³ / 111.5 µg/m³ (Dec 31, 2008) as well as 110.7 µg/m³ / 105.1 µg/m³ (April 13, 2009) are caused by short-term local peaks (fireworks). As there are no technical reasons, the values have not been removed as outliers from the data pool (refer to chapter 4.3 Data handling)

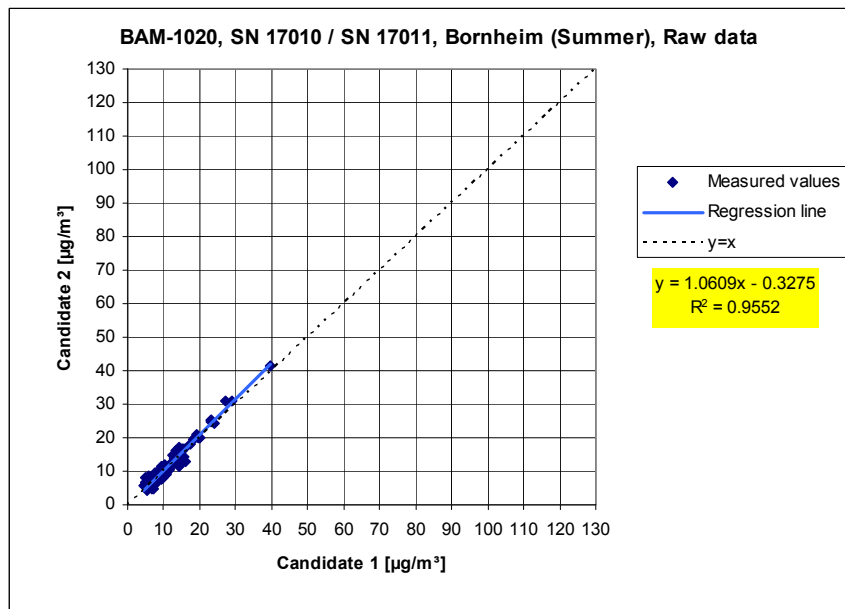

Figure 47: Results of the parallel measurements with device SN 17010 / SN 17011, test site “Bornheim, Summer”

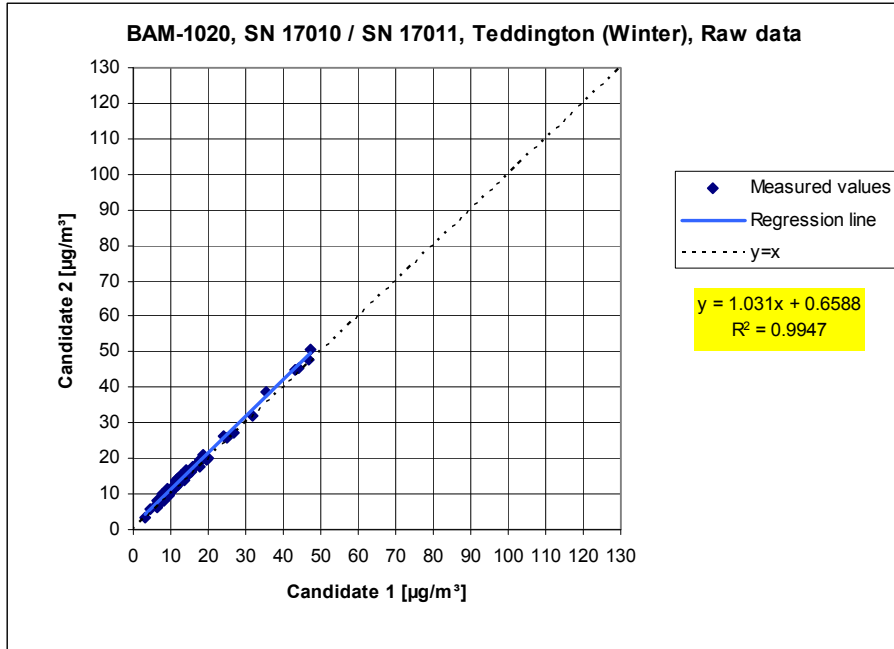

Figure 48: Results of the parallel measurements with device SN 17010 / SN 17011, test site “Teddington, Winter”

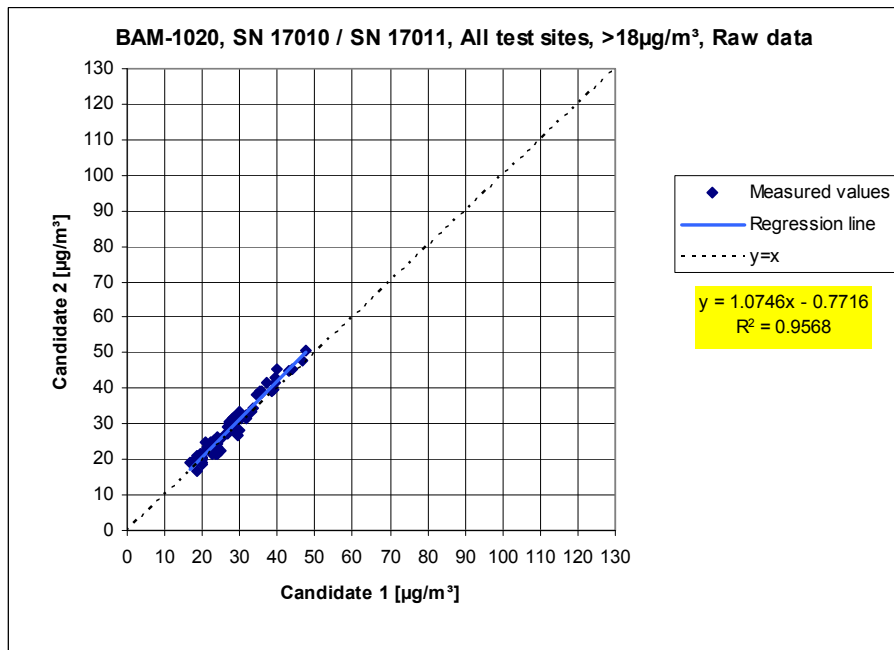

Figure 49: Results of the parallel measurements with device SN 17010 / SN 17011, all test sites, values  $\geq 18 \mu\text{g}/\text{m}^3$

Report on the suitability test of the ambient air quality measurement system  
BAM-1020 with PM2.5 pre-separator of the company Met One Instruments,  
Inc. for the component suspended particulate matter PM2.5,  
Report No.: 936/21209919/A

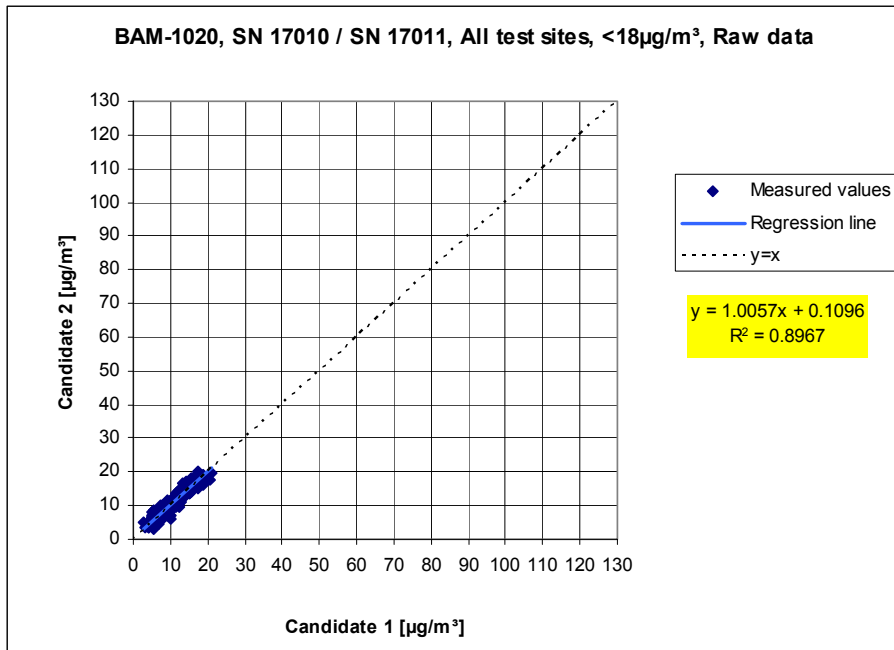

Figure 50: Results of the parallel measurements with device SN 17010 / SN 17011, all test sites, values < 18 µg/m³

## 7.1 Calculation of the expanded uncertainty of the instruments [9.5.2.2-9.5.6]

*The equivalency of the candidate instruments to the reference method has to be demonstrated according to the points 9.5.2.2 to 9.5.4 of the Guide „Demonstration of Equivalence of Ambient Air Monitoring Methods“. The highest resulting expanded uncertainty of the candidate method is to compare with the requirements on the data quality of ambient air measurements according to EU-guideline [7].*

## 7.2 Equipment

The devices mentioned in point 5 of the present report were additionally used for this test.

## 7.3 Carrying out the test

The test was carried out at four different sites during field test. Different seasons and varying concentrations for PM<sub>2.5</sub> were taken into consideration.

Of the complete data set, at least 20% of the concentration values, determined with the reference method, shall be greater than the upper assessment threshold according to 2008/50/EC [7]. For PM<sub>2.5</sub>, the upper assessment threshold is 17 µg/m<sup>3</sup>.

A minimum of 40 valid paired values were determined at each site. Of the entire data set (4 sites, 251 valid paired values for SN 17010, 253 valid paired values for SN 17011), a total of 33.1% are above of the upper assessment threshold is 17 µg/m<sup>3</sup> for the annual mean value of PM<sub>2.5</sub>. The measured concentrations were referred to ambient conditions.

## 7.4 Evaluation

[Point 9.5.2.2] The calculation of the in-between-instrument uncertainty  $u_{ref}$  of the reference devices is carried out prior to the calculation of the expanded uncertainty of the candidates.

The in-between-instrument uncertainty  $u_{ref}$  of the reference devices shall be  $\leq 2 \mu\text{g}/\text{m}^3$ .

Section 7.6 of this test point shows the evaluated results.

A linear correlation  $y_i = a + bx_i$  is assumed between the results of both methods in order to evaluate the comparability of the candidates  $y$  and the reference procedure  $x$ . The correlation between the average values of the reference devices and the candidates is established by orthogonal regression.

Regression is calculated for:

- All test sites
- Each test site separately
- 1 data set with measured values  $\geq 18 \mu\text{g}/\text{m}^3$  (Basis: average values of the reference measurement)

For further evaluation, the results of the uncertainty  $u_{c,s}$  of the candidates compared with the reference method are described with the following equation, which describes  $u_{CR}$  as a function of the PM concentration  $x_i$  :

$$u_{CR}^2(y_i) = \frac{RSS}{(n-2)} - u^2(x_i) + [a + (b-1)x_i]^2$$

With RSS = Sum of the (relative) residuals from orthogonal regression

$u(x_i)$  = random uncertainty of the reference procedure if value  $u_{bs}$ ,  
which is calculated for using the candidates, can be used in this test  
(refer to point 7.1 Determination of the in-between-instrument uncertainty  
 $u_{bs}$  [9.5.2.1])

Algorithm for the calculation of ordinate intercept  $a$  as well as slope  $b$  and its variances by orthogonal regression are described in detail in annex B of [4].

The sum of the (relative) residuals RSS is calculated by the following equation:

$$RSS = \sum_{i=1}^n (y_i - a - bx_i)^2$$

Uncertainty  $u_{c,s}$  is calculated for:

- All test sites
- Each test site separately
- 1 data set with measured values  $\geq 18 \mu\text{g}/\text{m}^3$  (Basis: average values of the reference measurement)

Preconditions for acceptance of the full dataset are that:

- The slope  $b$  is significantly different from 1:  $|b-1| \leq 2 \cdot u(b)$

and

- The intercept  $a$  is insignificantly different from 0:  $|a| \leq 2 \cdot u(a)$

Where  $u(b)$  and  $u(a)$  are the standard uncertainties of the slope and intercept, respectively calculated as the square root of their variances. If these preconditions are not met, the candidate method may be calibrated according to point 9.7 of the Guide (refer to 7.1 Application of correction factors or terms [9.7]). The calibration shall only be applied to the full dataset.



[Point 9.5.3] The combined uncertainty of the candidates  $w_{c,CM}$  is calculated for each data set by combining the contributions from 9.5.2.1 and 9.5.2.2 according to the following equation:

$$w_{c,CM}^2(y_i) = \frac{u_{CR}^2(y_i)}{y_i^2}$$

For each dataset, the uncertainty  $w_{c,CM}$  is calculated at the level of  $y_i = 30 \mu\text{g}/\text{m}^3$  für PM<sub>2.5</sub>.

[Point 9.5.4] The expanded relative uncertainty of the results of the candidates is calculated for each data set by multiplication of  $w_{c,CM}$  with a coverage factor  $k$  according to the following equation:

$$W_{CM} = k \cdot w_{c,CM}$$

In practice:  $k=2$  for large  $n$

[Point 9.6] The highest resulting uncertainty  $W_{CM}$  is compared and assessed with the requirements on data quality of ambient air measurements according to EU Standard [7].

Two results are possible:

1.  $W_{CM} \leq W_{d,qo}$  → Candidate method is accepted as equivalent to the standard method.
2.  $W_{CM} > W_{d,qo}$  → Candidate method is not accepted as equivalent to the standard method.

The specified expanded relative uncertainty  $W_{d,qo}$  for particulate matter is 25 % [7].

## 7.5 Assessment

The determined uncertainties  $W_{CM}$  are below the specified expanded relative uncertainty  $W_{d,qo}$  of 25 % (particulate matter) for all data sets without the usage of corrective factors.

Minimum requirement fulfilled? yes

The following Table 32 shows an overview on all results of the equivalence test for the candidate BAM-1020 for PM<sub>2.5</sub>. The text within the cells is shaded green or red if it passes or fails key criteria. In this example, cells are also shaded corresponding to which of the 5 criteria they relate to in the list of the requirements of the July 2009 version of The Guidance highlighted in point 7.1 Equivalence Methodology above.

Table 32: Overview on equivalence test BAM-1020 for PM<sub>2.5</sub>

| PM <sub>2.5</sub> Smart Heated<br>BAM | 33.1% > 17 µg m <sup>-3</sup> | Orthogonal Regression |                |                              |                                  | Between Instrument Uncertainties |           |
|---------------------------------------|-------------------------------|-----------------------|----------------|------------------------------|----------------------------------|----------------------------------|-----------|
|                                       | W <sub>CM</sub> / %           | n <sub>c-s</sub>      | r <sup>2</sup> | Slope (b) +/- u <sub>b</sub> | Intercept (a) +/- u <sub>a</sub> | Reference                        | Candidate |
| All Data                              | 12.6                          | 248                   | 0.967          | 1.000 +/- 0.012              | 0.764 +/- 0.204                  | 0.33                             | 1.38      |
| < 18 µg m <sup>-3</sup>               | 9.8                           | 174                   | 0.889          | 0.971 +/- 0.025              | 1.066 +/- 0.267                  | 0.34                             | 1.05      |
| > 18 µg m <sup>-3</sup>               | 15.9                          | 74                    | 0.926          | 1.031 +/- 0.033              | -0.068 +/- 0.919                 | 0.30                             | 1.57      |







  

| SN 17010            | Dataset                 | Orthogonal Regression |                |                              |                                  | Limit Value of 30 µg m <sup>-3</sup> |                           |
|---------------------|-------------------------|-----------------------|----------------|------------------------------|----------------------------------|--------------------------------------|---------------------------|
|                     |                         | n <sub>c-s</sub>      | r <sup>2</sup> | Slope (b) +/- u <sub>b</sub> | Intercept (a) +/- u <sub>a</sub> | W <sub>CM</sub> / %                  | % > 17 µg m <sup>-3</sup> |
| Individual Datasets | Teddington Summer       | 78                    | 0.931          | 0.994 +/- 0.030              | 1.822 +/- 0.372                  | 17.11                                | 19.2                      |
|                     | Cologne Winter          | 75                    | 0.957          | 0.980 +/- 0.024              | 0.960 +/- 0.512                  | 12.79                                | 56.0                      |
|                     | Bornheim Summer         | 53                    | 0.941          | 1.052 +/- 0.036              | -0.962 +/- 0.527                 | 11.61                                | 20.8                      |
|                     | Teddington Winter       | 45                    | 0.991          | 0.970 +/- 0.014              | -0.182 +/- 0.300                 | 10.28                                | 35.6                      |
| Combined Datasets   | < 18 µg m <sup>-3</sup> | 175                   | 0.849          | 0.955 +/- 0.028              | 1.137 +/- 0.306                  | 11.46                                | 4.6                       |
|                     | > 18 µg m <sup>-3</sup> | 76                    | 0.907          | 0.984 +/- 0.035              | 0.584 +/- 0.975                  | 16.02                                | 100.0                     |
|                     | All Data                | 251                   | 0.957          | 0.969 +/- 0.013              | 0.989 +/- 0.226                  | 12.90                                | 33.5                      |

| SN 17011            | Dataset                 | Orthogonal Regression |                |                              |                                  | Limit Value of 30 µg m <sup>-3</sup> |                           |
|---------------------|-------------------------|-----------------------|----------------|------------------------------|----------------------------------|--------------------------------------|---------------------------|
|                     |                         | n <sub>c-s</sub>      | r <sup>2</sup> | Slope (b) +/- u <sub>b</sub> | Intercept (a) +/- u <sub>a</sub> | W <sub>CM</sub> / %                  | % > 17 µg m <sup>-3</sup> |
| Individual Datasets | Teddington Summer       | 78                    | 0.955          | 1.016 +/- 0.025              | 1.018 +/- 0.308                  | 14.66                                | 19.2                      |
|                     | Cologne Winter          | 75                    | 0.977          | 1.061 +/- 0.019              | 0.430 +/- 0.405                  | 17.91                                | 56.0                      |
|                     | Bornheim Summer         | 57                    | 0.901          | 1.134 +/- 0.048              | -1.498 +/- 0.727                 | 23.91                                | 21.1                      |
|                     | Teddington Winter       | 43                    | 0.992          | 0.991 +/- 0.014              | 0.630 +/- 0.293                  | 7.41                                 | 32.6                      |
| Combined Datasets   | < 18 µg m <sup>-3</sup> | 178                   | 0.881          | 1.021 +/- 0.026              | 0.634 +/- 0.286                  | 13.44                                | 4.5                       |
|                     | > 18 µg m <sup>-3</sup> | 75                    | 0.929          | 1.092 +/- 0.034              | -1.108 +/- 0.952                 | 19.03                                | 100.0                     |
|                     | All Data                | 253                   | 0.966          | 1.041 +/- 0.012              | 0.377 +/- 0.214                  | 16.28                                | 32.8                      |

| KEY   |             |
|---|-------------|
|  | Criterion 1 |
|  | Criterion 2 |
|  | Criterion 3 |
|  | Criterion 4 |
|  | Criterion 5 |
|  | Other       |

When following the 5 criteria detailed in the methodology in point 7.1 Equivalence Methodology in turn, there is the following:

- Criterion 1) Greater than 20 % of the data are greater than 17 µg/m<sup>3</sup>.
- Criterion 2) The intra instrument uncertainty of the candidate is less than 2.5 µg/m<sup>3</sup>.
- Criterion 3) The intra instrument uncertainty of the candidate is less than 2.0 µg/m<sup>3</sup>.
- Criterion 4) All of the expanded uncertainties are below 25 %.
- Criterion 5) The intercept and slope of the 'All Data' comparison for 17010 are both significant. The slope of the 'All Data' comparison for 17011 is significant.

The July 2009 version of The Guidance is ambiguous with respect to which slope and intercept should be used to correct a candidate should it fail the test for equivalence. After communication with the convenor of the EC working group, which is responsible for setting up the Guide, it was decided that the requirement of the November 2005 version of the Guide are still valid, and that the slope and intercept from the orthogonal regression of all the paired data should be used. These are shaded gold and marked 'other' in the key on the above Table 32.

The 2006 UK Equivalence Report [8] highlighted that this was a flaw in the mathematics required for equivalence as per the November 2005 version of The Guidance as it penalised instruments that were more accurate (Appendix E Section 4.2 therein). This same flaw is copied in the July 2009 version. It is the opinion of TÜV Rheinland and their UK partners that the BAM 1020 for PM<sub>2.5</sub> is indeed being penalised by the mathematics for being accurate. It is proposed that the same pragmatic approach is taken here that was previously undertaken in earlier studies. Namely: as some of the individual data set slopes are greater than 1, and some are less, there should be no need to correct the data for this slope offset.

In this particular case, the slope of all the paired data for all sites together is 1.000; therefore it is not possible to correct for slope.

The intercept of all the paired data for all sites together is 0.764. Therefore there is an additional evaluation by application of the respective calibration term onto the datasets in chapter 7.1 Application of correction factors or terms [9.7]

The revised July 2009 version of the guide requires that when operating in networks, a candidate method needs to be tested annually at a number of sites and that the number of the instruments to be tested is dependent on the expanded measurement uncertainty of the device. The respective realization is the responsibility of the network operator or of the responsible authority of the member state. However TÜV Rheinland and their UK partners recommend, that the expanded uncertainty for the full data set is referred to for this, namely 12.6 %, which again would require an annual test at 3 measurement sites (Guide [4], chapter 9.9.2, table 6).

## 7.6 Detailed representation of test results

Table 33 shows an overview of the in-between-instrument uncertainties  $u_{ref}$  of the reference devices during field tests. A summarized representation of the results of the equivalence test incl. the determined expanded measurement uncertainties  $W_{CM}$  from the field investigations are shown in Table 34.

**Table 33:** *In-between-instrument uncertainty  $u_{ref}$  of the reference devices, measured component PM<sub>2.5</sub>*

| Reference devices | Site               | No. of values | Uncertainty $u_{bs}$     |
|-------------------|--------------------|---------------|--------------------------|
| No                |                    |               | $\mu\text{g}/\text{m}^3$ |
| 1 / 2             | Teddington, Summer | 77            | 0.33                     |
| 1 / 2             | Cologne, Winter    | 75            | 0.39                     |
| 1 / 2             | Bornheim, Summer   | 53            | 0.30                     |
| 1 / 2             | Teddington, Winter | 43            | 0.27                     |
| 1 / 2             | All test sites     | 248           | 0.33                     |

The in-between-instrument uncertainty  $u_{ref}$  of the reference devices is  $< 2 \mu\text{g}/\text{m}^3$  for all sites.

**Table 34:** *Summary of the results of the equivalence test, SN 17010 & SN 17011, raw data*

| PM <sub>2.5</sub> Smart Heated BAM | 33.1% > 17 $\mu\text{g m}^{-3}$ | Orthogonal Regression |       |                     | Between Instrument Uncertainties |           |           |
|------------------------------------|---------------------------------|-----------------------|-------|---------------------|----------------------------------|-----------|-----------|
|                                    | $W_{CM} / \%$                   | $n_{c-s}$             | $r^2$ | Slope (b) +/- $u_b$ | Intercept (a) +/- $u_a$          | Reference | Candidate |
| All Data                           | 12.6                            | 248                   | 0.967 | 1.000 +/- 0.012     | 0.764 +/- 0.204                  | 0.33      | 1.38      |
| < 18 $\mu\text{g m}^{-3}$          | 9.8                             | 174                   | 0.889 | 0.971 +/- 0.025     | 1.066 +/- 0.267                  | 0.34      | 1.05      |
| > 18 $\mu\text{g m}^{-3}$          | 15.9                            | 74                    | 0.926 | 1.031 +/- 0.033     | -0.068 +/- 0.919                 | 0.30      | 1.57      |

| SN 17010            | Dataset                   | Orthogonal Regression |       |                     | Limit Value of 30 $\mu\text{g m}^{-3}$ |               |                             |
|---------------------|---------------------------|-----------------------|-------|---------------------|--|---------------|-----------------------------|
|                     |                           | $n_{c-s}$             | $r^2$ | Slope (b) +/- $u_b$ | Intercept (a) +/- $u_a$                | $W_{CM} / \%$ | % > 17 $\mu\text{g m}^{-3}$ |
| Individual Datasets | Teddington Summer         | 78                    | 0.931 | 0.994 +/- 0.030     | 1.822 +/- 0.372                        | 17.11         | 19.2                        |
|                     | Cologne Winter            | 75                    | 0.957 | 0.980 +/- 0.024     | 0.960 +/- 0.512                        | 12.79         | 56.0                        |
|                     | Bornheim Summer           | 53                    | 0.941 | 1.052 +/- 0.036     | -0.962 +/- 0.527                       | 11.61         | 20.8                        |
|                     | Teddington Winter         | 45                    | 0.991 | 0.970 +/- 0.014     | -0.182 +/- 0.300                       | 10.28         | 35.6                        |
| Combined Datasets   | < 18 $\mu\text{g m}^{-3}$ | 175                   | 0.849 | 0.955 +/- 0.028     | 1.137 +/- 0.306                        | 11.46         | 4.6                         |
|                     | > 18 $\mu\text{g m}^{-3}$ | 76                    | 0.907 | 0.984 +/- 0.035     | 0.584 +/- 0.975                        | 16.02         | 100.0                       |
|                     | All Data                  | 251                   | 0.957 | 0.969 +/- 0.013     | 0.989 +/- 0.226                        | 12.90         | 33.5                        |

| SN 17011            | Dataset                   | Orthogonal Regression |       |                     | Limit Value of 30 $\mu\text{g m}^{-3}$ |               |                             |
|---------------------|---------------------------|-----------------------|-------|---------------------|--|---------------|-----------------------------|
|                     |                           | $n_{c-s}$             | $r^2$ | Slope (b) +/- $u_b$ | Intercept (a) +/- $u_a$                | $W_{CM} / \%$ | % > 17 $\mu\text{g m}^{-3}$ |
| Individual Datasets | Teddington Summer         | 78                    | 0.955 | 1.016 +/- 0.025     | 1.018 +/- 0.308                        | 14.66         | 19.2                        |
|                     | Cologne Winter            | 75                    | 0.977 | 1.061 +/- 0.019     | 0.430 +/- 0.405                        | 17.91         | 56.0                        |
|                     | Bornheim Summer           | 57                    | 0.901 | 1.134 +/- 0.048     | -1.498 +/- 0.727                       | 23.91         | 21.1                        |
|                     | Teddington Winter         | 43                    | 0.992 | 0.991 +/- 0.014     | 0.630 +/- 0.293                        | 7.41          | 32.6                        |
| Combined Datasets   | < 18 $\mu\text{g m}^{-3}$ | 178                   | 0.881 | 1.021 +/- 0.026     | 0.634 +/- 0.286                        | 13.44         | 4.5                         |
|                     | > 18 $\mu\text{g m}^{-3}$ | 75                    | 0.929 | 1.092 +/- 0.034     | -1.108 +/- 0.952                       | 19.03         | 100.0                       |
|                     | All Data                  | 253                   | 0.966 | 1.041 +/- 0.012     | 0.377 +/- 0.214                        | 16.28         | 32.8                        |

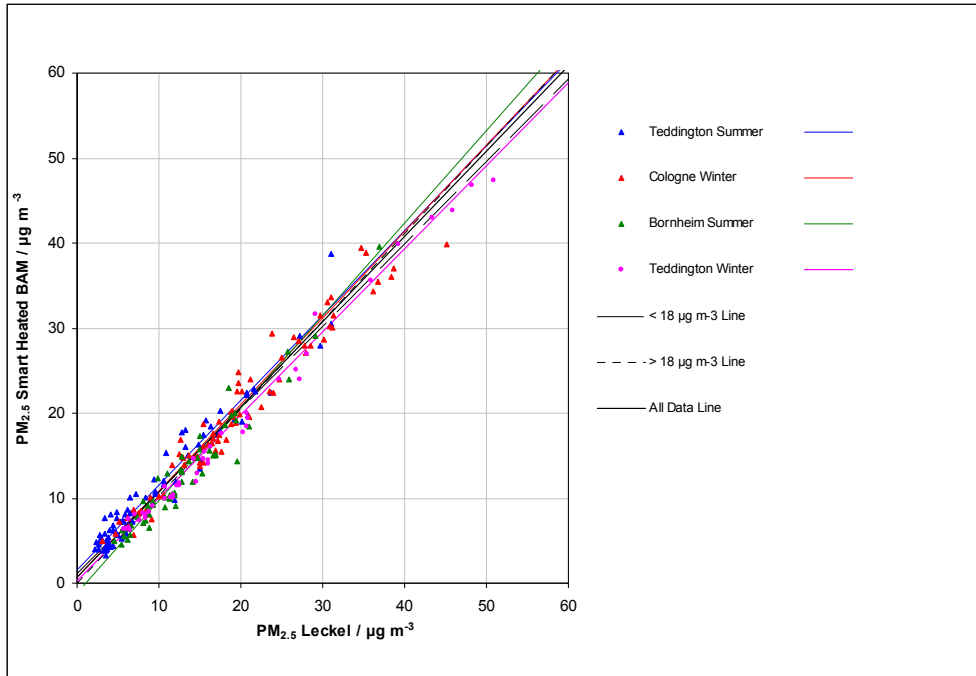

Figure 51: Reference vs. candidate, SN 17010 & SN 17011, all test sites

Report on the suitability test of the ambient air quality measurement system BAM-1020 with PM2.5 pre-separator of the company Met One Instruments, Inc. for the component suspended particulate matter PM2.5, Report No.: 936/21209919/A

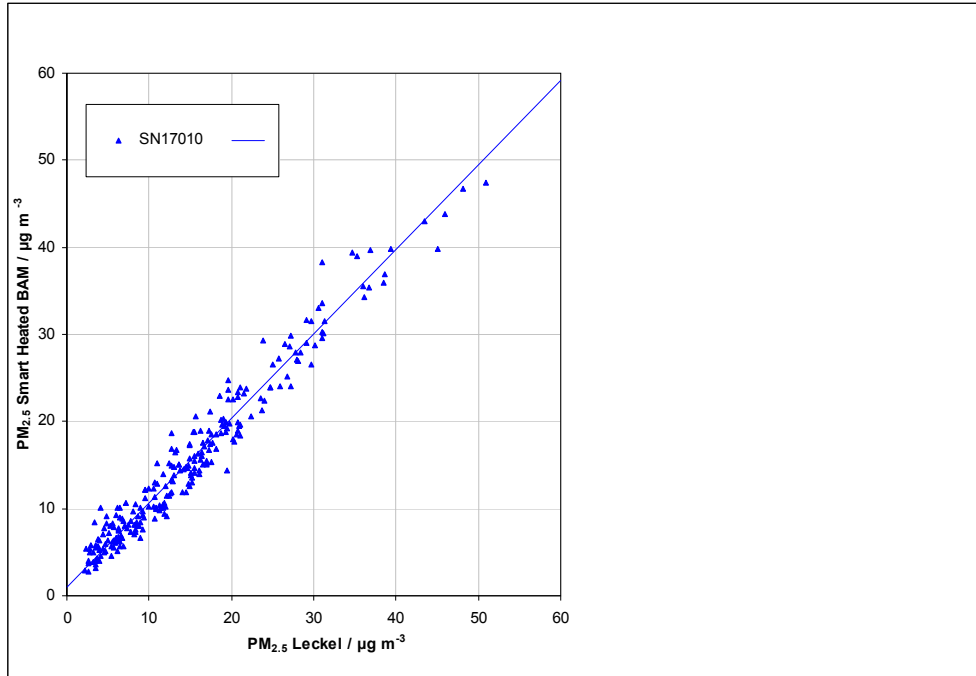

Figure 52: Reference vs. candidate, SN 17010, all test sites

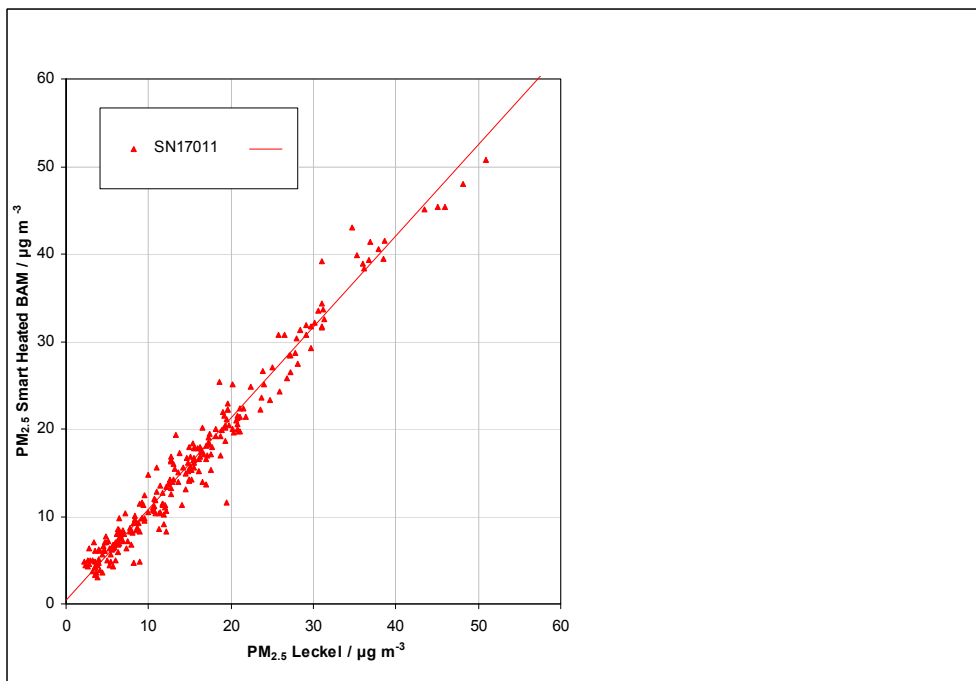

Figure 53: Reference vs. candidate, SN 17011, all test sites

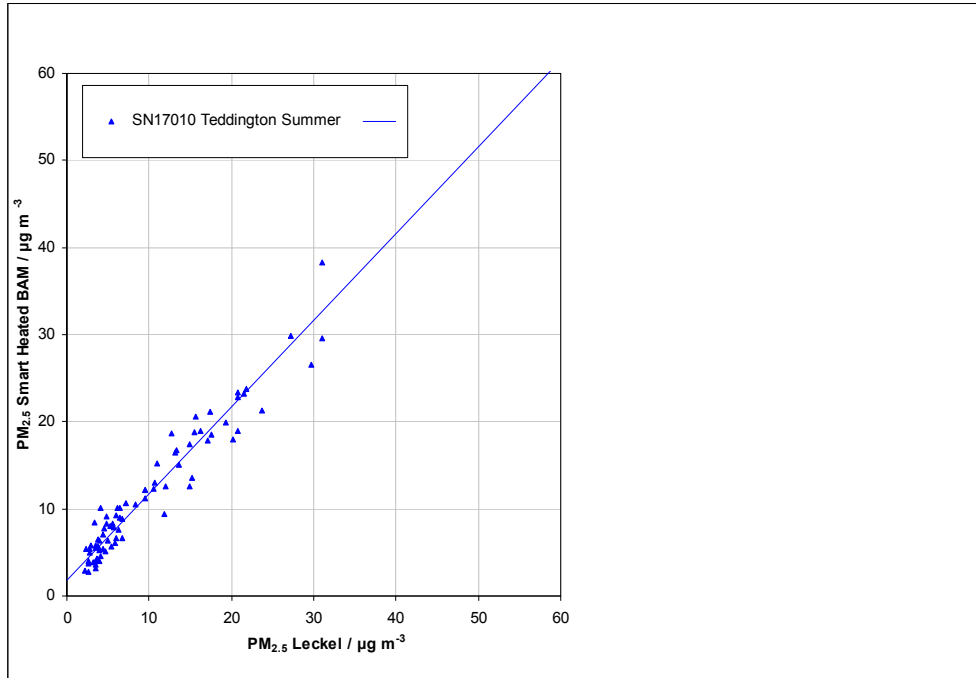

Figure 54: Reference vs. candidate, SN 17010, Teddington, Summer

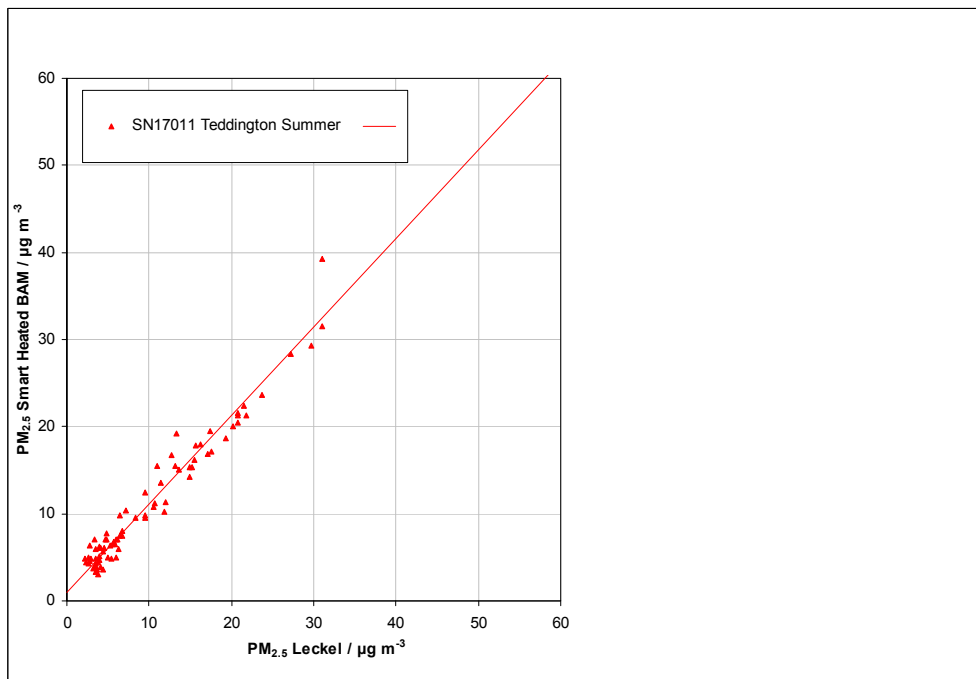

Figure 55: Reference vs. candidate, SN 17011, Teddington, Summer

Report on the suitability test of the ambient air quality measurement system BAM-1020 with PM2.5 pre-separator of the company Met One Instruments, Inc. for the component suspended particulate matter PM2.5, Report No.: 936/21209919/A

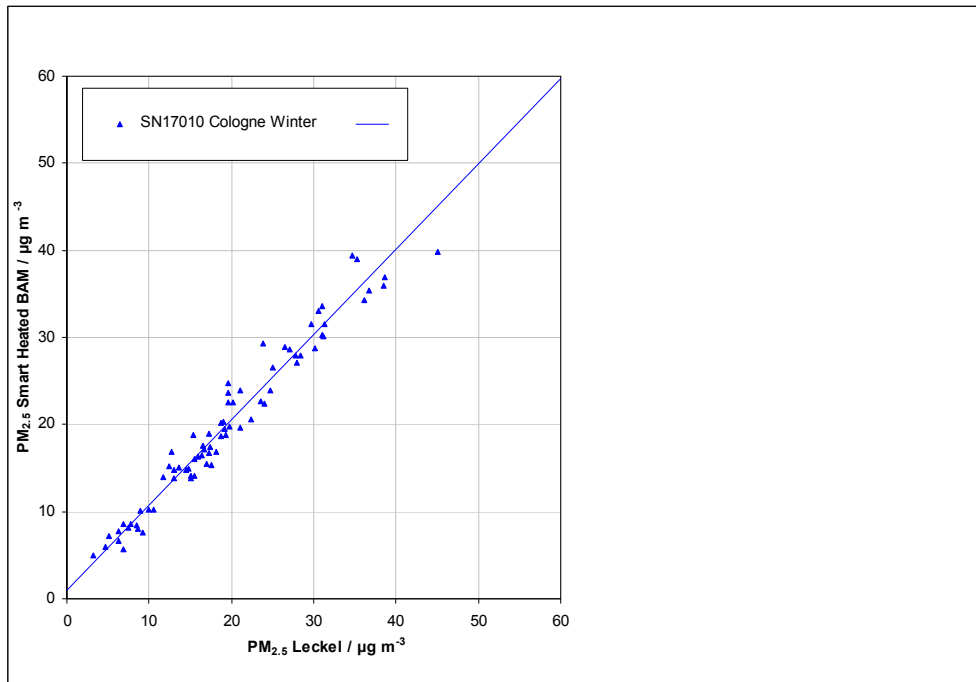

Figure 56: Reference vs. candidate, SN 17010, Cologne, Winter

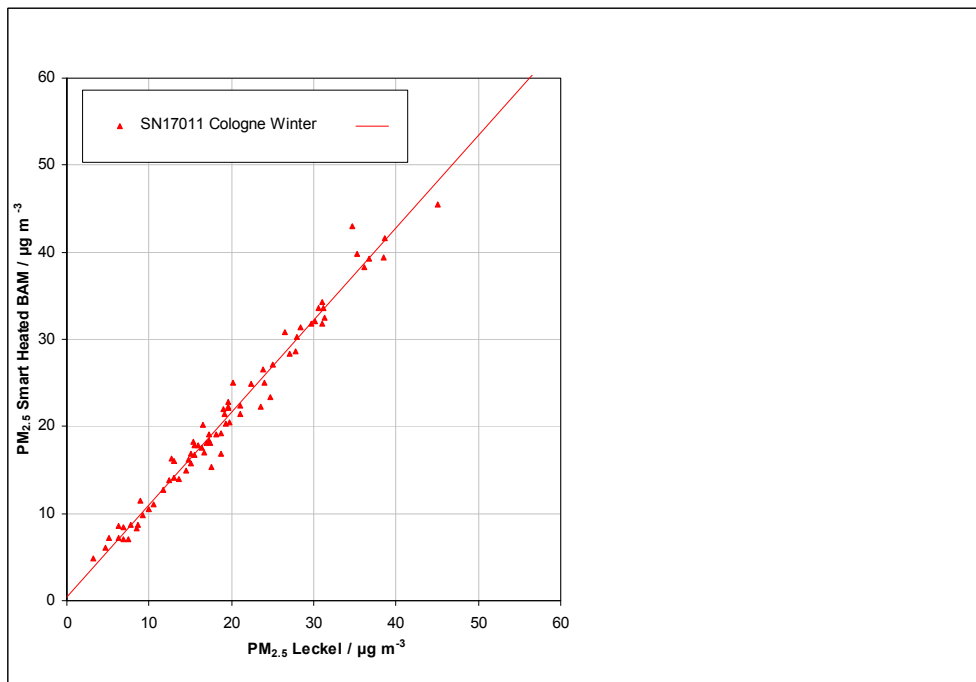

Figure 57: Reference vs. candidate, SN 17011, Cologne, Winter



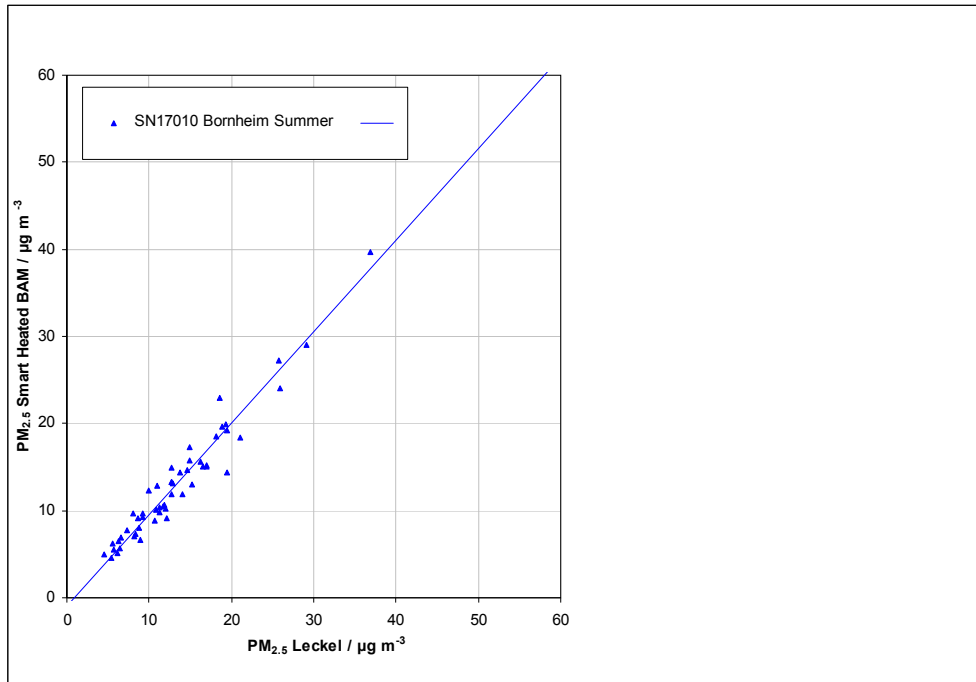

Figure 58: Reference vs. candidate, SN 17010, Bornheim, Summer

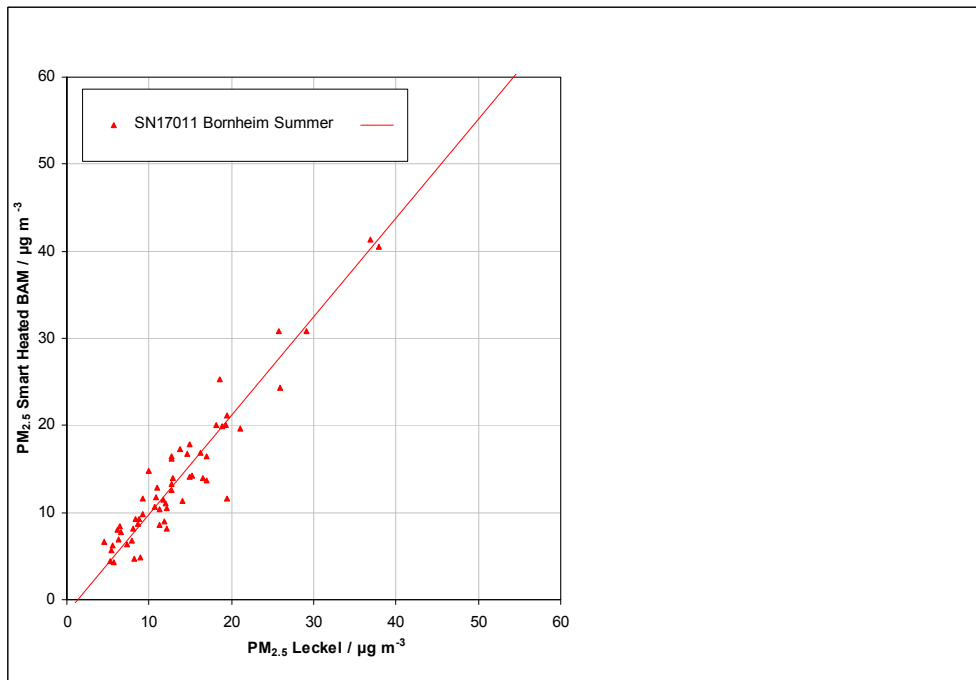

Figure 59: Reference vs. candidate, SN 17011, Bornheim, Summer

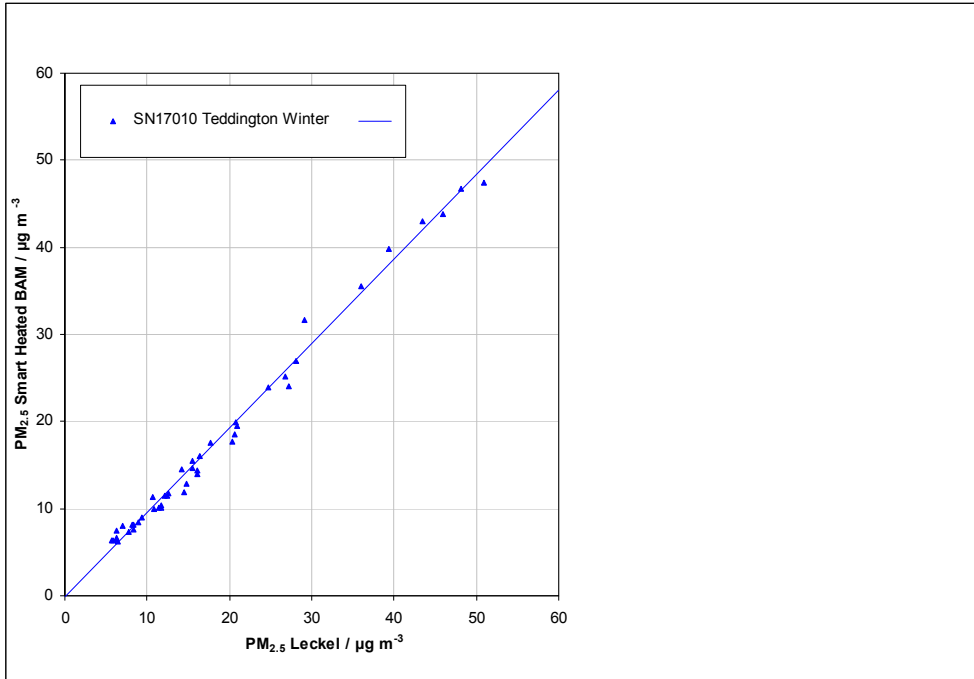

Figure 60: Reference vs. candidate, SN 17010, Teddington, Winter

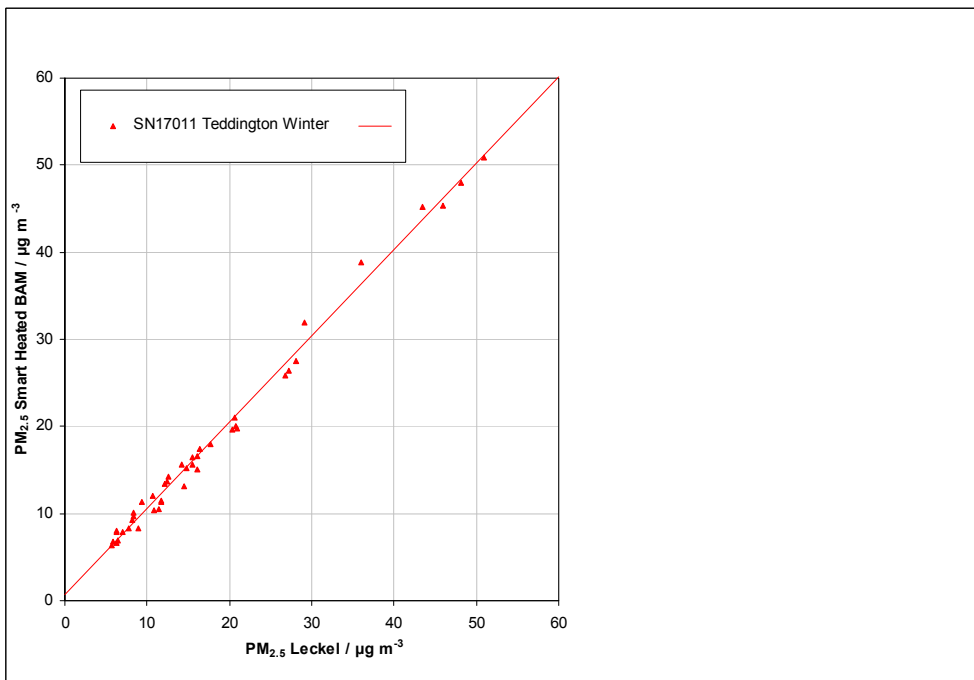

Figure 61: Reference vs. candidate, SN 17011, Teddington, Winter

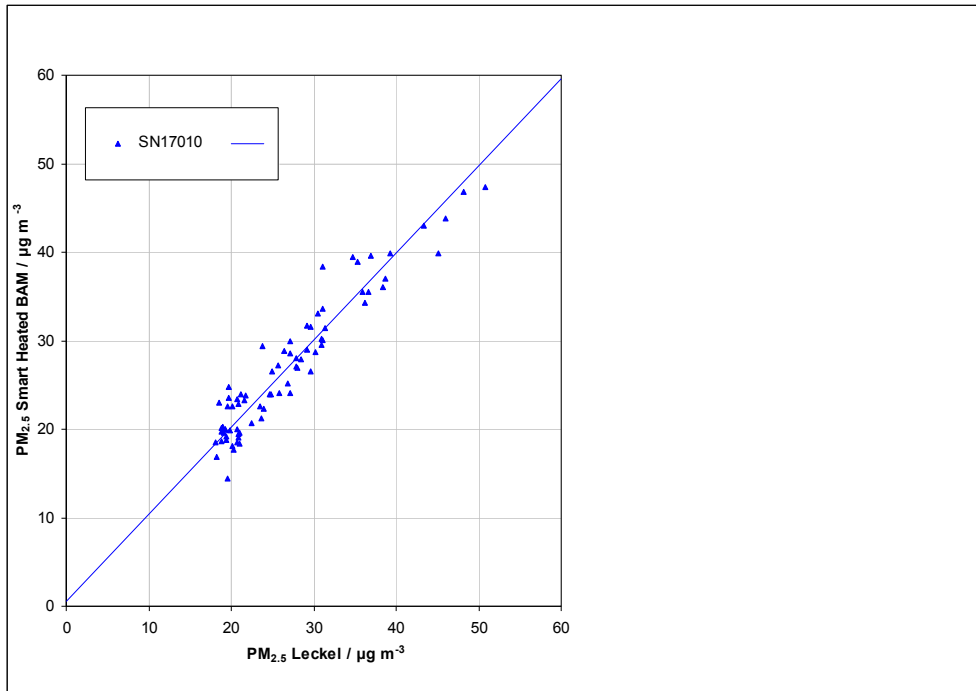

Figure 62: Reference vs. candidate, SN 17010, values  $\geq 18 \mu\text{g}/\text{m}^3$

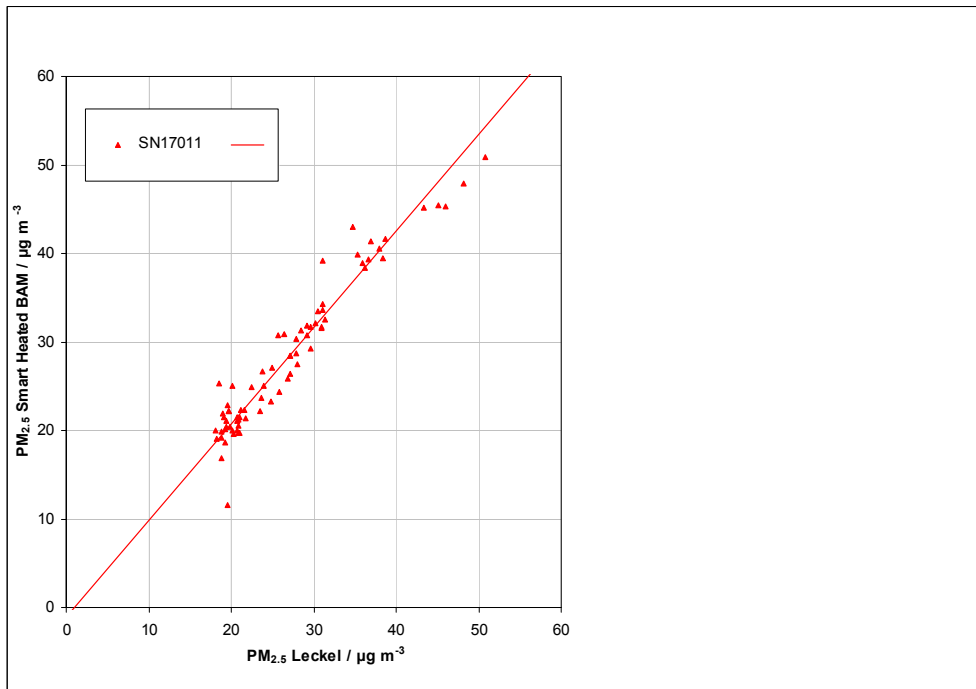

Figure 63: Reference vs. candidate, SN 17011, values  $\geq 18 \mu\text{g}/\text{m}^3$

## 7.1 Application of correction factors or terms [9.7]

*If the highest resulting expanded uncertainty of the candidate method is larger than the expanded relative uncertainty, which is defined in the requirements on the data quality of ambient air measurements according to EU-Guideline [7], the application of correction factors or terms is permitted. The corrected values have to fulfil the requirements according to point 9.5.2.2 et seqq. of the Guide „Demonstration of Equivalence of Ambient Air Monitoring Methods“.*

## 7.2 Equipment

Not required for this minimum requirement.

## 7.3 Carrying out the test

Refer to Module 9.5.2.2 – 9.5.6.

## 7.4 Evaluation

If evaluation of the raw data according to module 9.5.2.2 – 9.5.6 leads to a case  $W_{CM} > W_{dqo}$ , which means that the candidate systems is not regarded equivalent to the reference method, it is permitted to apply a correction factor or –term resulting from the regression equation obtained from the full data set. The corrected values shall satisfy the requirements for all data sets or subsets (refer to module 9.5.2.2 – 9.5.6).

Moreover, a correction factor may be applied even for  $W_{CM} \leq W_{dqo}$  in order to improve the accuracy of the candidate systems.

Three distinct situations may arise:

- a) Slope b not significantly different from 1:  $|b - 1| \leq 2u(b)$ ,  
Intercept a significantly different from 0:  $|a| > 2u(a)$
- b) Slope b significantly different from 1:  $|b - 1| > 2u(b)$ ,  
Intercept a not significantly different from 0:  $|a| \leq 2u(a)$
- c) Slope b significantly different from 1:  $|b - 1| > 2u(b)$   
Intercept a significantly different from 0:  $|a| > 2u(a)$

Re a)

The value of the intercept a may be used as a correction term to correct all input values  $y_i$  according to the following equation.

$$y_{i,corr} = y_i - a$$

The resulting values of  $y_{i,\text{corr}}$  may then be used to calculate the following new terms by linear regression:

$$y_{i,\text{corr}} = c + dx_i$$

and

$$u_{c\_s}^2(y_{i,\text{corr}}) = \frac{\text{RSS}}{(n-2)} - u^2(x_i) + [c + (d-1)x_i]^2 + u^2(a)$$

with  $u(a)$  = uncertainty of the original intercept  $a$ , the value of which has been used to obtain  $y_{i,\text{corr}}$ .

Algorithms for the calculation of intercepts as well as slopes and their variances by orthogonal regression are described in detail in annex B of [6]. RSS is determined analogue to the calculation in module 9.5.2.2 – 9.5.6.

Re b)

The value of the slope  $b$  may be used as a factor to correct all input values  $y_i$  according to the following equation.

$$y_{i,\text{corr}} = \frac{y_i}{b}$$

The resulting values of  $y_{i,\text{corr}}$  may then be used to calculate the following new terms by linear regression:

$$y_{i,\text{corr}} = c + dx_i$$

and

$$u_{c\_s}^2(y_{i,\text{corr}}) = \frac{\text{RSS}}{(n-2)} - u^2(x_i) + [c + (d-1)x_i]^2 + x_i^2 u^2(b)$$

with  $u(b)$  = uncertainty of the original slope  $b$ , the value of which has been used to obtain  $y_{i,\text{corr}}$ .

Algorithms for the calculation of intercepts as well as slopes and their variances by orthogonal regression are described in detail in annex B of [4]. RSS is determined analogue to the calculation in module 9.5.2.2 – 9.5.6.

Re c)

The values of the slope  $b$  and of the intercept  $a$  may be used as correction terms to correct all input values  $y_i$  according to the following equation.

$$y_{i,\text{corr}} = \frac{y_i - a}{b}$$

The resulting values of  $y_{i,corr}$  may then be used to calculate the following new terms by linear regression:

$$y_{i,corr} = c + dx_i$$

and

$$u_{c-s}^2(y_{i,corr}) = \frac{RSS}{(n-2)} - u^2(x_i) + [c + (d-1)x_i]^2 + x_i^2 u^2(b) + u^2(a)$$

with  $u(b)$  = uncertainty of the original slope  $b$ , the value of which has been used to obtain  $y_{i,corr}$  and with  $u(a)$  = uncertainty of the original intercept  $a$ , the value of which has been used to obtain  $y_{i,corr}$ .

Algorithms for the calculation of intercepts as well as slopes and their variances by orthogonal regression are described in detail in annex B of [4]. RSS is determined analogue to the calculation in module 9.5.2.2 – 9.5.6.

The values for  $u_{c-s,corr}$  are used for the calculation of the combined relative uncertainty of the candidate systems after correction according to the following equation:

$$w_{c,CM,corr}^2(y_i) = \frac{u_{c-s,corr}^2(y_i)}{y_i^2}$$

For the corrected data set, uncertainty is calculated at the daily limit value  $w_{c,CM,corr}$  by taking as  $y_i$  the concentration at the limit value.

The expanded relative uncertainty  $W_{CM,corr}$  is calculated according to the following equation:

$$W_{CM,corr} = k \cdot w_{CM,corr}$$

In practice:  $k=2$  for large  $n$

The highest resulting uncertainty  $W_{CM}$  is compared and assessed with the requirements on data quality of ambient air measurements according to EU Standard [7].

Two results are possible:

1.  $W_{CM} \leq W_{dgo}$  → Candidate method is accepted as equivalent to the standard method.
2.  $W_{CM} > W_{dgo}$  → Candidate method is not accepted as equivalent to the standard method.

The specified expanded relative uncertainty  $W_{dgo}$  for particulate matter is 25 % [7]

## 7.5 Assessment

The candidate systems fulfil the requirements on the data quality of ambient air quality measurements during the test already without application of correction factors.

Minimum requirement fulfilled? yes

However, the evaluation of the full data set for both candidates leads to a significant intercept (refer to Table 34). The intercept for the full dataset is 0.764. For this reason an intercept correction has been applied on the full dataset and all datasets have been evaluated again with the corrected values. Also after the correction, all datasets fulfil the requirements on the data quality and the improvement in the expanded measurement uncertainties is only marginal, though in some cases there is even a slight increase (e.g. Teddington (Winter) for 17010).

The July 2009 version of The Guidance requires that when operating in networks, a candidate method needs to be tested annually at a number of sites corresponding to the highest expanded uncertainty found during equivalence testing. These criteria are banded in 5 % steps (Guide [4], point 9.9.2, table 6). Importantly the highest expanded uncertainty both before and after correction for intercept is SN 17011 for Bornheim Summer which in both cases lies between 20 and 25 %.

Therefore the application of a correction factor for the BAM-1020 for PM<sub>2.5</sub> is slightly improving the expanded measurement uncertainties but leads to no significant advantage. The proof for equivalence of the candidate BAM-1020 for PM<sub>2.5</sub> can also be demonstrated without the application of correction factors or terms.

The respective realization of the above mentioned requirement on ongoing QA/QC in networks is the responsibility of the network operator or of the responsible authority of the member state. However TÜV Rheinland and their UK partners recommend, that the expanded uncertainty for the full data set is referred to for this, namely 12.6 % (uncorrected dataset) respectively 11.6 % (dataset after offset-correction), which again would require an annual test at 3 measurement sites.

## 7.6 Detailed representation of test results

Table 35 shows the results of evaluations for the equivalence test after application of a correction factor for the intercept onto the full dataset.

*Table 35: Summary of the results of the equivalence test, SN 17010 & SN 17011, after intercept correction*

| PM <sub>2.5</sub> Smart Heated<br>BAM Corrected by<br>subtracting 0.764 | 33.1% > 17 µg m <sup>-3</sup> | Orthogonal Regression |                |                              |                                      | Between Instrument Uncertainties |                           |
|---|-------------------------------|-----------------------|----------------|------------------------------|--------------------------------------|----------------------------------|---------------------------|
|   | W <sub>CM</sub> / %           | n <sub>c-s</sub>      | r <sup>2</sup> | Slope (b) +/- u <sub>b</sub> | Intercept (a) +/- u <sub>a</sub>     | Reference                        | Candidate                 |
| All Data  | 11.6                          | 248                   | 0.967          | 1.000 +/- 0.012              | 0.000 +/- 0.204                      | 0.33                             | 1.38                      |
| < 18 µg m <sup>-3</sup>   | 10.5                          | 174                   | 0.889          | 0.971 +/- 0.025              | 0.302 +/- 0.267                      | 0.34                             | 1.05                      |
| > 18 µg m <sup>-3</sup>   | 14.9                          | 74                    | 0.926          | 1.031 +/- 0.033              | -0.832 +/- 0.919                     | 0.30                             | 1.57                      |
| SN 17010  | Dataset                       | Orthogonal Regression |                |                              | Limit Value of 30 µg m <sup>-3</sup> |                                  |                           |
|   |                               | n <sub>c-s</sub>      | r <sup>2</sup> | Slope (b) +/- u <sub>b</sub> | Intercept (a) +/- u <sub>a</sub>     | W <sub>CM</sub> / %              | % > 17 µg m <sup>-3</sup> |
| Individual Datasets   | Teddington Summer             | 78                    | 0.931          | 0.994 +/- 0.030              | 1.058 +/- 0.372                      | 14.46                            | 19.2                      |
|   | Cologne Winter                | 75                    | 0.957          | 0.980 +/- 0.024              | 0.196 +/- 0.512                      | 12.96                            | 56.0                      |
|   | Bornheim Summer               | 53                    | 0.941          | 1.052 +/- 0.036              | -1.726 +/- 0.527                     | 11.08                            | 20.8                      |
|   | Teddington Winter             | 45                    | 0.991          | 0.970 +/- 0.014              | -0.946 +/- 0.300                     | 14.40                            | 35.6                      |
| Combined Datasets   | < 18 µg m <sup>-3</sup>       | 175                   | 0.849          | 0.955 +/- 0.028              | 0.373 +/- 0.306                      | 13.21                            | 4.6                       |
|   | > 18 µg m <sup>-3</sup>       | 76                    | 0.907          | 0.984 +/- 0.035              | -0.180 +/- 0.975                     | 16.67                            | 100.0                     |
|   | Alle Standorte                | 251                   | 0.957          | 0.969 +/- 0.013              | 0.225 +/- 0.226                      | 13.78                            | 33.5                      |
| SN 17011  | Dataset                       | Orthogonal Regression |                |                              | Limit Value of 30 µg m <sup>-3</sup> |                                  |                           |
|   |                               | n <sub>c-s</sub>      | r <sup>2</sup> | Slope (b) +/- u <sub>b</sub> | Intercept (a) +/- u <sub>a</sub>     | W <sub>CM</sub> / %              | % > 17 µg m <sup>-3</sup> |
| Individual Datasets   | Teddington Summer             | 78                    | 0.955          | 1.016 +/- 0.025              | 0.254 +/- 0.308                      | 11.85                            | 19.2                      |
|   | Cologne Winter                | 75                    | 0.977          | 1.061 +/- 0.019              | -0.334 +/- 0.405                     | 14.00                            | 56.0                      |
|   | Bornheim Summer               | 57                    | 0.901          | 1.134 +/- 0.048              | -2.262 +/- 0.727                     | 20.72                            | 21.1                      |
|   | Teddington Winter             | 43                    | 0.992          | 0.991 +/- 0.014              | -0.134 +/- 0.293                     | 7.59                             | 32.6                      |
| Combined Datasets   | < 18 µg m <sup>-3</sup>       | 178                   | 0.881          | 1.021 +/- 0.026              | -0.130 +/- 0.286                     | 11.10                            | 4.5                       |
|   | > 18 µg m <sup>-3</sup>       | 75                    | 0.929          | 1.092 +/- 0.034              | -1.872 +/- 0.952                     | 16.67                            | 100.0                     |
|   | Alle Standorte                | 253                   | 0.966          | 1.041 +/- 0.012              | -0.387 +/- 0.214                     | 13.52                            | 32.8                      |



## **8 Recommendations for practical use**

### **Works in the maintenance interval (4 weeks)**

The following work is required for the tested measuring system in a regular interval:

- Regular visual inspection / telemetric monitoring
- - Device status o.k.
- - No error messages
- - No contaminations
- Check of the instrument functions according to the instructions of the manufacturer
- Check of filter tape stock
- Maintenance of the sampling head according manufacturer's specifications
- All 4 weeks: plausibility check of temperature, pressure sensors, if necessary re-calibration
- All 4 weeks: leak check and check of the flow rate

Furthermore it is to pay attention to the advices of the manufacturer.

The measuring systems carries out by default at each measurement cycle an internal check of the zero point (zero measurement) as well as of the sensitivity (measurement with reference foil). The results of these checks can be used for the continuous check of the stability of the radiometric measurement.

### Further maintenance works

The following works are necessary in addition to the regular works in the maintenance interval:

- Replacement of filter tape after approx. 2 months (measurement cycle: 60 min). After the replacement, it is strongly advised to perform a self-test according to chapter 3.5 of the manual.
- According to the manufacturer, the calibration of the flow rate should be performed every 2 months.
- The muffler at the pump should be replaced semiannually.
- The sensors for the ambient temperature, air pressure, filter temperature and filter rH have to be checked every 6 months according to the manual.
- The flow controller, the pump and the sample heater have to be checked every 6 months according to the manual.
- Once a year, a 72 h BKGD-test with the help of the zero filter kit BX-302 according to the manual point 7.7 should be performed
- Once a year the carbon vanes of the vacuum pump (only rotary vane pump) have to be checked and replaced if necessary during an annual base maintenance.
- During the annual base maintenance, it is also to pay attention to the cleaning of the sampling tube.

Further details are provided in the user manual.

Department of Environmental Protection



---

Karsten Pletscher

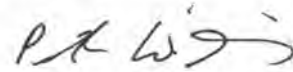

---

Dr. Peter Wilbring

Koeln, March 26, 2010  
936/21209919/A

## 9 Literature

- [1] Standard VDI 4202, Sheet 1, „Minimum requirements for suitability tests of automated ambient air quality measuring systems – Point-related measurement methods of gaseous and particulate pollutants“, June 2002
- [2] Standard VDI 4203, Sheet 3, „Testing of automated measuring systems – Test procedures for point-related ambient air quality measuring systems of gaseous and particulate pollutants“, August 2004
- [3] Standard EN 14907, „Ambient air quality - Standard gravimetric measurement method for the determination of the PM<sub>2.5</sub> mass fraction of suspended particulate matter“, German version EN 14907: 2005
- [4] Guide “Demonstration of Equivalence of Ambient Air Monitoring Methods”, English version of July 2009)
- [5] Operating manual BAM-1020, Version 9800-RevG
- [6] Operating manual LVS3, 2000
- [7] Directive 2008/50/EC of the European Parliament and of the Council of May 21<sup>st</sup> 2008 on ambient air quality and cleaner air for Europe
- [8] Report „UK Equivalence Programme for Monitoring of Particulate Matter“, Report No.: BV/AQ/AD202209/DH/2396 of June 5<sup>th</sup>, 2006

## **10 Appendix**

### **Appendix 1 Measured and calculated values**

- Annex 1: Detection limit
- Annex 2: Temperature dependency of zero point / sensitivity
- Annex 3: Dependency on supply voltage
- Annex 4: Measured values at the field test sites
- Annex 5: Ambient conditions at the field test sites
- Annex 6: Software version BAM-1020

### **Annex 2 Filter weighing procedure**

### **Appendix 3 Manuals**

**Annex 1**
**Detection limit**

| <b>Manufacturer</b> Met One Instruments |                              |  |                                    |
|---|------------------------------|--|------------------------------------|
| <b>Type</b>                             | BAM-1020                     | <b>Standards</b>                             | ZP Measured value with zero filter |
| <b>Serial-No.</b>                       | SN 17010 & SN 17011          |  |                                    |
| No.                                     | Date                         | Measured values [ $\mu\text{g}/\text{m}^3$ ] |                                    |
|   |                              | SN 17010                                     | SN 17011                           |
| 1                                       | 5/14/2009                    | -0.76  | -0.62                              |
| 2                                       | 5/15/2009                    | -1.18  | -1.45                              |
| 3                                       | 5/16/2009                    | -0.97  | -1.70                              |
| 4                                       | 5/17/2009                    | -0.01  | -1.62                              |
| 5                                       | 5/18/2009                    | -0.72  | -1.33                              |
| 6                                       | 5/19/2009                    | -0.68  | -0.45                              |
| 7                                       | 5/20/2009                    | 0.37   | -0.53                              |
| 8                                       | 5/21/2009                    | -1.72  | -1.99                              |
| 9                                       | 5/22/2009                    | -0.64  | -0.91                              |
| 10                                      | 5/23/2009                    | 0.70   | -1.45                              |
| 11                                      | 5/24/2009                    | -1.05  | -0.49                              |
| 12                                      | 5/25/2009                    | -0.80  | -0.78                              |
| 13                                      | 5/26/2009                    | -0.47  | -1.16                              |
| 14                                      | 5/27/2009                    | -0.09  | -0.53                              |
| 15                                      | 5/28/2009                    | -0.22  | -1.41                              |
|   | No. of values                | 15.00  | 15.00                              |
|   | Mean                         | -0.55  | -1.09                              |
|   | Standard deviation $s_{x_0}$ | 0.62   | 0.51                               |
|   | Detection limit $x$          | 1.33   | 1.09                               |

$$s_{x_0} = \sqrt{\left(\frac{1}{n-1}\right) \cdot \sum_{i=1,n} (x_{0i} - \bar{x}_0)^2}$$

**Annex 2 Dependence of zero point / measured value on ambient temperature**

|   |     |                  |                               |              |                               |              |                               |              |  |
|---|-----|------------------|-------------------------------|--------------|-------------------------------|--------------|-------------------------------|--------------|--|
| <b>Manufacturer</b> Met One Instruments   |     |                  |                               |              |                               |              |                               |              |  |
| <b>Type</b> BAM-1020  |     |                  |                               |              |                               |              |                               |              |  |
| <b>Serial-No.</b> SN 17010 & SN 17011   |     |                  |                               |              |                               |              |                               |              |  |
| <b>Standards</b> ZP Measured value with zero filter<br>RP built-in reference foil |     |                  |                               |              |                               |              |                               |              |  |
|   |     |                  | Cycle 1                       |              | Cycle 2                       |              | Cycle 3                       |              |  |
| SN 17010  | No. | Temperature [°C] | Measured value MetOne [µg/m³] | Dev. [µg/m³] | Measured value MetOne [µg/m³] | Abw. [µg/m³] | Measured value MetOne [µg/m³] | Dev. [µg/m³] |  |
| ZP  | 1   | 20               | 1.4                           | -            | 0.1                           | -            | 2.4                           | -            |  |
|   | 2   | 5                | 1.6                           | 0.2          | 1.7                           | 1.6          | 1.5                           | -0.9         |  |
|   | 3   | 20               | -1.0                          | -2.4         | 0.7                           | 0.7          | 0.7                           | -1.7         |  |
|   | 4   | 40               | -1.3                          | -2.8         | 2.1                           | 2.0          | 0.2                           | -2.3         |  |
|   | 5   | 20               | 0.1                           | -1.4         | 1.1                           | 1.0          | 4.5                           | 2.1          |  |
| SN 17011  | No. | Temperature [°C] | Measured value MetOne [µg/m³] | Dev. [µg/m³] | Measured value MetOne [µg/m³] | Abw. [µg/m³] | Measured value MetOne [µg/m³] | Dev. [µg/m³] |  |
| ZP  | 1   | 20               | -0.7                          | -            | -1.6                          | -            | -1.7                          | -            |  |
|   | 2   | 5                | -0.4                          | 0.3          | -0.5                          | 1.0          | -0.1                          | 1.6          |  |
|   | 3   | 20               | -0.7                          | 0.0          | -1.0                          | 0.5          | -1.0                          | 0.6          |  |
|   | 4   | 40               | -2.5                          | -1.8         | -3.0                          | -1.4         | -3.2                          | -1.5         |  |
|   | 5   | 20               | -1.6                          | -0.9         | -0.7                          | 0.9          | -1.2                          | 0.4          |  |
| SN 17010  | No. | Temperature [°C] | Measured value foil [µg/cm²]  | Dev. [%]     | Measured value foil [µg/cm²]  | Dev. [%]     | Measured value foil [µg/cm²]  | Dev. [%]     |  |
| RP  | 1   | 20               | 829.8                         | -            | 829.6                         | -            | 829.3                         | -            |  |
|   | 2   | 5                | 829.4                         | 0.0          | 829.3                         | 0.0          | 829.3                         | 0.0          |  |
|   | 3   | 20               | 829.7                         | 0.0          | 829.7                         | 0.0          | 829.6                         | 0.0          |  |
|   | 4   | 40               | 830.8                         | 0.1          | 830.7                         | 0.1          | 831.8                         | 0.3          |  |
|   | 5   | 20               | 829.6                         | 0.0          | 829.3                         | 0.0          | 829.6                         | 0.0          |  |
| SN 17011  | No. | Temperature [°C] | Measured value foil [µg/cm²]  | Dev. [%]     | Measured value foil [µg/cm²]  | Dev. [%]     | Measured value foil [µg/cm²]  | Dev. [%]     |  |
| RP  | 1   | 20               | 822.9                         | -            | 821.9                         | -            | 823.3                         | -            |  |
|   | 2   | 5                | 821.8                         | -0.1         | 822.4                         | 0.1          | 823.3                         | 0.0          |  |
|   | 3   | 20               | 822.6                         | 0.0          | 823.3                         | 0.2          | 823.7                         | 0.0          |  |
|   | 4   | 40               | 823.8                         | 0.1          | 825.4                         | 0.4          | 826.4                         | 0.4          |  |
|   | 5   | 20               | 821.9                         | -0.1         | 823.3                         | 0.2          | 823.8                         | 0.1          |  |

**Annex 3**
**Dependence of measured value on mains voltage**

|   |     |             |   |          |   |                         |   |          |  |  |
|---|-----|-------------|---|----------|---|-------------------------|---|----------|--|--|
| <b>Manufacturer</b> Met One Instruments |     |             | <b>Standards</b> RP                       |          |   | built-in reference foil |   |          |  |  |
| <b>Type</b> BAM-1020                    |     |             |   |          |   |                         |   |          |  |  |
| <b>Serial-No.</b> SN 17010 & SN 17011   |     |             |   |          |   |                         |   |          |  |  |
|   |     |             | Cycle 1                                   |          | Cycle 2                                   |                         | Cycle 3                                   |          |  |  |
| SN 17010                                | No. | Voltage [V] | Measured value foil [µg/cm <sup>2</sup> ] | Dev. [%] | Measured value foil [µg/cm <sup>2</sup> ] | Dev. [%]                | Measured value foil [µg/cm <sup>2</sup> ] | Dev. [%] |  |  |
| RP                                      | 1   | 230         | 827.7                                     | -        | 828.6                                     | -                       | 828.4                                     | -        |  |  |
|   | 2   | 190         | 828.3                                     | 0.1      | 829.3                                     | 0.1                     | 829.9                                     | 0.2      |  |  |
|   | 3   | 230         | 828.8                                     | 0.1      | 828.2                                     | 0.0                     | 828.2                                     | 0.0      |  |  |
|   | 4   | 245         | 828.1                                     | 0.0      | 828.1                                     | -0.1                    | 829.3                                     | 0.1      |  |  |
|   | 5   | 230         | 829.8                                     | 0.3      | 828.4                                     | 0.0                     | 829.0                                     | 0.1      |  |  |
| SN 17011                                | No. | Voltage [V] | Measured value foil [µg/cm <sup>2</sup> ] | Dev. [%] | Measured value foil [µg/cm <sup>2</sup> ] | Dev. [%]                | Measured value foil [µg/cm <sup>2</sup> ] | Dev. [%] |  |  |
| RP                                      | 1   | 230         | 823.1                                     | -        | 823.2                                     | -                       | 822.4                                     | -        |  |  |
|   | 2   | 190         | 823.2                                     | 0.0      | 822.7                                     | -0.1                    | 823.3                                     | 0.1      |  |  |
|   | 3   | 230         | 822.1                                     | -0.1     | 821.6                                     | -0.2                    | 823.7                                     | 0.2      |  |  |
|   | 4   | 245         | 823.4                                     | 0.0      | 823.1                                     | 0.0                     | 822.4                                     | 0.0      |  |  |
|   | 5   | 230         | 821.8                                     | -0.2     | 822.5                                     | -0.1                    | 822.6                                     | 0.0      |  |  |

Report on the suitability test of the ambient air quality measurement system  
BAM-1020 with PM2.5 pre-separator of the company Met One Instruments,  
Inc. for the component suspended particulate matter PM2.5,  
Report-No.: 936/21209919/A

**Annex 4**

**Measured values from the field test sites, related to ambient conditions**

| Manufacturer Met One Instruments<br>Type BAM-1020<br>Serial-No. SN 17010 & SN 17011 |           |                            |                            |                           |                           |                            |                              |                              |                    | PM2.5, ambient air<br>Measured values in µg/m³, ambient cond. |  |
|---|-----------|----------------------------|----------------------------|---------------------------|---------------------------|----------------------------|------------------------------|------------------------------|--------------------|---|--|
| No.   | Date      | Ref. 1<br>PM2.5<br>[µg/m³] | Ref. 2<br>PM2.5<br>[µg/m³] | Ref. 1<br>PM10<br>[µg/m³] | Ref. 2<br>PM10<br>[µg/m³] | Ratio<br>PM2.5/PM10<br>[%] | SN 17010<br>PM2.5<br>[µg/m³] | SN 17011<br>PM2.5<br>[µg/m³] | Remark             | Test site   |  |
| 1   | 7/24/2008 |                            |                            | 32.9                      | 32.0                      |                            |                              |                              | Zero filter        | Teddington<br>(Summer)  |  |
| 2   | 7/25/2008 | 15.4                       | 15.1                       | 22.5                      | 23.6                      | 65.9                       | 13.6                         | 15.3                         |                    |   |  |
| 3   | 7/26/2008 |                            |                            | 21.0                      | 21.6                      |                            | 15.5                         | 14.1                         | Outlier Ref. PM2.5 |   |  |
| 4   | 7/27/2008 | 13.1                       | 13.2                       | 19.0                      | 19.9                      | 67.8                       | 16.5                         | 15.5                         |                    |   |  |
| 5   | 7/28/2008 | 13.5                       | 13.6                       | 20.3                      | 20.3                      | 66.9                       | 15.0                         | 15.1                         |                    |   |  |
| 6   | 7/29/2008 | 4.2                        | 4.7                        | 11.8                      | 12.1                      | 37.4                       | 7.7                          | 6.0                          |                    |   |  |
| 7   | 7/30/2008 | 9.6                        | 9.5                        | 16.2                      | 16.5                      | 58.4                       | 12.2                         | 9.5                          |                    |   |  |
| 8   | 7/31/2008 | 10.8                       | 11.0                       | 22.2                      | 22.4                      | 49.0                       | 15.2                         | 15.5                         |                    |   |  |
| 9   | 8/1/2008  | 4.2                        | 5.5                        | 16.3                      | 15.5                      | 30.3                       | 9.1                          | 7.7                          |                    |   |  |
| 10  | 8/2/2008  | 2.4                        | 2.2                        |                           |                           |                            | 5.3                          | 4.4                          | Outlier Ref. PM10  |   |  |
| 11  | 8/3/2008  | 2.0                        | 2.5                        | 8.2                       | 8.4                       | 26.8                       | 3.0                          | 4.9                          |                    |   |  |
| 12  | 8/4/2008  | 3.4                        | 4.4                        | 9.4                       | 9.6                       | 41.1                       | 5.2                          | 4.7                          |                    |   |  |
| 13  | 8/5/2008  | 3.1                        | 3.6                        | 7.5                       | 7.3                       | 45.1                       | 8.4                          | 7.0                          |                    |   |  |
| 14  | 8/6/2008  |                            |                            |                           |                           |                            |                              |                              | Power loss         |   |  |
| 15  | 8/7/2008  | 5.4                        | 6.2                        | 11.9                      | 11.4                      | 50.2                       |                              |                              | Power loss         |   |  |
| 16  | 8/8/2008  | 5.2                        | 6.2                        | 9.9                       | 9.6                       | 58.5                       | 7.8                          | 6.7                          |                    |   |  |
| 17  | 8/9/2008  | 2.3                        | 3.3                        | 7.1                       | 7.3                       | 39.3                       | 5.0                          | 6.4                          |                    |   |  |
| 18  | 8/10/2008 | 3.9                        | 4.1                        | 11.7                      | 11.2                      | 34.7                       | 4.0                          | 5.1                          |                    |   |  |
| 19  | 8/11/2008 | 5.6                        | 6.0                        | 13.7                      | 13.5                      | 42.7                       | 6.1                          | 6.4                          |                    |   |  |
| 20  | 8/12/2008 | 3.5                        | 3.5                        | 10.6                      | 10.5                      | 33.2                       | 3.1                          | 3.3                          |                    |   |  |
| 21  | 8/13/2008 | 3.5                        | 3.8                        | 11.8                      | 11.4                      | 31.7                       | 4.2                          | 3.7                          |                    |   |  |
| 22  | 8/14/2008 | 6.1                        | 6.5                        | 11.0                      | 11.1                      | 56.9                       | 7.6                          | 6.0                          |                    |   |  |
| 23  | 8/15/2008 | 5.6                        | 6.3                        | 10.0                      | 11.6                      | 55.4                       | 6.6                          | 5.0                          |                    |   |  |
| 24  | 8/16/2008 | 5.5                        | 5.5                        |                           |                           |                            | 5.7                          | 4.8                          | Outlier Ref. PM10  |   |  |
| 25  | 8/17/2008 | 2.7                        | 2.7                        | 8.7                       | 8.5                       | 31.2                       | 3.7                          | 4.3                          |                    |   |  |
| 26  | 8/18/2008 |                            |                            |                           |                           |                            |                              |                              | Zero filter        |   |  |
| 27  | 8/19/2008 | 4.6                        | 4.7                        | 12.5                      | 13.0                      | 36.6                       | 5.2                          | 7.0                          |                    |   |  |
| 28  | 8/20/2008 | 3.9                        | 4.1                        | 10.2                      | 10.1                      | 39.6                       | 6.4                          | 6.2                          |                    |   |  |
| 29  | 8/21/2008 | 6.5                        | 6.8                        | 13.2                      | 13.5                      | 50.2                       | 8.9                          | 7.5                          |                    |   |  |
| 30  | 8/22/2008 | 5.2                        | 4.9                        | 9.5                       | 9.3                       | 53.6                       | 6.3                          | 5.0                          |                    |   |  |



**Annex 4**
**Measured values from the field test sites, related to ambient conditions**

| <b>Manufacturer</b> Met One Instruments |           |   |   |  |  |                            | PM2.5, ambient air                                   |   |   |                        |
|---|-----------|---|---|--|--|----------------------------|--|---|---|------------------------|
| <b>Type</b> BAM-1020                    |           |   |   |  |  |                            | Measured values in µg/m <sup>3</sup> , ambient cond. |   |   |                        |
| <b>Serial-No.</b> SN 17010 & SN 17011   |           |   |   |  |  |                            |  |   |   |                        |
| No.                                     | Date      | Ref. 1<br>PM2.5<br>[µg/m <sup>3</sup> ] | Ref. 2<br>PM2.5<br>[µg/m <sup>3</sup> ] | Ref. 1<br>PM10<br>[µg/m <sup>3</sup> ] | Ref. 2<br>PM10<br>[µg/m <sup>3</sup> ] | Ratio<br>PM2.5/PM10<br>[%] | SN 17010<br>PM2.5<br>[µg/m <sup>3</sup> ]            | SN 17011<br>PM2.5<br>[µg/m <sup>3</sup> ] | Remark  | Test site              |
| 31                                      | 8/23/2008 | 4.5                                     | 4.4                                     | 9.2                                    | 9.5                                    | 47.4                       | 7.0  | 5.6                                       |   | Teddington<br>(Summer) |
| 32                                      | 8/24/2008 | 3.5                                     | 3.5                                     | 8.6                                    | 8.7                                    | 40.3                       | 5.7  | 4.3                                       |   |                        |
| 33                                      | 8/25/2008 | 6.5                                     | 6.5                                     | 12.9                                   | 13.0                                   | 50.0                       | 10.2   | 9.9                                       |   |                        |
| 34                                      | 8/26/2008 | 4.8                                     | 4.9                                     | 10.7                                   | 9.5                                    | 47.9                       | 8.3  | 7.0                                       |   |                        |
| 35                                      | 8/27/2008 | 7.4                                     | 7.0                                     | 13.4                                   | 13.6                                   | 53.2                       | 10.7   | 10.4                                      |   |                        |
| 36                                      | 8/28/2008 | 9.6                                     | 9.3                                     | 14.1                                   | 14.2                                   | 66.8                       | 12.1   | 12.4                                      |   |                        |
| 37                                      | 8/29/2008 | 13.7                                    | 12.8                                    | 20.1                                   | 19.1                                   | 67.8                       | 16.8   | 19.3                                      |   |                        |
| 38                                      | 8/30/2008 | 31.6                                    | 30.5                                    | 43.8                                   | 43.2                                   | 71.4                       | 38.3   | 39.2                                      |   |                        |
| 39                                      | 8/31/2008 | 13.3                                    | 12.1                                    | 22.0                                   | 21.6                                   | 58.5                       | 18.7   | 16.8                                      |   |                        |
| 40                                      | 9/1/2008  | 2.9                                     | 2.6                                     | 8.1                                    | 8.1                                    | 33.9                       | 5.5  | 4.6                                       |   |                        |
| 41                                      | 9/2/2008  | 3.0                                     | 2.4                                     | 11.8                                   | 12.4                                   | 22.3                       | 4.1  | 5.0                                       |   |                        |
| 42                                      | 9/3/2008  | 3.6                                     | 3.3                                     | 14.2                                   | 14.3                                   | 24.2                       | 5.5  | 6.0                                       |   |                        |
| 43                                      | 9/4/2008  | 4.1                                     | 3.7                                     |  |  |                            | 6.5  | 4.4                                       |   |                        |
| 44                                      | 9/5/2008  | 2.6                                     | 2.7                                     | 7.5                                    | 7.6                                    | 35.0                       | 2.7  |   | Outlier Ref. PM10<br>Reference foil 17011 stuck, 4h<br>loss because of repair |                        |
| 45                                      | 9/6/2008  | 3.4                                     | 3.6                                     | 8.0                                    | 7.6                                    | 44.9                       | 4.1  | 4.8                                       |   |                        |
| 46                                      | 9/7/2008  | 3.1                                     | 2.7                                     | 8.4                                    | 8.2                                    | 34.8                       | 5.8  | 4.9                                       |   |                        |
| 47                                      | 9/8/2008  | 6.4                                     | 6.6                                     | 14.7                                   | 14.2                                   | 45.0                       | 9.0  | 7.5                                       |   |                        |
| 48                                      | 9/9/2008  | 6.0                                     | 5.2                                     | 14.4                                   | 14.2                                   | 39.1                       | 8.3  | 6.4                                       |   |                        |
| 49                                      | 9/10/2008 | 4.3                                     | 4.1                                     | 11.0                                   | 10.6                                   | 38.6                       | 10.1   | 6.1                                       |   |                        |
| 50                                      | 9/11/2008 | 6.5                                     | 5.4                                     | 17.2                                   | 17.5                                   | 34.2                       | 9.2  | 7.0                                       |   |                        |
| 51                                      | 9/12/2008 | 5.5                                     | 5.1                                     | 9.4                                    | 9.1                                    | 57.3                       | 8.0  | 6.4                                       |   |                        |
| 52                                      | 9/13/2008 | 15.5                                    | 15.4                                    | 20.4                                   | 20.7                                   | 75.5                       | 18.8   | 16.2                                      |   |                        |
| 53                                      | 9/14/2008 | 10.9                                    | 10.3                                    | 18.1                                   | 17.4                                   | 60.0                       | 13.0   | 11.2                                      |   |                        |
| 54                                      | 9/15/2008 | 11.8                                    | 12.3                                    | 17.5                                   | 17.5                                   | 68.6                       | 12.5   | 11.3                                      |   |                        |
| 55                                      | 9/16/2008 | 17.7                                    | 17.4                                    | 24.6                                   | 24.2                                   | 72.0                       | 18.5   | 17.1                                      |   |                        |
| 56                                      | 9/17/2008 | 19.4                                    | 19.2                                    | 26.9                                   | 28.1                                   | 70.3                       | 20.0   | 18.6                                      |   |                        |
| 57                                      | 9/18/2008 | 17.0                                    | 17.2                                    | 24.5                                   | 23.6                                   | 71.3                       | 17.9   | 16.9                                      |   |                        |
| 58                                      | 9/19/2008 | 20.7                                    | 20.9                                    | 29.3                                   | 29.4                                   | 70.9                       | 22.9   | 21.3                                      |   |                        |
| 59                                      | 9/20/2008 | 21.7                                    | 21.4                                    | 26.9                                   | 26.6                                   | 80.6                       | 23.2   | 22.4                                      |   |                        |
| 60                                      | 9/21/2008 | 21.6                                    | 22.0                                    | 28.6                                   | 28.1                                   | 76.9                       | 23.8   | 21.3                                      |   |                        |

Report on the suitability test of the ambient air quality measurement system  
BAM-1020 with PM2.5 pre-separator of the company Met One Instruments,  
Inc. for the component suspended particulate matter PM2.5,  
Report-No.: 936/21209919/A

**Annex 4**

**Measured values from the field test sites, related to ambient conditions**

| Manufacturer Met One Instruments<br>Type BAM-1020<br>Serial-No. SN 17010 & SN 17011 |            |                            |                            |                           |                           |                            |                              |                              |   | PM2.5, ambient air<br>Measured values in µg/m³, ambient cond. |  |
|---|------------|----------------------------|----------------------------|---------------------------|---------------------------|----------------------------|------------------------------|------------------------------|---|---|--|
| No.   | Date       | Ref. 1<br>PM2.5<br>[µg/m³] | Ref. 2<br>PM2.5<br>[µg/m³] | Ref. 1<br>PM10<br>[µg/m³] | Ref. 2<br>PM10<br>[µg/m³] | Ratio<br>PM2.5/PM10<br>[%] | SN 17010<br>PM2.5<br>[µg/m³] | SN 17011<br>PM2.5<br>[µg/m³] | Remark  | Test site   |  |
| 61  | 9/22/2008  | 14.8                       | 15.0                       | 22.3                      | 22.6                      | 66.3                       | 17.4                         | 15.3                         | Zero filter<br>Filtertape 17010 cracked   | Teddington<br>(Summer)  |  |
| 62  | 9/23/2008  | 6.3                        | 6.1                        | 18.0                      | 17.8                      | 34.5                       |                              |                              |   |   |  |
| 63  | 9/24/2008  | 11.4                       | 11.4                       | 18.8                      | 19.7                      | 59.1                       |                              | 13.5                         |   |   |  |
| 64  | 9/25/2008  | 16.1                       | 16.5                       | 26.7                      | 26.4                      | 61.2                       | 19.0                         | 17.9                         |   |   |  |
| 65  | 9/26/2008  | 17.5                       | 17.4                       | 29.9                      | 29.7                      | 58.5                       | 21.1                         | 19.4                         |   |   |  |
| 66  | 9/27/2008  | 27.2                       | 27.2                       | 35.7                      | 35.6                      | 76.4                       | 29.9                         | 28.4                         |   |   |  |
| 67  | 9/28/2008  |                            |                            |                           |                           |                            | 20.4                         | 17.8                         |   |   |  |
| 68  | 9/29/2008  | 4.3                        | 4.4                        | 7.4                       | 8.5                       | 54.9                       | 5.3                          | 3.6                          |   |   |  |
| 69  | 9/30/2008  | 3.2                        | 3.3                        | 6.9                       | 6.7                       | 48.3                       | 3.9                          | 3.7                          |   |   |  |
| 70  | 10/1/2008  |                            |                            |                           |                           |                            | 3.5                          | 2.4                          |   |   |  |
| 71  | 10/2/2008  |                            |                            |                           |                           |                            | 5.4                          | 3.9                          |   |   |  |
| 72  | 10/3/2008  |                            |                            |                           |                           |                            | 7.3                          | 5.7                          |   |   |  |
| 73  | 10/4/2008  |                            |                            |                           |                           |                            | 3.0                          | 1.4                          |   |   |  |
| 74  | 10/5/2008  |                            |                            |                           |                           |                            | 5.7                          | 3.7                          |   |   |  |
| 75  | 10/6/2008  |                            |                            |                           |                           |                            | 7.5                          | 6.4                          |   |   |  |
| 76  | 10/7/2008  |                            |                            |                           |                           |                            | 5.5                          | 5.4                          |   |   |  |
| 77  | 10/8/2008  |                            |                            |                           |                           |                            | 14.0                         | 11.3                         |   |   |  |
| 78  | 10/9/2008  | 8.9                        | 10.1                       | 18.4                      | 18.0                      | 52.2                       | 11.2                         | 9.8                          |   |   |  |
| 79  | 10/10/2008 | 10.5                       | 10.6                       | 19.5                      | 19.6                      | 54.1                       | 12.4                         | 10.8                         |   |   |  |
| 80  | 10/11/2008 | 15.6                       | 15.8                       | 22.6                      | 22.6                      | 69.5                       | 20.7                         | 17.8                         |   |   |  |
| 81  | 10/12/2008 | 20.4                       | 21.1                       | 25.9                      | 25.9                      | 80.1                       | 23.4                         | 21.5                         |   |   |  |
| 82  | 10/13/2008 | 8.3                        | 8.4                        | 14.6                      | 14.4                      | 57.6                       | 10.5                         | 9.5                          |   |   |  |
| 83  | 10/14/2008 | 6.1                        | 6.4                        | 11.4                      | 12.2                      | 52.7                       | 10.2                         | 7.1                          |   |   |  |
| 84  | 10/15/2008 | 3.9                        | 3.8                        | 8.2                       | 8.6                       | 46.0                       | 5.7                          | 3.1                          |   |   |  |
| 85  | 10/16/2008 |                            |                            |                           |                           |                            |                              |                              | Zero filter<br>Not in operation<br>Not in operation<br>Not in operation<br>Not in operation |   |  |
| 86  | 10/17/2008 |                            |                            |                           |                           |                            |                              |                              |   |   |  |
| 87  | 10/18/2008 |                            |                            |                           |                           |                            |                              |                              |   |   |  |
| 88  | 10/19/2008 |                            |                            |                           |                           |                            |                              |                              |   |   |  |
| 89  | 10/20/2008 |                            |                            |                           |                           |                            |                              |                              |   |   |  |
| 90  | 10/21/2008 |                            |                            |                           |                           |                            | 7.5                          | 7.5                          |   |   |  |

**Annex 4**
**Measured values from the field test sites, related to ambient conditions**
**Page 4 of 13**

| <b>Manufacturer</b> Met One Instruments |            |                            |                            |                           |                           |                            | PM2.5, ambient air                      |                              |                   |                        |
|---|------------|----------------------------|----------------------------|---------------------------|---------------------------|----------------------------|---|------------------------------|-------------------|------------------------|
| <b>Type</b> BAM-1020                    |            |                            |                            |                           |                           |                            | Measured values in µg/m³, ambient cond. |                              |                   |                        |
| <b>Serial-No.</b> SN 17010 & SN 17011   |            |                            |                            |                           |                           |                            |   |                              |                   |                        |
| No.                                     | Date       | Ref. 1<br>PM2.5<br>[µg/m³] | Ref. 2<br>PM2.5<br>[µg/m³] | Ref. 1<br>PM10<br>[µg/m³] | Ref. 2<br>PM10<br>[µg/m³] | Ratio<br>PM2.5/PM10<br>[%] | SN 17010<br>PM2.5<br>[µg/m³]            | SN 17011<br>PM2.5<br>[µg/m³] | Remark            | Test site              |
| 91                                      | 10/22/2008 |                            |                            |                           |                           |                            | 8.2                                     | 7.7                          |                   | Teddington<br>(Summer) |
| 92                                      | 10/23/2008 |                            |                            |                           |                           |                            | 5.4                                     | 4.2                          |                   |                        |
| 93                                      | 10/24/2008 |                            |                            |                           |                           |                            | 12.1                                    | 10.5                         |                   |                        |
| 94                                      | 10/25/2008 |                            |                            |                           |                           |                            | 11.2                                    | 9.5                          |                   |                        |
| 95                                      | 10/26/2008 |                            |                            |                           |                           |                            | 4.4                                     | 2.2                          |                   |                        |
| 96                                      | 10/27/2008 |                            |                            |                           |                           |                            | 11.0                                    | 9.4                          |                   |                        |
| 97                                      | 10/28/2008 |                            |                            |                           |                           |                            | 6.8                                     | 8.5                          |                   |                        |
| 98                                      | 10/29/2008 |                            |                            |                           |                           |                            | 15.8                                    | 17.1                         |                   |                        |
| 99                                      | 10/30/2008 |                            |                            |                           |                           |                            | 10.5                                    | 11.0                         |                   |                        |
| 100                                     | 10/31/2008 | 11.7                       | 12.0                       | 16.9                      | 18.5                      | 66.9                       | 9.5                                     | 10.2                         |                   |                        |
| 101                                     | 11/1/2008  | 14.8                       | 15.1                       | 18.3                      | 19.2                      | 79.9                       | 12.6                                    | 14.2                         |                   |                        |
| 102                                     | 11/2/2008  | 20.4                       | 20.0                       | 25.5                      | 25.8                      | 78.7                       | 18.0                                    | 20.0                         |                   |                        |
| 103                                     | 11/3/2008  | 20.7                       | 20.9                       | 27.0                      | 27.8                      | 76.0                       | 19.0                                    | 20.5                         |                   |                        |
| 104                                     | 11/4/2008  | 31.1                       | 30.9                       | 37.5                      | 38.4                      | 81.7                       | 29.5                                    | 31.6                         |                   |                        |
| 105                                     | 11/5/2008  | 29.7                       | 29.6                       | 35.5                      | 36.2                      | 82.8                       | 26.6                                    | 29.3                         |                   |                        |
| 106                                     | 11/6/2008  | 23.5                       | 23.8                       | 28.2                      | 28.6                      | 83.2                       | 21.2                                    | 23.6                         |                   |                        |
| 107                                     | 11/7/2008  | 6.8                        | 6.7                        | 15.2                      | 14.7                      | 45.4                       | 6.6                                     | 8.0                          |                   |                        |
| 108                                     | 11/8/2008  | 3.5                        | 3.5                        | 8.6                       | 9.4                       | 39.1                       | 3.7                                     | 4.1                          |                   |                        |
| 109                                     | 11/9/2008  | 4.1                        | 4.0                        | 11.5                      | 11.9                      | 34.8                       | 4.5                                     | 3.9                          |                   |                        |
| 110                                     | 12/4/2008  |                            |                            |                           |                           |                            | 6.2                                     | 8.4                          |                   | Cologne<br>(Winter)    |
| 111                                     | 12/5/2008  | 9.1                        | 9.2                        | 12.5                      | 13.0                      | 71.6                       | 7.5                                     | 9.9                          |                   |                        |
| 112                                     | 12/6/2008  |                            |                            |                           |                           |                            | 13.8                                    | 18.0                         |                   |                        |
| 113                                     | 12/7/2008  | 17.4                       | 17.2                       | 22.6                      | 22.8                      | 76.1                       | 16.7                                    | 18.4                         |                   |                        |
| 114                                     | 12/8/2008  | 15.2                       | 15.8                       | 18.2                      | 18.3                      | 84.8                       | 14.1                                    | 16.7                         |                   |                        |
| 115                                     | 12/9/2008  | 22.7                       | 22.2                       |                           |                           |                            | 20.7                                    | 24.9                         | Outlier Ref. PM10 |                        |
| 116                                     | 12/10/2008 | 19.9                       | 18.8                       | 24.1                      | 23.9                      | 80.6                       | 18.8                                    | 20.4                         |                   |                        |
| 117                                     | 12/11/2008 | 24.0                       | 24.0                       | 28.3                      | 29.3                      | 83.2                       | 22.4                                    | 25.1                         |                   |                        |
| 118                                     | 12/12/2008 | 17.3                       | 16.6                       | 19.1                      | 19.5                      | 87.8                       | 15.5                                    | 18.1                         |                   |                        |
| 119                                     | 12/13/2008 | 17.9                       | 18.5                       |                           |                           |                            | 16.9                                    | 19.1                         | Outlier Ref. PM10 |                        |
| 120                                     | 12/14/2008 |                            |                            |                           |                           |                            | 36.6                                    | 42.1                         |                   |                        |

Report on the suitability test of the ambient air quality measurement system  
BAM-1020 with PM2.5 pre-separator of the company Met One Instruments,  
Inc. for the component suspended particulate matter PM2.5,  
Report-No.: 936/21209919/A

**Annex 4**

**Measured values from the field test sites, related to ambient conditions**

| Manufacturer Met One Instruments<br>Type BAM-1020<br>Serial-No. SN 17010 & SN 17011 |            |                            |                            |                           |                           |                            |                              |                              |             | PM2.5, ambient air<br>Measured values in µg/m³, ambient cond. |  |
|---|------------|----------------------------|----------------------------|---------------------------|---------------------------|----------------------------|------------------------------|------------------------------|-------------|---|--|
| No.   | Date       | Ref. 1<br>PM2.5<br>[µg/m³] | Ref. 2<br>PM2.5<br>[µg/m³] | Ref. 1<br>PM10<br>[µg/m³] | Ref. 2<br>PM10<br>[µg/m³] | Ratio<br>PM2.5/PM10<br>[%] | SN 17010<br>PM2.5<br>[µg/m³] | SN 17011<br>PM2.5<br>[µg/m³] | Remark      | Test site   |  |
| 121   | 12/15/2008 | 31.3                       | 31.4                       | 34.9                      | 34.7                      | 90.1                       | 31.5                         | 32.5                         |             | Cologne<br>(Winter)   |  |
| 122   | 12/16/2008 | 16.8                       | 16.4                       | 19.6                      | 20.4                      | 83.1                       | 17.6                         | 20.2                         |             |   |  |
| 123   | 12/17/2008 | 20.1                       | 20.1                       | 32.3                      | 33.2                      | 61.5                       | 22.5                         | 25.1                         |             |   |  |
| 124   | 12/18/2008 |                            |                            |                           |                           |                            | 12.1                         | 14.5                         |             |   |  |
| 125   | 12/19/2008 |                            |                            | 20.3                      | 21.6                      |                            | 10.5                         | 12.1                         |             |   |  |
| 126   | 12/20/2008 |                            |                            |                           |                           |                            | 7.4                          | 8.9                          |             |   |  |
| 127   | 12/21/2008 | 7.1                        | 8.5                        | 11.1                      | 11.1                      | 70.5                       | 8.6                          | 8.7                          |             |   |  |
| 128   | 12/22/2008 |                            |                            |                           |                           |                            | 15.4                         | 15.9                         |             |   |  |
| 129   | 12/23/2008 |                            |                            |                           |                           |                            | 21.2                         | 22.6                         |             |   |  |
| 130   | 12/24/2008 |                            |                            |                           |                           |                            | 24.1                         | 25.4                         |             |   |  |
| 131   | 12/25/2008 |                            |                            |                           |                           |                            | 8.2                          | 7.4                          |             |   |  |
| 132   | 12/26/2008 |                            |                            |                           |                           |                            | 12.0                         | 12.3                         |             |   |  |
| 133   | 12/27/2008 |                            |                            |                           |                           |                            | 19.7                         | 20.9                         |             |   |  |
| 134   | 12/28/2008 | 27.9                       | 27.9                       | 33.7                      | 33.9                      | 82.6                       | 27.0                         | 30.3                         |             |   |  |
| 135   | 12/29/2008 |                            |                            |                           |                           |                            | 33.5                         | 37.0                         |             |   |  |
| 136   | 12/30/2008 |                            |                            |                           |                           |                            | 45.7                         | 48.9                         |             |   |  |
| 137   | 12/31/2008 |                            |                            |                           |                           |                            | 98.2                         | 111.5                        |             |   |  |
| 138   | 1/1/2009   |                            |                            |                           |                           |                            | 82.0                         | 88.9                         |             |   |  |
| 139   | 1/2/2009   |                            |                            |                           |                           |                            | 46.3                         | 47.5                         |             |   |  |
| 140   | 1/3/2009   |                            |                            |                           |                           |                            | 32.9                         | 36.9                         |             |   |  |
| 141   | 1/4/2009   | 30.0                       | 30.4                       | 35.1                      | 36.7                      | 84.1                       | 28.7                         | 32.1                         |             |   |  |
| 142   | 1/5/2009   | 14.7                       | 15.4                       | 17.0                      | 16.3                      | 90.3                       | 14.1                         | 16.8                         |             |   |  |
| 143   | 1/6/2009   | 34.6                       | 34.8                       | 49.7                      | 48.6                      | 70.7                       | 39.4                         | 43.0                         |             |   |  |
| 144   | 1/7/2009   |                            |                            |                           |                           |                            |                              |                              | Zero filter |   |  |
| 145   | 1/8/2009   |                            |                            |                           |                           |                            | 35.5                         | 36.3                         |             |   |  |
| 146   | 1/9/2009   | 38.8                       | 38.6                       | 48.6                      | 47.7                      | 80.4                       | 37.0                         | 41.6                         |             |   |  |
| 147   | 1/10/2009  | 45.7                       | 44.6                       | 48.3                      | 48.8                      | 92.9                       | 39.9                         | 45.4                         |             |   |  |
| 148   | 1/11/2009  |                            |                            |                           |                           |                            | 41.9                         | 46.5                         |             |   |  |
| 149   | 1/12/2009  | 38.4                       | 38.4                       | 42.7                      | 42.9                      | 89.7                       | 36.0                         | 39.4                         |             |   |  |
| 150   | 1/13/2009  | 36.3                       | 36.0                       | 41.7                      | 41.6                      | 86.8                       | 34.3                         | 38.3                         |             |   |  |

**Annex 4**
**Measured values from the field test sites, related to ambient conditions**

| Manufacturer Met One Instruments<br>Type BAM-1020<br>Serial-No. SN 17010 & SN 17011 |           |   |   |  |  |                            |   |   |                    | PM2.5, ambient air<br>Measured values in µg/m <sup>3</sup> , ambient cond. |  |
|---|-----------|---|---|--|--|----------------------------|---|---|--------------------|--|--|
| No.   | Date      | Ref. 1<br>PM2.5<br>[µg/m <sup>3</sup> ] | Ref. 2<br>PM2.5<br>[µg/m <sup>3</sup> ] | Ref. 1<br>PM10<br>[µg/m <sup>3</sup> ] | Ref. 2<br>PM10<br>[µg/m <sup>3</sup> ] | Ratio<br>PM2.5/PM10<br>[%] | SN 17010<br>PM2.5<br>[µg/m <sup>3</sup> ] | SN 17011<br>PM2.5<br>[µg/m <sup>3</sup> ] | Remark             | Test site  |  |
| 151   | 1/14/2009 | 31.1                                    | 31.3                                    | 38.2                                   | 38.2                                   | 81.5                       | 30.1                                      | 33.7                                      |                    | Cologne<br>(Winter)  |  |
| 152   | 1/15/2009 | 28.4                                    | 28.5                                    | 32.2                                   | 32.0                                   | 88.6                       | 27.9                                      | 31.3                                      |                    |  |  |
| 153   | 1/16/2009 | 36.6                                    | 36.8                                    | 39.9                                   | 40.2                                   | 91.6                       | 35.5                                      | 39.3                                      |                    |  |  |
| 154   | 1/17/2009 |   |   |  |  |                            | 16.8                                      | 16.5                                      |                    |  |  |
| 155   | 1/18/2009 | 5.0                                     | 4.4                                     | 8.5                                    | 7.9                                    | 57.3                       | 5.9                                       | 6.1                                       |                    |  |  |
| 156   | 1/19/2009 | 3.0                                     | 3.3                                     | 6.7                                    | 5.9                                    | 50.0                       | 5.0                                       | 4.9                                       |                    |  |  |
| 157   | 1/20/2009 |   |   | 14.2                                   | 14.5                                   |                            | 9.7                                       | 11.0                                      | Outlier Ref. PM2.5 |  |  |
| 158   | 1/21/2009 | 16.0                                    | 16.0                                    | 21.2                                   | 21.6                                   | 74.5                       | 16.3                                      | 17.8                                      |                    |  |  |
| 159   | 1/22/2009 | 6.2                                     | 6.3                                     | 9.0                                    | 8.6                                    | 71.3                       | 7.7                                       | 7.2                                       |                    |  |  |
| 160   | 1/23/2009 | 5.3                                     | 4.9                                     | 9.2                                    | 9.1                                    | 55.5                       | 7.2                                       | 7.2                                       |                    |  |  |
| 161   | 1/24/2009 |   |   |  |  |                            | 17.4                                      | 18.7                                      |                    |  |  |
| 162   | 1/25/2009 | 16.4                                    | 16.6                                    | 21.0                                   | 20.4                                   | 79.4                       | 16.4                                      | 17.6                                      |                    |  |  |
| 163   | 1/26/2009 | 35.1                                    | 35.5                                    | 44.8                                   | 43.8                                   | 79.6                       | 38.9                                      | 39.9                                      |                    |  |  |
| 164   | 1/27/2009 | 31.0                                    | 31.2                                    | 37.4                                   | 37.5                                   | 83.0                       | 33.6                                      | 34.3                                      |                    |  |  |
| 165   | 1/28/2009 | 29.9                                    | 29.4                                    | 33.5                                   | 33.9                                   | 87.9                       | 31.5                                      | 31.7                                      |                    |  |  |
| 166   | 1/29/2009 |   |   |  |  |                            | 28.4                                      | 31.3                                      |                    |  |  |
| 167   | 1/30/2009 | 23.6                                    | 24.1                                    | 29.5                                   | 29.2                                   | 81.2                       | 29.4                                      | 26.6                                      |                    |  |  |
| 168   | 1/31/2009 |   |   |  |  |                            | 7.1                                       | 7.9                                       |                    |  |  |
| 169   | 2/1/2009  | 15.2                                    | 15.6                                    | 17.8                                   | 18.1                                   | 85.9                       | 18.7                                      | 18.3                                      |                    |  |  |
| 170   | 2/2/2009  |   |   |  |  |                            |   |   | Zero filter        |  |  |
| 171   | 2/3/2009  |   |   | 41.3                                   | 41.0                                   |                            | 37.1                                      | 39.4                                      | Outlier Ref. PM2.5 |  |  |
| 172   | 2/4/2009  | 30.9                                    | 30.2                                    | 34.3                                   | 34.2                                   | 89.1                       | 33.0                                      | 33.5                                      |                    |  |  |
| 173   | 2/5/2009  | 17.6                                    | 17.1                                    | 21.2                                   | 21.2                                   | 81.9                       | 19.0                                      | 19.1                                      |                    |  |  |
| 174   | 2/6/2009  | 19.4                                    | 19.8                                    | 23.5                                   | 23.7                                   | 83.0                       | 22.5                                      | 22.9                                      |                    |  |  |
| 175   | 2/7/2009  |   |   |  |  |                            | 22.9                                      | 22.5                                      |                    |  |  |
| 176   | 2/8/2009  | 12.4                                    | 12.6                                    | 16.1                                   | 16.1                                   | 77.3                       | 15.2                                      | 13.8                                      |                    |  |  |
| 177   | 2/9/2009  | 7.1                                     | 6.7                                     | 10.8                                   | 10.4                                   | 64.9                       | 8.6                                       | 7.1                                       |                    |  |  |
| 178   | 2/10/2009 |   |   |  |  |                            | 8.3                                       | 8.2                                       |                    |  |  |
| 179   | 2/11/2009 | 11.5                                    | 11.9                                    | 16.8                                   | 16.6                                   | 70.1                       | 13.9                                      | 12.7                                      |                    |  |  |
| 180   | 2/12/2009 | 12.2                                    | 13.1                                    | 21.8                                   | 22.7                                   | 57.0                       | 16.9                                      | 16.4                                      |                    |  |  |

Report on the suitability test of the ambient air quality measurement system  
BAM-1020 with PM2.5 pre-separator of the company Met One Instruments,  
Inc. for the component suspended particulate matter PM2.5,  
Report-No.: 936/21209919/A

**Annex 4**

**Measured values from the field test sites, related to ambient conditions**

| Manufacturer Met One Instruments<br>Type BAM-1020<br>Serial-No. SN 17010 & SN 17011 |           |                            |                            |                           |                           |                            |                              |                              |                              | PM2.5, ambient air<br>Measured values in µg/m³, ambient cond. |  |
|---|-----------|----------------------------|----------------------------|---------------------------|---------------------------|----------------------------|------------------------------|------------------------------|------------------------------|---|--|
| No.   | Date      | Ref. 1<br>PM2.5<br>[µg/m³] | Ref. 2<br>PM2.5<br>[µg/m³] | Ref. 1<br>PM10<br>[µg/m³] | Ref. 2<br>PM10<br>[µg/m³] | Ratio<br>PM2.5/PM10<br>[%] | SN 17010<br>PM2.5<br>[µg/m³] | SN 17011<br>PM2.5<br>[µg/m³] | Remark                       | Test site   |  |
| 181   | 2/13/2009 | 19.8                       | 19.6                       | 25.9                      | 26.3                      | 75.4                       | 23.6                         | 22.2                         |                              | Cologne<br>(Winter)   |  |
| 182   | 2/14/2009 |                            |                            |                           |                           |                            | 28.9                         | 28.7                         |                              |   |  |
| 183   | 2/15/2009 | 19.5                       | 19.9                       | 24.7                      | 25.1                      | 79.0                       | 24.8                         | 22.2                         |                              |   |  |
| 184   | 2/16/2009 |                            |                            | 17.7                      | 18.2                      |                            | 15.8                         | 16.3                         | Ref.2 PM2.5 not in operation |   |  |
| 185   | 2/17/2009 | 10.7                       | 10.5                       | 12.7                      | 13.1                      | 82.0                       | 10.3                         | 11.0                         |                              |   |  |
| 186   | 2/18/2009 | 15.0                       | 14.5                       | 21.0                      | 21.6                      | 69.2                       | 14.9                         | 16.2                         |                              |   |  |
| 187   | 2/19/2009 | 30.9                       | 31.0                       | 38.8                      | 38.8                      | 79.7                       | 30.2                         | 31.7                         |                              |   |  |
| 188   | 2/20/2009 | 12.9                       | 13.1                       | 18.3                      | 18.3                      | 70.8                       | 14.7                         | 16.0                         |                              |   |  |
| 189   | 2/21/2009 |                            |                            |                           |                           |                            | 23.1                         | 24.7                         |                              |   |  |
| 190   | 2/22/2009 | 13.5                       | 13.9                       | 20.2                      | 20.8                      | 66.7                       | 15.0                         | 14.0                         |                              |   |  |
| 191   | 2/23/2009 | 6.6                        | 6.0                        | 14.6                      | 15.0                      | 42.4                       | 6.6                          | 8.5                          |                              |   |  |
| 192   | 2/24/2009 | 19.1                       | 18.9                       | 29.9                      | 30.5                      | 63.0                       | 20.3                         | 21.9                         |                              |   |  |
| 193   | 2/25/2009 | 26.9                       | 27.3                       | 36.3                      | 35.5                      | 75.4                       | 28.6                         | 28.4                         |                              |   |  |
| 194   | 2/26/2009 | 20.0                       | 19.6                       | 30.7                      | 30.7                      | 64.6                       | 19.8                         | 20.4                         |                              |   |  |
| 195   | 2/27/2009 | 21.1                       | 21.2                       | 28.3                      | 28.2                      | 74.9                       | 24.0                         | 22.4                         |                              |   |  |
| 196   | 2/28/2009 | 25.0                       | 25.0                       | 31.4                      | 31.5                      | 79.6                       | 26.5                         | 27.1                         |                              |   |  |
| 197   | 3/1/2009  |                            |                            |                           |                           |                            | 31.5                         | 33.1                         |                              |   |  |
| 198   | 3/2/2009  | 28.0                       | 27.8                       | 36.9                      | 37.1                      | 75.3                       | 28.0                         | 28.7                         |                              |   |  |
| 199   | 3/3/2009  | 20.8                       | 21.2                       | 25.9                      | 25.7                      | 81.4                       | 19.6                         | 21.4                         |                              |   |  |
| 200   | 3/4/2009  |                            |                            |                           |                           |                            |                              |                              | Zero filter                  |   |  |
| 201   | 3/5/2009  | 15.2                       | 13.7                       | 15.2                      | 16.0                      | 92.8                       | 14.7                         | 14.9                         |                              |   |  |
| 202   | 3/6/2009  | 16.1                       | 14.8                       | 21.4                      | 21.9                      | 71.6                       | 16.0                         | 17.9                         |                              |   |  |
| 203   | 3/7/2009  | 18.7                       | 18.9                       | 26.1                      | 26.1                      | 71.9                       | 18.7                         | 16.9                         |                              |   |  |
| 204   | 3/8/2009  |                            |                            |                           |                           |                            | 5.6                          | 6.9                          |                              |   |  |
| 205   | 3/9/2009  |                            |                            |                           |                           |                            | 8.0                          | 9.2                          |                              |   |  |
| 206   | 3/10/2009 |                            |                            |                           |                           |                            | 8.3                          | 9.7                          |                              |   |  |
| 207   | 3/11/2009 | 13.0                       | 13.2                       | 21.4                      | 21.6                      | 60.7                       | 13.9                         | 14.2                         |                              |   |  |
| 208   | 3/12/2009 | 19.1                       | 19.2                       | 24.1                      | 24.5                      | 78.8                       | 19.5                         | 21.5                         |                              |   |  |
| 209   | 3/13/2009 | 16.3                       | 16.9                       | 28.8                      | 28.2                      | 58.4                       | 17.1                         | 17.1                         |                              |   |  |
| 210   | 3/14/2009 | 17.2                       | 17.6                       | 25.7                      | 26.3                      | 66.9                       | 17.4                         | 18.2                         |                              |   |  |

**Annex 4**
**Measured values from the field test sites, related to ambient conditions**

| <b>Manufacturer</b> Met One Instruments |           |                            |                            |                           |                           |                            |                              |                              |             | PM2.5, ambient air                      |  |
|---|-----------|----------------------------|----------------------------|---------------------------|---------------------------|----------------------------|------------------------------|------------------------------|-------------|---|--|
| <b>Type</b> BAM-1020                    |           |                            |                            |                           |                           |                            |                              |                              |             | Measured values in µg/m³, ambient cond. |  |
| <b>Serial-No.</b> SN 17010 & SN 17011   |           |                            |                            |                           |                           |                            |                              |                              |             |   |  |
| No.                                     | Date      | Ref. 1<br>PM2.5<br>[µg/m³] | Ref. 2<br>PM2.5<br>[µg/m³] | Ref. 1<br>PM10<br>[µg/m³] | Ref. 2<br>PM10<br>[µg/m³] | Ratio<br>PM2.5/PM10<br>[%] | SN 17010<br>PM2.5<br>[µg/m³] | SN 17011<br>PM2.5<br>[µg/m³] | Remark      | Test site                               |  |
| 211                                     | 3/15/2009 |                            |                            |                           |                           |                            | 8.6                          | 10.5                         |             | Cologne<br>(Winter)                     |  |
| 212                                     | 3/16/2009 | 26.4                       | 26.4                       | 37.0                      | 37.5                      | 70.9                       | 28.9                         | 30.8                         |             |   |  |
| 213                                     | 3/17/2009 | 24.5                       | 24.9                       | 36.8                      | 36.7                      | 67.4                       | 24.0                         | 23.3                         |             |   |  |
| 214                                     | 3/18/2009 | 23.2                       | 23.8                       | 38.1                      | 38.6                      | 61.3                       | 22.6                         | 22.2                         |             |   |  |
| 215                                     | 3/19/2009 | 17.3                       | 17.9                       | 28.5                      | 29.2                      | 61.0                       | 15.4                         | 15.3                         |             |   |  |
| 216                                     | 3/20/2009 | 16.0                       | 14.1                       | 26.1                      | 27.0                      | 56.7                       | 13.8                         | 15.8                         |             |   |  |
| 217                                     | 3/21/2009 |                            |                            |                           |                           |                            | 43.5                         | 45.4                         |             |   |  |
| 218                                     | 3/22/2009 | 19.0                       | 18.5                       | 32.7                      | 32.1                      | 57.8                       | 20.1                         | 19.2                         |             |   |  |
| 219                                     | 3/23/2009 | 9.9                        | 10.1                       | 20.8                      | 20.4                      | 48.6                       | 10.2                         | 10.4                         |             |   |  |
| 220                                     | 3/24/2009 | 8.5                        | 8.9                        | 15.7                      | 16.0                      | 54.8                       | 8.0                          | 8.7                          |             |   |  |
| 221                                     | 3/25/2009 | 9.2                        | 8.8                        | 14.0                      | 14.4                      | 63.2                       | 10.1                         | 11.4                         |             |   |  |
| 222                                     | 3/26/2009 | 7.2                        | 7.8                        | 10.9                      | 11.5                      | 67.0                       | 8.2                          | 7.1                          |             |   |  |
| 223                                     | 3/27/2009 | 8.4                        | 8.4                        | 12.9                      | 12.3                      | 67.0                       | 8.5                          | 8.4                          |             |   |  |
| 224                                     | 3/28/2009 | 7.3                        | 6.5                        | 9.3                       | 8.9                       | 75.6                       | 5.7                          | 8.4                          |             |   |  |
| 225                                     | 3/29/2009 |                            |                            |                           |                           |                            | 14.2                         | 17.5                         |             |   |  |
| 226                                     | 3/30/2009 |                            |                            |                           |                           |                            | 24.2                         | 24.7                         |             |   |  |
| 227                                     | 3/31/2009 |                            |                            |                           |                           |                            | 24.1                         | 25.9                         |             |   |  |
| 228                                     | 4/1/2009  |                            |                            |                           |                           |                            | 25.7                         | 26.2                         |             |   |  |
| 229                                     | 4/2/2009  |                            |                            |                           |                           |                            |                              |                              | Zero filter |   |  |
| 230                                     | 4/3/2009  |                            |                            |                           |                           |                            | 63.6                         | 66.4                         |             |   |  |
| 231                                     | 4/4/2009  |                            |                            |                           |                           |                            | 90.4                         | 92.0                         |             |   |  |
| 232                                     | 4/5/2009  |                            |                            |                           |                           |                            | 78.4                         | 77.4                         |             |   |  |
| 233                                     | 4/6/2009  |                            |                            |                           |                           |                            | 31.7                         | 29.9                         |             |   |  |
| 234                                     | 4/7/2009  |                            |                            |                           |                           |                            | 22.2                         | 21.4                         |             |   |  |
| 235                                     | 4/8/2009  |                            |                            |                           |                           |                            | 7.0                          | 4.8                          |             |   |  |
| 236                                     | 4/9/2009  |                            |                            |                           |                           |                            | 9.2                          | 8.3                          |             |   |  |
| 237                                     | 4/10/2009 |                            |                            |                           |                           |                            | 17.3                         | 17.4                         |             |   |  |
| 238                                     | 4/11/2009 |                            |                            |                           |                           |                            | 35.5                         | 38.5                         |             |   |  |
| 239                                     | 4/12/2009 |                            |                            |                           |                           |                            | 124.1                        | 126.7                        |             |   |  |
| 240                                     | 4/13/2009 |                            |                            |                           |                           |                            | 110.7                        | 105.1                        |             |   |  |

**Annex 4**

**Measured values from the field test sites, related to ambient conditions**

| Manufacturer Met One Instruments<br>Type BAM-1020<br>Serial-No. SN 17010 & SN 17011 |           |                            |                            |                           |                           |                            |                              |                              |  |                   |
|---|-----------|----------------------------|----------------------------|---------------------------|---------------------------|----------------------------|------------------------------|------------------------------|--|-------------------|
| PM2.5, ambient air<br>Measured values in µg/m³, ambient cond.                       |           |                            |                            |                           |                           |                            |                              |                              |  |                   |
| No.   | Date      | Ref. 1<br>PM2.5<br>[µg/m³] | Ref. 2<br>PM2.5<br>[µg/m³] | Ref. 1<br>PM10<br>[µg/m³] | Ref. 2<br>PM10<br>[µg/m³] | Ratio<br>PM2.5/PM10<br>[%] | SN 17010<br>PM2.5<br>[µg/m³] | SN 17011<br>PM2.5<br>[µg/m³] | Remark   | Test site         |
| 241   | 8/9/2009  | 38.1                       | 37.7                       |                           |                           |                            |                              | 40.5                         | 17010 shows spikes in measured value and in stability values | Bornheim (Summer) |
| 242   | 8/10/2009 |                            |                            |                           |                           |                            |                              | 29.4                         |  |                   |
| 243   | 8/11/2009 | 12.4                       | 11.9                       |                           |                           |                            |                              | 10.6                         |  |                   |
| 244   | 8/12/2009 | 9.6                        | 10.0                       |                           |                           |                            |                              |                              | Change of PMT for 17010                                      |                   |
| 245   | 8/13/2009 |                            |                            |                           |                           |                            |                              |                              | Zero filter  |                   |
| 246   | 8/14/2009 |                            |                            |                           |                           |                            |                              |                              | Zero filter  |                   |
| 247   | 8/15/2009 |                            |                            |                           |                           |                            | 11.5                         | 10.7                         |  |                   |
| 248   | 8/16/2009 | 16.5                       | 16.7                       | 22.8                      | 22.8                      | 72.8                       | 15.0                         | 13.9                         |  |                   |
| 249   | 8/17/2009 | 15.0                       | 15.0                       | 24.1                      | 23.7                      | 62.7                       | 15.7                         | 14.1                         |  |                   |
| 250   | 8/18/2009 | 12.4                       | 13.0                       | 20.1                      | 19.7                      | 63.7                       | 13.3                         | 13.3                         |  |                   |
| 251   | 8/19/2009 | 16.8                       | 17.2                       | 24.0                      | 24.3                      | 70.3                       | 15.0                         | 13.7                         |  |                   |
| 252   | 8/20/2009 | 19.6                       | 19.4                       | 33.4                      | 32.7                      | 59.1                       | 14.4                         | 11.6                         |  |                   |
| 253   | 8/21/2009 | 8.0                        | 8.2                        | 18.9                      | 18.7                      | 43.0                       | 9.7                          | 8.1                          |  |                   |
| 254   | 8/22/2009 |                            |                            |                           |                           |                            | 10.8                         | 9.6                          |  |                   |
| 255   | 8/23/2009 | 11.7                       | 12.0                       | 17.2                      | 17.6                      | 68.1                       | 10.7                         | 9.1                          |  |                   |
| 256   | 8/24/2009 | 14.3                       | 13.8                       | 19.1                      | 20.4                      | 71.3                       | 12.0                         | 11.3                         |  |                   |
| 257   | 8/25/2009 |                            |                            | 21.4                      | 21.2                      |                            | 15.9                         | 12.9                         | Outlier Ref. PM2.5   |                   |
| 258   | 8/26/2009 |                            |                            |                           |                           |                            | 9.2                          | 7.6                          |  |                   |
| 259   | 8/27/2009 | 8.7                        | 9.1                        | 15.4                      | 16.1                      | 56.3                       | 6.6                          | 4.8                          |  |                   |
| 260   | 8/28/2009 | 8.3                        | 8.0                        | 17.0                      | 16.9                      | 48.1                       | 7.0                          | 4.6                          |  |                   |
| 261   | 8/29/2009 |                            |                            |                           |                           |                            | 7.5                          | 6.0                          |  |                   |
| 262   | 8/30/2009 | 7.3                        | 7.5                        | 16.8                      | 16.8                      | 43.9                       | 7.8                          | 6.3                          |  |                   |
| 263   | 8/31/2009 | 12.3                       | 11.9                       | 22.3                      | 21.0                      | 55.9                       | 9.1                          | 8.2                          |  |                   |
| 264   | 9/1/2009  | 11.3                       | 11.3                       | 18.1                      | 18.4                      | 62.0                       | 9.9                          | 8.6                          |  |                   |
| 265   | 9/2/2009  | 7.9                        | 8.0                        | 13.3                      | 13.7                      | 58.9                       |                              | 6.8                          | 17010, Filter tape crack                                     |                   |
| 266   | 9/3/2009  | 5.3                        | 5.3                        | 8.0                       | 7.2                       | 69.1                       |                              | 4.4                          | 17010, Filter tape crack                                     |                   |
| 267   | 9/4/2009  | 5.4                        | 5.4                        | 8.9                       | 9.2                       | 60.0                       | 4.5                          | 5.6                          |  |                   |
| 268   | 9/5/2009  |                            |                            |                           |                           |                            | 7.9                          | 7.2                          |  |                   |
| 269   | 9/6/2009  | 6.7                        | 6.5                        | 10.6                      | 10.6                      | 62.3                       | 6.9                          | 7.7                          |  |                   |
| 270   | 9/7/2009  | 11.4                       | 11.9                       | 18.5                      | 18.5                      | 62.8                       | 10.5                         | 11.5                         |  |                   |



**Annex 4**
**Measured values from the field test sites, related to ambient conditions**

| <b>Manufacturer</b> Met One Instruments |           |   |   |  |   |                            | PM2.5, ambient air                                   |   |             |                      |
|---|-----------|---|---|--|---|----------------------------|--|---|-------------|----------------------|
| <b>Type</b> BAM-1020                    |           |   |   |  |   |                            | Measured values in µg/m <sup>3</sup> , ambient cond. |   |             |                      |
| <b>Serial-No.</b> SN 17010 & SN 17011   |           |   |   |  |   |                            |  |   |             |                      |
| No.                                     | Date      | Ref. 1<br>PM2.5<br>[µg/m <sup>3</sup> ] | Ref. 2<br>PM2.5<br>[µg/m <sup>3</sup> ] | Ref. 1<br>PM10<br>[µg/m <sup>3</sup> ] | Ref. 2.<br>PM10<br>[µg/m <sup>3</sup> ] | Ratio<br>PM2.5/PM10<br>[%] | SN 17010<br>PM2.5<br>[µg/m <sup>3</sup> ]            | SN 17011<br>PM2.5<br>[µg/m <sup>3</sup> ] | Remark      | Test site            |
| 271                                     | 9/8/2009  | 17.0                                    | 16.9                                    | 25.2                                   | 25.0                                    | 67.5                       | 15.2   | 16.5                                      | Zero filter | Bornheim<br>(Summer) |
| 272                                     | 9/9/2009  | 19.4                                    | 19.2                                    | 38.2                                   | 37.5                                    | 51.0                       | 20.0   | 20.1                                      |             |                      |
| 273                                     | 9/10/2009 | 10.2                                    | 9.6                                     | 22.3                                   | 21.9                                    | 44.7                       | 12.4   | 14.8                                      |             |                      |
| 274                                     | 9/11/2009 | 9.1                                     | 9.4                                     | 21.0                                   | 20.7                                    | 44.4                       | 9.2  | 11.6                                      |             |                      |
| 275                                     | 9/12/2009 |   |   |  |   |                            | 11.4   | 11.6                                      |             |                      |
| 276                                     | 9/13/2009 | 5.4                                     | 5.6                                     | 12.9                                   | 13.8                                    | 41.5                       | 6.3  | 6.2                                       |             |                      |
| 277                                     | 9/14/2009 |   |   |  |   |                            |  |   |             |                      |
| 278                                     | 9/15/2009 | 12.6                                    | 13.0                                    | 17.2                                   | 16.8                                    | 75.0                       | 15.0   | 16.2                                      |             |                      |
| 279                                     | 9/16/2009 | 25.6                                    | 25.9                                    | 34.5                                   | 33.3                                    | 76.0                       | 27.2   | 30.8                                      |             |                      |
| 280                                     | 9/17/2009 | 13.6                                    | 13.8                                    | 20.8                                   | 20.2                                    | 66.8                       | 14.3   | 17.2                                      |             |                      |
| 281                                     | 9/18/2009 | 18.7                                    | 19.0                                    | 24.8                                   | 25.6                                    | 74.8                       | 19.7   | 19.9                                      |             |                      |
| 282                                     | 9/19/2009 |   |   |  |   |                            | 23.1   | 24.7                                      |             |                      |
| 283                                     | 9/20/2009 | 36.7                                    | 37.1                                    | 45.0                                   | 45.2                                    | 81.8                       | 39.6   | 41.3                                      |             |                      |
| 284                                     | 9/21/2009 | 18.2                                    | 19.0                                    | 28.7                                   | 29.1                                    | 64.3                       | 23.0   | 25.3                                      |             |                      |
| 285                                     | 9/22/2009 | 14.9                                    | 15.0                                    | 27.2                                   | 28.1                                    | 54.1                       | 17.2   | 17.9                                      |             |                      |
| 286                                     | 9/23/2009 | 12.9                                    | 12.7                                    | 26.8                                   | 27.0                                    | 47.5                       | 13.2   | 16.4                                      |             |                      |
| 287                                     | 9/24/2009 | 14.9                                    | 14.5                                    | 23.0                                   | 22.8                                    | 64.0                       | 14.7   | 16.7                                      |             |                      |
| 288                                     | 9/25/2009 | 16.3                                    | 16.1                                    | 28.6                                   | 27.4                                    | 57.9                       | 15.6   | 16.9                                      |             |                      |
| 289                                     | 9/26/2009 |   |   |  |   |                            | 14.8   | 15.3                                      |             |                      |
| 290                                     | 9/27/2009 | 26.0                                    | 25.7                                    | 34.9                                   | 35.8                                    | 73.0                       | 24.0   | 24.3                                      |             |                      |
| 291                                     | 9/28/2009 | 28.8                                    | 29.5                                    | 44.4                                   | 45.3                                    | 65.1                       | 29.0   | 30.8                                      |             |                      |
| 292                                     | 9/29/2009 | 18.0                                    | 18.3                                    | 28.0                                   | 27.8                                    | 65.1                       | 18.5   | 20.0                                      |             |                      |
| 293                                     | 9/30/2009 | 19.1                                    | 19.7                                    | 25.1                                   | 25.3                                    | 77.2                       | 19.2   | 21.1                                      |             |                      |
| 294                                     | 10/1/2009 | 9.6                                     | 8.9                                     | 18.5                                   | 18.8                                    | 49.5                       | 9.7  | 9.8                                       |             |                      |
| 295                                     | 10/2/2009 | 12.0                                    | 12.0                                    | 25.9                                   | 26.1                                    | 46.0                       | 10.3   | 11.1                                      |             |                      |
| 296                                     | 10/3/2009 |   |   |  |   |                            | 5.9  | 7.7                                       |             |                      |
| 297                                     | 10/4/2009 | 5.4                                     | 6.0                                     | 10.6                                   | 11.0                                    | 52.6                       | 5.5  | 4.3                                       |             |                      |
| 298                                     | 10/5/2009 | 8.2                                     | 8.4                                     | 12.5                                   | 14.0                                    | 62.7                       | 7.4  | 9.3                                       |             |                      |
| 299                                     | 10/6/2009 | 12.8                                    | 12.9                                    | 17.5                                   | 18.8                                    | 70.7                       | 13.1   | 13.9                                      |             |                      |
| 300                                     | 10/7/2009 | 8.7                                     | 8.5                                     | 14.0                                   | 14.3                                    | 60.9                       | 9.1  | 8.7                                       |             |                      |

Report on the suitability test of the ambient air quality measurement system  
BAM-1020 with PM2.5 pre-separator of the company Met One Instruments,  
Inc. for the component suspended particulate matter PM2.5,  
Report-No.: 936/21209919/A

**Annex 4**

**Measured values from the field test sites, related to ambient conditions**

| Manufacturer Met One Instruments<br>Type BAM-1020<br>Serial-No. SN 17010 & SN 17011 |            |                            |                            |                           |                           |                            |                              |                              |                    | PM2.5, ambient air<br>Measured values in µg/m³, ambient cond. |  |
|---|------------|----------------------------|----------------------------|---------------------------|---------------------------|----------------------------|------------------------------|------------------------------|--------------------|---|--|
| No.   | Date       | Ref. 1<br>PM2.5<br>[µg/m³] | Ref. 2<br>PM2.5<br>[µg/m³] | Ref. 1<br>PM10<br>[µg/m³] | Ref. 2<br>PM10<br>[µg/m³] | Ratio<br>PM2.5/PM10<br>[%] | SN 17010<br>PM2.5<br>[µg/m³] | SN 17011<br>PM2.5<br>[µg/m³] | Remark             | Test site   |  |
| 301   | 10/8/2009  | 11.2                       | 10.7                       | 16.1                      | 16.7                      | 66.9                       | 12.9                         | 12.8                         |                    | Bornheim<br>(Summer)  |  |
| 302   | 10/9/2009  | 9.1                        | 8.5                        | 15.6                      | 15.6                      | 56.4                       | 8.1                          | 9.3                          |                    |   |  |
| 303   | 10/10/2009 |                            |                            |                           |                           |                            | 10.0                         | 10.1                         |                    |   |  |
| 304   | 10/11/2009 | 5.8                        | 6.6                        | 11.6                      | 12.0                      | 52.4                       | 5.1                          | 8.0                          |                    |   |  |
| 305   | 10/12/2009 | 4.8                        | 4.2                        | 9.9                       | 9.9                       | 45.4                       | 5.0                          | 6.6                          |                    |   |  |
| 306   | 10/13/2009 | 6.2                        | 6.3                        | 12.5                      | 12.5                      | 50.0                       | 6.5                          | 6.8                          |                    |   |  |
| 307   | 10/14/2009 | 11.2                       | 10.3                       | 15.4                      | 15.6                      | 69.6                       | 10.1                         | 11.8                         |                    |   |  |
| 308   | 10/15/2009 | 11.2                       | 10.2                       | 18.0                      | 17.8                      | 59.8                       | 8.9                          | 10.7                         |                    |   |  |
| 309   | 10/16/2009 | 6.5                        | 6.3                        | 16.1                      | 15.8                      | 40.3                       | 5.7                          | 8.5                          |                    |   |  |
| 310   | 10/17/2009 |                            |                            |                           |                           |                            | 8.4                          | 8.5                          |                    |   |  |
| 311   | 10/18/2009 | 11.3                       | 11.3                       | 18.4                      | 18.6                      | 60.9                       | 10.4                         | 10.4                         |                    |   |  |
| 312   | 10/19/2009 | 12.8                       | 12.8                       | 19.6                      | 19.6                      | 65.1                       | 11.9                         | 12.5                         |                    |   |  |
| 313   | 10/20/2009 | 15.6                       | 14.9                       |                           |                           |                            | 13.0                         | 14.2                         | Outlier Ref. PM10  |   |  |
| 314   | 10/21/2009 | 20.8                       | 21.2                       | 27.6                      | 28.1                      | 75.6                       | 18.4                         | 19.7                         |                    |   |  |
| 315   | 10/22/2009 |                            |                            | 31.7                      | 32.3                      |                            | 23.3                         | 25.0                         | Outlier Ref. PM2.5 |   |  |
| 316   | 12/9/2009  | 11.3                       | 11.6                       | 27.5                      | 27.5                      | 41.6                       | 10.1                         | 10.5                         |                    | Teddington<br>(Winter)  |  |
| 317   | 12/10/2009 | 16.4                       | 16.2                       | 25.4                      | 25.4                      | 64.2                       | 16.1                         | 17.4                         |                    |   |  |
| 318   | 12/11/2009 | 11.8                       | 11.7                       | 20.3                      | 20.2                      | 57.9                       | 10.4                         | 11.4                         |                    |   |  |
| 319   | 12/12/2009 | 6.4                        | 6.5                        | 13.5                      | 13.6                      | 47.6                       | 6.2                          | 6.9                          |                    |   |  |
| 320   | 12/13/2009 | 8.6                        | 9.1                        | 13.4                      | 13.9                      | 65.1                       | 8.4                          | 8.3                          |                    |   |  |
| 321   | 12/14/2009 | 27.9                       | 28.3                       | 35.3                      | 35.3                      | 79.6                       | 26.9                         | 27.4                         |                    |   |  |
| 322   | 12/15/2009 | 39.8                       | 38.8                       | 47.6                      | 47.4                      | 82.8                       | 39.9                         |                              |                    |   |  |
| 323   | 12/16/2009 | 24.9                       | 24.5                       | 30.0                      | 30.3                      | 82.0                       | 24.0                         |                              |                    |   |  |
| 324   | 12/17/2009 | 5.7                        | 5.6                        | 10.2                      | 10.1                      | 55.7                       | 6.3                          | 6.4                          |                    |   |  |
| 325   | 12/18/2009 | 11.6                       | 11.9                       | 16.9                      | 17.0                      | 69.3                       | 10.1                         | 11.3                         |                    |   |  |
| 326   | 12/19/2009 | 10.3                       | 11.0                       | 15.4                      | 14.9                      | 70.4                       | 11.3                         | 12.0                         |                    |   |  |
| 327   | 12/20/2009 | 6.2                        | 6.4                        | 11.1                      | 11.0                      | 56.9                       | 6.6                          | 7.9                          |                    |   |  |
| 328   | 12/21/2009 | 17.7                       | 17.7                       | 20.2                      | 20.4                      | 87.2                       | 17.6                         | 17.9                         |                    |   |  |
| 329   | 12/22/2009 | 29.4                       | 28.9                       |                           |                           |                            | 31.7                         | 31.9                         | Outlier Ref. PM10  |   |  |
| 330   | 12/23/2009 |                            |                            |                           |                           |                            | 14.7                         | 15.9                         |                    |   |  |

**Annex 4**
**Measured values from the field test sites, related to ambient conditions**

| <b>Manufacturer</b> Met One Instruments |            |   |   |  |  |                            | PM2.5, ambient air                                   |   |                    |                        |
|---|------------|---|---|--|--|----------------------------|--|---|--------------------|------------------------|
| <b>Type</b> BAM-1020                    |            |   |   |  |  |                            | Measured values in µg/m <sup>3</sup> , ambient cond. |   |                    |                        |
| <b>Serial-No.</b> SN 17010 & SN 17011   |            |   |   |  |  |                            |  |   |                    |                        |
| No.                                     | Date       | Ref. 1<br>PM2.5<br>[µg/m <sup>3</sup> ] | Ref. 2<br>PM2.5<br>[µg/m <sup>3</sup> ] | Ref. 1<br>PM10<br>[µg/m <sup>3</sup> ] | Ref. 2<br>PM10<br>[µg/m <sup>3</sup> ] | Ratio<br>PM2.5/PM10<br>[%] | SN 17010<br>PM2.5<br>[µg/m <sup>3</sup> ]            | SN 17011<br>PM2.5<br>[µg/m <sup>3</sup> ] | Remark             | Test site              |
| 331                                     | 12/24/2009 |   |   |  |  |                            | 16.5   | 17.5                                      |                    | Teddington<br>(Winter) |
| 332                                     | 12/25/2009 |   |   |  |  |                            | 9.5  | 9.7                                       |                    |                        |
| 333                                     | 12/26/2009 |   |   |  |  |                            | 3.3  | 3.2                                       |                    |                        |
| 334                                     | 12/27/2009 |   |   |  |  |                            | 4.6  | 5.7                                       |                    |                        |
| 335                                     | 12/28/2009 |   |   |  |  |                            | 17.8   | 19.2                                      |                    |                        |
| 336                                     | 12/29/2009 |   |   |  |  |                            | 8.7  | 9.9                                       |                    |                        |
| 337                                     | 12/30/2009 |   |   |  |  |                            | 8.8  | 9.3                                       |                    |                        |
| 338                                     | 12/31/2009 | 6.0                                     | 6.5                                     |  |  |                            | 6.5  | 6.7                                       |                    |                        |
| 339                                     | 1/1/2010   |   |   |  |  |                            | 13.8   | 13.7                                      |                    |                        |
| 340                                     | 1/2/2010   |   |   |  |  |                            | 11.6   | 12.5                                      |                    |                        |
| 341                                     | 1/3/2010   |   |   |  |  |                            | 16.4   | 17.7                                      |                    |                        |
| 342                                     | 1/4/2010   |   |   |  |  |                            |  |   | Zero filter        |                        |
| 343                                     | 1/5/2010   | 15.6                                    | 15.5                                    |  |  |                            | 15.5   | 16.4                                      |                    |                        |
| 344                                     | 1/6/2010   |   |   | 19.2                                   | 19.3                                   |                            | 13.0   | 13.9                                      | Outlier Ref. PM2.5 |                        |
| 345                                     | 1/7/2010   | 15.3                                    | 15.7                                    | 19.4                                   | 20.1                                   | 78.4                       | 14.6   | 15.7                                      |                    |                        |
| 346                                     | 1/8/2010   | 14.6                                    | 14.9                                    | 18.3                                   | 18.4                                   | 80.3                       | 12.9   | 15.2                                      |                    |                        |
| 347                                     | 1/9/2010   | 7.1                                     | 6.9                                     | 14.6                                   | 14.9                                   | 47.4                       | 8.0  | 7.9                                       |                    |                        |
| 348                                     | 1/10/2010  | 16.0                                    | 16.1                                    | 19.5                                   | 19.2                                   | 82.9                       | 14.4   | 15.1                                      |                    |                        |
| 349                                     | 1/11/2010  | 45.7                                    | 46.2                                    | 51.8                                   | 51.3                                   | 89.1                       | 43.9   | 45.3                                      |                    |                        |
| 350                                     | 1/12/2010  | 43.2                                    | 43.6                                    | 48.1                                   | 48.0                                   | 90.4                       | 43.0   | 45.2                                      |                    |                        |
| 351                                     | 1/13/2010  | 48.0                                    | 48.3                                    | 53.4                                   | 53.0                                   | 90.6                       | 46.8   | 47.9                                      |                    |                        |
| 352                                     | 1/14/2010  | 14.1                                    | 14.4                                    | 16.2                                   | 16.3                                   | 87.5                       | 14.6   | 15.6                                      |                    |                        |
| 353                                     | 1/15/2010  | 14.6                                    | 14.4                                    | 26.9                                   | 27.1                                   | 53.6                       | 11.9   | 13.2                                      |                    |                        |
| 354                                     | 1/16/2010  | 6.5                                     | 6.1                                     | 13.5                                   | 13.6                                   | 46.1                       | 7.5  | 8.1                                       |                    |                        |
| 355                                     | 1/17/2010  | 11.0                                    | 10.5                                    | 20.6                                   | 20.6                                   | 52.3                       | 10.0   | 10.4                                      |                    |                        |
| 356                                     | 1/18/2010  | 21.0                                    | 20.4                                    | 27.1                                   | 26.9                                   | 76.7                       | 18.5   | 21.0                                      |                    |                        |
| 357                                     | 1/19/2010  | 20.4                                    | 20.2                                    | 26.5                                   | 26.6                                   | 76.4                       | 17.7   | 19.6                                      |                    |                        |
| 358                                     | 1/20/2010  | 26.6                                    | 27.0                                    | 32.0                                   | 31.9                                   | 83.8                       | 25.1   | 25.8                                      |                    |                        |
| 359                                     | 1/21/2010  | 20.5                                    | 20.9                                    | 27.5                                   | 27.9                                   | 75.0                       | 20.0   | 20.0                                      |                    |                        |
| 360                                     | 1/22/2010  | 7.8                                     | 7.6                                     | 9.7                                    | 9.8                                    | 78.5                       | 7.3  | 8.2                                       |                    |                        |

Report on the suitability test of the ambient air quality measurement system  
BAM-1020 with PM2.5 pre-separator of the company Met One Instruments,  
Inc. for the component suspended particulate matter PM2.5,  
Report-No.: 936/21209919/A

**Annex 4**

**Measured values from the field test sites, related to ambient conditions**

| <b>Manufacturer</b> Met One Instruments |           |                            |                            |                           |                            |                            | PM2.5, ambient air<br>Measured values in µg/m³, ambient cond. |                              |        |                        |
|---|-----------|----------------------------|----------------------------|---------------------------|----------------------------|----------------------------|---|------------------------------|--------|------------------------|
| <b>Type</b> BAM-1020                    |           |                            |                            |                           |                            |                            |   |                              |        |                        |
| <b>Serial-No.</b> SN 17010 & SN 17011   |           |                            |                            |                           |                            |                            |   |                              |        |                        |
| No.                                     | Date      | Ref. 1<br>PM2.5<br>[µg/m³] | Ref. 2<br>PM2.5<br>[µg/m³] | Ref. 1<br>PM10<br>[µg/m³] | Ref. 2.<br>PM10<br>[µg/m³] | Ratio<br>PM2.5/PM10<br>[%] | SN 17010<br>PM2.5<br>[µg/m³]                                  | SN 17011<br>PM2.5<br>[µg/m³] | Remark | Test site              |
| 361                                     | 1/23/2010 | 21.0                       | 20.9                       | 25.8                      | 25.1                       | 82.3                       | 19.5  | 19.8                         |        | Teddington<br>(Winter) |
| 362                                     | 1/24/2010 | 16.2                       | 15.9                       | 20.7                      | 20.3                       | 78.4                       | 14.0  | 16.5                         |        |                        |
| 363                                     | 1/25/2010 | 36.1                       | 35.8                       | 42.0                      | 42.4                       | 85.1                       | 35.6  | 38.9                         |        |                        |
| 364                                     | 1/26/2010 | 50.7                       | 51.1                       | 60.4                      | 60.4                       | 84.2                       | 47.4  | 50.8                         |        |                        |
| 365                                     | 1/27/2010 | 27.1                       | 27.3                       | 38.9                      | 39.1                       | 69.7                       | 24.0  | 26.4                         |        |                        |
| 366                                     | 1/28/2010 | 8.3                        | 8.0                        | 13.9                      | 14.1                       | 58.3                       | 8.2   | 9.2                          |        |                        |
| 367                                     | 1/29/2010 | 5.7                        | 6.0                        | 9.4                       | 9.6                        | 61.5                       | 6.3   | 6.8                          |        |                        |
| 368                                     | 1/30/2010 | 12.4                       | 12.5                       | 17.6                      | 17.6                       | 70.7                       | 11.5  | 13.7                         |        |                        |
| 369                                     | 1/31/2010 | 12.2                       | 13.0                       | 17.3                      | 16.9                       | 73.5                       | 11.7  | 14.2                         |        |                        |
| 370                                     | 2/1/2010  | 8.4                        | 8.3                        | 14.7                      | 14.4                       | 57.5                       | 8.1   | 9.6                          |        |                        |
| 371                                     | 2/2/2010  | 8.3                        | 8.3                        | 12.0                      | 11.7                       | 70.0                       | 7.7   | 10.1                         |        |                        |
| 372                                     | 2/3/2010  | 9.4                        | 9.3                        | 19.2                      | 19.2                       | 48.6                       | 9.0   | 11.3                         |        |                        |
| 373                                     | 2/4/2010  | 12.0                       | 12.4                       | 19.7                      | 19.8                       | 61.7                       | 11.5  | 13.4                         |        |                        |

**Annex 5**
**Ambient conditions at the field test sites**

| No. | Date      | Test site              | Ambient temperature<br>[°C] | Ambient pressure<br>[hPa] | Rel. humidity<br>[%] | Wind velocity<br>[m/s] | Wind direction<br>[°] | Precipitation<br>[mm] |
|-----|-----------|------------------------|-----------------------------|---------------------------|----------------------|------------------------|-----------------------|-----------------------|
| 1   | 7/24/2008 | Teddington<br>(Summer) | No weather data available   |                           |                      |                        |                       |                       |
| 2   | 7/25/2008 |                        |                             |                           |                      |                        |                       |                       |
| 3   | 7/26/2008 |                        |                             |                           |                      |                        |                       |                       |
| 4   | 7/27/2008 |                        |                             |                           |                      |                        |                       |                       |
| 5   | 7/28/2008 |                        |                             |                           |                      |                        |                       |                       |
| 6   | 7/29/2008 |                        |                             |                           |                      |                        |                       |                       |
| 7   | 7/30/2008 |                        |                             |                           |                      |                        |                       |                       |
| 8   | 7/31/2008 |                        |                             |                           |                      |                        |                       |                       |
| 9   | 8/1/2008  |                        |                             |                           |                      |                        |                       |                       |
| 10  | 8/2/2008  |                        |                             |                           |                      |                        |                       |                       |
| 11  | 8/3/2008  |                        |                             |                           |                      |                        |                       |                       |
| 12  | 8/4/2008  |                        |                             |                           |                      |                        |                       |                       |
| 13  | 8/5/2008  |                        |                             |                           |                      |                        |                       |                       |
| 14  | 8/6/2008  |                        |                             |                           |                      |                        |                       |                       |
| 15  | 8/7/2008  |                        |                             |                           |                      |                        |                       |                       |
| 16  | 8/8/2008  |                        |                             |                           |                      |                        |                       |                       |
| 17  | 8/9/2008  |                        |                             |                           |                      |                        |                       |                       |
| 18  | 8/10/2008 |                        |                             |                           |                      |                        |                       |                       |
| 19  | 8/11/2008 |                        |                             |                           |                      |                        |                       |                       |
| 20  | 8/12/2008 |                        |                             |                           |                      |                        |                       |                       |
| 21  | 8/13/2008 |                        |                             |                           |                      |                        |                       |                       |
| 22  | 8/14/2008 |                        |                             |                           |                      |                        |                       |                       |
| 23  | 8/15/2008 |                        |                             |                           |                      |                        |                       |                       |
| 24  | 8/16/2008 |                        |                             |                           |                      |                        |                       |                       |
| 25  | 8/17/2008 |                        |                             |                           |                      |                        |                       |                       |
| 26  | 8/18/2008 |                        |                             |                           |                      |                        |                       |                       |
| 27  | 8/19/2008 |                        |                             |                           |                      |                        |                       |                       |
| 28  | 8/20/2008 |                        |                             |                           |                      |                        |                       |                       |
| 29  | 8/21/2008 |                        |                             |                           |                      |                        |                       |                       |
| 30  | 8/22/2008 |                        |                             |                           |                      |                        |                       |                       |

Report on the suitability test of the ambient air quality measurement system  
 BAM-1020 with PM2.5 pre-separator of the company Met One Instruments,  
 Inc. for the component suspended particulate matter PM2.5,  
 Report-No.: 936/21209919/A

**Annex 5**

**Ambient conditions at the field test sites**

| No. | Date      | Test site              | Ambient temperature<br>[°C] | Ambient pressure<br>[hPa] | Rel. humidity<br>[%] | Wind velocity<br>[m/s] | Wind direction<br>[°] | Precipitation<br>[mm] |  |
|-----|-----------|------------------------|-----------------------------|---------------------------|----------------------|------------------------|-----------------------|-----------------------|--|
| 31  | 8/23/2008 | Teddington<br>(Summer) |                             |                           |                      |                        |                       |                       |  |
| 32  | 8/24/2008 |                        |                             |                           |                      |                        |                       |                       |  |
| 33  | 8/25/2008 |                        |                             |                           |                      |                        |                       |                       |  |
| 34  | 8/26/2008 |                        |                             |                           |                      |                        |                       |                       |  |
| 35  | 8/27/2008 |                        |                             |                           |                      |                        |                       |                       |  |
| 36  | 8/28/2008 |                        |                             |                           |                      |                        |                       |                       |  |
| 37  | 8/29/2008 |                        |                             |                           |                      |                        |                       |                       |  |
| 38  | 8/30/2008 |                        |                             |                           |                      |                        |                       |                       |  |
| 39  | 8/31/2008 |                        |                             |                           |                      |                        |                       |                       |  |
| 40  | 9/1/2008  |                        |                             |                           |                      |                        |                       |                       |  |
| 41  | 9/2/2008  |                        |                             |                           |                      |                        |                       |                       |  |
| 42  | 9/3/2008  |                        |                             |                           |                      |                        |                       |                       |  |
| 43  | 9/4/2008  |                        |                             |                           |                      |                        |                       |                       |  |
| 44  | 9/5/2008  |                        |                             |                           |                      |                        |                       |                       |  |
| 45  | 9/6/2008  |                        |                             |                           |                      |                        |                       |                       |  |
| 46  | 9/7/2008  |                        |                             |                           |                      |                        |                       |                       |  |
| 47  | 9/8/2008  |                        |                             |                           |                      |                        |                       |                       |  |
| 48  | 9/9/2008  |                        |                             |                           |                      |                        |                       |                       |  |
| 49  | 9/10/2008 |                        |                             |                           |                      |                        |                       |                       |  |
| 50  | 9/11/2008 |                        |                             |                           |                      |                        |                       |                       |  |
| 51  | 9/12/2008 |                        |                             |                           |                      |                        |                       |                       |  |
| 52  | 9/13/2008 |                        |                             |                           |                      |                        |                       |                       |  |
| 53  | 9/14/2008 |                        |                             |                           |                      |                        |                       |                       |  |
| 54  | 9/15/2008 |                        |                             |                           |                      |                        |                       |                       |  |
| 55  | 9/16/2008 |                        |                             |                           |                      |                        |                       |                       |  |
| 56  | 9/17/2008 |                        |                             | 14.5                      | 1005                 | 68.1                   | 0.6                   | 153                   |  |
| 57  | 9/18/2008 |                        |                             | 11.6                      | 1007                 | 72.0                   | 0.5                   | 195                   |  |
| 58  | 9/19/2008 |                        |                             | 12.8                      | 1012                 | 70.1                   | 0.3                   | 170                   |  |
| 59  | 9/20/2008 |                        |                             | 13.1                      | 1011                 | 70.5                   | 0.5                   | 116                   |  |
| 60  | 9/21/2008 |                        |                             | 13.2                      | 1008                 | 70.0                   | 0.6                   | 168                   |  |

No weather data available

**Annex 5**

**Ambient conditions at the field test sites**

| No. | Date       | Test site              | Ambient temperature<br>[°C] | Ambient pressure<br>[hPa] | Rel. humidity<br>[%] | Wind velocity<br>[m/s] | Wind direction<br>[°] | Precipitation<br>[mm] |
|-----|------------|------------------------|-----------------------------|---------------------------|----------------------|------------------------|-----------------------|-----------------------|
| 61  | 9/22/2008  | Teddington<br>(Summer) | 14.8                        | 1006                      | 76.5                 | 1.1                    | 211                   |                       |
| 62  | 9/23/2008  |                        | 14.4                        | 1006                      | 76.0                 | 1.8                    | 228                   |                       |
| 63  | 9/24/2008  |                        | 14.8                        | 1010                      | 81.9                 | 0.8                    | 168                   |                       |
| 64  | 9/25/2008  |                        | 13.3                        | 1016                      | 74.7                 | 0.7                    | 89                    |                       |
| 65  | 9/26/2008  |                        | 13.4                        | 1016                      | 75.6                 | 0.7                    | 146                   |                       |
| 66  | 9/27/2008  |                        | 12.0                        | 1011                      | 80.6                 | 0.1                    | 206                   |                       |
| 67  | 9/28/2008  |                        | 13.9                        | 1005                      | 70.7                 | 0.2                    | 300                   |                       |
| 68  | 9/29/2008  |                        | 14.0                        | 997                       | 71.7                 | 0.3                    | 235                   |                       |
| 69  | 9/30/2008  |                        | 13.7                        | 984                       | 83.8                 | 0.4                    | 210                   |                       |
| 70  | 10/1/2008  |                        | 10.4                        | 985                       | 71.9                 | 0.4                    | 232                   |                       |
| 71  | 10/2/2008  |                        | 9.5                         | 988                       | 69.7                 | 0.7                    | 272                   |                       |
| 72  | 10/3/2008  |                        | 9.3                         | 999                       | 64.0                 | 0.6                    | 279                   |                       |
| 73  | 10/4/2008  |                        | 14.1                        | 985                       | 87.0                 | 1.1                    | 179                   |                       |
| 74  | 10/5/2008  |                        | 10.1                        | 987                       | 88.7                 | 0.6                    | 259                   |                       |
| 75  | 10/6/2008  |                        | 14.8                        | 991                       | 87.0                 | 0.9                    | 161                   |                       |
| 76  | 10/7/2008  |                        | 12.7                        | 991                       | 89.6                 | 0.6                    | 219                   |                       |
| 77  | 10/8/2008  |                        | 9.6                         | 1008                      | 80.6                 | 0.2                    | 276                   |                       |
| 78  | 10/9/2008  |                        | 13.3                        | 1013                      | 80.2                 | 0.3                    | 184                   |                       |
| 79  | 10/10/2008 |                        | 12.0                        | 1009                      | 84.4                 | 0.4                    | 210                   |                       |
| 80  | 10/11/2008 |                        | 12.8                        | 1007                      | 85.9                 | 0.2                    | 198                   |                       |
| 81  | 10/12/2008 |                        | 15.4                        | 1001                      | 86.5                 | 0.3                    | 206                   |                       |
| 82  | 10/13/2008 |                        | 12.5                        | 1001                      | 90.9                 | 0.1                    | 209                   |                       |
| 83  | 10/14/2008 |                        | 14.4                        | 998                       | 90.5                 | 0.3                    | 192                   |                       |
| 84  | 10/15/2008 |                        | 12.1                        | 994                       | 86.8                 | 0.3                    | 255                   |                       |
| 85  | 10/16/2008 |                        | 8.2                         | 1001                      | 78.7                 | 0.4                    | 241                   |                       |
| 86  | 10/17/2008 |                        | 9.0                         | 1002                      | 83.8                 | 0.0                    | 229                   |                       |
| 87  | 10/18/2008 |                        | 10.6                        | 1001                      | 83.3                 | 0.1                    | 213                   |                       |
| 88  | 10/19/2008 |                        | 14.0                        | 995                       | 76.3                 | 0.8                    | 192                   |                       |
| 89  | 10/20/2008 |                        | 11.2                        | 989                       | 90.2                 | 0.4                    | 203                   |                       |
| 90  | 10/21/2008 |                        | 6.7                         | 999                       | 80.5                 | 0.2                    | 214                   |                       |

Report on the suitability test of the ambient air quality measurement system  
BAM-1020 with PM2.5 pre-separator of the company Met One Instruments,  
Inc. for the component suspended particulate matter PM2.5,  
Report-No.: 936/21209919/A

**Annex 5**

**Ambient conditions at the field test sites**

| No. | Date       | Test site                 | Ambient temperature<br>[°C] | Ambient pressure<br>[hPa] | Rel. humidity<br>[%] | Wind velocity<br>[m/s] | Wind direction<br>[°] | Precipitation<br>[mm] |  |
|-----|------------|---------------------------|-----------------------------|---------------------------|----------------------|------------------------|-----------------------|-----------------------|--|
| 91  | 10/22/2008 | Teddington<br>(Summer)    | 9.4                         | 1006                      | 80.9                 | 0.2                    | 226                   |                       |  |
| 92  | 10/23/2008 |                           | 13.6                        | 1000                      | 79.8                 | 1.0                    | 195                   |                       |  |
| 93  | 10/24/2008 |                           | 6.5                         | 1011                      | 85.1                 | 0.2                    | 250                   |                       |  |
| 94  | 10/25/2008 |                           | 14.1                        | 1002                      | 81.8                 | 0.9                    | 194                   |                       |  |
| 95  | 10/26/2008 |                           | 9.2                         | 995                       | 95.0                 | 0.0                    | 227                   |                       |  |
| 96  | 10/27/2008 |                           | 4.2                         | 994                       | 85.6                 | 0.1                    | 285                   |                       |  |
| 97  | 10/28/2008 |                           | 4.3                         | 994                       | 81.7                 | 0.5                    | 253                   |                       |  |
| 98  | 10/29/2008 |                           | 4.3                         | 984                       | 77.8                 | 0.4                    | 153                   |                       |  |
| 99  | 10/30/2008 |                           | 5.3                         | 985                       | 79.6                 | 1.1                    | 161                   |                       |  |
| 100 | 10/31/2008 |                           | 5.7                         | 992                       | 80.1                 | 0.9                    | 245                   |                       |  |
| 101 | 11/1/2008  | 8.8                       | 989                         | 91.5                      | 1.2                  | 233                    |                       |                       |  |
| 102 | 11/2/2008  | 10.1                      | 997                         | 88.9                      | 0.8                  | 224                    |                       |                       |  |
| 103 | 11/3/2008  | 10.6                      | 998                         | 93.6                      | 0.9                  | 151                    |                       |                       |  |
| 104 | 11/4/2008  | 11.4                      | 1001                        | 86.2                      | 0.8                  | 179                    |                       |                       |  |
| 105 | 11/5/2008  | 10.5                      | 998                         | 92.6                      | 0.5                  | 284                    |                       |                       |  |
| 106 | 11/6/2008  | 10.5                      | 992                         | 90.7                      | 0.4                  | 161                    |                       |                       |  |
| 107 | 11/7/2008  | No weather data available |                             |                           |                      |                        |                       |                       |  |
| 108 | 11/8/2008  | No weather data available |                             |                           |                      |                        |                       |                       |  |
| 109 | 11/9/2008  | No weather data available |                             |                           |                      |                        |                       |                       |  |
| 110 | 12/4/2008  | Cologne<br>(Winter)       | 4.4                         | 980                       | 77.0                 | 3.7                    | 61                    | 4.5                   |  |
| 111 | 12/5/2008  |                           | 5.6                         | 988                       | 76.4                 | 1.7                    | 109                   | 12.1                  |  |
| 112 | 12/6/2008  |                           | 5.1                         | 1008                      | 81.1                 | 1.7                    | 150                   | 3.6                   |  |
| 113 | 12/7/2008  |                           | 2.0                         | 1021                      | 82.1                 | 0.1                    | 150                   | 0.3                   |  |
| 114 | 12/8/2008  |                           | 0.3                         | 1013                      | 80.5                 | 1.1                    | 186                   | 0.3                   |  |
| 115 | 12/9/2008  |                           | 1.3                         | 1006                      | 82.4                 | 0.3                    | 124                   | 6.5                   |  |
| 116 | 12/10/2008 |                           | 1.3                         | 1005                      | 81.3                 | 0.2                    | 180                   | 2.1                   |  |
| 117 | 12/11/2008 |                           | 0.0                         | 1007                      | 81.6                 | 0.5                    | 244                   | 0.0                   |  |
| 118 | 12/12/2008 |                           | -0.5                        | 1009                      | 74.3                 | 4.4                    | 108                   | 0.0                   |  |
| 119 | 12/13/2008 |                           | 0.7                         | 994                       | 69.9                 | 5.3                    | 194                   | 0.0                   |  |
| 120 | 12/14/2008 |                           | -0.4                        | 999                       | 78.2                 | 0.4                    | 173                   | 0.0                   |  |



**Annex 5**
**Ambient conditions at the field test sites**

| No. | Date       | Test site | Ambient temperature<br>[°C] | Ambient pressure<br>[hPa] | Rel. humidity<br>[%] | Wind velocity<br>[m/s] | Wind direction<br>[°] | Precipitation<br>[mm] |
|-----|------------|-----------|-----------------------------|---------------------------|----------------------|------------------------|-----------------------|-----------------------|
| 121 | 12/15/2008 | Cologne   | 1.6                         | 1009                      | 80.1                 | 0.1                    | 164                   | 0.0                   |
| 122 | 12/16/2008 | (Winter)  | -0.8                        | 1006                      | 81.8                 | 0.3                    | 93                    | 0.0                   |
| 123 | 12/17/2008 |           | 0.9                         | 1009                      | 84.6                 | 0.4                    | 117                   | 4.2                   |
| 124 | 12/18/2008 |           | 4.5                         | 1012                      | 81.3                 | 2.1                    | 108                   | 3.9                   |
| 125 | 12/19/2008 |           | 5.8                         | 1016                      | 74.9                 | 3.1                    | 106                   | 8.3                   |
| 126 | 12/20/2008 |           | 7.8                         | 1018                      | 81.5                 | 2.2                    | 139                   | 17.1                  |
| 127 | 12/21/2008 |           | 9.1                         | 1023                      | 77.9                 | 4.2                    | 136                   | 1.5                   |
| 128 | 12/22/2008 |           | 7.1                         | 1026                      | 80.4                 | 1.6                    | 144                   | 0.3                   |
| 129 | 12/23/2008 |           | 4.9                         | 1028                      | 82.8                 | 0.1                    | 163                   | 0.0                   |
| 130 | 12/24/2008 |           | 5.4                         | 1023                      | 79.4                 | 1.2                    | 176                   | 0.0                   |
| 131 | 12/25/2008 |           | 1.6                         | 1028                      | 68.0                 | 0.6                    | 271                   | 0.0                   |
| 132 | 12/26/2008 |           | -1.3                        | 1030                      | 62.5                 | 0.7                    | 266                   | 0.0                   |
| 133 | 12/27/2008 |           | -3.4                        | 1027                      | 69.9                 | 0.7                    | 268                   | 0.0                   |
| 134 | 12/28/2008 |           | -4.7                        | 1023                      | 71.8                 | 0.6                    | 253                   | 0.0                   |
| 135 | 12/29/2008 |           | -2.7                        | 1024                      | 67.3                 | 0.4                    | 258                   | 0.0                   |
| 136 | 12/30/2008 |           | -3.3                        | 1022                      | 68.6                 | 0.6                    | 301                   | 0.0                   |
| 137 | 12/31/2008 |           | -3.1                        | 1020                      | 75.1                 | 0.8                    | 126                   | 0.0                   |
| 138 | 1/1/2009   |           | -2.9                        | 1021                      | 77.5                 | 0.1                    | 159                   | 0.0                   |
| 139 | 1/2/2009   |           | No data                     | 1022                      | No data              | No data                | No data               | 0.0                   |
| 140 | 1/3/2009   |           | -0.4                        | 1017                      | 68.8                 | 1.5                    | 188                   | 0.0                   |
| 141 | 1/4/2009   |           | -0.6                        | 1010                      | 75.6                 | 2.4                    | 161                   | 0.0                   |
| 142 | 1/5/2009   |           | -4.0                        | 1015                      | 70.6                 | 0.0                    | 253                   | 1.2                   |
| 143 | 1/6/2009   |           | -14.0                       | 1016                      | 76.0                 | 0.4                    | 187                   | 0.0                   |
| 144 | 1/7/2009   |           | -6.8                        | 1019                      | 76.6                 | 0.3                    | 161                   | 0.0                   |
| 145 | 1/8/2009   |           | -8.5                        | 1023                      | 78.6                 | 0.1                    | 249                   | 0.0                   |
| 146 | 1/9/2009   |           | -7.7                        | 1022                      | 71.6                 | 0.3                    | 209                   | 0.3                   |
| 147 | 1/10/2009  |           | -5.1                        | 1022                      | 65.5                 | 1.0                    | 198                   | 0.0                   |
| 148 | 1/11/2009  |           | -2.4                        | 1021                      | 61.9                 | 2.1                    | 234                   | 0.0                   |
| 149 | 1/12/2009  |           | 2.3                         | 1011                      | 58.8                 | 4.7                    | 182                   | 0.3                   |
| 150 | 1/13/2009  |           | 2.4                         | 1006                      | 67.3                 | 2.4                    | 74                    | 3.0                   |

Report on the suitability test of the ambient air quality measurement system  
BAM-1020 with PM2.5 pre-separator of the company Met One Instruments,  
Inc. for the component suspended particulate matter PM2.5,  
Report-No.: 936/21209919/A

**Annex 5**

**Ambient conditions at the field test sites**

| No. | Date      | Test site | Ambient temperature<br>[°C] | Ambient pressure<br>[hPa] | Rel. humidity<br>[%] | Wind velocity<br>[m/s] | Wind direction<br>[°] | Precipitation<br>[mm] |
|-----|-----------|-----------|-----------------------------|---------------------------|----------------------|------------------------|-----------------------|-----------------------|
| 151 | 1/14/2009 | Cologne   | 2.1                         | 1011                      | 81.4                 | 0.0                    | 147                   | 0.3                   |
| 152 | 1/15/2009 | (Winter)  | 1.4                         | 1014                      | 69.4                 | 3.0                    | 209                   | 0.0                   |
| 153 | 1/16/2009 |           | 2.1                         | 1013                      | 73.2                 | 4.0                    | 171                   | 0.0                   |
| 154 | 1/17/2009 |           | 5.4                         | 1004                      | 72.4                 | 4.2                    | 117                   | 0.9                   |
| 155 | 1/18/2009 |           | 3.8                         | 993                       | 73.5                 | 3.7                    | 106                   | 3.5                   |
| 156 | 1/19/2009 |           | 5.7                         | 983                       | 72.2                 | 5.1                    | 76                    | 5.6                   |
| 157 | 1/20/2009 |           | 0.3                         | 994                       | 76.8                 | 0.6                    | 160                   | 0.3                   |
| 158 | 1/21/2009 |           | 2.0                         | 1000                      | 72.8                 | 2.3                    | 128                   | 0.0                   |
| 159 | 1/22/2009 |           | 4.1                         | 983                       | 72.4                 | 6.9                    | 123                   | 14.5                  |
| 160 | 1/23/2009 |           | 3.8                         | 971                       | 76.1                 | 4.9                    | 115                   | 12.1                  |
| 161 | 1/24/2009 |           | 1.9                         | 988                       | 77.2                 | 0.8                    | 158                   | 0.0                   |
| 162 | 1/25/2009 |           | 1.4                         | 991                       | 72.3                 | 2.4                    | 267                   | 0.0                   |
| 163 | 1/26/2009 |           | 0.3                         | 999                       | 71.8                 | 0.9                    | 192                   | 0.0                   |
| 164 | 1/27/2009 |           | 1.3                         | 1009                      | 65.9                 | 0.4                    | 225                   | 0.0                   |
| 165 | 1/28/2009 |           | 0.1                         | 1013                      | 69.6                 | 0.6                    | 226                   | 0.0                   |
| 166 | 1/29/2009 |           | -0.2                        | 1015                      | 67.0                 | 1.8                    | 255                   | 0.0                   |
| 167 | 1/30/2009 |           | -0.6                        | 1014                      | 67.2                 | 2.8                    | 237                   | 0.0                   |
| 168 | 1/31/2009 |           | 0.7                         | 1009                      | 56.2                 | 3.3                    | 284                   | 0.0                   |
| 169 | 2/1/2009  |           | -0.3                        | 999                       | 59.4                 | 3.6                    | 289                   | 0.0                   |
| 170 | 2/2/2009  |           | 3.0                         | 992                       | 62.3                 | 2.2                    | 270                   | 0.0                   |
| 171 | 2/3/2009  |           | 0.9                         | 992                       | 78.8                 | 0.0                    | 74                    | 0.6                   |
| 172 | 2/4/2009  |           | 3.1                         | 989                       | 76.5                 | 0.8                    | 138                   | 0.0                   |
| 173 | 2/5/2009  |           | No data                     | 987                       | No data              | No data                | No data               | 0.0                   |
| 174 | 2/6/2009  |           | 2.0                         | 983                       | 83.1                 | 0.0                    | 250                   | 0.3                   |
| 175 | 2/7/2009  |           | 2.1                         | 988                       | 78.4                 | 2.4                    | 156                   | 0.6                   |
| 176 | 2/8/2009  |           | 1.8                         | 998                       | 72.0                 | 2.0                    | 131                   | 0.0                   |
| 177 | 2/9/2009  |           | 4.2                         | 987                       | 74.6                 | 5.4                    | 131                   | 15.3                  |
| 178 | 2/10/2009 |           | 2.7                         | 994                       | 76.1                 | 6.5                    | 138                   | 16.8                  |
| 179 | 2/11/2009 |           | 0.9                         | 1007                      | 75.1                 | 1.4                    | 139                   | 2.7                   |
| 180 | 2/12/2009 |           | 0.8                         | 1012                      | 77.0                 | 0.4                    | 175                   | 0.0                   |

**Annex 5**
**Ambient conditions at the field test sites**

| No. | Date      | Test site | Ambient temperature<br>[°C] | Ambient pressure<br>[hPa] | Rel. humidity<br>[%] | Wind velocity<br>[m/s] | Wind direction<br>[°] | Precipitation<br>[mm] |
|-----|-----------|-----------|-----------------------------|---------------------------|----------------------|------------------------|-----------------------|-----------------------|
| 181 | 2/13/2009 | Cologne   | 0.2                         | 1013                      | 75.7                 | 0.6                    | 208                   | 4.1                   |
| 182 | 2/14/2009 | (Winter)  | -1.6                        | 1021                      | 71.9                 | 0.8                    | 206                   | 0.0                   |
| 183 | 2/15/2009 |           | 0.6                         | 1017                      | 78.2                 | 0.9                    | 136                   | 10.6                  |
| 184 | 2/16/2009 |           | 5.7                         | 1011                      | 83.4                 | 3.8                    | 150                   | 21.5                  |
| 185 | 2/17/2009 |           | 0.5                         | 1017                      | 71.6                 | 1.8                    | 269                   | 0.6                   |
| 186 | 2/18/2009 |           | -0.7                        | 1019                      | 62.6                 | 0.8                    | 233                   | 0.0                   |
| 187 | 2/19/2009 |           | 3.1                         | 1019                      | 68.8                 | 1.2                    | 180                   | 3.9                   |
| 188 | 2/20/2009 |           | 4.5                         | 1022                      | 80.9                 | 2.2                    | 157                   | 2.4                   |
| 189 | 2/21/2009 |           | 5.3                         | 1020                      | 74.2                 | 1.2                    | 124                   | 4.4                   |
| 190 | 2/22/2009 |           | 5.8                         | 1013                      | 78.3                 | 4.5                    | 153                   | 3.9                   |
| 191 | 2/23/2009 |           | 5.1                         | 1013                      | 71.9                 | 3.1                    | 174                   | 0.6                   |
| 192 | 2/24/2009 |           | 2.2                         | 1021                      | 75.5                 | 0.9                    | 168                   | 0.0                   |
| 193 | 2/25/2009 |           | 6.3                         | 1018                      | 71.2                 | 2.9                    | 125                   | 0.6                   |
| 194 | 2/26/2009 |           | 7.1                         | 1011                      | 69.8                 | 5.0                    | 142                   | 0.6                   |
| 195 | 2/27/2009 |           | 7.8                         | 1011                      | 79.3                 | 2.2                    | 121                   | 0.9                   |
| 196 | 2/28/2009 |           | 7.6                         | 1005                      | 76.6                 | 0.7                    | 204                   | 0.0                   |
| 197 | 3/1/2009  |           | 9.5                         | 1002                      | 74.3                 | 2.1                    | 119                   | 3.0                   |
| 198 | 3/2/2009  |           | 5.1                         | 1009                      | 70.6                 | 1.4                    | 135                   | 0.0                   |
| 199 | 3/3/2009  |           | 6.8                         | 996                       | 58.0                 | 5.0                    | 126                   | 0.0                   |
| 200 | 3/4/2009  |           | 6.9                         | 980                       | 67.7                 | 3.0                    | 96                    | 6.2                   |
| 201 | 3/5/2009  |           | 4.2                         | 985                       | 81.2                 | 4.0                    | 176                   | 26.9                  |
| 202 | 3/6/2009  |           | 3.7                         | 998                       | 77.6                 | 4.6                    | 154                   | 6.5                   |
| 203 | 3/7/2009  |           | 8.0                         | 1003                      | 69.7                 | 1.3                    | 89                    | 0.6                   |
| 204 | 3/8/2009  |           | 6.2                         | 998                       | 68.3                 | 3.7                    | 121                   | 5.0                   |
| 205 | 3/9/2009  |           | 5.9                         | 1004                      | 67.8                 | 4.3                    | 119                   | 3.3                   |
| 206 | 3/10/2009 |           | 5.4                         | 1004                      | 75.7                 | 4.5                    | 124                   | 7.7                   |
| 207 | 3/11/2009 |           | 5.4                         | 1016                      | 69.7                 | 1.7                    | 96                    | 2.4                   |
| 208 | 3/12/2009 |           | 7.7                         | 1012                      | 81.9                 | 2.1                    | 158                   | 11.0                  |
| 209 | 3/13/2009 |           | 8.1                         | 1012                      | 67.9                 | 1.1                    | 155                   | 0.0                   |
| 210 | 3/14/2009 |           | 9.9                         | 1012                      | 70.3                 | 3.9                    | 177                   | 1.5                   |

Report on the suitability test of the ambient air quality measurement system BAM-1020 with PM2.5 pre-separator of the company Met One Instruments, Inc. for the component suspended particulate matter PM2.5, Report-No.: 936/21209919/A

**Annex 5**

**Ambient conditions at the field test sites**

| No. | Date      | Test site | Ambient temperature<br>[°C] | Ambient pressure<br>[hPa] | Rel. humidity<br>[%] | Wind velocity<br>[m/s] | Wind direction<br>[°] | Precipitation<br>[mm] |
|-----|-----------|-----------|-----------------------------|---------------------------|----------------------|------------------------|-----------------------|-----------------------|
| 211 | 3/15/2009 | Cologne   | 8.0                         | 1022.9                    | 72.8                 | 2.8                    | 153.4                 | 0.0                   |
| 212 | 3/16/2009 | (Winter)  | 7.0                         | 1025.4                    | 72.6                 | 0.1                    | 147.8                 | 0.0                   |
| 213 | 3/17/2009 |           | 6.1                         | 1027.5                    | 66.7                 | 0.4                    | 204.0                 | 0.0                   |
| 214 | 3/18/2009 |           | 4.6                         | 1021.1                    | 59.6                 | 0.1                    | 218.6                 | 0.0                   |
| 215 | 3/19/2009 |           | 5.4                         | 1022.0                    | 57.3                 | 0.6                    | 199.4                 | 0.0                   |
| 216 | 3/20/2009 |           | 4.6                         | 1023.1                    | 50.9                 | 0.8                    | 234.3                 | 0.0                   |
| 217 | 3/21/2009 |           | 5.6                         | 1019.3                    | 58.1                 | 1.2                    | 139.8                 | 0.0                   |
| 218 | 3/22/2009 |           | 8.5                         | 1015.0                    | 63.4                 | 5.3                    | 164.1                 | 0.0                   |
| 219 | 3/23/2009 |           | 5.3                         | 998.8                     | 71.5                 | 6.5                    | 144.3                 | 9.2                   |
| 220 | 3/24/2009 |           | 3.5                         | 1001.0                    | 67.4                 | 3.2                    | 114.1                 | 9.2                   |
| 221 | 3/25/2009 |           | 5.4                         | 994.9                     | 75.6                 | 3.8                    | 131.6                 | 8.6                   |
| 222 | 3/26/2009 |           | 7.3                         | 993.8                     | 74.3                 | 3.6                    | 95.2                  | 14.5                  |
| 223 | 3/27/2009 |           | 6.9                         | 990.3                     | 66.5                 | 3.9                    | 91.8                  | 1.8                   |
| 224 | 3/28/2009 |           | 6.5                         | 994.7                     | 70.8                 | 3.3                    | 122.3                 | 3.9                   |
| 225 | 3/29/2009 |           | 4.8                         | 1007.7                    | 70.0                 | 0.9                    | 185.6                 | 0.3                   |
| 226 | 3/30/2009 |           | 5.2                         | 1015.9                    | 65.9                 | 0.7                    | 161.6                 | 0.0                   |
| 227 | 3/31/2009 |           | 10.3                        | 1013.7                    | 50.7                 | 0.9                    | 210.0                 | 0.0                   |
| 228 | 4/1/2009  |           | 12.9                        | 1011.2                    | 48.2                 | 1.5                    | 247.4                 | 0.0                   |
| 229 | 4/2/2009  |           | 14.9                        | 1008.3                    | 55.0                 | 1.2                    | 203.4                 | 0.0                   |
| 230 | 4/3/2009  |           | 17.0                        | 1008.8                    | 58.6                 | 1.5                    | 116.0                 | 0.0                   |
| 231 | 4/4/2009  |           | 13.6                        | 1014.1                    | 64.4                 | 0.9                    | 170.3                 | 0.0                   |
| 232 | 4/5/2009  |           | 11.6                        | 1012.5                    | 68.2                 | 0.6                    | 207.5                 | 0.0                   |
| 233 | 4/6/2009  |           | 16.0                        | 1002.3                    | 54.5                 | 1.5                    | 226.7                 | 0.0                   |
| 234 | 4/7/2009  |           | 12.7                        | 1004.8                    | 70.5                 | 1.9                    | 94.5                  | 6.5                   |
| 235 | 4/8/2009  |           | 13.0                        | 1007.1                    | 66.5                 | 2.5                    | 136.7                 | 0.9                   |
| 236 | 4/9/2009  |           | 15.5                        | 1005.1                    | 62.0                 | 1.5                    | 189.4                 | 0.0                   |
| 237 | 4/10/2009 |           | 17.7                        | 999.7                     | 53.3                 | 1.4                    | 203.8                 | 0.0                   |
| 238 | 4/11/2009 |           | 17.8                        | 1001.1                    | 56.5                 | 0.5                    | 148.4                 | 0.0                   |
| 239 | 4/12/2009 |           | 15.1                        | 1002.6                    | 73.3                 | 0.9                    | 166.7                 | 0.0                   |
| 240 | 4/13/2009 |           | 12.4                        | 1002.0                    | 76.5                 | 0.1                    | 184.0                 | 0.0                   |

**Annex 5**
**Ambient conditions at the field test sites**

| No. | Date      | Test site            | Ambient temperature<br>[°C] | Ambient pressure<br>[hPa] | Rel. humidity<br>[%] | Wind velocity<br>[m/s] | Wind direction<br>[°] | Precipitation<br>[mm] |
|-----|-----------|----------------------|-----------------------------|---------------------------|----------------------|------------------------|-----------------------|-----------------------|
| 241 | 8/9/2009  | Bornheim<br>(Summer) | 20.0                        | 1008.6                    | 72.3                 | 0.0                    | defective             | 0.0                   |
| 242 | 8/10/2009 |                      | 19.8                        | 1007.4                    | 66.0                 | 0.2                    | defective             | 0.3                   |
| 243 | 8/11/2009 |                      | 19.0                        | 1010.6                    | 70.5                 | 0.5                    | defective             | 0.6                   |
| 244 | 8/12/2009 |                      | 18.7                        | 1009.0                    | 73.5                 | 0.0                    | defective             | 20.0                  |
| 245 | 8/13/2009 |                      | 17.1                        | 1008.7                    | 77.3                 | 0.1                    | defective             | 1.8                   |
| 246 | 8/14/2009 |                      | 17.3                        | 1010.0                    | 70.2                 | 0.0                    | defective             | 0.0                   |
| 247 | 8/15/2009 |                      | 22.3                        | 1007.1                    | 56.2                 | 0.0                    | defective             | 0.0                   |
| 248 | 8/16/2009 |                      | 22.1                        | 1006.5                    | 64.5                 | 0.0                    | defective             | 0.0                   |
| 249 | 8/17/2009 |                      | 20.1                        | 1007.5                    | 64.9                 | 0.4                    | defective             | 0.0                   |
| 250 | 8/18/2009 |                      | 20.4                        | 1012.2                    | 57.7                 | 0.0                    | defective             | 0.0                   |
| 251 | 8/19/2009 |                      | 24.5                        | 1010.2                    | 53.9                 | 0.2                    | defective             | 0.0                   |
| 252 | 8/20/2009 |                      | 25.3                        | 1008.2                    | 61.5                 | 0.5                    | defective             | 17.1                  |
| 253 | 8/21/2009 |                      | 17.2                        | 1013.3                    | 65.4                 | 0.0                    | defective             | 0.3                   |
| 254 | 8/22/2009 |                      | 17.4                        | 1015.6                    | 60.6                 | 0.0                    | defective             | 0.0                   |
| 255 | 8/23/2009 |                      | 19.3                        | 1009.3                    | 55.6                 | 0.4                    | defective             | 0.0                   |
| 256 | 8/24/2009 |                      | 23.0                        | 1000.2                    | 55.5                 | 0.8                    | defective             | 1.5                   |
| 257 | 8/25/2009 |                      | 19.4                        | 1004.1                    | 74.1                 | 0.1                    | defective             | 5.0                   |
| 258 | 8/26/2009 |                      | 16.1                        | 1006.9                    | 74.6                 | 0.0                    | defective             | 0.0                   |
| 259 | 8/27/2009 |                      | 23.4                        | 1005.8                    | 56.4                 | 0.0                    | defective             | 0.0                   |
| 260 | 8/28/2009 |                      | 17.7                        | 1006.0                    | 57.9                 | 0.6                    | defective             | 0.0                   |
| 261 | 8/29/2009 |                      | 14.9                        | 1012.1                    | 57.6                 | 1.1                    | defective             | 0.0                   |
| 262 | 8/30/2009 |                      | 15.7                        | 1012.1                    | 59.6                 | 0.3                    | defective             | 0.0                   |
| 263 | 8/31/2009 |                      | 23.5                        | 1005.5                    | 44.4                 | 0.8                    | defective             | 0.0                   |
| 264 | 9/1/2009  |                      | 14.0                        | 1004.3                    | 80.3                 | 0.0                    | defective             | 12.4                  |
| 265 | 9/2/2009  |                      | 17.5                        | 1001.8                    | 65.9                 | 0.0                    | defective             | 2.4                   |
| 266 | 9/3/2009  |                      | 15.8                        | 995.9                     | 63.8                 | 1.3                    | defective             | 2.4                   |
| 267 | 9/4/2009  |                      | 14.1                        | 1001.3                    | 67.6                 | 1.0                    | defective             | 3.9                   |
| 268 | 9/5/2009  | 13.1                 | 1013.4                      | 70.0                      | 0.6                  | defective              | 4.4                   |                       |
| 269 | 9/6/2009  | 14.7                 | 1015.2                      | 68.4                      | 0.0                  | defective              | 0.0                   |                       |
| 270 | 9/7/2009  | 18.1                 | 1013.4                      | 64.0                      | 0.0                  | defective              | 0.0                   |                       |

Report on the suitability test of the ambient air quality measurement system  
BAM-1020 with PM2.5 pre-separator of the company Met One Instruments,  
Inc. for the component suspended particulate matter PM2.5,  
Report-No.: 936/21209919/A

**Annex 5**

**Ambient conditions at the field test sites**

| No. | Date      | Test site            | Ambient temperature<br>[°C] | Ambient pressure<br>[hPa] | Rel. humidity<br>[%] | Wind velocity<br>[m/s] | Wind direction<br>[°] | Precipitation<br>[mm] |
|-----|-----------|----------------------|-----------------------------|---------------------------|----------------------|------------------------|-----------------------|-----------------------|
| 271 | 9/8/2009  | Bornheim<br>(Summer) | 20.6                        | 1013.2                    | 57.8                 | 0.0                    | defective             | 0.0                   |
| 272 | 9/9/2009  |                      | 20.6                        | 1016.5                    | 63.6                 | 0.5                    | defective             | 0.0                   |
| 273 | 9/10/2009 |                      | 15.7                        | 1022.1                    | 68.9                 | 0.3                    | defective             | 0.0                   |
| 274 | 9/11/2009 |                      | 15.7                        | 1021.5                    | 63.1                 | 0.2                    | defective             | 0.0                   |
| 275 | 9/12/2009 |                      | 15.9                        | 1016.8                    | 64.1                 | 0.1                    | defective             | 0.0                   |
| 276 | 9/13/2009 |                      | 12.9                        | 1011.7                    | 77.1                 | 0.8                    | defective             | 1.2                   |
| 277 | 9/14/2009 |                      | 13.2                        | 1009.2                    | 76.8                 | 0.7                    | defective             | 6.8                   |
| 278 | 9/15/2009 |                      | 15.4                        | 1008.4                    | 76.4                 | 0.0                    | defective             | 0.0                   |
| 279 | 9/16/2009 |                      | 17.2                        | 1007.2                    | 71.9                 | 0.2                    | defective             | 0.0                   |
| 280 | 9/17/2009 |                      | 14.6                        | 1010.2                    | 70.1                 | 0.0                    | defective             | 0.0                   |
| 281 | 9/18/2009 |                      | 18.0                        | 1008.2                    | 68.1                 | 0.0                    | defective             | 0.0                   |
| 282 | 9/19/2009 |                      | 19.7                        | 1007.3                    | 70.0                 | 0.0                    | defective             | 0.0                   |
| 283 | 9/20/2009 |                      | 18.7                        | 1012.3                    | 72.3                 | 0.0                    | defective             | 0.0                   |
| 284 | 9/21/2009 |                      | 14.9                        | 1016.8                    | 71.4                 | 0.0                    | defective             | 0.0                   |
| 285 | 9/22/2009 |                      | 16.9                        | 1016.5                    | 64.3                 | 0.0                    | defective             | 0.0                   |
| 286 | 9/23/2009 |                      | 17.4                        | 1016.4                    | 70.9                 | 0.0                    | defective             | 0.0                   |
| 287 | 9/24/2009 |                      | 13.8                        | 1015.9                    | 79.1                 | 0.0                    | defective             | 0.6                   |
| 288 | 9/25/2009 |                      | 13.2                        | 1017.9                    | 69.2                 | 0.0                    | defective             | 0.0                   |
| 289 | 9/26/2009 |                      | 13.7                        | 1017.5                    | 65.9                 | 0.0                    | defective             | 0.0                   |
| 290 | 9/27/2009 |                      | 14.2                        | 1017.1                    | 66.9                 | 0.0                    | defective             | 0.0                   |
| 291 | 9/28/2009 |                      | 14.7                        | 1014.5                    | 69.6                 | 0.0                    | defective             | 0.0                   |
| 292 | 9/29/2009 |                      | 15.7                        | 1011.3                    | 72.6                 | 0.0                    | defective             | 0.3                   |
| 293 | 9/30/2009 |                      | 15.5                        | 1007.7                    | 77.0                 | 0.0                    | defective             | 1.2                   |
| 294 | 10/1/2009 |                      | 12.0                        | 1007.4                    | 74.9                 | 0.1                    | defective             | 2.1                   |
| 295 | 10/2/2009 |                      | 10.9                        | 1008.6                    | 66.9                 | 0.0                    | defective             | 0.0                   |
| 296 | 10/3/2009 |                      | 13.4                        | 1002.1                    | 63.9                 | 0.5                    | defective             | 0.0                   |
| 297 | 10/4/2009 |                      | 11.8                        | 1005.3                    | 75.4                 | 0.4                    | defective             | 3.3                   |
| 298 | 10/5/2009 |                      | 13.1                        | 1003.9                    | 80.0                 | 0.8                    | defective             | 6.5                   |
| 299 | 10/6/2009 |                      | 15.9                        | 1003.5                    | 82.3                 | 0.0                    | defective             | 10.3                  |
| 300 | 10/7/2009 |                      | 19.2                        | 1000.6                    | 75.9                 | 0.1                    | defective             | 8.6                   |

**Annex 5**
**Ambient conditions at the field test sites**

| No. | Date       | Test site              | Ambient temperature<br>[°C] | Ambient pressure<br>[hPa] | Rel. humidity<br>[%] | Wind velocity<br>[m/s] | Wind direction<br>[°] | Precipitation<br>[mm] |
|-----|------------|------------------------|-----------------------------|---------------------------|----------------------|------------------------|-----------------------|-----------------------|
| 301 | 10/8/2009  | Bornheim<br>(Summer)   | 10.7                        | 1010                      | 78.6                 | 0.4                    | defective             | 0.0                   |
| 302 | 10/9/2009  |                        | 12.1                        | 1009                      | 69.1                 | 0.2                    | defective             | 12.4                  |
| 303 | 10/10/2009 |                        | 13.2                        | 1005                      | 80.0                 | 0.2                    | defective             | 4.2                   |
| 304 | 10/11/2009 |                        | 11.9                        | 1003                      | 76.1                 | 0.8                    | defective             | 5.9                   |
| 305 | 10/12/2009 |                        | 9.8                         | 1014                      | 70.9                 | 1.9                    | defective             | 2.1                   |
| 306 | 10/13/2009 |                        | 7.4                         | 1019                      | 68.5                 | 0.7                    | defective             | 0.0                   |
| 307 | 10/14/2009 |                        | 3.3                         | 1022                      | 67.4                 | 0.1                    | defective             | 0.0                   |
| 308 | 10/15/2009 |                        | 5.4                         | 1019                      | 66.9                 | 0.3                    | defective             | 0.3                   |
| 309 | 10/16/2009 |                        | 8.8                         | 1013                      | 70.8                 | 4.4                    | defective             | 1.5                   |
| 310 | 10/17/2009 |                        | 7.2                         | 1014                      | 69.7                 | 1.1                    | defective             | 0.0                   |
| 311 | 10/18/2009 |                        | 5.5                         | 1014                      | 73.1                 | 0.0                    | defective             | 0.0                   |
| 312 | 10/19/2009 |                        | 5.6                         | 1008                      | 66.3                 | 0.2                    | defective             | 0.0                   |
| 313 | 10/20/2009 |                        | 7.8                         | 999                       | 61.4                 | 4.2                    | defective             | 0.0                   |
| 314 | 10/21/2009 |                        | 10.0                        | 995                       | 57.1                 | 1.5                    | defective             | 1.2                   |
| 315 | 10/22/2009 |                        | 8.7                         | 996                       | 73.5                 | 0.0                    | defective             | 0.0                   |
| 316 | 12/9/2009  | Teddington<br>(Winter) | 9.8                         | 1017                      | 94.1                 | 0.1                    | 221                   | 0.3                   |
| 317 | 12/10/2009 |                        | 3.9                         | 1028                      | 90.9                 | 0.2                    | 244                   | 0.3                   |
| 318 | 12/11/2009 |                        | 5.7                         | 1029                      | 93.8                 | 0.4                    | 231                   | 0.0                   |
| 319 | 12/12/2009 |                        | 5.8                         | 1026                      | 83.9                 | 0.8                    | 200                   | 0.0                   |
| 320 | 12/13/2009 |                        | 4.2                         | 1022                      | 87.7                 | 0.5                    | 234                   | 0.3                   |
| 321 | 12/14/2009 |                        | 3.4                         | 1017                      | 88.8                 | 0.2                    | 201                   | 0.0                   |
| 322 | 12/15/2009 |                        | -0.6                        | 1015                      | 87.5                 | 0.2                    | 196                   | 0.3                   |
| 323 | 12/16/2009 |                        | 1.5                         | 1006                      | 96.9                 | 0.2                    | 245                   | 2.8                   |
| 324 | 12/17/2009 |                        | 1.3                         | 1008                      | 85.2                 | 2.4                    | 225                   | 1.3                   |
| 325 | 12/18/2009 |                        | -0.8                        | 1013                      | 86.6                 | 0.9                    | 281                   | 0.0                   |
| 326 | 12/19/2009 |                        | -0.1                        | 1002                      | 85.9                 | 0.2                    | 240                   | 1.8                   |
| 327 | 12/20/2009 |                        | -0.9                        | 995                       | 87.3                 | 0.1                    | 206                   | 0.0                   |
| 328 | 12/21/2009 |                        | 1.1                         | 984                       | 97.3                 | 0.3                    | 187                   | 8.6                   |
| 329 | 12/22/2009 |                        | -2.1                        | 988                       | 98.3                 | 0.0                    | 218                   | 0.3                   |
| 330 | 12/23/2009 |                        | 2.8                         | 987                       | 95.9                 | 0.4                    | 173                   | 7.1                   |

Report on the suitability test of the ambient air quality measurement system  
 BAM-1020 with PM2.5 pre-separator of the company Met One Instruments,  
 Inc. for the component suspended particulate matter PM2.5,  
 Report-No.: 936/21209919/A

**Annex 5**

**Ambient conditions at the field test sites**

| No. | Date       | Test site              | Ambient temperature<br>[°C] | Ambient pressure<br>[hPa] | Rel. humidity<br>[%] | Wind velocity<br>[m/s] | Wind direction<br>[°] | Precipitation<br>[mm] |
|-----|------------|------------------------|-----------------------------|---------------------------|----------------------|------------------------|-----------------------|-----------------------|
| 331 | 12/24/2009 | Teddington<br>(Winter) | 4.1                         | 985.9                     | 94.1                 | 0.3                    | 217.3                 | 0.5                   |
| 332 | 12/25/2009 |                        | 4.1                         | 998                       | 94.5                 | 0.2                    | 210                   | 2.3                   |
| 333 | 12/26/2009 |                        | 5.9                         | 995                       | 90.2                 | 0.3                    | 200                   | 0.8                   |
| 334 | 12/27/2009 |                        | 2.4                         | 1000                      | 86.2                 | 0.3                    | 240                   | 0.0                   |
| 335 | 12/28/2009 |                        | 3.7                         | 998                       | 88.6                 | 1.2                    | 80                    | 1.8                   |
| 336 | 12/29/2009 |                        | 4.8                         | 988                       | 95.9                 | 1.7                    | 94                    | 11.7                  |
| 337 | 12/30/2009 |                        | 4.3                         | 992                       | 93.1                 | 1.9                    | 101                   | 5.6                   |
| 338 | 12/31/2009 |                        | 2.3                         | 998                       | 81.8                 | 1.1                    | 207                   | 0.0                   |
| 339 | 1/1/2010   |                        | -0.1                        | 1008                      | 88.3                 | 0.2                    | 243                   | 0.0                   |
| 340 | 1/2/2010   |                        | 1.6                         | 1016                      | 87.2                 | 0.1                    | 245                   | 0.0                   |
| 341 | 1/3/2010   |                        | -1.6                        | 1021                      | 88.3                 | 0.3                    | 205                   | 0.0                   |
| 342 | 1/4/2010   |                        | -3.7                        | 1012                      | 97.2                 | 0.0                    | 232                   | 0.0                   |
| 343 | 1/5/2010   |                        | 0.8                         | 998                       | 89.9                 | 0.7                    | 129                   | 4.8                   |
| 344 | 1/6/2010   |                        | -2.3                        | 1005                      | 94.3                 | 0.7                    | 215                   | 1.8                   |
| 345 | 1/7/2010   |                        | -1.2                        | 1013                      | 91.1                 | 0.5                    | 240                   | 0.0                   |
| 346 | 1/8/2010   |                        | -1.6                        | 1022                      | 91.1                 | 0.8                    | 225                   | 0.3                   |
| 347 | 1/9/2010   |                        | 0.9                         | 1018                      | 79.3                 | 1.8                    | 161                   | 0.0                   |
| 348 | 1/10/2010  |                        | 1.4                         | 1015                      | 90.5                 | 0.7                    | 92                    | 1.3                   |
| 349 | 1/11/2010  |                        | 1.5                         | 1015                      | 86.0                 | 0.3                    | 137                   | 0.3                   |
| 350 | 1/12/2010  |                        | 1.4                         | 1000                      | 85.9                 | 1.5                    | 103                   | 0.0                   |
| 351 | 1/13/2010  |                        | 1.5                         | 998                       | 94.8                 | 0.1                    | 151                   | 8.6                   |
| 352 | 1/14/2010  |                        | 2.5                         | 1008                      | 97.0                 | 0.1                    | 229                   | 0.3                   |
| 353 | 1/15/2010  |                        | 5.6                         | 1011                      | 90.0                 | 1.8                    | 151                   | 1.8                   |
| 354 | 1/16/2010  |                        | 5.7                         | 1003                      | 96.3                 | 0.4                    | 202                   | 9.1                   |
| 355 | 1/17/2010  |                        | 4.1                         | 1019                      | 93.9                 | 0.1                    | 219                   | 0.0                   |
| 356 | 1/18/2010  |                        | 6.2                         | 1021                      | 97.8                 | 0.1                    | 199                   | 0.0                   |
| 357 | 1/19/2010  |                        | 6.4                         | 1012                      | 83.7                 | 1.4                    | 111                   | 1.0                   |
| 358 | 1/20/2010  |                        | 3.0                         | 1012                      | 92.1                 | 0.2                    | 227                   | 3.8                   |
| 359 | 1/21/2010  |                        | 6.1                         | 1015                      | 85.2                 | 1.1                    | 154                   | 0.3                   |
| 360 | 1/22/2010  |                        | 7.6                         | 1014                      | 95.0                 | 0.5                    | 209                   | 7.4                   |



**Annex 5**
**Ambient conditions at the field test sites**

| No. | Date      | Test site              | Ambient temperature<br>[°C] | Ambient pressure<br>[hPa] | Rel. humidity<br>[%] | Wind velocity<br>[m/s] | Wind direction<br>[°] | Precipitation<br>[mm] |
|-----|-----------|------------------------|-----------------------------|---------------------------|----------------------|------------------------|-----------------------|-----------------------|
| 361 | 1/23/2010 | Teddington<br>(Winter) | 4.8                         | 1018.4                    | 87.0                 | 0.2                    | 262.2                 | 0.0                   |
| 362 | 1/24/2010 |                        | 4.4                         | 1022                      | 91.1                 | 0.1                    | 241                   | 1.3                   |
| 363 | 1/25/2010 |                        | 3.2                         | 1033                      | 80.0                 | 0.9                    | 161                   | 0.5                   |
| 364 | 1/26/2010 |                        | 0.0                         | 1037                      | 83.2                 | 0.5                    | 167                   | 0.0                   |
| 365 | 1/27/2010 |                        | 4.4                         | 1018                      | 85.5                 | 0.3                    | 247                   | 1.0                   |
| 366 | 1/28/2010 |                        | 5.5                         | 1000                      | 86.4                 | 0.5                    | 247                   | 8.1                   |
| 367 | 1/29/2010 |                        | 1.3                         | 992                       | 76.9                 | 0.9                    | 279                   | 0.3                   |
| 368 | 1/30/2010 |                        | -0.9                        | 1001                      | 84.4                 | 0.2                    | 240                   | 0.0                   |
| 369 | 1/31/2010 |                        | 0.0                         | 1005                      | 91.2                 | 0.1                    | 241                   | 0.0                   |
| 370 | 2/1/2010  |                        | 3.1                         | 1010                      | 83.9                 | 0.4                    | 222                   | 0.3                   |
| 371 | 2/2/2010  |                        | 5.9                         | 1002                      | 89.6                 | 0.3                    | 229                   | 1.0                   |
| 372 | 2/3/2010  |                        | 6.7                         | 1004                      | 91.0                 | 0.2                    | 180                   | 2.0                   |
| 373 | 2/4/2010  |                        | 7.6                         | 997                       | 86.1                 | 1.3                    | 153                   | 2.3                   |

## Annex 6: Software version



### Remark

The test was performed with the software version 3236-07 5.01 (status July 2008).

The software has been constantly developed and optimized up to version 3236-07 5.0.10 during the test program. The changes up to version 3236-07 5.0.5 have been already presented in a statement and have been assessed positively by the responsible working group „Test reports“. The additional changes from version 3236-07 5.0.5 to version 3236-07 5.0.10 are described in Figure 64.

No influences on the system performance are expected from the changes which were made on the software up to version 3236-07 5.0.10.

30. März 2010

TÜV Rheinland Immissionsschutz und Energiesysteme GmbH  
Kärsten Pletscher

Am Grünen Stein  
D - 51105 Köln

Sehr geehrter Herr Pletscher,

Wir haben die im Folgenden aufgelisteten Änderungen in unserer Geräte-Software durchgeführt um unser Messgerät den Marktanforderungen anzupassen. Die aktuelle Software ändert sich damit von Firmware 5.0.5 zur neuen Versions-Nummer 5.0.10.



Met One  
Instruments

Met One Instruments, Inc.

1000 Spectrum Blvd.

South Hill, Colorado 80120

Phone (303) 471-1111

Met One (USA) LLC, Inc.

www.metone.com

Germany (11409)

TÜV Rheinland, Inc. (114)

Köln, Germany (114)

Phone (49) 221 91 88 97

fax (49) 221 91 88 98

1. Änderungen zu Version 5.0.6  
Ermöglicht die Ausgabe des Standard Datenfiles auch über den Reportprozessor.
2. Änderungen zu 5.0.7  
Diese Softwareversion behebt einen Fehler wo unter ungünstigen Umständen ein fehlerhafter Filterabdruckmechanismus nicht richtig erkannt wurde und dem unter Umständen nicht doppelte Messwerte ohne Fehlerkennung ausgegeben wurden.
3. Änderungen zu 5.0.8  
Behebung eines Softwarefehlers mit dem sensoron reset signal im „early cycle mode“ bei dem die Uhr des Gerätes nicht immer richtig synchronisiert wurde.
4. Änderungen zu 5.0.9  
Softwareaktualisierung des BX-596-1 Sensors in die Firmware integriert (Automatisches erkennen des neuen Sensors und Einstellen des Messbereiches über die AutoID Funktion). Der neue BX-596-1 hat einen deutlich erweiterten Temperatur- und Druckmessbereich (von -30C bis 50C und von 400mmHg bis 825 mmHg).
5. Änderungen zu 5.0.10  
Änderungen in der Ausgabe des BH-Protokolls. Zusätzlich wurde ein frei konfigurierbares Abgabeprotokoll für die serielle Schnittstelle integriert, die eine einfachere Kommunikation mit verschiedenen Datenspeichersystemen ermöglicht.

Wie sie aus der obigen Liste sehen können betreffen die meisten durchgeführten Änderungen lediglich Funktionserweiterungen und Fehlerbehebungen und Verbesserung des Bayer-Hassen Protokolls, sowie die Erweiterung der Datenabgabefunktionen.

Die Einführung des BX-596-1 war für Kunden in Alaska und für Kunden in höheren Bergregionen notwendig. Die Funktion des Sensors in der Software hat sich nicht geändert, lediglich die Skalierung.

Diese Änderungen haben keinen negativen Einfluss auf die geprüfte Funktion des Messgerätes.

Bitte vertrauen Sie die notwendigen Schritte, dass die Eignungsprüfungsbeurteilung die neue Software mit einschließt.

Mit freundlichen Grüßen

Dr. Herbert Schlösser  
VP Particulate Air Business Division

Figure 64: Software changes from version 5.0.5 to version 5.0.10

## Appendix 2

### Filter weighing methodology

#### A) German sites (Cologne and Bornheim)

##### A.1 Carrying out the weighing

All weightings are done in an air-conditioned weighing room. Ambient conditions are 20°C ±1°C and 50 % ±5 % rel. humidity, which conforms to the requirements of Standard EN 14907.

The filters used in the field test are weighed manually. The filters (including control filters) are placed on sieves for the purpose of conditioning to avoid overlap.

The specifications for pre- and post-weighing are specified beforehand and conform to the Standard.

| Before sampling = pre-weighing          | After sampling = post-weighing |
|---|--------------------------------|
| Conditioning 48 h + 2 h                 | Conditioning 48 h + 2 h        |
| Filter weighing                         | Filter weighing                |
| Re-conditioning 24 h + 2 h              | Re-conditioning 24 h + 2 h     |
| Filter weighing and immediate packaging | Filter weighing                |

The balance is always kept ready for use. An internal calibration process is started prior to each weighing series. The standard weight of 200 mg is weighed as reference and the boundary conditions are noted if nothing out of ordinary results from the calibration process. Deviations to prior measurements conform to the Standard and do not exceed 20 µg (refer to Figure 65).

All six control filters are weighed afterwards and a warning is displayed for control filters with deviations > 40 µg during evaluation. These control filters are not used for post-weighing. Instead, the first three acceptable control filters are used while the others remain in the protective jar in order to replace a defective or deviating filter, if necessary. Figure 66 shows an exemplary process over a period of more than 4 months.

All filters which deviate more than 40 µg between the first and second weighing are excluded during the pre-weighing process. Filters which deviate more than 60 µg are not considered for evaluation after post-weighing, as conforming to standards.

Weighed filters are packed in separate polystyrene jars for transport and storage. These jars remain closed until the filter is placed in the filter holder. Virgin filters can be stored in the weighing room for up to 28 days before sampling. Another pre-weighing is carried out if this period is exceeded.

Sampled filters can be stored for not more than 15 days at a temperature of 23 °C or less. The filters are stored at 7 °C in a refrigerator.

## A2 Filter evaluation

The filters are evaluated with the help of a corrective term in order to minimize relative mass changes caused by the weighing room conditions.

Equation:

$$\text{Dust} = \text{MF}_{\text{post}} - ( \text{M}_{\text{Tara}} \times ( \text{MKon}_{\text{post}} / \text{MKon}_{\text{pre}} ) ) \quad (\text{F1})$$

$\text{MKon}_{\text{pre}}$  = average mass of the 3 control filters after 48 h and 72 h pre-weighing

$\text{MKon}_{\text{post}}$  = average mass of the 3 control filters after 48 h and 72 h post-weighing

$\text{M}_{\text{Tara}}$  = average mass of the filter after 48 h and 72 h pre-weighing

$\text{MF}_{\text{post}}$  = average mass of the loaded filter after 48 h and 72 h post-weighing

Dust = corrected dust mass of the filter

This shows that the method becomes independent from weighing room conditions due to the corrective calculation. Influence due to the water content of the filter mass between virgin and loaded filter can be controlled and do not change the dust content of sampled filters. Hence, Point EN 14907 9.3.2.5 is fulfilled.

The exemplary course of the standard weight between November 2008 and February 2009 shows that the allowed deviation of not more than 20 µg on the previous measurement is not exceeded.

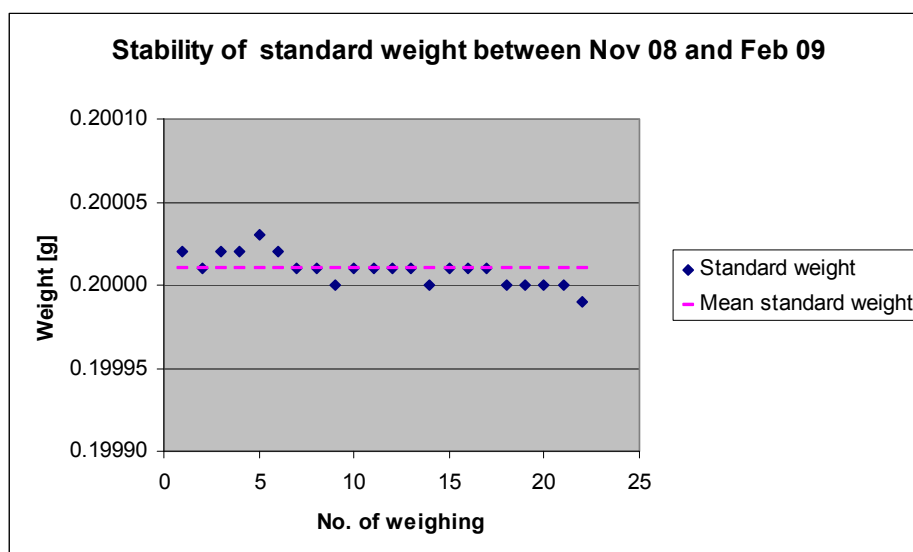

Figure 65.: Stability of standard weight

*Table 36: Stability standard weight*

| Date       | Weighing No. | Standard weight<br>g | Deviation from<br>prev. weighing<br>µg |
|------------|--------------|----------------------|--|
| 12.11.2008 | 1            | 0.20002              |  |
| 13.11.2008 | 2            | 0.20001              | -10                                    |
| 10.12.2008 | 3            | 0.20002              | 10                                     |
| 11.12.2008 | 4            | 0.20002              | 0                                      |
| 17.12.2008 | 5            | 0.20003              | 10                                     |
| 18.12.2008 | 6            | 0.20002              | -10                                    |
| 07.01.2009 | 7            | 0.20001              | -10                                    |
| 08.01.2009 | 8            | 0.20001              | 0                                      |
| 14.01.2009 | 9            | 0.20000              | -10                                    |
| 15.01.2009 | 10           | 0.20001              | 10                                     |
| 21.01.2009 | 11           | 0.20001              | 0                                      |
| 22.01.2009 | 12           | 0.20001              | 0                                      |
| 29.01.2009 | 13           | 0.20001              | 0                                      |
| 30.01.2009 | 14           | 0.20000              | -10                                    |
| 04.02.2008 | 15           | 0.20001              | 10                                     |
| 05.02.2009 | 16           | 0.20001              | 0                                      |
| 11.02.2009 | 17           | 0.20001              | 0                                      |
| 12.02.2009 | 18           | 0.20000              | -10                                    |
| 18.02.2009 | 19           | 0.20000              | 0                                      |
| 19.02.2009 | 20           | 0.20000              | 0                                      |
| 26.02.2009 | 21           | 0.20000              | 0                                      |
| 27.02.2009 | 22           | 0.19999              | -10                                    |

Highlighted yellow = average value

Highlighted green = lowest value

Highlighted blue = highest value

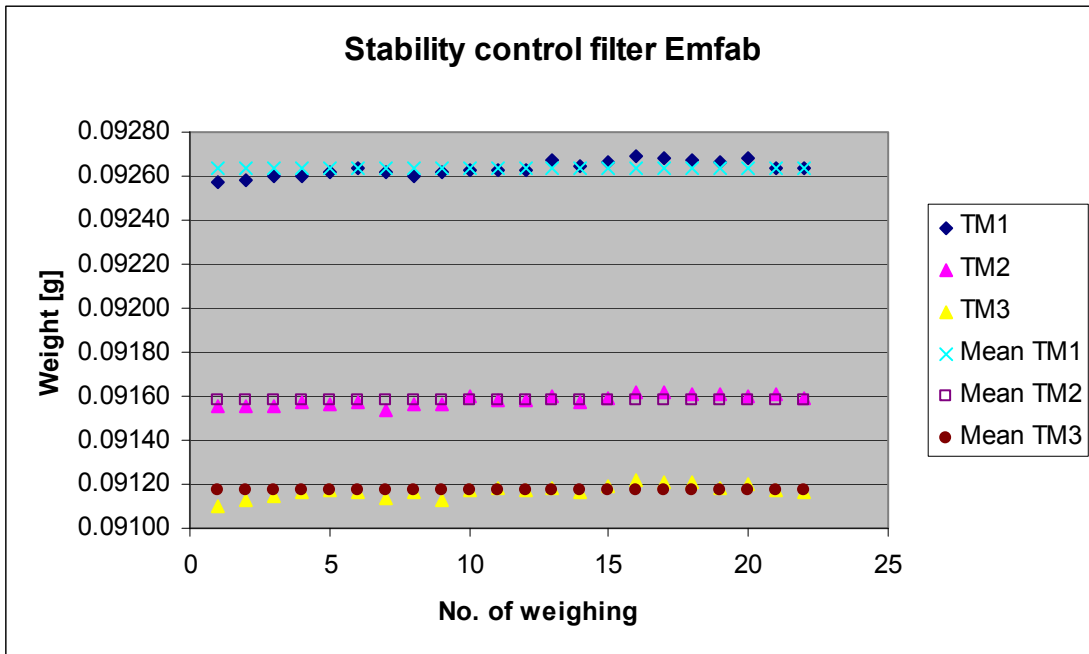

Figure 66:: Stability of the control filters



Table 37: Stability of the control filters

| Weighing No.         | Control filter No. |            |            |
|----------------------|--------------------|------------|------------|
|                      | TM1                | TM2        | TM3        |
| 1                    | 0.09257            | 0.09155    | 0.09110    |
| 2                    | 0.09258            | 0.09155    | 0.09113    |
| 3                    | 0.09260            | 0.09155    | 0.09115    |
| 4                    | 0.09260            | 0.09157    | 0.09116    |
| 5                    | 0.09262            | 0.09156    | 0.09117    |
| 6                    | 0.09264            | 0.09157    | 0.09116    |
| 7                    | 0.09262            | 0.09154    | 0.09114    |
| 8                    | 0.09260            | 0.09156    | 0.09116    |
| 9                    | 0.09262            | 0.09156    | 0.09113    |
| 10                   | 0.09263            | 0.09160    | 0.09117    |
| 11                   | 0.09263            | 0.09158    | 0.09118    |
| 12                   | 0.09263            | 0.09158    | 0.09117    |
| 13                   | 0.09267            | 0.09160    | 0.09118    |
| 14                   | 0.09265            | 0.09157    | 0.09116    |
| 15                   | 0.09266            | 0.09159    | 0.09119    |
| 16                   | 0.09269            | 0.09162    | 0.09122    |
| 17                   | 0.09268            | 0.09162    | 0.09121    |
| 18                   | 0.09267            | 0.09161    | 0.09121    |
| 19                   | 0.09266            | 0.09161    | 0.09118    |
| 20                   | 0.09268            | 0.09160    | 0.09120    |
| 21                   | 0.09264            | 0.09161    | 0.09117    |
| 22                   | 0.09264            | 0.09159    | 0.09116    |
|                      |                    |            |            |
|                      |                    |            |            |
| <b>Average</b>       | 0.09264            | 0.09158    | 0.09117    |
| <b>STD.</b>          | 3.2911E-05         | 2.4937E-05 | 2.8558E-05 |
| <b>rel. STD</b>      | 0.036              | 0.027      | 0.031      |
|                      |                    |            |            |
| <b>Median</b>        | 0.09264            | 0.09158    | 0.09117    |
| <b>lowest value</b>  | 0.09257            | 0.09154    | 0.09110    |
| <b>highest value</b> | 0.09269            | 0.09162    | 0.09122    |

Highlighted yellow = average value

Highlighted green = lowest value

Highlighted blue = highest value

## **B) UK site (Teddington)**

### **B.1 Implementation of Weighing Protocols**

NPL (National Physical Laboratory) were subcontracted to weigh filters manually for the field study. In line with EN14907 filters were kept in the weighing room for less than 28 days; the glove box used for weighing was maintained at  $(20 \pm 1) \text{ }^\circ\text{C}$  and  $(50 \pm 5) \%$ ; and filters were weighed twice before and after sampling. Table 38 summarises the conditioning and weighing timescales utilised:

*Table 38: conditioning and weighing timescales*

| <b>Pre Sampling</b>           | <b>Post Sampling</b> |
|-------------------------------|----------------------|
| Condition minimum of 48 hours | Condition 48 hours   |
| Weigh Filters                 | Weigh Filters        |
| Condition 24 hours            | Condition 24 hours   |
| Weigh Filters                 | Weigh Filters        |

At the start of each weighing session the balance was exercised to remove mechanical stiffness, and then calibrated. At the start and end of each batch of filters, a 50 and 200 mg check weight were weighed. In line with the recommendations of the UK PM Equivalence Report, filters were weighed relative to a 100 mg check weight, and not a tare filter, as the latter was shown to lose mass over time. Four filters were weighed between check weights, as the balance drift over time had been shown to be small.

The **Check weight Mass (CM)** of the filter was calculated for each weighing session using **E A.1** below:

$$CM = \frac{(m_{check,Beg} + m_{check,End})}{2} \quad \text{E A.1}$$

Where:

$M_{check,bef}$  = Mass of check weight weighed immediately prior to sample filter.

$M_{check,aft}$  = Mass of check weight weighed immediately after sample filter.

The **Relative Mass (RM)** of the filter was calculated for each weighing session using **E A.2** below:

$$RM = m_{filter} - CM \quad \text{E A.2}$$

Where:

$m_{filter}$  = Mass of sample filter

**Particulate Mass (PM)** is calculated using the following equation in accordance with EN14907.

$$PM = \left( \frac{RM_{End1} + RM_{End2}}{2} \right) - \left( \frac{RM_{Beg1} + RM_{Beg2}}{2} \right) \quad \text{E A.3}$$

Where:

Pre1 denotes weighing session 1 prior to sampling

Pre2 denotes weighing session 2 prior to sampling

Post1 denotes weighing session 1 after sampling

Post2 denotes weighing session 2 after sampling

**Pre Spread ( $S_{Pre}$ ), Post Spread ( $S_{Post}$ ) and Blank Spread ( $S_{Blank}$ )** were calculated using the following equations:

$$S_{Pre} = RM_{Anf1} - RM_{Anf2} \quad \text{E A.4}$$

$$S_{Post} = RM_{End1} - RM_{End2} \quad \text{E A.5}$$

$$S_{Blank} = \left( \frac{CM_{End2} + CM_{End1}}{2} \right) - \left( \frac{CM_{Anf2} + CM_{Anf1}}{2} \right) \quad \text{E A.6}$$

As with the UK PM Equivalence Report [11], it was not possible to weigh all filters within the 15 day timeframe suggested in EN14907. However, as filters were removed immediately from the reference samplers and placed in the refrigerator, it was not necessary to determine if  $T_{Ambient}$  exceeded 23 °C. It is felt that as 15 days was impractical for a relatively small scale field study, it is less likely to be attainable if this methodology were adopted by a National or Regional network, and as such, the methodology employed herein is representative of how the reference samplers would be operated in practice.

## B.2 Analysis of Protocols Employed

The distributions of pre and post weight for all Emfab filters weighed relative to the tare filter and checkweight are shown in Figure 67. If filters lose relative mass between weightings, then the distribution will be shifted to the right, whereas if there is a gain in the relative mass the distribution will shift to the left. EN14907 states that unsampled filters should be rejected if the difference between the masses of the two pre weightings is greater than 40 µg. Similarly, EN14907 states that sampled filters should be rejected if the difference between the masses of the two post weightings is greater than 60 µg. Filters were not rejected based on these criteria. The observed distributions of repeat mass measurements are considered unlikely to have had a significant effect on the results.

Figure 67: Distribution for Emfab filters of **(A)** Pre spread weighed relative to the checkweight and **(B)** Post spread weighed relative to the checkweight.

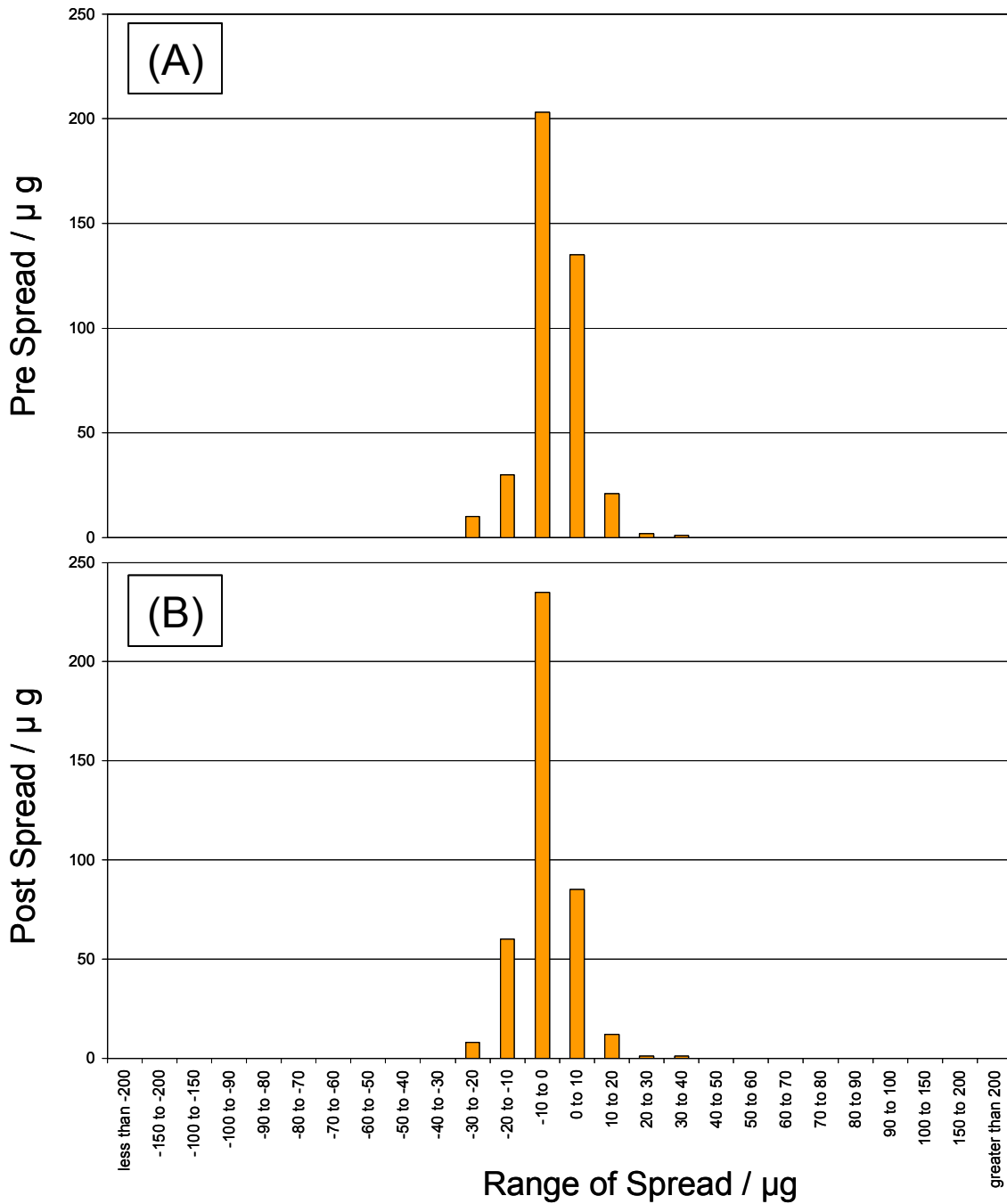

## TÜV RHEINLAND ENERGY GMBH



### ADDENDUM

Addendum to the report on performance testing, report no. 936/21209919/A of 26 March 2010 for the BAM-1020 with PM<sub>2,5</sub> pre-separator for suspended particulate matter PM<sub>2,5</sub> manufactured by Met One Instruments, Inc.

TÜV Report: 936/21243375/A  
Cologne, 21 September 2018

[www.umwelt-tuv.de](http://www.umwelt-tuv.de)



[tre-service@de.tuv.com](mailto:tre-service@de.tuv.com)

**TÜV Rheinland Energy GmbH and its Ambient Air Quality department in particular**  
is accredited for the following activities:

- Determination of emissions and ambient air quality affected by air pollutants and odorous substances,
- Inspection of correct installation, functionality and calibration of continuous emission monitoring systems including systems for data evaluation and remote monitoring of emissions
- Measurements in combustion chambers;
- Performance testing of measuring systems for continuous monitoring of emissions and air quality as well as electronic data evaluation and remote monitoring systems for emissions
- Determination of the stack height and air quality forecasts for hazardous and odorous substances;
- Determination of emissions and ambient air quality affected by noise and vibration, determination of sound power levels and noise measurements at wind turbines;

**according to EN ISO/IEC 17025.**

The accreditation will expire on 10-12-2022 and covers the scope specified in the annex to certificate D-PL-11120-02-00.

Reproduction of extracts from this test report is subject to prior written consent.

**TÜV Rheinland Energy GmbH**  
**D - 51105 Köln, Am Grauen Stein,**  
**Tel: + 49 (0) 221 806-5200, fax: +49 (0) 221 806-1349**

Addendum to the report on performance testing, report no. 936/21209919/A of 26 March 2010 for the BAM-1020 with PM<sub>2,5</sub> pre-separator for suspended particulate matter PM<sub>2,5</sub> manufactured by Met One Instruments, Inc.,  
Report No.: 936/21243375/A

**Blank page**

## Table of contents

|      |  |     |
|------|--|-----|
| 1.   | SUMMARY OVERVIEW .....   | 7   |
| 1.1  | Summary report on test results 11  |     |
| 2.   | TASK DEFINITION .....  | 16  |
| 2.1  | Nature of the test 16  |     |
| 2.2  | Objectives 16  |     |
| 3.   | DESCRIPTION OF THE AMS TESTED .....  | 18  |
| 3.1  | Measuring principle 18   |     |
| 3.2  | Functioning of the measuring system 19   |     |
| 3.3  | AMS scope and set-up 21  |     |
| 4.   | TEST PROGRAMME .....   | 38  |
| 4.1. | General 38   |     |
| 4.2  | Laboratory test 39   |     |
| 4.3  | Field test 40  |     |
| 5.   | REFERENCE MEASUREMENT METHOD .....   | 49  |
| 6.   | TEST RESULTS .....   | 50  |
| 6.1  | 1 Measuring ranges .....   | 50  |
| 6.1  | 2 negative signals .....   | 51  |
| 6.1  | 3 Zero level and detection limit (7.4.3) .....                                 | 52  |
| 6.1  | 4 Flow rate accuracy (7.4.4) .....   | 54  |
| 6.1  | 5 Constancy of sample flow rate (7.4.5) .....                                  | 56  |
| 6.1  | 6 Leak tightness of the sampling system (7.4.6) .....                          | 60  |
| 6.1  | 7 Dependence of measured value on surrounding temperature (7.4.7) .....        | 63  |
| 6.1  | 8 Dependence of measured value (span) on surrounding temperature (7.4.7) ..... | 65  |
| 6.1  | 9 Dependence of span on supply voltage (7.4.8) .....                           | 67  |
| 6.1  | 10 Effect of failure of mains voltage .....                                    | 69  |
| 6.1  | 11 Dependence of reading on water vapour concentration (7.4.9) .....           | 70  |
| 6.1  | 12 Zero checks (7.5.3) .....   | 72  |
| 6.1  | 13 Recording of operational parameters (7.5.4) .....                           | 75  |
| 6.1  | 14 Daily averages (7.5.5) .....  | 77  |
| 6.1  | 15 Availability (7.5.6) .....  | 78  |
| 6.1  | Method used for equivalence testing (7.5.8.4 & 7.5.8.8) .....                  | 80  |
| 6.1  | 16 Between-AMS uncertainty $u_{bs,AMS}$ (7.5.8.4) .....                        | 81  |
| 6.1  | 17 Expanded uncertainty of AMS results (7.5.8.5–7.5.8.8) .....                 | 87  |
| 6.1  | 17 Use of correction factors/terms (7.5.8.5–7.5.8.8) .....                     | 100 |
| 6.1  | 18 Maintenance interval (7.5.7) .....  | 106 |
| 6.1  | 19 Automatic diagnostic check (7.5.4) .....                                    | 108 |
| 6.1  | 20 Checks of temperature sensors, pressure and/or humidity sensors .....       | 110 |
| 7.   | RECOMMENDATIONS FOR USE IN PRACTICE .....                                      | 111 |
| 8.   | BIBLIOGRAPHY .....   | 113 |
| 9.   | APPENDICES .....   | 117 |



## List of tables

|           |  |     |
|-----------|--|-----|
| Table 1:  | Description of the test sites .....  | 10  |
| Table 2:  | Equivalence test results (raw data) .....  | 10  |
| Table 3:  | Instrument-related data BAM-1020 (Manufacturer's specifications) .....   | 36  |
| Table 4:  | Field test sites .....   | 41  |
| Table 5:  | Ambient conditions at the field test sites as daily averages .....   | 46  |
| Table 6:  | Results of the Grubb's test for outliers – reference PM <sub>2,5</sub> .....   | 47  |
| Table 7:  | Value pairs (reference PM <sub>2,5</sub> ) discarded from the data set following Grubb's test .....  | 48  |
| Table 8:  | Filter materials used .....  | 48  |
| Table 9:  | Zero level and detection limit PM <sub>2,5</sub> .....   | 53  |
| Table 10: | Flow rate accuracy at +5°C and +40°C .....   | 55  |
| Table 11: | Results of the flow rate checks .....  | 57  |
| Table 12: | Characteristics of the overall flow rate measurement (24h mean),<br>SN 17010 and SN 17011 .....  | 58  |
| Table 13: | Results of the leak test during the field test .....   | 62  |
| Table 14: | Dependence of the zero point on surrounding temperature, BAM-1020,<br>Deviation as µg/m <sup>3</sup> , mean from three measurements<br>S/N 17010 & S/N 17011 ..... | 64  |
| Table 15: | Dependence on surrounding temperature (internal span foil), BAM-1020,<br>deviation in %, average from 3 readings S/N 17010 & S/N 17011 .....                       | 66  |
| Table 16: | Influence of mains voltage on measured value, deviation in %<br>SN X14465 & SN X14499 .....  | 68  |
| Table 17: | Dependence of reading on water vapour concentration. dev. in µg/m <sup>3</sup> .<br>PM <sub>2,5</sub> . SN X14465 & SN X14499 .....                                | 71  |
| Table 18: | Zero point checks SN 17010 & SN 17011, PM <sub>2,5</sub> , with zero filter .....  | 73  |
| Table 19: | Determination of the availability .....  | 79  |
| Table 20: | In-between-instrument uncertainty $u_{bs}$ for the instruments<br>SN 17010 and S/N 17011, measured component PM <sub>2,5</sub> .....                               | 82  |
| Table 21: | Overview of the equivalence test for the BAM-1020 for PM <sub>2,5</sub> .....  | 90  |
| Table 22: | Between RM uncertainty $u_{bs,RM}$ for PM <sub>2,5</sub> .....   | 93  |
| Table 23: | Overview of results of the equivalence test, SN 17010 S/N 17011,<br>component PM <sub>2,5</sub> after correcting the intercept .....                               | 104 |
| Table 24: | Stability calibration weight .....   | 153 |
| Table 25: | Stability of the control filters .....   | 155 |
| Table 26: | Weighing conditions and weighing times .....   | 156 |

## List of figures

|            |   |    |
|------------|---|----|
| Figure 1:  | BAM-1020 – Illustration of sampling and measurement .....   | 20 |
| Figure 2:  | Overview of the BAM-1020 measuring system (instead of PM <sub>2,5</sub> SCC BX-807 with<br>PM <sub>2,5</sub> VSCC BX-808 (configuration for US-EPA approval) presented here)..... | 21 |
| Figure 3:  | US-EPA PM <sub>10</sub> sampling head BX-802 for BAM-1020 .....   | 22 |
| Figure 4:  | Sharp Cut Cyclone SCC BX-807 for BAM-1020 .....   | 23 |
| Figure 5:  | Sampling inlet BX-802 + SCC BX-807 .....  | 23 |
| Figure 6:  | BX-830 sample heater .....  | 24 |
| Figure 7:  | BAM-1020 measuring system .....   | 25 |
| Figure 8:  | BAM-1020 measuring system, installed in measurement cabinet<br>(2 performance test candidates + 1 candidate for experimental purposes<br>(configuration of heater) .....          | 25 |
| Figure 9:  | BX-127 vacuum pump .....  | 26 |
| Figure 10: | Front view BAM-1020, front cover opened .....   | 26 |
| Figure 11: | Display (main screen of the user interface) + soft keypad of the BAM-1020 .....   | 27 |
| Figure 12: | Menu “SETUP” .....  | 28 |
| Figure 13: | “OPERATION” menu .....  | 29 |
| Figure 14: | Screen shot “NORMAL” .....  | 29 |
| Figure 15: | “TEST” menu .....   | 30 |
| Figure 16: | Screen shot “TAPE/SELF TEST” .....  | 30 |
| Figure 17: | Communication via serial interface #1 - system menu .....   | 31 |
| Figure 18: | Typical print-out of a set of parameters for the BAM-1020 .....   | 34 |
| Figure 19: | BX-302 zero filter during application in the field .....  | 35 |
| Figure 20: | PM <sub>2,5</sub> concentrations (reference) in Teddington, summer .....  | 42 |
| Figure 21: | PM <sub>2,5</sub> concentrations (reference) in Cologne, winter .....   | 42 |
| Figure 22: | PM <sub>2,5</sub> concentrations (reference) in Bornheim, summer .....  | 43 |
| Figure 23: | PM <sub>2,5</sub> concentrations (reference) in Teddington, winter .....  | 43 |
| Figure 24: | Field test site in Teddington .....   | 44 |
| Figure 25: | Field test site Cologne, parking lot .....  | 44 |
| Figure 26: | Field test site Bornheim, motorway parking lot .....  | 45 |
| Figure 27: | Flow rate of tested instrument SN 17010 .....   | 58 |
| Figure 28: | Flow rate of tested instrument SN 17011 .....   | 59 |
| Figure 29: | Vacuum under operating conditions determined for S/N 17011, Cologne,<br>Winter .....  | 62 |
| Figure 30: | Zero drift SN 17010, measured component PM <sub>2,5</sub> .....   | 74 |
| Figure 31: | Zero drift SN 17011, measured component PM <sub>2,5</sub> .....   | 74 |
| Figure 32: | Results of the parallel measurements for instruments<br>SN 17010 / SN 17011, Measured component PM <sub>2,5</sub> , all locations .....   | 83 |
| Figure 33: | Results of the parallel measurements for instruments<br>SN 17010 / SN 17011, Measured component PM <sub>2,5</sub> , Teddington, summer .....                                      | 83 |
| Figure 34: | Results of the parallel measurements for instruments<br>SN 17010 / SN 17011, Measured component PM <sub>2,5</sub> , location: Cologne,<br>Winter .....                            | 84 |
| Figure 35: | Results of the parallel measurements for instruments SN 17010 / SN 17011,<br>Measured component PM <sub>2,5</sub> , location: Bornheim, Summer .....                              | 84 |
| Figure 36: | Results of the parallel measurements for instruments SN 17010 / SN 17011,<br>Measured component PM <sub>2,5</sub> , Teddington, winter .....                                      | 85 |
| Figure 37: | Results of the parallel measurements for instruments SN 17010 / SN 17011,<br>Measured component PM <sub>2,5</sub> , all locations, values ≥ 18 µg/m <sup>3</sup> .....            | 85 |
| Figure 38: | Results of the parallel measurements for instruments SN 17010 / SN 17011,<br>Measured component PM <sub>2,5</sub> , all locations, values < 18 µg/m <sup>3</sup> .....            | 86 |

|   |     |
|---|-----|
| Figure 39: Reference vs. tested instrument, SN 17010, component PM <sub>2,5</sub> , all sites.....  | 94  |
| Figure 40: Reference vs. tested instrument, SN 17011, component PM <sub>2,5</sub> , all sites.....  | 94  |
| Figure 41: Reference vs. tested instrument, SN 17010, component PM <sub>2,5</sub> , Teddington,<br>summer .....   | 95  |
| Figure 42: Reference vs. tested instrument, SN 17011, component PM <sub>2,5</sub> , Teddington,<br>summer .....   | 95  |
| Figure 43: Reference vs. tested instrument, SN 17010, component PM <sub>2,5</sub> , Cologne,<br>winter .....  | 96  |
| Figure 44: Reference vs. tested instrument, SN 17011, component PM <sub>2,5</sub> , Cologne, winter   | 96  |
| Figure 45: Reference vs. tested instrument, SN 17010, component PM <sub>2,5</sub> , Bornheim,<br>summer, .....  | 97  |
| Figure 46: Reference vs. tested instrument, SN 17011, component PM <sub>2,5</sub> ,<br>Bornheim, summer, .....  | 97  |
| Figure 47: Reference vs. tested instrument, SN 17010, component PM <sub>2,5</sub> ,<br>Teddington,<br>winter .....  | 98  |
| Figure 48: Reference vs. tested instrument, SN 17011, component PM <sub>2,5</sub> ,<br>Teddington, winter.....  | 98  |
| Figure 49: Reference vs. tested instrument, SN 17010, component PM <sub>2,5</sub> ,<br>values $\geq 18 \mu\text{g}/\text{m}^3$ .....  | 99  |
| Figure 50: Reference vs. tested instrument, SN 17011, component PM <sub>2,5</sub> ,<br>values $\geq 18 \mu\text{g}/\text{m}^3$ .....  | 99  |
| Figure 51: Initial announcement BAnz. of 28 July 2010, p. 2597, Chapter II Number 1.1 ..  | 114 |
| Figure 52: UBA announcement BAnz. of 26 January 2011, p. 294, Chapter IV 18 <sup>th</sup><br>Notification .....   | 115 |
| Figure 53: UBA announcement BAnz. of 29 July 2011, p. 2725, Chapter III 11 <sup>th</sup> Notification<br>115  |     |
| Figure 54: UBA announcement BAnz AT 20.07.2012 B11 chapter IV 5 <sup>th</sup> Notification .....  | 115 |
| Figure 55: UBA announcement BAnz AT 23.07.2013 B4 chapter V 4 <sup>th</sup> Notification .....  | 115 |
| Figure 56: UBA announcement BAnz AT 02.04.2015 B5 chapter IV 12 <sup>th</sup> Notification .....  | 116 |
| Figure 57: UBA announcement BAnz AT 26.03.2018 B8 chapter V 9 <sup>th</sup> Notification .....  | 116 |
| Figure 58: Stability calibration weight .....   | 152 |
| Figure 59: Stability of the control filter.....   | 154 |
| Figure 60: Scattering of the EMFAB filter for <b>(A)</b> initial weighing compared to the reference<br>weight and <b>(B)</b> back weighing compared to the reference weight. .... | 159 |

## 1. Summary Overview

Met One Instruments, Inc. commissioned TÜV Rheinland Energy GmbH to carry out performance testing of the BAM-1020 with PM<sub>2,5</sub> pre-separator for suspended particulate matter PM<sub>2,5</sub> in accordance with the following standards:

- VDI Guideline 4202, Part 1 – “Performance criteria for performance tests of automated ambient air measuring systems – Point-related measurement methods for gaseous and particulate air pollutants,” dated June 2002.
- VDI Guideline 4203, part 3 – “Testing of automated measuring systems – Test procedures for point-related ambient air measuring systems for gaseous and particulate air pollutants”, dated August 2004
- European standard EN 14907, “Ambient air quality – Standard gravimetric measurement method for the determination of PM<sub>2.5</sub> mass fraction of suspended particulate matter”, German version EN 14907: 2005
- Guide to the Demonstration of Equivalence of Ambient Air Monitoring Methods, English version of July 2009 and/or January 2010.

On the basis of the cited standards for testing, the BAM-1020 with PM<sub>2,5</sub> pre-separator for suspended particulate matter, PM<sub>2,5</sub>, has already been performance-tested and publically announce as such as follows:

- BAM-1020 with PM<sub>2,5</sub> pre-separator for suspended particulate matter, PM<sub>2,5</sub>; UBA announcement of 12 April 2010 (BAnz. p. 2597, chapter II number 1.1) – original publication
- BAM-1020 with PM<sub>2,5</sub> pre-separator, for suspended particulate matter, PM<sub>2,5</sub>; UBA announcement of 10 January 2011 (BAnz. p 294, chapter IV 18<sup>th</sup> notification) – Notification regarding a re-assessment of the leak tightness test, compliance with the requirements of the Guide to the Demonstration of Equivalence of Ambient Air Monitoring Methods, English version of January 2010
- BAM-1020 with PM<sub>2,5</sub> pre-separator for suspended particulate matter, PM<sub>2,5</sub>; UBA announcement of 15 July 2011 (BAnz. p. 2725, chapter III, 11<sup>th</sup> notification) – notification of design changes (alternative pump, touch screen display option) and new software version

- BAM-1020 with PM<sub>2,5</sub> pre-separator for suspended particulate matter, PM<sub>2,5</sub>; UBA announcement of 5 July 2012 (BAnz AT 20.07.2012 B11, chapter IV 5<sup>th</sup> notification) – Notification of design changes (re-designed back plate) and software changes
- BAM-1020 with PM<sub>2,5</sub> pre-separator for suspended particulate matter, PM<sub>2,5</sub>; UBA announcement of 3 July 2013 (BAnz AT 23.07.2013 B4, chapter V 4<sup>th</sup> notification) – notification regarding a new software version.
- BAM-1020 with PM<sub>2,5</sub> pre-separator for suspended particulate matter, PM<sub>2,5</sub>; UBA announcement of 25 February 2015 (BAnz AT 02.04.2015 B5, chapter IV 12<sup>th</sup> notification) – Notification regarding a new pressure sensor because of discontinued production
- BAM-1020 with PM<sub>2,5</sub> pre-separator for suspended particulate matter, PM<sub>2,5</sub>; UBA announcement of 21 February 2018 (BAnz AT 26.03.2018 B8, chapter V 9<sup>th</sup> notification) – notification regarding a new software version.

Standard EN 16450 “Ambient air — Automated measuring systems for the measurement of the concentration of particulate matter (PM<sub>10</sub>; PM<sub>2,5</sub>) has been available since July 2017. This standard, for the first time, harmonises requirements for the performance testing of automated measuring systems for the determination of dust concentrations (PM<sub>10</sub> and PM<sub>2,5</sub>) on a European level and will form the basis for the approval of such AMS in the future.

The present addendum presents an assessment of the BAM-1020 measuring system with PM<sub>2,5</sub> pre-separator regarding compliance with the requirements defined in standard EN 16450 (July 2017). At present, the assessment does not cover the instrument version with touch screen display (BX-970 option), as the necessary adjustments to the firmware have not yet been made for this instrument version.

As most of the performance characteristics and performance criteria defined in chapter 7 of standard EN 16450 (July 2017) have been tested and assessed already in the context of the original performance test, the majority of test results can be taken from and/or re-assessed on the basis of the original test report. It was possible to re-assess some of the original performance data for a number of test criteria. Entirely new tests were performed only for test items 7.4.4 “Flow rate accuracy”, 7.4.8 “Dependence of span on supply voltage” and 7.4.9 “Dependence of reading on water vapour concentration” in Summer 2018. A new test was also performed for test item 7.4.3 “Zero level and detection limit, lower detection limit” in order to submit the GF0.009 filter band used and qualified by Met One Instruments, Inc. since 2013 and manufactured by Whatman to testing. In the meantime, this filter band has completely replaced the type 460130 filter band manufactured by Sibata, which had been used during the original performance test.

On its publication, this addendum will become an integral part of TÜV Rheinland test report no. 936/21209919/A dated 26 March 2010 and will be available online at [www.qal1.de](http://www.qal1.de).

The BAM-1020 measuring system uses a radiometric measuring principle to determine dust concentrations. A pump sucks in ambient air via the PM<sub>2,5</sub> pre-separator (consisting of a PM<sub>10</sub> sampling head and a PM<sub>2,5</sub> Sharp Cut Cyclone). The dust-loaded sample air is then pulled to a filter tape. The determination of the mass concentration precipitated on the filter tape is then performed relying on the principle of beta absorption.

The tests were performed in the laboratory and in a several-months long field test.

The several-months long field test was performed at the sites listed in Table 1.

Table 1: Description of the test sites

|   | Teddington (UK)<br>Summer | Cologne<br>Parking lot,<br>Winter | Bornheim,<br>Motorway parking<br>area<br>Summer | Teddington (UK)<br>Winter |
|---|---------------------------|-----------------------------------|---|---------------------------|
| Period  | 07/2008–11/2008           | 12/2008 – 04/2009                 | 08/2009 – 10/2009                               | 12/2009 – 02/2010         |
| Number of<br>measurement pairs:<br>Test specimens | 83                        | 77                                | 60  | 46                        |
| Description                                       | Urban area                | Urban area                        | Rural area + motor-<br>way                      | Urban area                |
| Classification of am-<br>bient air pollution      | low to<br>average         | average<br>to high                | low to<br>average                               | average                   |

The following table provides an overview of the equivalence test performed.

Table 2: Equivalence test results (raw data)

| PM <sub>x</sub>   | Slope | Axis in-<br>tercept | All<br>Data sets<br>W <sub>CM</sub> <25 %<br>Raw data | Calibra-<br>tion<br>yes/no | All<br>Data sets<br>W <sub>CM</sub> <25%<br>cal. data |
|-------------------|-------|---------------------|---|----------------------------|---|
| PM <sub>2,5</sub> | 1.000 | 0.764               | 12.7  | yes                        | 11.7  |

\* Given the significance of the slope or the axis intercept, a calibration became necessary.



## 1.1 Summary report on test results

### Summary of test results in accordance with standard EN 16450 (July 2017)

| Performance criterion                           | Requirement  | Test result   | satis-<br>fied | Page |
|---|--|---|----------------|------|
| 1 Measuring ranges                              | 0 µg/m <sup>3</sup> to 1000 µg/m <sup>3</sup> as a 24-hour average value<br>0 µg/m <sup>3</sup> to 10,000 µg/m <sup>3</sup> as a 1-hour average value, if applicable | The measuring range is set to 0–1,000 µg/m <sup>3</sup> by default. Supplementary measuring ranges are possible up to 0–10,000 µg/m <sup>3</sup> .  | yes            | 50   |
| 2 negative signals                              | Shall not be suppressed  | Negative signals are directly displayed and correctly output by the measuring system.   | yes            | 51   |
| 3 Zero level and detection limit (7.4.3)        | Zero level: ≤ 2.0 µg/m <sup>3</sup><br>Detection limit: ≤ 2.0 µg/m <sup>3</sup>  | On the basis of testing both instruments, the zero level was determined at a maximum of 0.27 µg/m <sup>3</sup> and the detection limit at a maximum of 1.75 µg/m <sup>3</sup> .   | yes            | 52   |
| 4 Flow rate accuracy (7.4.4)                    | ≤ 2.0%   | The relative difference determined for the mean of the measuring results at +5°C and at +40°C did not exceed -1.93%.  | yes            | 54   |
| 5 Constancy of sample flow rate (7.4.5)         | ≤ 2.0% sampling flow (averaged flow)<br>≤ 5% rated flow (instantaneous flow)   | The 24h-averages deviate from their rated values by less than ± 2.0%, all instantaneous values deviate by less than ± 5%.   | yes            | 56   |
| 6 Leak tightness of the sampling system (7.4.6) | ≤ 2.0% of sample flow rate   | The maximum leak rate was determined at 0.23 l/min and was smaller than 2% of the nominal flow rate 16.67 l/min.<br><br>The criterion for passing the leak test as specified by the AMS manufacturer – maximum flow rate of 1.0 l/min – proves to be an adequate criterion for monitoring the instrument's leak tightness. The method described reliably detects potential leakages in the system (e.g. contaminations in the area of the inlet nozzle at the filter band caused by filter abrasion). | yes            | 60   |



| Performance criterion  | Requirement   | Test result   | satis-<br>fied | Page |
|--|---|---|----------------|------|
| 7 Dependence of measured value on surrounding temperature (7.4.7)        | $\leq 2.0 \mu\text{g}/\text{m}^3$   | The tested temperature range at the site of installation was +5 °C to +40 °C. Taking into account the values displayed by the instrument, we determined a maximum dependence of the zero point on the on surrounding temperature of -1.8 $\mu\text{g}/\text{m}^3$ . | yes            | 63   |
| 8 Dependence of measured value (span) on surrounding temperature (7.4.7) | $\leq 5\%$ from the value at the nominal test temperature   | The tested temperature range at the site of installation was +5 °C to +40 °C. At span point, the deviations determined did not exceed 0.3%.   | yes            | 65   |
| 9 Dependence of span on supply voltage (7.4.8)                           | $\leq 5\%$ from the value at the nominal test voltage   | Voltage variations did not result in deviations > -0.4% compared to the initial value of 230 V.   | yes            | 67   |
| 10 Effect of failure of mains voltage                                    | Instrument parameters shall be secured against loss. On return of main voltage the instrument shall automatically resume functioning. | Buffering protects all instrument parameters against loss. On return of mains voltage, the instrument returns to normal operating mode and automatically resumes measuring at the next full hour.   | yes            | 69   |

Addendum to the report on performance testing, report no. 936/21209919/A of 26 March 2010 for the BAM-1020 with PM<sub>2,5</sub> pre-separator for suspended particulate matter PM<sub>2,5</sub> manufactured by Met One Instruments, Inc., Report No. 936/21243375/A

Page 13 of 160

| Performance criterion  | Requirement   | Test result   | satis-<br>fied | Page |
|--|---|---|----------------|------|
| 11 Dependence of reading on water vapour concentration (7.4.9) | $\leq 2.0 \mu\text{g}/\text{m}^3$ in zero air   | Differences between readings determined at relative humidities of 40% and 90% did not exceed $2.0 \mu\text{g}/\text{m}^3$ . Various water vapour concentrations were not observed to cause any significant effect on zero readings. | yes            | 70   |
| 12 Zero checks (7.5.3)   | Absolute value $\leq 3.0 \mu\text{g}/\text{m}^3$  | The maximum measured value determined for PM <sub>2,5</sub> at zero point was $1.8 \mu\text{g}/\text{m}^3$ .  | yes            | 72   |
| 13 Recording of operational parameters (7.5.4)                 | Measuring systems shall be able to provide data of operational states for telemetric transmission of – at minimum – the following parameters:<br>Flow rate<br>pressure drop over sample filter (if relevant)<br>Sampling time<br>Sampling volume (if relevant);<br>Mass concentration of relevant PM fraction(s)<br>Ambient temperature<br>Exterior air pressure<br>Air temperature in measuring section<br>temperature of sampling inlet if heated inlet is used | The measuring system allows for comprehensive remote monitoring and control via various connectors (Ethernet, RS232). The instrument provides operating statuses and all relevant parameters.                                       | yes            | 75   |
| 14 Daily averages (7.5.5)                                      | The AMS shall allow for the formation of daily averages or values.  | The instrument configuration described and a measurement cycle set to 60 min allow the formation of valid daily averages based on 24 individual measurements.   | yes            | 77   |

| Performance criterion                                    | Requirement  | Test result   | satis-<br>fied | Page |
|--|--|---|----------------|------|
| 15 Availability (7.5.6)                                  | At least 90%.  | The availability for SN 17010 was 94.8%, for SN 17011 it was 95.9%.   | yes            | 78   |
| 16 Between-AMS uncertainty $u_{bs,AMS}$ (7.5.8.4)        | $\leq 2.5 \mu\text{g}/\text{m}^3$  | At no more than $1.57 \mu\text{g}/\text{m}^3$ for PM <sub>2,5</sub> , the between-AMS uncertainty $u_{bs}$ remains well below the permissible maximum of $2.5 \mu\text{g}/\text{m}^3$ .   | yes            | 81   |
| 17 Expanded uncertainty of AMS results (7.5.8.5–7.5.8.8) | $\leq 25\%$ at the level of the relevant limit value related to 24-hour average results (if required, after calibration) | The uncertainty WCM determined without applying correction factors for all observed data sets is below the determined expanded relative uncertainty $W_{dqo}$ of 25% for fine particulate matter.   | yes            | 87   |
| 17 Use of correction factors/terms (7.5.8.5–7.5.8.8)     | After the calibration:<br>$\leq 25\%$ at the level of the relevant limit value related to the 24-hour average results    | During the test, the test samples met the requirements for data quality of air quality measurements without applying a correction factor. Nevertheless, correction of the axis intercept led to a slight improvement of the expanded uncertainty for the complete data set. | yes            | 100  |

Addendum to the report on performance testing, report no. 936/21209919/A of 26 March 2010 for the BAM-1020 with PM2,5 pre-separator for suspended particulate matter PM2,5 manufactured by Met One Instruments, Inc., Report No. 936/21243375/A

Page 15 of 160

| Performance criterion  | Requirement   | Test result   | satis-<br>fied | Page |
|--|---|---|----------------|------|
| 18 Maintenance interval (7.5.7)                                    | At least 14 d   | The period of unattended operation is determined by the necessary maintenance works. It is 4 weeks.   | yes            | 106  |
| 19 Automatic diagnostic check (7.5.4)                              | Shall be possible for the AMS   | All instrument functions described in the operation manual are available and can be activated. The current operating status is continuously monitored and any issues will be flagged via a series of different warning messages. it is possible to automatically check and record the zero point and sensitivity. | yes            | 108  |
| 20 Checks of temperature sensors, pressure and/or humidity sensors | Shall be checked for the AMS to be within the following criteria<br>± 2°C<br>± 1kPa<br>± 5 % RH | It is easy to check and adjust the sensors for determining ambient temperature, ambient pressure and relative humidity on-site (filter band area).  | yes            | 110  |

## 2. Task Definition

### 2.1 Nature of the test

TÜV Rheinland Energy GmbH was commissioned by Met One Instruments, Inc. to carry out performance testing of the BAM-1020 with PM<sub>2,5</sub> pre-separator.

The BAM-1020 with PM<sub>2,5</sub> pre-separator for suspended particulate matter, PM<sub>2,5</sub>, has already been performance-tested and published as such in the Federal Gazette.

The present addendum presents an assessment of the BAM-1020 with PM<sub>2,5</sub> pre-separator regarding compliance with the requirements for automated measuring systems defined in the new standard EN 16450 (July 2017). At present, the assessment does not cover the instrument version with touch screen display (BX-970 option), as the necessary adjustments to the firmware have not yet been made for this instrument version.

### 2.2 Objectives

The measuring system is designed to determine the PM<sub>2,5</sub> fractions of dust concentrations in the range between 0–1 000 µg/m<sup>3</sup>.

The existing performance test had been performed in respect of the requirements applicable at the time of testing while at the same time taking into account the latest developments.

The test was performed on the basis of the following standards:

- VDI Guideline 4202, Part 1 – “Performance criteria for performance tests of automated ambient air measuring systems – Point-related measurement methods for gaseous and particulate air pollutants,” dated June 2002 [1]
- VDI Guideline 4203, part 3 – “Testing of automated measuring systems – Test procedures for point-related ambient air measuring systems for gaseous and particulate air pollutants”, dated August 2004 [2]
- European standard EN 14907, “Ambient air quality – Standard gravimetric measurement method for the determination of PM<sub>2,5</sub> mass fraction of suspended particulate matter”, German version EN 14907: 2005 [3]
- Guide to the Demonstration of Equivalence of Ambient Air Monitoring Methods, English version of July 2009 and/or January 2010 [4]

Since July 2017, the European Standard

- Standard EN 16450 “Ambient air — Automated measuring systems for the measurement of the concentration of particulate matter (PM<sub>10</sub>; PM<sub>2,5</sub>), German version EN 16450:2017 [8]

has been available. This standard, for the first time, harmonises requirements for the performance testing of automated measuring systems for the determination of dust concentrations (PM<sub>10</sub> and PM<sub>2,5</sub>) on a European level and will form the basis for the approval of such AMS in the future.

The present addendum presents an assessment of the BAM-1020 measuring system with PM<sub>2,5</sub> pre-separator regarding compliance with the requirements defined in standard EN 16450 (July 2017). At present, the assessment does not cover the instrument version with touch screen display (BX-970 option), as the necessary adjustments to the firmware have not yet been made for this instrument version.

As most of the performance characteristics and performance criteria defined in chapter 7 of standard EN 16450 (July 2017) have been tested and assessed already in the context of the original performance test, the majority of test results can be taken from and/or re-assessed on the basis of the original test report. It was possible to re-assess some of the original performance data for a number of test criteria. Entirely new tests were performed only for test items 7.4.4 "Flow rate accuracy", 7.4.8 "Dependence of span on supply voltage" and 7.4.9 "Dependence of reading on water vapour concentration" in Summer 2018. A new test was also performed for test item 7.4.3 "Zero level and detection limit, lower detection limit" in order to submit the GF0.009 filter band used and qualified by Met One Instruments, Inc. since 2013 and manufactured by Whatman to testing. In the meantime, this filter band has completely replaced the type 460130 filter band manufactured by Sibata, which had been used during the original performance test.

On its publication, this addendum will become an integral part of TÜV Rheinland test report no. 936/21209919/A dated 26 March 2010 and will be available online at [www.qal1.de](http://www.qal1.de).

### 3. Description of the AMS tested

#### 3.1 Measuring principle

The BAM-1020 ambient air measuring system uses beta-attenuation as its measuring principle.

The principle of the radiometric determination of mass is based on the physical law beta-ray attenuation when passing through a thin layer of material. The following equation holds:

$$c \left( \frac{\mu\text{g}}{\text{m}^3} \right) = \frac{10^6 A (\text{cm}^2)}{Q \left( \frac{\text{l}}{\text{min}} \right) \Delta t (\text{min}) \mu \left( \frac{\text{cm}^2}{\text{g}} \right)} \ln \left( \frac{I_0}{I} \right)$$

Where:

C is the particle-mass concentration  
(filter spot)

A is the sampling area for particles

Q is the sampling flow rate

$\Delta t$  is the sampling time

$\mu$  is the mass absorption coefficient  
nning (clean)

$I_0$  is the beta count rate at the begin-

I is the beta count at the end (collect)

The radiometric determination of mass is calibrated in the factory and is checked hourly as part of internal quality assurance at the zero point (clean filter spot) and at the span point (built-in span foil) during operation. Measured values at zero and at span point can easily be derived from the generated data. They can be compared with any stability requirements (drift effects) or with the nominal value for the span foil (factory setting).

### 3.2 Functioning of the measuring system

The particle sample passes through the PM<sub>2,5</sub> pre-separator, which consists of a PM<sub>10</sub> sampling inlet and a PM<sub>2,5</sub> Sharp Cut Cyclone SCC, at a flow rate of 1 m<sup>3</sup>/h and reaches the BAM-1020 analyser via the sampling tube.

During performance testing, the measuring system was operated with the BX-830 sample heater (Smart Inlet Heater).

The following process variables were used to control the sample heater:

1. Relative humidity RH at the filter tape (factory setting: 45 %)

The heater switches off as soon as the relative humidity (RH) drops below 1%.

The particles reach the measuring instrument to be loaded onto the glass fibre filter tape for radiometric measurement.

One measurement cycle (incl. automatic check of the radiometric measurement) consists of the following steps (measuring time for PM<sub>2,5</sub> set to 8 min):

1. Each cycle starts with an initial/blank measurement of a clean filter spot ( $I_0$ ). It takes 8 minutes.
2. The filter tape is transported forward over a distance of 4 dust spots and pushed under the sampling point. The sample is taken from the filter spot where  $I_0$  was previously determined. For a sampling duration of 42 min. particulate-loaded air is then sucked through that filter spot.
3. At the same time, the spot 4 positions upstream on the filter tape is submitted to radiometric measurement  $I_1$  for a duration of 8 minutes. This measurement is performed to check for potential drift effects caused by changes in external parameters such as temperature or relative moisture. The same spot is subjected to a third radiometric measurement  $I_2$  with an inserted span foil. The same spot of the filter tape is subjected to yet another  $I_{1x}$ , eight minutes before the end of the collection time in order to monitor stability of the zero point with the help of  $I_1$  and  $I_{1x}$ .



4. Once sampling is completed, the filter tape is reversed back four sampling spots and the sampled filter spot is measured radiometrically ( $I_3$ ). The calculation of the concentration completes the measurement cycle.
5. The next cycle will start again with step 1.

Figure 1 gives an overview of the sampling and measurement parts of the BAM-1020.

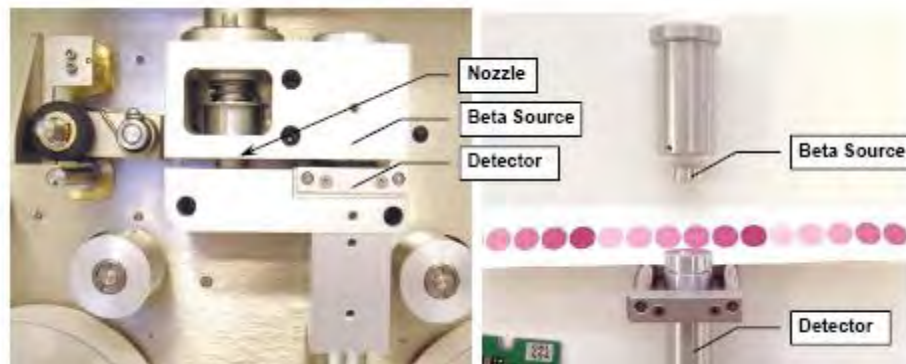

Legende:      Nozzle                      Beta Source = Beta Source  
                  Detector

Figure 1:      BAM-1020 – Illustration of sampling and measurement

During the performance test, the cycle time was set to 60 min, radiometric measurement taking 8 min.

Thus, the cycle time consists of 2 x 8 min for the radiometric measurement ( $I_0$  &  $I_3$ ) as well as approximately 1–2 min for filter tape movements. Consequently, the effective sampling time is around 42 min.

Addendum to the report on performance testing, report no. 936/21209919/A of 26 March 2010 for the BAM-1020 with PM<sub>2,5</sub> pre-separator for suspended particulate matter PM<sub>2,5</sub> manufactured by Met One Instruments, Inc., Report No. 936/21243375/A

### 3.3 AMS scope and set-up

The ambient air measuring system BAM-1020 relies on beta attenuation as its measuring principle.

The tested measuring system consists of the PM<sub>10</sub>-sampling inlet BX-802, the PM<sub>2.5</sub> Sharp Cut Cyclone SCC BX-807, the sampling tube, the sample heater BX-830, the combined pressure and temperature sensor BX-596 (incl. radiation protection shield, as an alternative the ambient temperature sensor BX-592), the vacuum pump BX-127 (or BX-125), the measuring instrument BAM-1020 (incl. glass fibre filter tape), the required connecting tubes and lines as well as adapters, the roof flange as well as the manual in English language.

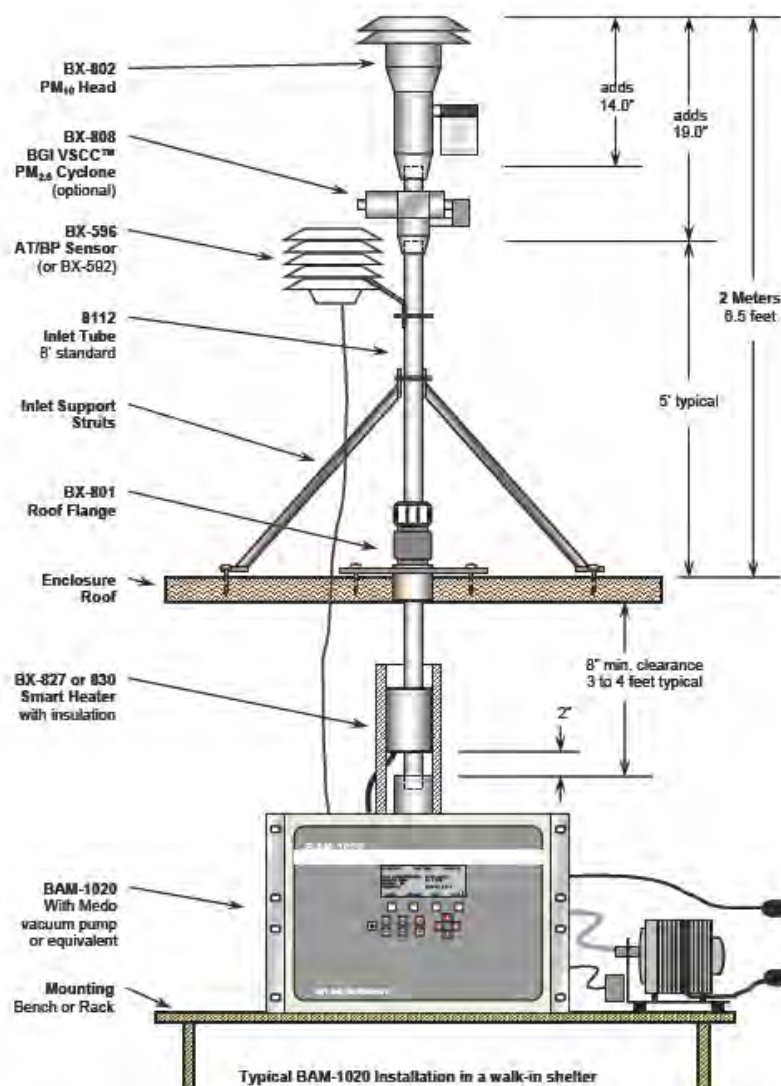

Figure 2: Overview of the BAM-1020 measuring system (instead of PM<sub>2.5</sub> SCC BX-807 with PM<sub>2.5</sub> VSCC BX-808 (configuration for US-EPA approval) presented here)

The BAM-1020 measuring system offers the possibility to connect up to 6 different sensors to the available analogue inputs. Thus, besides the combined pressure and temperature sensor BX-596 or the ambient temperature sensor BX-592, it is also possible to connect sensors for air pressure (BX-594), wind direction (BX-590), wind velocity (BX-591), humidity (BX-593) as well as solar radiation (BX-595).

A US-EPA-PM<sub>10</sub> sampling inlet (type BX-802 used for performance testing) is available. The sampling inlet serves as a pre-separator for the suspended particulate matter, PM<sub>10</sub> fraction. Directly downstream of the PM<sub>10</sub> sampling inlet, a Sharp Cut Cyclone SCC (BX-807) is used for the separation of particles in the range of 2.5 µm to 10 µm. The instruments are operated with a constant, regulated flow rate of 16.67 l/min = 1.0 m<sup>3</sup>/h.

As an alternative option, it is possible to use TSP-sampling inlets or PM<sub>10</sub> sampling inlets without SCC.



Figure 3: US-EPA PM<sub>10</sub> sampling head BX-802 for BAM-1020

Addendum to the report on performance testing, report no. 936/21209919/A of 26 March 2010 for the BAM-1020 with PM<sub>2,5</sub> pre-separator for suspended particulate matter PM<sub>2,5</sub> manufactured by Met One Instruments, Inc., Report No. 936/21243375/A



Figure 4: Sharp Cut Cyclone SCC BX-807 for BAM-1020



Figure 5: Sampling inlet BX-802 + SCC BX-807

The sampling tube connects the sampling inlet to the measuring instrument. The length of the sampling tube was 1.65 m during the test, different lengths can be manufactured with respect to the local conditions.

The BX-830 sample heater is installed at the lower end of the sampling tube (approximately 50 mm above the instrument inlet of BAM-1020). The operation of the heating systems is performed as described in chapter 3.2 Functioning of the measuring system.



Figure 6: BX-830 sample heater

The BX-127 (or BX-125) vacuum pump is connected to the measuring system proper at the end of the sampling path via a hose. The pump is controlled to regulate the operational flow with reference to the ambient conditions (ACTUAL mode).

In addition to the radiometric measuring component, the BAM-1020 measuring system contains the glass fibre filter tape incl. transport system, large parts of the pneumatic system (flow measurement by mass flow sensor), the control unit of the sample heater and all necessary electronic parts and microprocessors for the control and operation of the measuring system and for communication with the system.



Addendum to the report on performance testing, report no. 936/21209919/A of 26 March 2010 for the BAM-1020 with PM<sub>2,5</sub> pre-separator for suspended particulate matter PM<sub>2,5</sub> manufactured by Met One Instruments, Inc., Report No. 936/21243375/A



Figure 7: BAM-1020 measuring system



Figure 8: BAM-1020 measuring system, installed in measurement cabinet (2 performance test candidates + 1 candidate for experimental purposes (configuration of heater))



Figure 9: BX-127 vacuum pump



Figure 10: Front view BAM-1020, front cover opened

Addendum to the report on performance testing, report no. 936/21209919/A of 26 March 2010 for the BAM-1020 with PM2,5 pre-separator for suspended particulate matter PM2,5 manufactured by Met One Instruments, Inc., Report No. 936/21243375/A

A soft keypad in combination with a display at the front of the instrument serve to control the measuring system.

The user is can retrieve stored data, change parameters and perform several tests to verify correct operation of the measuring system. The main screen of the user display is found on the top level – here, the current time and date, last 1h-concentration value, the actual flow rate, current software version and the status of the instrument are displayed.

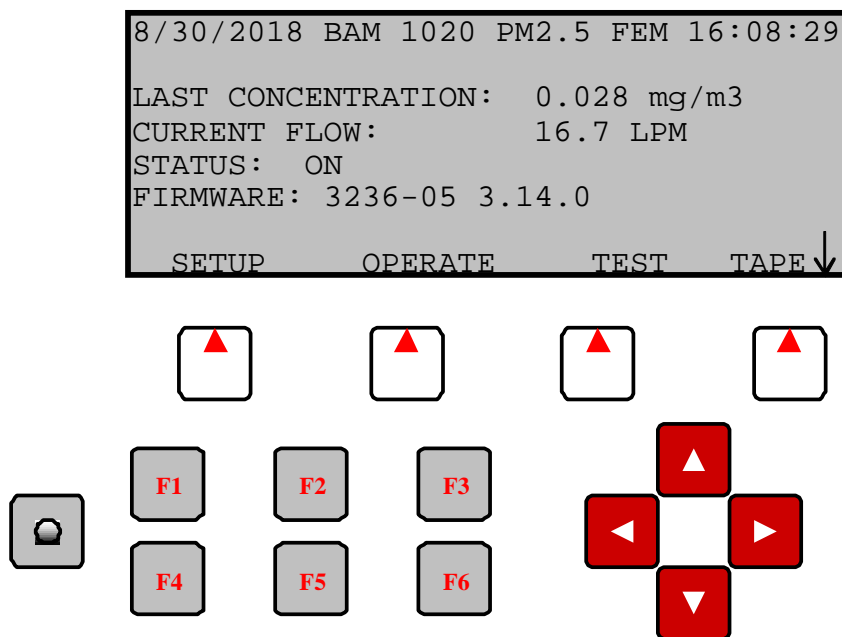

Figure 11: Display (main screen of the user interface) + soft keypad of the BAM-1020



The function keys F1 to F6 allow easy access to various functions from the main screen. For example it is possible, to access information on the last concentration values as well as measured values from other sensors (ambient temperature etc.), error messages and stored data for the measurements of the last ten days.

Starting from the main screen, it is also possible to access sub menus via the soft keys.

1. Menu „SETUP“ (Press soft key „SETUP“): The “SETUP” menu serves configuration and parameterisation of the measuring system. This menu is used to choose parameter settings such as date/time, sampling duration, measuring range, flow rate, measured value output under operating or standard conditions, or to change the password and choose settings for interfaces, external sensors and sample heater.

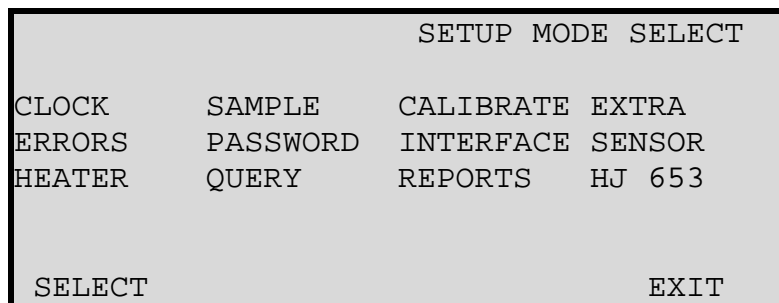

**The SETUP Menu**

Figure 12: Menu “SETUP”

2. Menu “OPERATION” (press soft key “OPERATION”): In the “OPERATION” menu , users can call up information during the operation of the measuring system. As long as the operating mode is switched “ON”, the measuring system operates according to the settings. The on-going measurement will be interrupted by switching “OFF” the operating mode, by calling up the “SETUP”, “TEST”, or “TAPE” menus during on-going operation or as a result of a severe error (e.g. tape fault).

```
11/15/2006   OPERATE MODE   14:13:07

      ↑ = ON
      ↓ = OFF
Operation Mode: ON
      Status: ON

NORMAL      INST      AVERAGE      EXIT
```

The OPERATE Menu

Figure 13: "OPERATION" menu

Recent measured values are presented in different ways in the NORMAL, INST and AVERAGE submenus. The "NORMAL" screen shows the most common form of presentation. In this screen, the user can check the most important parameters relevant for operation.

```
11/15/2006   Normal Mode   11:27:54

                                Flow(STD): 16.7 LPM
                                Flow(ACTUAL): 16.7 LPM
LAST C: 0.061 mg/m3           Press: 764 mmHg
LAST m: 0.806 mg/cm2         RH: 37 %
                                Heater: OFF
                                Delta-T: 4.2 C
STATUS: SAMPLING             EXIT
```

The NORMAL Menu

Figure 14: Screen shot "NORMAL"

3. "TEST" menu (press soft key "TEST"): Use the "TEST" menu to perform several tests for checking the hardware and components, e.g. a check of the radiometric measurement (span foil test), a check of the flow rate or a calibration of temperature and pressure sensors as well as of the flow rate.

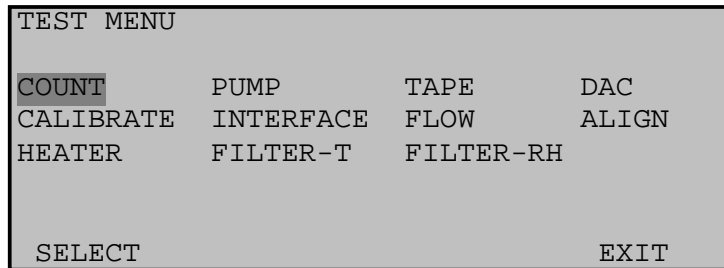

**The TEST Menu**

Figure 15: "TEST" menu

4. Menu „TAPE“ (press soft key "TAPE"): Use the "TAPE" to start an extensive self test of the measuring system at any time (this aborts the ongoing measurement). This self test takes about 4 minutes and checks various mechanic parts (e.g. filter transport system) for correct functioning, the flow rate or the state of the filter tape (tension, tape fault). In case of irregularities or excessive deviations, a "FAIL" error message is displayed which allows to start identifying the problem. "SELF TEST PASSED" will be displayed if the self test does not identify any problems. Measurement operation can be resumed. The performance of this test is generally recommended after each restart of the measurement after any interruption, in any case after a change of the filter tape.

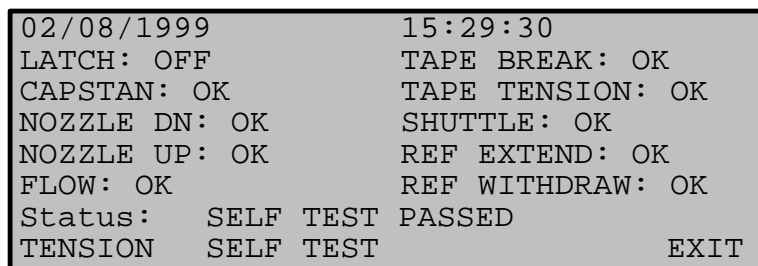

**Self-Test Status Screen**

Figure 16: Screen shot "TAPE/SELF TEST"

Addendum to the report on performance testing, report no. 936/21209919/A of 26 March 2010 for the BAM-1020 with PM2,5 pre-separator for suspended particulate matter PM2,5 manufactured by Met One Instruments, Inc., Report No. 936/21243375/A

Page 31 of 160

In addition to direct communication via keys/display, there are numerous possibilities to communicate via different analogue outputs, relays (status and alarm messages) as well the RS232 interfaces. A printer, PC and modem can be connected to the RS232 interface. The Hyperterminal software can be used for communication with the instrument.

Interface #1 serves the purposes of data transfer and communication of the instrument status. The interface is frequently used for remote control with the help of a modem.

The following system menu is available:

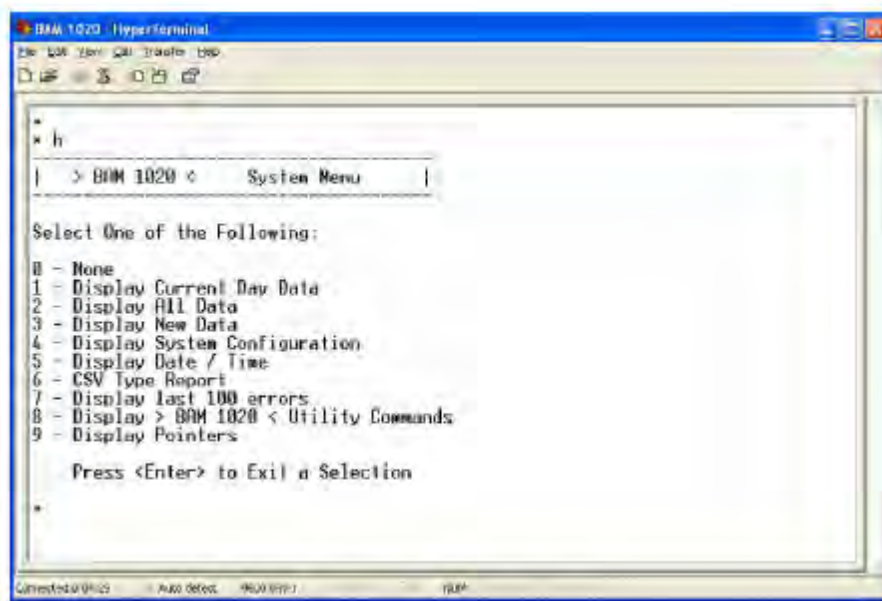

Figure 17: Communication via serial interface #1 - system menu

During the performance test, data were usually retrieved and recorded once a week. The data are suitable to be aggregated in the form of daily averages in an external spreadsheet. The following provides an example of the data thus recorded:

| Station Time   | 10<br>Conc(ug/m3) | Qtot(m3) | BP(mmH) | WS(MPS) | WS(MPS) | RH(%) | Delta(C) | AT(C) | Stab(ug) | Ref(ug) | E | U | M | I | L | R | N | F | P | D | C | T |
|----------------|-------------------|----------|---------|---------|---------|-------|----------|-------|----------|---------|---|---|---|---|---|---|---|---|---|---|---|---|
| 2/9/2009 8:00  | 16                | 0.701    | 749.4   | 5.9     | 0.7     | 16    | 22.3     | 1.9   | -0.8     | 827.2   | 0 | 0 | 0 | 0 | 0 | 0 | 0 | 0 | 0 | 0 | 0 | 0 |
| 2/9/2009 9:00  | 18                | 0.701    | 749.7   | 5.9     | 0.7     | 17    | 21.8     | 2.5   | -1.9     | 830.2   | 0 | 0 | 0 | 0 | 0 | 0 | 0 | 0 | 0 | 0 | 0 | 0 |
| 2/9/2009 10:00 | 9                 | 0.701    | 749.5   | 5.9     | 0.7     | 18    | 20.7     | 3     | -3.5     | 830.2   | 0 | 0 | 0 | 0 | 0 | 0 | 0 | 0 | 0 | 0 | 0 | 0 |
| 2/9/2009 11:00 | 9                 | 0.701    | 749.8   | 5.9     | 0.7     | 18    | 19.4     | 3.5   | -2.9     | 828     | 0 | 0 | 0 | 0 | 0 | 0 | 0 | 0 | 0 | 0 | 0 | 0 |
| 2/9/2009 12:00 | 8                 | 0.701    | 749.9   | 5.9     | 0.7     | 19    | 17.7     | 4.5   | -0.7     | 828.9   | 0 | 0 | 0 | 0 | 0 | 0 | 0 | 0 | 0 | 0 | 0 | 0 |
| 2/9/2009 13:00 | 7                 | 0.701    | 749.6   | 5.9     | 0.7     | 20    | 16.3     | 5.9   | -1.2     | 828.5   | 0 | 0 | 0 | 0 | 0 | 0 | 0 | 0 | 0 | 0 | 0 | 0 |
| 2/9/2009 14:00 | 11                | 0.7      | 749.5   | 5.9     | 0.7     | 20    | 16.1     | 6.3   | -3       | 828.4   | 0 | 0 | 0 | 0 | 0 | 0 | 0 | 0 | 0 | 0 | 0 | 0 |
| 2/9/2009 15:00 | 12                | 0.7      | 749.2   | 5.9     | 0.7     | 20    | 16.5     | 5.9   | 0        | 826.5   | 0 | 0 | 0 | 0 | 0 | 0 | 0 | 0 | 0 | 0 | 0 | 0 |
| 2/9/2009 16:00 | 11                | 0.7      | 748.8   | 5.9     | 0.7     | 20    | 16.5     | 5.9   | -3.8     | 824.5   | 0 | 0 | 0 | 0 | 0 | 0 | 0 | 0 | 0 | 0 | 0 | 0 |
| 2/9/2009 17:00 | 13                | 0.701    | 748.1   | 5.8     | 0.7     | 20    | 17.1     | 4.9   | 1.9      | 829.3   | 0 | 0 | 0 | 0 | 0 | 0 | 0 | 0 | 0 | 0 | 0 | 0 |
| 2/9/2009 18:00 | 15                | 0.701    | 747.3   | 5.8     | 0.7     | 21    | 17.3     | 4.2   | -0.2     | 828     | 0 | 0 | 0 | 0 | 0 | 0 | 0 | 0 | 0 | 0 | 0 | 0 |
| 2/9/2009 19:00 | 20                | 0.701    | 746.8   | 5.8     | 0.7     | 22    | 17       | 3.9   | 0.7      | 831.3   | 0 | 0 | 0 | 0 | 0 | 0 | 0 | 0 | 0 | 0 | 0 | 0 |
| 2/9/2009 20:00 | 18                | 0.7      | 745.9   | 5.8     | 0.7     | 24    | 17.1     | 3.1   | -3.2     | 827.3   | 0 | 0 | 0 | 0 | 0 | 0 | 0 | 0 | 0 | 0 | 0 | 0 |
| 2/9/2009 21:00 | 17                | 0.701    | 744.2   | 5.7     | 0.7     | 25    | 17       | 2.5   | -0.4     | 828.5   | 0 | 0 | 0 | 0 | 0 | 0 | 0 | 0 | 0 | 0 | 0 | 0 |

- Conc (µg/m³): Dust concentration in µg/m³, ambient conditions  
 Qtot(m³): Throughput in m³ (here at a 42 min sampling time)  
 BP(mm-Hg): Air pressure in mm-Hg  
 WS (MPS): Wind speed, not used in this case  
 RH(%): relative humidity underneath the filter tape in % - for heating control  
 Delta(C): Difference ambient temperature – temperature at the filter tape – used to control the heater, in this case  
 deactivated, no longer available from firmware version 3236-05 3.14.0  
 AT(C): Ambient temperature in °C  
 Stab(µg): Result of the internal zero measurement in µg from I<sub>1</sub> and I<sub>1x</sub> (see chapter 3.2 of this report)  
 Ref(µg): Result of the internal span foil measurement in µg/cm² from I<sub>2</sub>  
 (see chapter 3.2 of this report)  
 E, U, M, I, L, R,  
 N, F, P, D, C, T: status messages (relay), (see chapter 6.5 of the manual)

Addendum to the report on performance testing, report no. 936/21209919/A of  
26 March 2010 for the BAM-1020 with PM2,5 pre-separator for suspended  
particulate matter PM2,5 manufactured by Met One Instruments, Inc.,  
Report No. 936/21243375/A

Page 33 of 160

For information and diagnosis purposes, menu item 4 (Display System Configuration) allows to display and print the current parameterisation of the BAM-1020 measuring system (see Figure 18).

BAM 1020 Settings Report  
07/02/2018 12:38:52

Station ID, 1  
Serial Number, X14465

Firmware, 3236-05 V3.14.1

K, 00.979  
BKGD, -0.0056  
usw, 00.299  
ABS, 00.815  
Range, 1.000  
Offset, -0.015  
Clamp, -0.015  
Conc Units, mg/m3  
Conc Type, ACTUAL  
Count Time, 8  
Conc Error, FULL SCALE VALUE  
Inlet Type, PM2.5

Cv, 00.970  
Qo, 00.000  
Flow Type, ACTUAL  
Flow Setpt, 0016.7  
Std Temp, 25

Heat Mode, AUTO  
FRH Ctrl, YES  
FRH SetPt, 45  
Low Power, 6  
FRH Log, YES  
FT Log, YES

BAM Sample, 42  
MET Sample, 60  
Cycle Mode, STANDARD  
Fault Polarity, NORM  
Reset Polarity, NORM  
Maintenance, OFF

HJ 653, NO

EUMILRNFPDCT  
111111111111

AP, 000150  
Baud Rate, 9600  
Printer Report, 2  
e3, 00,000  
e4, 15,000

|             |        |        |        |        |         |        |
|-------------|--------|--------|--------|--------|---------|--------|
| Channel,    | 1,     | 2,     | 3,     | 4,     | 5,      | 6,     |
| Sensor ID,  | 4,     | 2,     | 2,     | 255,   | 255,    | 35,    |
| Channel ID, | 254,   | 254,   | 254,   | 255,   | 255,    | 254,   |
| Name,       | WS,    | WS,    | WS,    | FRH,   | FT,     | AT,    |
| Units,      | KPH,   | MPS,   | MPS,   | %,     | C,      | C,     |
| Prec,       | 1,     | 1,     | 1,     | 0,     | 1,      | 1,     |
| FS Volts,   | 1.000, | 1.000, | 1.000, | 0.500, | 2.500,  | 2.500, |
| Mult,       | 160.9, | 44.7,  | 44.7,  | 32,    | -147.1, | 95.0,  |

Offset, 0.0, 0.0, 0.0, -26, 95.8, -40.0,  
Vect/Scalar, S, S, S, S, S, S,  
Inv Slope, N, N, N, N, N, N,

Calibration, Offset, Slope,  
Flow, 0.384, 0.980,  
AT, 0.391,  
BP, -1.000,  
FRH, 0.000,  
FT, 0.000,

QUERY, 1, CONC\_A,  
Daily Range, 01:00 - 24:00  
Dynamic Range, STANDARD  
Span Check, 24 HR  
Log BP, NONE  
Log Membrane, NONE  
X3043

Figure 18: Typical print-out of a set of parameters for the BAM-1020

Addendum to the report on performance testing, report no. 936/21209919/A of 26 March 2010 for the BAM-1020 with PM<sub>2,5</sub> pre-separator for suspended particulate matter PM<sub>2,5</sub> manufactured by Met One Instruments, Inc., Report No. 936/21243375/A

Page 35 of 160

The serial interface #2 only serves as a print output and can be connected to a printer or PC. This allows the continuous recording of up-to-date information regarding measurement operation.

For external check of the zero point of the measuring system and for determination of the background value BKGD (offset correction for concentration values) according to manual chapter 7.7, a zero filter (BX-302, Zero Filter Calibration Kit) is mounted to the instrument inlet. The use of this filter allows the provision of PM-free air.



Figure 19: BX-302 zero filter during application in the field

With the available shut-off valve, it is also possible to check the leak tightness of the measuring system with the BX-302 zero filter according to the manual chapters 5.4 et seq.

For the purpose of monitoring the inlet flow rate according to the manual chapter 5.7, a BX-305 adapter (Flow Inlet Adapter Kit) is available. As this is largely the same as the BX-302 zero filter kit (apart from the HEPA filter itself), this too allows performing a leak tightness check with the help of the shut-off valve following the manual instructions in chapters 5.4 et seq.



Table 3 lists a number of important instrument characteristics of the BAM-1020 monitor for suspended particulate matter.

Table 3: Instrument-related data BAM-1020 (Manufacturer's specifications)

| <b>Dimension/weight</b>                           | <b>BAM-1020</b>   |  |
|---|---|--|
| Measuring device                                  | 310 x 430 x 400 mm / 24.5 kg (without pump)   |  |
| Sampling tube                                     | 1.65 m (additional lengths available)   |  |
| Sampling head                                     | BX-802 (US-EPA)   |  |
| <b>Power supply</b>                               | 100/115/230 V, 50/60 Hz   |  |
| <b>Power requirement</b>                          | 75 W, main unit   |  |
| <b>Ambient conditions</b>                         |   |  |
| Temperature                                       | -30 - +60 °C (manufacturer specification)<br>+5 - +40 °C during performance testing |  |
| Moisture  | non-condensing  |  |
| <b>Sample flow rate</b>                           | 16.67 l/min = 1 m <sup>3</sup> /h   |  |
| <b>Radiometry</b>                                 | <b>Light source</b>   | <sup>14</sup> C, <2,2 MBq (< 60 µCi)   |
|   | <b>Detector</b>   | Scintillation probe  |
|   | <b>Checking procedure</b>   | Hourly internal zero and span point checks (internal span foil), deviations from the target value are recorded |
| <b>Parameters of filter replacement</b>           |   |  |
| Measurement cycle (cycle time)                    | 1 min – 200 min   | Default: 60 min  |
| Measuring time radiometry                         | 4.6 or 8 min selectable   | for PM <sub>2.5</sub> : 8 min  |
| Sampling time                                     | depending on measuring time radiometry 50, 46 or 42 min                             | for PM <sub>2.5</sub> : 42 min   |
| <b>Parameters BX-830 sample heater</b>            |   |  |
| Target value for relative humidity at filter tape | Default: 45% (active during performance testing)                                    |  |

Addendum to the report on performance testing, report no. 936/21209919/A of 26 March 2010 for the BAM-1020 with PM2,5 pre-separator for suspended particulate matter PM2,5 manufactured by Met One Instruments, Inc., Report No. 936/21243375/A

|   |  |
|---|--|
| <b>Date storage capacity (internal)</b> | approx. 180 days for 1h-measured values  |
| <b>Analogue output</b>                  | 0 – 1 (10) V or 0 – 16 mA / 4 – 20 mA – can be set to 0-0.100, 0.200, 0.250, 0.500, 1.000, 2.000, 5.000 or 10.000 mg/m <sup>3</sup>                        |
| <b>Digital output</b>                   | 2 x RS 232 – interface for data transmission and remote control, c/w BX-965 report processor option (not part of the test) additional RS 232 and USB ports |
| <b>Status signals/error messages</b>    | available, for an overview see chapters 7.2 and 9.9 in the manual  |

## **4. Test programme**

### **4.1. General**

The original performance test [9] was performed using two identical instruments, type BAM-1020, serial numbers S/N 17010 and S/N 17011 in accordance with the minimum requirements specified in [1; 2; 3; 4].

The test was performed with software versions 3236-07 5.01 and 3236-07 5.0.10.

The original test comprised a laboratory test to determine the performance characteristics as well as a field test over a period of several months at various test sites in Germany.

New tests for items 6.1 4 Flow rate accuracy (7.4.4), 6.1 9 Dependence of span on supply voltage (7.4.8), 6.1 11 Dependence of reading on water vapour concentration (7.4.9) and 6.1 3 Zero level and detection limit (7.4.3) were performed with two identical BAM-1020 instruments, serial numbers X14465 and X14499.

The software version most recently announced publically is 3236-07 5.5.0. Software version 3236-05 3.14.1 was installed during the additional tests. The new software version provides new features regarding Chinese requirements, additional features and adaptations of the operational parameters to the requirements of EN 16450 [8].

In the course of the additional tests performed in summer 2018, the software was further updated to reach version 3236-05 3.14.2. Changes related to scaling sensor recording to ambient pressure as well as the data format for "Report Processor Option BX-965".

In line with the requirements of EN 15267-2, these changes have been documented and classified correctly. No effect on instrument performance was observed. A separate notification is prepared for the relevant body.

Concentrations are indicated as  $\mu\text{g}/\text{m}^3$  (operating conditions).

The present addendum presents an assessment of the BAM-1020 measuring system with PM<sub>2,5</sub> pre-separator regarding compliance with the requirements defined in standard EN 16450 [8].

In this report, the heading for each performance criterion cites the requirements according to [8] including its chapter number and wording.

## **4.2 Laboratory test**

A large portion of the laboratory test is taken from the original performance test [9]. For the present report, test results were either taken from the previous report or re-assessed.

For the following test items, additional tests had to be performed in 2018.

- Zero level and detection limit
- Flow rate accuracy
- Influence of mains voltage on measured signal
- Effect of humidity on measured value

The following devices were used to determine the performance characteristics during the laboratory tests.

- Climatic chamber (temperature range  $-20^{\circ}\text{C}$  to  $+50^{\circ}\text{C}$ , accuracy better than  $1^{\circ}\text{C}$ ).
- Isolating transformer,
- 1 mass flow meter Model 4043 (manufacturer: TSI)
- 1 reference flow meter, type BIOS Met Lab 500 (manufacturer: Mesa Lab)
- Zero filter kit BX-302 for external zero point check
- Internal span foils

The measured values were recorded internally. Stored measured values were retrieved using a hyperterminal connected to the RS232 interface.

Chapter 6 summarizes the results of the laboratory tests.

### 4.3 Field test

The field test was carried out in the context of the existing performance test [9] with 2 identical measuring systems. These were:

Instrument 1: S/N 17010  
Instrument 2: S/N 17011

For the present report, test results were either taken from the previous report or re-assessed. No further testing was required.

The following instruments were used during the field test.

- Measurement container provided by TÜV Rheinland, air-conditioned to about 20 °C
- Weather station (WS 500 manufactured by ELV Elektronik AG) for collecting meteorological data such as temperature, air pressure, humidity, wind speed, wind direction and precipitation.
- Two LVS3 reference measuring systems for PM<sub>2,5</sub> according to item 5
- 1 gas meter, dry version
- 1 mass flow meter Model 4043 (manufacturer: TSI)
- Measuring system for power consumption; Metratester 5 (manufacturer: Gossen Metrawatt)
- Zero filter kit BX-302 for external zero point check
- Internal span foils

Two BAM-1020 systems and two reference measuring systems for PM<sub>2,5</sub> were simultaneously operated for 24 h each during the field test. The reference system is a discontinuous system: the filter has to be replaced manually after sampling.

Impaction plates of the PM<sub>2,5</sub> sampling inlets were cleaned approximately every two weeks during the test period and greased with silicone grease in order to ensure reliable separation of particles. The BX-802 PM<sub>10</sub> sampling inlets and BX-807 PM<sub>2,5</sub> cyclones of the candidates<sub>2,5</sub> were cleaned every four weeks. The sampling head generally has to be cleaned following the manufacturer's instruction taking into account local concentrations of suspended particulate matter.

The flow rates of the tested and the reference instruments were checked before and after the field test as well as before and after each re-location using a dry gas meter or a mass flow controller in each case connected to the instrument's air inlet via a hose line.

### Sites of measurement and instrument installation

Measuring systems in the field test were installed in such a way that only the sampling inlets were outside the measuring cabinet on its roof. The central units of the tested instruments were positioned inside the air-conditioned measurement cabinet. The reference system (LVS3) was installed outdoors on the roof of the measurement cabinet.

The field test was performed at the following measurement sites:

Table 4: Field test sites

| No. | Measurement site                          | Period            | Description          |
|-----|---|-------------------|----------------------|
| 1   | Teddington (UK), Summer                   | 07/2008–11/2008   | Urban area           |
| 2   | Cologne, parking lot, Winter              | 12/2008 – 04/2009 | Urban area           |
| 3   | Bornheim, parking lot at motorway, Summer | 08/2009 – 10/2009 | Rural area + traffic |
| 4   | Teddington (UK), Winter                   | 12/2009 – 02/2010 | Urban area           |

Figure 11 to Figure 14 show the PM<sub>2,5</sub> concentrations measured with the reference systems at the field test sites.

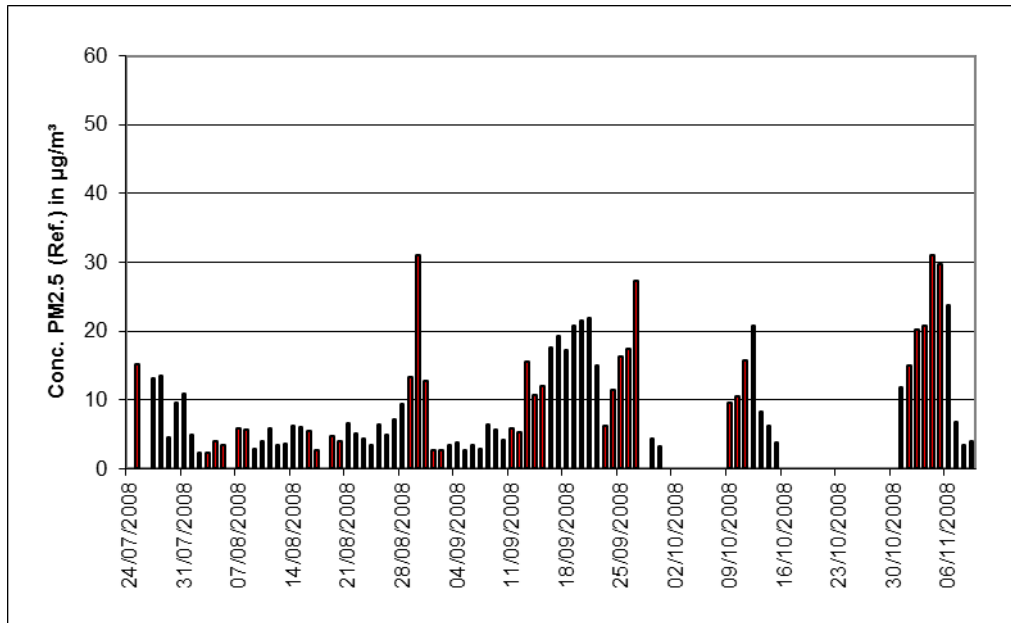

Figure 20: PM<sub>2,5</sub> concentrations (reference) in Teddington, summer

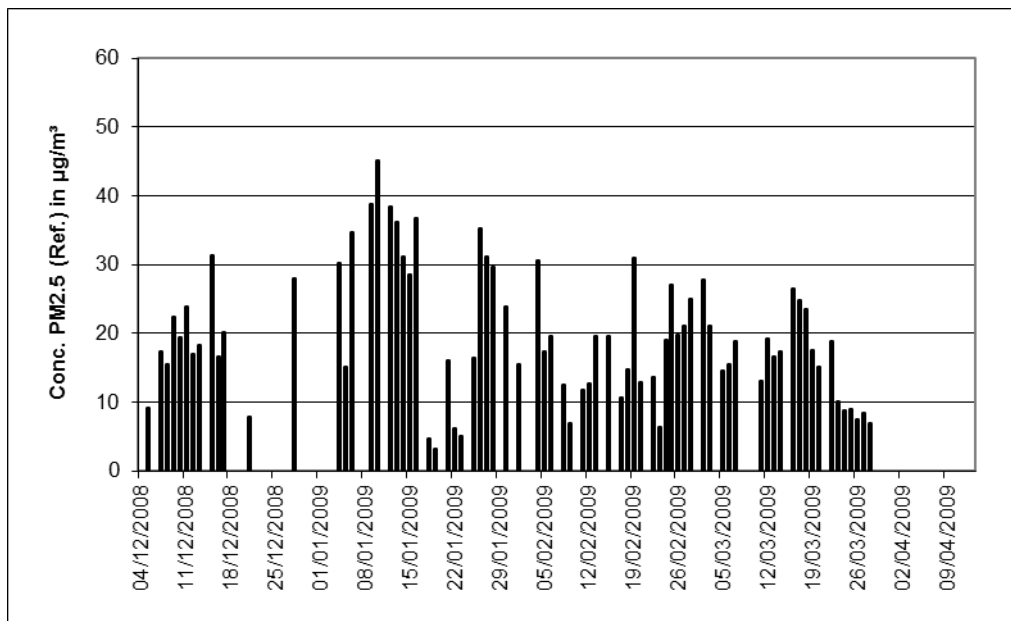

Figure 21: PM<sub>2,5</sub> concentrations (reference) in Cologne, winter

Addendum to the report on performance testing, report no. 936/21209919/A of 26 March 2010 for the BAM-1020 with PM<sub>2,5</sub> pre-separator for suspended particulate matter PM<sub>2,5</sub> manufactured by Met One Instruments, Inc., Report No. 936/21243375/A

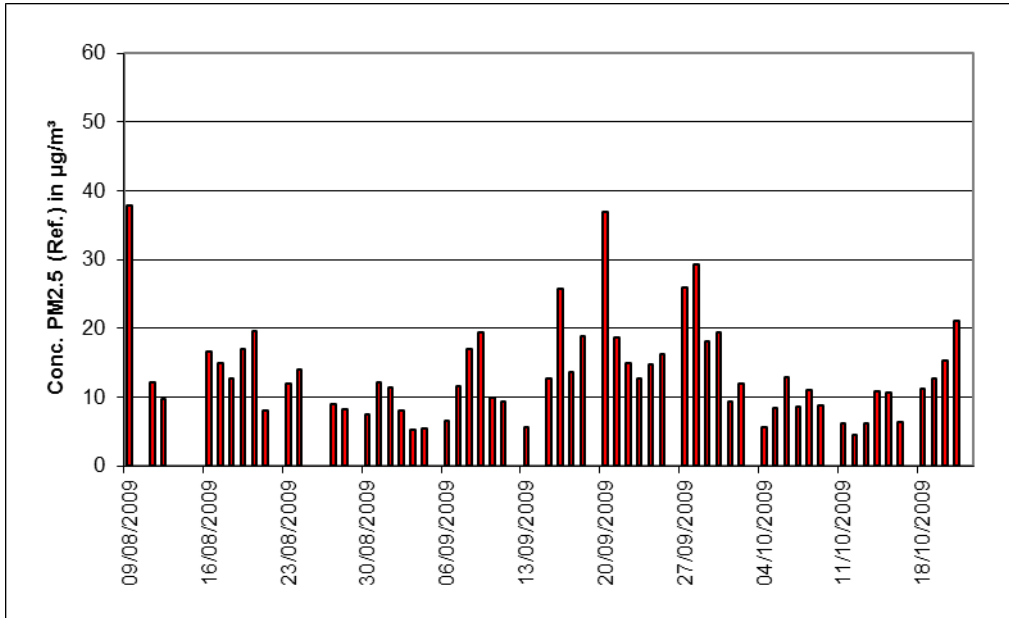

Figure 22: PM<sub>2,5</sub> concentrations (reference) in Bornheim, summer

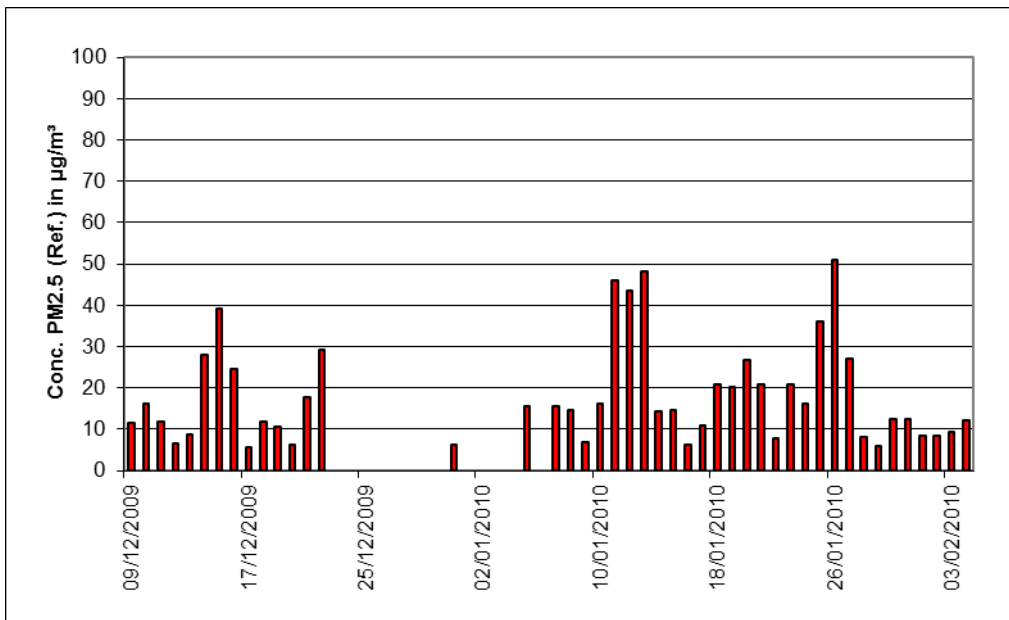

Figure 23: PM<sub>2,5</sub> concentrations (reference) in Teddington, winter



The following pictures show the measurement container at the field test sites in Teddington, Cologne (parking lot) and Bornheim (parking lot at a motorway).



Figure 24: Field test site in Teddington



Figure 25: Field test site Cologne, parking lot

Addendum to the report on performance testing, report no. 936/21209919/A of 26 March 2010 for the BAM-1020 with PM<sub>2,5</sub> pre-separator for suspended particulate matter PM<sub>2,5</sub> manufactured by Met One Instruments, Inc., Report No. 936/21243375/A

Page 45 of 160



Figure 26: Field test site Bornheim, motorway parking lot

In addition to the air quality measuring systems for monitoring suspended particulate matter, a data logger for meteorological data was installed at the container/measurement site. Data on air temperature, pressure, humidity, wind speed, wind direction and precipitation were continually measured. 30-minute mean values were recorded.

The following dimensions describe the design of the measurement cabinet as well as the position of the sampling probes.

- |   |                                 |
|---|---------------------------------|
| • Height of cabinet roof.                 | 2.50m                           |
| • Height of the sampling system for test/ | 1.13 m/0.51m above cabinet roof |
| • Reference system                        | 3.63 / 3.01 m over ground level |
| • Height of the wind vane:                | 4.5 m above ground level        |

In addition to an overview of the meteorological conditions determined during measurements at the 4 field test sites, the following Table 5 therefore provides information on the concentrations of suspended particulate matter. Meteorological data for the site in Teddington was only available after 17 September 2008. All individual values are presented in appendices 5 and 6.

Table 5: Ambient conditions at the field test sites as daily averages

|   | Teddington (UK),<br>Summer* | Cologne<br>Parking lot<br>Winter | Bornheim,<br>Motorway park-<br>ing area<br>Summer | Teddington (UK),<br>Winter |
|---|-----------------------------|----------------------------------|---|----------------------------|
| number of measurements<br>Reference                         | 81                          | 75                               | 58  | 45                         |
| <b>Ratio of PM<sub>2.5</sub> to PM<sub>10</sub><br/>[%]</b> | 22.3–83.2                   | 42.4 – 92.9                      | 40.3 – 81.8                                       | 41.6 – 90.6                |
| Range   | 53.9                        | 73.8                             | 60.5  | 70.3                       |
| Average   |                             |                                  |   |                            |
| <b>Air temperature [°C]</b>                                 |                             |                                  |   |                            |
| Range   | 4.2–15.4                    | -14 – 17.8                       | 3.3 – 25.3  | -3.7 – 9.8                 |
| Average   | 11.2                        | 3.9                              | 15.4  | 2.7                        |
| <b>Air pressure [hPa]</b>                                   |                             |                                  |   |                            |
| Range   | 984–1016                    | 971 – 1030                       | 995 – 1022  | 984 – 1037                 |
| Average   | 1000                        | 1008                             | 1010  | 1008                       |
| <b>Rel. humidity [%]</b>                                    |                             |                                  |   |                            |
| Range   | 64–95                       | 48 – 85                          | 44 – 82   | 77 – 98                    |
| Average   | 81.4                        | 71.4                             | 68.1  | 89.6                       |
| <b>Wind speed [m/s]</b>                                     |                             |                                  |   |                            |
| Range   | 0.0–1.8                     | 0.0 – 6.9                        | 0.0 – 4.4   | 0.0 – 2.4                  |
| Average   | 0.5                         | 2.0                              | 0.4   | 0.6                        |
| <b>Precipitation rate [mm/d]</b>                            |                             |                                  |   |                            |
| Range   | not available               | 0.0 – 26.9                       | 0.0 – 20.0  | 0.0 – 11.7                 |
| Average   |                             | 2.5                              | 1.9   | 1.8                        |

\* Weather data only available after 17/09/2008

### Sampling duration

Standard EN 14907 [3] fixes the sampling time at 24 h ± 1 h.

During the entire field test, all instruments were set to a sampling time of 24 h (from 10:00 to 10:00 o'clock (Cologne, Teddington) and from 7:00 to 7:00 o'clock (Bornheim)).

### Data handling

Prior to their assessment for each field test site, measured value pairs determined from reference values during the field test were submitted to a statistical Grubb's test for outliers (99%) in order to prevent distortions of the measured results from data, which evidently is implausible. Measured values pairs detected as significant outliers may be expunged from the pool of values as long as the test statistic remains above the critical value. The January 2010 version of the guideline [4] requires that no more than 2.5% of the data pairs be detected and removed as outliers.

In principle, no measured value pairs are expunged for the tested AMS, unless there are justifiable technical reasons for implausible values. During the entire test, no measured values were expunged for the tested AMS.

Table 6 presents an overview of the measured value pairs which have been detected and expunged as significant outliers (reference).

Table 6: Results of the Grubb's test for outliers – reference PM<sub>2.5</sub>

| Graph Number | Site              | Sampler                  | Number of data-pairs | Maximum Number that can be deleted | Number Identified | Number Deleted | Number of data-pairs remaining |
|--------------|-------------------|--------------------------|----------------------|------------------------------------|-------------------|----------------|--------------------------------|
| A            | Teddington Summer | PM <sub>2.5</sub> Leckel | 83                   | 2                                  | 2                 | 2              | 81                             |
| B            | Cologne Winter    | PM <sub>2.5</sub> Leckel | 77                   | 2                                  | 3                 | 2              | 75                             |
| C            | Bornheim Summer   | PM <sub>2.5</sub> Leckel | 60                   | 2                                  | 2                 | 2              | 58                             |
| D            | Teddington Winter | PM <sub>2.5</sub> Leckel | 46                   | 1                                  | 2                 | 1              | 45                             |

The following value pairs have been expunged:

Table 7: Value pairs (reference PM<sub>2,5</sub>) discarded from the data set following Grubb's test

| Location           | Date             | Reference 1 [ $\mu\text{g}/\text{m}^3$ ] | Reference 2 [ $\mu\text{g}/\text{m}^3$ ] |
|--------------------|------------------|--|--|
| Teddington, Summer | 24.07.2008       | 32.5                                     | 27.8                                     |
| Teddington, Summer | 26.07.2008       | 16.1                                     | 13.8                                     |
| Cologne, Winter    | 20 January 2009  | 11.2                                     | 8.4                                      |
| Cologne, Winter    | 03 February 2009 | 34.0                                     | 37.4                                     |
| Bornheim, Summer   | 25 August 2009   | 13.8                                     | 20.3                                     |
| Bornheim, Summer   | 22 October 2009  | 27.0                                     | 24.3                                     |
| Teddington, Winter | 06 January 2010  | 13.5                                     | 16.0                                     |

### Filter handling – Mass measurement

The following filters were used during performance testing:

Table 8: Filter materials used

| Measuring device          | Filter material, type                    | Manufacturer |
|---------------------------|--|--------------|
| Reference devices<br>LVS3 | Emfab <sup>™</sup> , $\varnothing$ 47 mm | Pall         |

Filter handling was performed in compliance with EN 14907.

The methods used for processing and weighting filters and for weighing are described in detail in appendix 2 to this report.

## **5. Reference Measurement Method**

The following instruments were used during the field test in accordance with EN 14907:

1. as PM<sub>2.5</sub> reference system: Low Volume Sampler LVS3  
Manufacturer: Engineering office Sven Leckel, Leberstraße  
63, Berlin, Germany  
Date of manufacture: 2007  
PM<sub>2.5</sub> sampling inlet

During the tests, two reference systems for PM<sub>2.5</sub> were operated in parallel with the flow controlled at 2.3 m<sup>3</sup>/h. Under normal conditions the accuracy of flow control is < 1% of the nominal flow rate.

For the LVS3 low volume sampler, the rotary vane vacuum pump takes in sample air via the sampling inlet. The volumetric flow is measured between the filter and the vacuum pump with the help of a measuring orifice. The air taken in flows from the pump via a separator for the abrasion of the rotary vane to the air outlet.

After sampling has been completed, the electronics display the sample air volume in standard and operating m<sup>3</sup>.

The PM<sub>2.5</sub> concentrations were determined by dividing the quantity of suspended particulate matter on each filter determined in the laboratory with a gravimetric method by the corresponding throughput of sample air flow as operating m<sup>3</sup>.



## **6. Test results**

### **6.1 1 Measuring ranges**

*The measuring ranges shall meet the following requirements:*

*0 µg/m<sup>3</sup> to 1000 µg/m<sup>3</sup> as a 24-hour average value*

*0 µg/m<sup>3</sup> to 10,000 µg/m<sup>3</sup> as a 1-hour average value, if applicable*

### **6.2 Equipment**

The test of this criterion did not require any further equipment.

### **6.3 Testing**

It was tested whether the measuring system's upper limit of measurement meets the requirements .

### **6.4 Evaluation**

The following measuring ranges can be set at the measuring system:  
0 – 0.100, 0 – 0.200, 0 – 0.250, 0 – 0.500, 0 – 1.000, 0 – 2.000, 0 – 5.000 as well as  
0 – 10.000 mg/m<sup>3</sup>.

During the performance test, the measuring range was set to 0–1.000 mg/m<sup>3</sup> = 0–  
1,000 µg/m<sup>3</sup>.

Measuring range:                      0 –1,000 µg/m<sup>3</sup> (standard)

### **6.5 Assessment**

The measuring range is set to 0–1,000 µg/m<sup>3</sup> by default. Supplementary measuring ranges  
are possible up to 0–10,000 µg/m<sup>3</sup>.

Criterion satisfied?    yes

### **6.6 Detailed presentation of test results**

Not required for this performance criterion.

Addendum to the report on performance testing, report no. 936/21209919/A of 26 March 2010 for the BAM-1020 with PM2,5 pre-separator for suspended particulate matter PM2,5 manufactured by Met One Instruments, Inc., Report No. 936/21243375/A

Page 51 of 160

## **6.1 2 negative signals**

*Negative signals shall not be suppressed.*

## **6.2 Equipment**

The test of this criterion did not require any further equipment.

## **6.3 Testing**

The possibility of displaying negative signals was tested both in the laboratory and in the field test.

## **6.4 Evaluation**

The measuring system is able to output negative signals both via its display and its data outputs.

## **6.5 Assessment**

Negative signals are directly displayed and correctly output by the measuring system.

Criterion satisfied? yes

## **6.6 Detailed presentation of test results**

Not required for this performance criterion.



### 6.1 3 Zero level and detection limit (7.4.3)

*Zero level:*  $\leq 2.0 \mu\text{g}/\text{m}^3$

*Detection limit:*  $\leq 2.0 \mu\text{g}/\text{m}^3$

### 6.2 Equipment

Zero filter for zero checks

### 6.3 Testing

The zero level and detection limit of the AMS shall be determined by measurement of 15 24-hour average readings obtained by sampling from zero air (no rolling or overlapped averages are permitted). The mean of these 15 24-h averages is used as the zero level. The detection limit is calculated as 3,3 times the standard deviation of the 15 24h-averages.

The zero level and the detection limit were determined with zero filters installed at the AMS inlets of instruments with SN X14465 and SN X14499 during normal operation. Air free of suspended particulate matter is applied over a period of 15 days for a duration of 24h each.

### 6.4 Evaluation

The detection limit  $X$  is calculated from the standard deviation  $s_{x0}$  of the measured values sucking air free from suspended particulate matter through both test specimen. It is equal to the standard deviation of the average  $\bar{x}_0$  of the measured values  $x_{0i}$  multiplied by 3.3 for each test specimen.

$$X = 3.3 \cdot s_{x0} \quad \text{where } s_{x0} = \sqrt{\frac{1}{n-1} \cdot \sum_{i=1,n} (x_{0i} - \bar{x}_0)^2}$$

### 6.5 Assessment

On the basis of testing both instruments, the zero level was determined at a maximum of  $0.27 \mu\text{g}/\text{m}^3$  and the detection limit at a maximum of  $1.75 \mu\text{g}/\text{m}^3$ .

Criterion satisfied? yes

Addendum to the report on performance testing, report no. 936/21209919/A of 26 March 2010 for the BAM-1020 with PM<sub>2,5</sub> pre-separator for suspended particulate matter PM<sub>2,5</sub> manufactured by Met One Instruments, Inc., Report No. 936/21243375/A

## 6.6 Detailed presentation of test results

Table 9: Zero level and detection limit PM<sub>2,5</sub>

|   |                   | Device SN X14465 | Device SN X14499 |
|---|-------------------|------------------|------------------|
| Number of values n                                  |                   | 15               | 15               |
| Average of the zero values (Zero level) $\bar{x}_0$ | µg/m <sup>3</sup> | 0.27             | 0.23             |
| Standard deviation of the values $s_{x0}$           | µg/m <sup>3</sup> | 0.42             | 0.53             |
| Detection limit x                                   | µg/m <sup>3</sup> | <b>1.37</b>      | <b>1.75</b>      |

Schedule 1 in the annex contains the individual measured values for the determination of the zero level and detection limit.

#### **6.1 4 Flow rate accuracy (7.4.4)**

*The relative difference between the two values determined for the flow rate shall be ≤ 2.0%.*

*The relative difference between the two values determined for the flow rate shall fulfil the following performance requirements:*

≤ 2.0%

- *at 5°C and 40°C for installations in an air-conditioned environment by default*
- *at minimum and maximum temperatures specified by the manufacturer if these deviate from the default temperatures.*

#### **6.2 Equipment**

Climatic chamber for the temperature range of +5°C to +40°C; a reference flow meter in accordance with item 4 was provided.

#### **6.3 Testing**

The BAM-1020 measuring system operates at a flow rate of 16.67 l/min (1 m<sup>3</sup>/h).

At a temperature of +5 °C and +40 °C the flow rate was measured with the help of a reference flow meter for both measuring systems by taking 10 measurements over a period of 1h at the flow rate specified by the manufacturer for operation. The measurements were performed at equal intervals throughout the measurement period.

#### **6.4 Evaluation**

Averages were calculated from the 10 measured values determined at each temperature and deviations from the operating flow rate determined.

#### **6.5 Assessment**

The relative difference determined for the mean of the measuring results at +5°C and at +40°C did not exceed -1.93%.

Criterion satisfied? yes

Addendum to the report on performance testing, report no. 936/21209919/A of 26 March 2010 for the BAM-1020 with PM2,5 pre-separator for suspended particulate matter PM2,5 manufactured by Met One Instruments, Inc., Report No. 936/21243375/A

## 6.6 Detailed presentation of test results

Table 10 summarises the results of the flow rate measurements.

Table 10: Flow rate accuracy at +5°C and +40°C

|                         |       | Device SN X14465 | Device SN X14499 |
|-------------------------|-------|------------------|------------------|
| Nominal value flow rate | l/min | 16.67            | 16.67            |
| Mean value at 5°C       | l/min | 16.41            | 16.35            |
| Dev. from nominal value | %     | -1.54            | -1.93            |
| Mean value at 40°C      | l/min | 16.87            | 16.88            |
| Dev. from nominal value | %     | 1.18             | 1.24             |

Schedule 2 in the annex contains the individual measured values for the determination of the flow rate accuracy.

### **6.1 5 Constancy of sample flow rate (7.4.5)**

*The instantaneous flow rate and the flow rate averaged over the sampling period shall fulfil the performance requirements below.*

*≤ 2.0% sample flow (instantaneous flow)*

*≤ 5% rated flow (instantaneous flow)*

### **6.2 Equipment**

For this test, an additional reference flow meter in accordance with item 4 was provided.

### **6.3 Testing**

The BAM-1020 measuring system operates at a flow rate of 16.67 l/min (1 m<sup>3</sup>/h).

The sample flow rate was calibrated before the first field test and checked with the help of a mass flow controller at every new field test site and re-adjusted when necessary.

To determine the constancy of the sample flow rate, the flow rate was recorded and evaluated with the help of a mass flow meter over a period of 24h (= 24 measurement cycles, 5-second values for the flow rate).

### **6.4 Evaluation**

The average, standard deviation as well as the maximum and minimum values were determined from the measured values for the flow rate.

## 6.5 Assessment

Table 11 presents the results of the flow rate checks performed at every field test site.

Table 11: Results of the flow rate checks

| Flow rate check before: | SN 17010 |                      | SN 17011 |                      |
|-------------------------|----------|----------------------|----------|----------------------|
| Field test site:        | [l/min]  | Dev. from target [%] | [l/min]  | Dev. from target [%] |
| Teddington, Summer      | 16.3     | -2.4                 | 16.5     | -1.2                 |
| Cologne, Winter         | 16.8     | 0.6                  | 16.7     | 0.0                  |
| Bornheim, Summer        | 16.7     | 0.0                  | 16.9     | 1.2                  |
| Teddington, Winter      | 16.5     | -1.2                 | 16.6     | -0.6                 |

The charts illustrating the constancy of the sample flow rate demonstrate that all measured values determined during sampling deviate from their respective rated values by less than  $\pm 5\%$ . At 16.67 l/min, the deviation of the 24h-mean for the overall flow rate also remains well below the required maximum of  $\pm 2.0\%$  from the rated value.

The 24h-averages deviate from their rated values by less than  $\pm 2.0\%$ , all instantaneous values deviate by less than  $\pm 5\%$ .

Criterion satisfied? yes

## 6.6 Detailed presentation of test results

Table Table 12 lists the characteristics determined for the flow rate. Figure 27 to Figure 28 provide a chart of the flow rate measurement for both instruments - SN 17010 and SN 17011.

Table 12: Characteristics of the overall flow rate measurement (24h mean), SN 17010 and SN 17011

|                         |       | Device SN 17010 | Device SN 17011 |
|-------------------------|-------|-----------------|-----------------|
| Mean value              | l/min | 16.49           | 16.63           |
| Dev. from nominal value | %     | -1.07           | -0.26           |
| Standard deviation      | l/min | 0.09            | 0.10            |
| Minimum value           | l/min | 16.20           | 16.30           |
| Maximum value           | l/min | 16.85           | 16.85           |

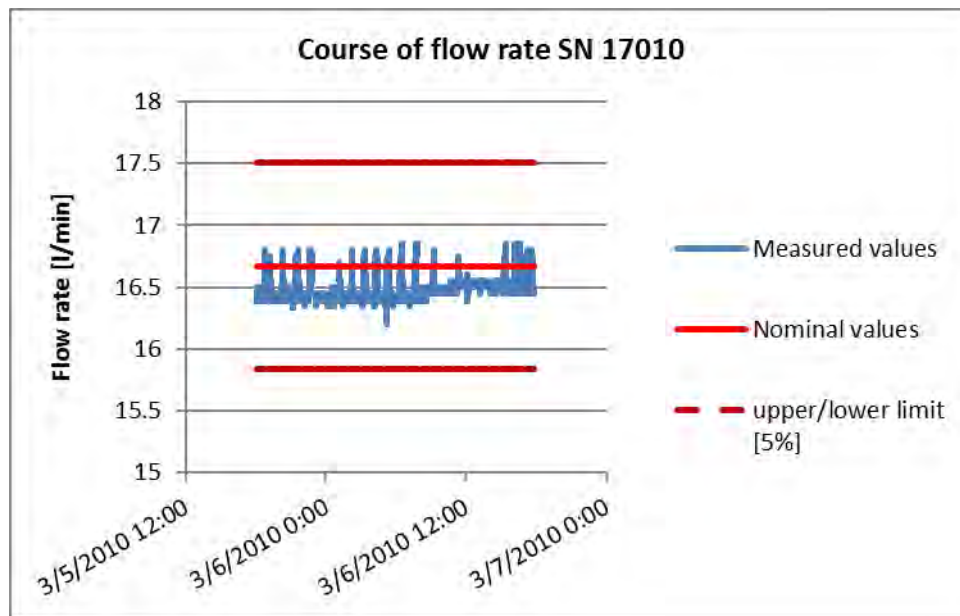

Figure 27: Flow rate of tested instrument SN 17010

Addendum to the report on performance testing, report no. 936/21209919/A of 26 March 2010 for the BAM-1020 with PM2,5 pre-separator for suspended particulate matter PM2,5 manufactured by Met One Instruments, Inc., Report No. 936/21243375/A

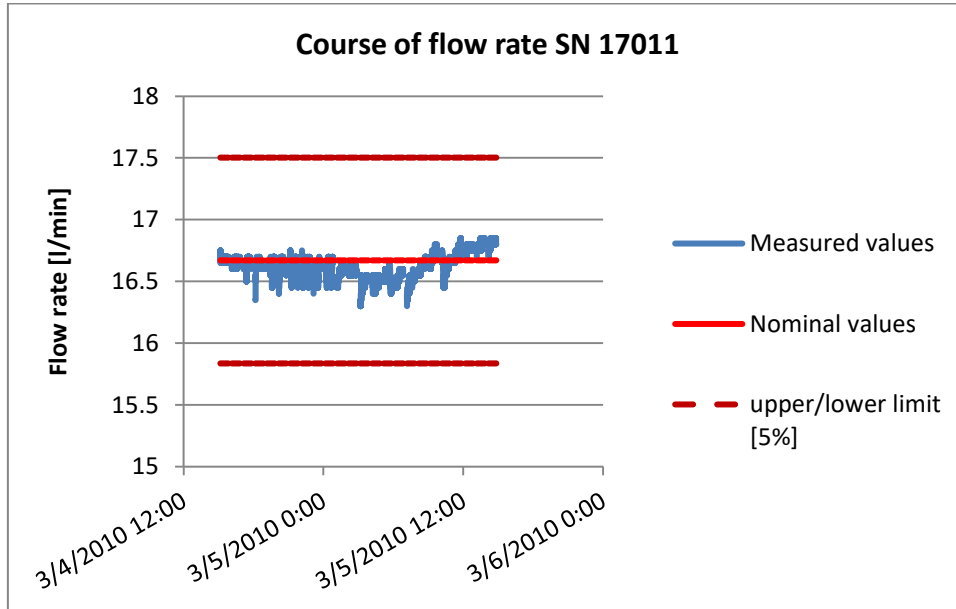

Figure 28: Flow rate of tested instrument SN 17011



## **6.1 6 Leak tightness of the sampling system (7.4.6)**

*Leakage shall not exceed 2.0% of the sample flow rate or else meet the AMS manufacturer's specifications in complying with the required data quality objectives (DQO).*

## **6.2 Equipment**

BX-302 zero filter kit or BX-305 inlet adapter

## **6.3 Testing**

To determine the leak rate, the BX-305 inlet adapter was attached to the inlet of the sampling tube and the adapter's ball valve was closed slowly. The leak rate was determined from the difference between the flow rate when the pump was switched off (zero point of flow rate measurement) and the measured flow rate with a sealed instrument inlet.

This procedure was performed three times during the field test in Cologne.

It is recommended to test the instrument's tightness with the procedure described above once a month.

## **6.4 Evaluation**

The leak rate was determined from the difference between the flow rate when the pump was switched off (zero point of flow rate measurement) and the measured flow rate with a sealed instrument inlet.

The maximum of three observed leak rates was determined.

Under the test conditions described, the manufacturer allows a maximum leak rate of 1 l/min as a completely sealed instrument results in a very strong vacuum inside the measuring system which significantly exceeds any vacuum that could be created during normal operation by filter loading.

However, this maximum can be converted to a value which can realistically occur in normal operation. It is recommended to use the determined, converted leak rate for the evaluation of the measuring system.

The Hagen-Poiseuille law applies to laminar flowing liquids and gases in a tube. It describes the quantity of the medium flowing through a tube (with the length  $l$  and the radius  $r$ ) per unit of time as follows:

$$\dot{V} = \frac{dV}{dt} = \frac{\pi r^4}{8\eta} \frac{\Delta p}{l}$$

For the present situation, the following may be derived:

1. The flow length  $l$ , the radius  $r$  and the dynamic viscosity  $\eta$  (for gases no pressure dependence in the range up to 10 bar) remain constant.
2. Thus, the leak rate  $\dot{V}$  is immediately proportional to the differential pressure  $\Delta p$ .
3. During the leak tightness test, the nominal differential pressure is at 438 mbar when using the BX-127 pump (MEDO 230 V, 50 Hz).
4. Differential pressure in normal operation is at around 200–250 mbar. (see exemplary evaluation for SN 17011 from the performance test, Cologne, winter – Figure 29).
5. Accordingly, the displayed leak rate exceeds the actual rate at least by the factor  $438/250 = 1.75$ .
6. Applying this factor to the data obtained results in the following leak rate related to the standard flow rate of 16.67 l/min.

Gerät1: 1.0%

System 2 1.4%

## 6.5 Assessment

The maximum leak rate was determined at 0.23 l/min and was smaller than 2% of the nominal flow rate 16.67 l/min.

The criterion for passing the leak test as specified by the AMS manufacturer – maximum flow rate of 1.0 l/min – proves to be an adequate criterion for monitoring the instrument's leak tightness. The method described reliably detects potential leakages in the system (e.g. contaminations in the area of the inlet nozzle at the filter band caused by filter abrasion).

Criterion satisfied? yes

### 6.6 Detailed presentation of test results

Table 13 lists the result from the leak test.

Table 13: Results of the leak test during the field test

|          | Flow<br>(Pump off) | Flow<br>(Pump on, inlet closed) |                 |                 | Max.<br>value | Max.value<br>divided by<br>1.75 | Part target<br>value | Max. acceptable<br>leak rate acc.<br>Manufacturer |
|----------|--------------------|---------------------------------|-----------------|-----------------|---------------|---------------------------------|----------------------|---|
|          |                    | 1<br>(01.12.08)                 | 2<br>(26.01.09) | 3<br>(16.02.09) |               |                                 |                      |   |
|          | l/min              | l/min                           | l/min           | l/min           | l/min         | %                               | l/min                |   |
| SN 17010 | 0                  | 0.1                             | 0.3             | 0               | 0.3           | 0.17                            | 1.03                 | 1.0   |
| SN 17011 | 0                  | 0.1                             | 0.4             | 0.3             | 0.4           | 0.23                            | 1.03                 | 1.0   |

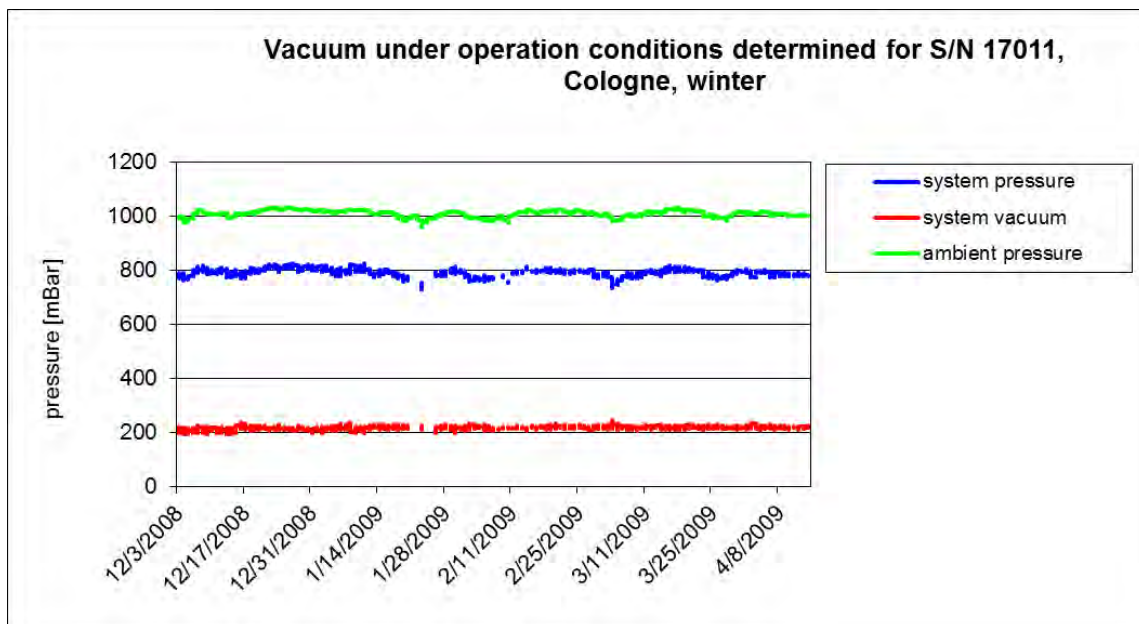

Figure 29: Vacuum under operating conditions determined for S/N 17011, Cologne, Winter

The average vacuum is 218 mbar, the maximum is at 245 mbar and the minimum is at 196 mbar.

## 6.1 7 Dependence of measured value on surrounding temperature (7.4.7)

*The differences found shall comply with the performance criteria given below.*

*Zero point*

*≤ 2.0 µg/m<sup>3</sup>*

- *between 5°C and 40°C by default, for installations in an air-conditioned environment.*
- *at minimum and maximum temperatures specified by the manufacturer if these deviate from the default temperatures.*

## 6.2 Equipment

Climatic chamber adjusted to a temperature range of +5 °C to +40 °C, zero filter kit BX-802 for zero point check.

## 6.3 Testing

The dependence of the zero reading on the surrounding temperature was determined at the following temperatures (within the specifications of the manufacturer):

- a) at a nominal temperature  $T_{S,n} = +20\text{ °C}$ ;
- b) at a minimum temperature  $T_{S,1} = +5\text{ °C}$ ;
- c) at a maximum temperature  $T_{S,2} = +40\text{ °C}$ .

The complete measuring systems were operated inside a climatic chamber in order to evaluate the influence of ambient temperature on the zero point.

Sample air, free of suspended particles, was supplied to the two candidate systems after fitting two zero filters at the AMS inlet in order to perform zero point checks.

The tests were performed in the temperature sequence  $T_{S,n} — T_{S,1} — T_{S,n} — T_{S,2} — T_{S,n}$ .

Readings were recorded at zero point after an equilibration period of at least 24h for every temperature step (3 readings each).

## 6.4 Evaluation

Measured values for the concentrations of the individual readings were read and evaluated.

In order to exclude any possible drift due to factors other than temperature, the measurements at  $T_{S,n}$  were averaged.

The differences between readings at both extreme temperatures and  $T_{S,lab}$  were determined.

## 6.5 Assessment

The tested temperature range at the site of installation was +5 °C to +40 °C. Taking into account the values displayed by the instrument, we determined a maximum dependence of the zero point on the on surrounding temperature of -1.8 µg/m<sup>3</sup>.

Criterion satisfied? yes

## 6.6 Detailed presentation of test results

Table 14: Dependence of the zero point on surrounding temperature, BAM-1020, Deviation as µg/m<sup>3</sup>, mean from three measurements S/N 17010 & S/N 17011

| Temperature<br>°C  | SN 17010                            |   | SN 17011                            |   |
|--------------------|-------------------------------------|---|-------------------------------------|---|
|                    | Measured value<br>µg/m <sup>3</sup> | Deviation to mean<br>value at 20°C<br>µg/m <sup>3</sup> | Measured value<br>µg/m <sup>3</sup> | Deviation to mean<br>value at 20°C<br>µg/m <sup>3</sup> |
| 20                 | 0.2                                 | -0.9  | -1.0                                | 0.1   |
| 5                  | 1.6                                 | 0.5   | -0.3                                | 0.8   |
| 20                 | 0.6                                 | -0.5  | -1.1                                | 0.0   |
| 40                 | 0.3                                 | -0.8  | -2.9                                | -1.8  |
| 20                 | 2.5                                 | 1.4   | -1.3                                | -0.2  |
| Mean value at 20°C | 1.1                                 | -   | -1.1                                | -   |

Schedule 3 in the annex contains the individual measuring results.

## 6.1 8 Dependence of measured value (span) on surrounding temperature (7.4.7)

*The differences found shall comply with the performance criteria given below.*

*Sensitivity of the measuring system (span):*

*≤ 5% from the value at the nominal test temperature*

- *between 5°C and 40°C by default, for installations in an air-conditioned environment.*
- *at minimum and maximum temperatures specified by the manufacturer if these deviate from the default temperatures.*

## 6.2 Equipment

climatic chamber adjusted to +5 °C to +40 °C, internal span foil used to check the span point.

## 6.3 Testing

The dependence of AMS sensitivity (span) on the surrounding temperature was determined at the following temperatures (within the specifications of the manufacturer):

- a) at a nominal temperature  $T_{S,n} = +20\text{ °C}$ ;
- b) at a minimum temperature  $T_{S,1} = +5\text{ °C}$ ;
- c) at a maximum temperature  $T_{S,2} = +40\text{ °C}$ .

For the purpose of testing the dependence of the AMS sensitivity on the surrounding temperature, the complete measuring system was operated in the climatic chamber without the outdoor rack.

For the purpose of span checks the sensitivity of the internal span foil was verified for the tested instruments SN 17010 and SN 17011 in order to test the stability of the sensitivity.

The tests were performed in the temperature sequence  $T_{S,n} - T_{S,1} - T_{S,n} - T_{S,2} - T_{S,n}$ .

Readings were recorded at zero point after an equilibration period of at least 6h for every temperature step (3 readings each).

## 6.4 Evaluation

Measured values for the internal span foil were recorded at different temperatures and evaluated.

In order to exclude any possible drift due to factors other than temperature, the measurements at  $T_{S,n}$  were averaged.

The differences between readings at both extreme temperatures and  $T_{S,lab}$  were determined.

## 6.5 Assessment

The tested temperature range at the site of installation was +5 °C to +40 °C. At span point, the deviations determined did not exceed 0.3%.

Criterion satisfied? yes

## 6.6 Detailed presentation of test results

Table 15: Dependence on surrounding temperature (internal span foil), BAM-1020, deviation in  
%, average from 3 readings  
S/N 17010 & S/N 17011

| Temperature<br>°C  | SN 17010                                |   | SN 17011                                |   |
|--------------------|---|---|---|---|
|                    | Measured value<br>[µg/cm <sup>3</sup> ] | Deviation to mean<br>value at 20°C<br>% | Measured value<br>[µg/cm <sup>3</sup> ] | Deviation to mean<br>value at 20°C<br>% |
| 20                 | 829.7                                   | 0.0                                     | 822.5                                   | -0.1                                    |
| 5                  | 829.3                                   | 0.0                                     | 822.5                                   | -0.1                                    |
| 20                 | 829.5                                   | 0.0                                     | 822.8                                   | 0.0                                     |
| 40                 | 831.1                                   | 0.2                                     | 825.2                                   | 0.3                                     |
| 20                 | 829.5                                   | 0.0                                     | 823.6                                   | 0.1                                     |
| Mean value at 20°C | 829.6                                   | -                                       | 823.0                                   | -                                       |

Schedule 3 in the annex contains the results from 3 individual measurements.

Addendum to the report on performance testing, report no. 936/21209919/A of 26 March 2010 for the BAM-1020 with PM2,5 pre-separator for suspended particulate matter PM2,5 manufactured by Met One Instruments, Inc., Report No. 936/21243375/A

Page 67 of 160

## **6.1 9 Dependence of span on supply voltage (7.4.8)**

*The differences found shall comply with the performance criteria given below.*

*Sensitivity of the measuring system (span):*

*≤ 5% from the value at the nominal test voltage*

## **6.2 Equipment**

Isolating transformer, internal span foil for span checks

## **6.3 Testing**

In order to test the dependence of span on supply voltage, supply voltage was reduced to 195 V starting from 230 V, it was then increased to 253 V via an intermediary step of 230 V.

For the purpose of span checks, the sensitivity of the internal span foil was verified for the tested instruments SN X14465 and SN X14499 in order to test the stability of the sensitivity.

## **6.4 Evaluation**

At span point, the percentage change of the measured value determined for every step related to the starting point at 230 V was considered.

## **6.5 Assessment**

Voltage variations did not result in deviations > -0.4% compared to the initial value of 230 V.

Criterion satisfied? yes



## 6.6 Detailed presentation of test results

Table 16 shows a summary of the test results.

Table 16: Influence of mains voltage on measured value, deviation in %  
SN X14465 & SN X14499

| Supply voltage<br>V | SN X14465              |   | SN X14499              |   |
|---------------------|------------------------|---|------------------------|---|
|                     | Measured value<br>[mg] | Deviation to start<br>value at 230 V<br>% | Measured value<br>[mg] | Deviation to start<br>value at 230 V<br>% |
| 230                 | 0.815                  | -   | 0.826                  | -   |
| 195                 | 0.816                  | 0.2                                       | 0.828                  | 0.3                                       |
| 230                 | 0.817                  | 0.3                                       | 0.822                  | -0.4                                      |
| 253                 | 0.816                  | 0.2                                       | 0.827                  | 0.1                                       |
| 230                 | 0.815                  | 0.0                                       | 0.824                  | -0.2                                      |

Schedule 4 in the annex contains the individual results.

## 6.1 10 Effect of failure of mains voltage

*Instrument parameters shall be secured against loss.  
On return of main voltage the instrument shall automatically resume functioning.*

## 6.2 Equipment

Not required for this performance criterion.

## 6.3 Testing

A simulated failure in the mains voltage served to test whether the instrument remained fully functional and reached operation mode on return of the mains voltage.

## 6.4 Evaluation

In the event of a failure in mains voltage, the measuring system automatically starts a new measuring cycle at the next full hour and thus resumes normal operation.

## 6.5 Assessment

Buffering protects all instrument parameters against loss. On return of mains voltage, the instrument returns to normal operating mode and automatically resumes measuring at the next full hour.

Criterion satisfied? yes

## 6.6 Detailed presentation of test results

Not applicable.

### **6.1 11 Dependence of reading on water vapour concentration (7.4.9)**

*The largest difference in readings between 40% and 90% relative humidity shall fulfil the performance criterion stated below:  
≤ 2.0 µg/m<sup>3</sup> in zero air when cycling relative humidity from 40% to 90% and back.*

### **6.2 Equipment**

Climatic chamber c/w humidity control for the range between 40% and 90% relative humidity, zero filter for zero checks

### **6.3 Testing**

The dependence of reading on water vapour concentration in the sample air was determined by feeding humidified zero air in the range between 40% and 90% relative humidity. To this effect, the measuring system was operated in the climatic chamber and the relative humidity of the entire surrounding atmosphere was controlled. Sample air, free of suspended particles was supplied to the instruments SN X14465 and SN X14499 after fitting two zero filters at either AMS inlet in order to perform zero point checks.

After stabilisation of relative humidity and the concentration values, a reading over an 24h-averaging period at 40% relative humidity was recorded. Relative humidity was then increased to 90% at a constant pace. The time needed until an equilibrium was reached (ramp) and the measured value over an averaging time of 24h at 90% relative humidity were recorded. Subsequently, humidity was decreased to 40% at a constant pace. Again, the time needed until an equilibrium was reached (ramp) and the reading over an averaging time of 24h at 40% relative humidity were recorded.

### **6.4 Evaluation**

The measured value for the zero level of 24-hour individual measurements at stable humidity levels were obtained and assessed. The characteristic concerned is the largest difference in µg/m<sup>3</sup> between values in the range of 40% to 90% relative humidity.

### **6.5 Assessment**

Differences between readings determined at relative humidifies of 40% and 90% did not exceed 2.0 µg/m<sup>3</sup>. Various water vapour concentrations were not observed to cause any significant effect on zero readings.

Criterion satisfied? yes

Addendum to the report on performance testing, report no. 936/21209919/A of 26 March 2010 for the BAM-1020 with PM2,5 pre-separator for suspended particulate matter PM2,5 manufactured by Met One Instruments, Inc., Report No. 936/21243375/A

## 6.6 Detailed presentation of test results

Table 17: Dependence of reading on water vapour concentration. dev. in  $\mu\text{g}/\text{m}^3$ . PM<sub>2.5</sub>.  
SN X14465 & SN X14499

| rel. Humidity     | SN X14465                |                             | SN X14499                |                             |
|-------------------|--------------------------|-----------------------------|--------------------------|-----------------------------|
|                   | Measured value           | Deviation to previous value | Measured value           | Deviation to previous value |
| %                 | $\mu\text{g}/\text{m}^3$ | $\mu\text{g}/\text{m}^3$    | $\mu\text{g}/\text{m}^3$ | $\mu\text{g}/\text{m}^3$    |
| 40                | 0.4                      | -                           | -0.1                     | -                           |
| 90                | -1.6                     | -2.0                        | -1.8                     | -1.7                        |
| 40                | -0.5                     | 1.2                         | -1.2                     | 0.6                         |
| Maximum deviation | -2.0                     |                             | -1.7                     |                             |

## **6.1 12 Zero checks (7.5.3)**

*During the tests, the absolute measured value of the AMS shall not exceed the following criterion:*

*Absolute value  $\leq 3.0 \mu\text{g}/\text{m}^3$*

## **6.2 Equipment**

Zero filter for zero checks

## **6.3 Testing**

As part of the field test the checks were performed over a total of 20 months.

As part of regular checks about every month (incl. at the beginning and at the end of the tests at each location), the measuring systems were operated with zero filters fitted to the AMS inlets over a period of at least 24h and zero readings were evaluated.

## **6.4 Evaluation**

During the tests, the absolute measured value of the AMS at zero point defined at  $3.0 \mu\text{g}/\text{m}^3$  shall not be exceeded.

## **6.5 Assessment**

The maximum measured value determined for PM<sub>2,5</sub> at zero point was  $1.8 \mu\text{g}/\text{m}^3$ .

Criterion satisfied? yes

## **6.6 Detailed presentation of test results**

Table 18 shows the determined measured values for the zero point in  $\mu\text{g}/\text{m}^3$ .

Figure 30 to Figure 31 illustrate the zero drift observed during the test period.

Addendum to the report on performance testing, report no. 936/21209919/A of 26 March 2010 for the BAM-1020 with PM2,5 pre-separator for suspended particulate matter PM2,5 manufactured by Met One Instruments, Inc., Report No. 936/21243375/A

Table 18: Zero point checks SN 17010 & SN 17011, PM<sub>2.5</sub>, with zero filter

| Date       | SN 17010          |  | Date       | SN 17011          |  |
|------------|-------------------|--|------------|-------------------|--|
|            | Measured Value    | Measured value (absolute)<br>> 3.0 µg/m <sup>3</sup> |            | Measured Value    | Measured value (absolute)<br>> 3.0 µg/m <sup>3</sup> |
|            | µg/m <sup>3</sup> |  |            | µg/m <sup>3</sup> |  |
| 7/24/2008  | 1.4               | ok   | 7/24/2008  | -1.3              | ok   |
| 8/18/2008  | -0.8              | ok   | 8/18/2008  | -1.1              | ok   |
| 9/23/2008  | 1.0               | ok   | 9/23/2008  | -0.6              | ok   |
| 10/16/2008 | 1.8               | ok   | 10/16/2008 | -0.8              | ok   |
| 11/10/2008 | -0.1              | ok   | 11/10/2008 | -0.2              | ok   |
| 12/3/2008  | -1.2              | ok   | 12/3/2008  | -0.3              | ok   |
| 1/7/2009   | 0.4               | ok   | 1/7/2009   | 0.7               | ok   |
| 2/2/2009   | -0.7              | ok   | 2/2/2009   | -0.4              | ok   |
| 3/4/2009   | -1.5              | ok   | 3/4/2009   | -1.1              | ok   |
| 4/2/2009   | 0.2               | ok   | 4/2/2009   | 0.4               | ok   |
| 8/13/2009  | 0.1               | ok   | 8/13/2009  | -1.3              | ok   |
| 9/14/2009  | -0.1              | ok   | 9/14/2009  | 0.3               | ok   |
| 10/23/2009 | -0.1              | ok   | 10/23/2009 | -0.2              | ok   |
| 12/7/2009  | 0.9               | ok   | 12/7/2009  | 0.5               | ok   |
| 1/4/2010   | 0.4               | ok   | 1/4/2010   | 0.8               | ok   |
| 2/5/2010   | -0.3              | ok   | 2/5/2010   | 1.6               | ok   |

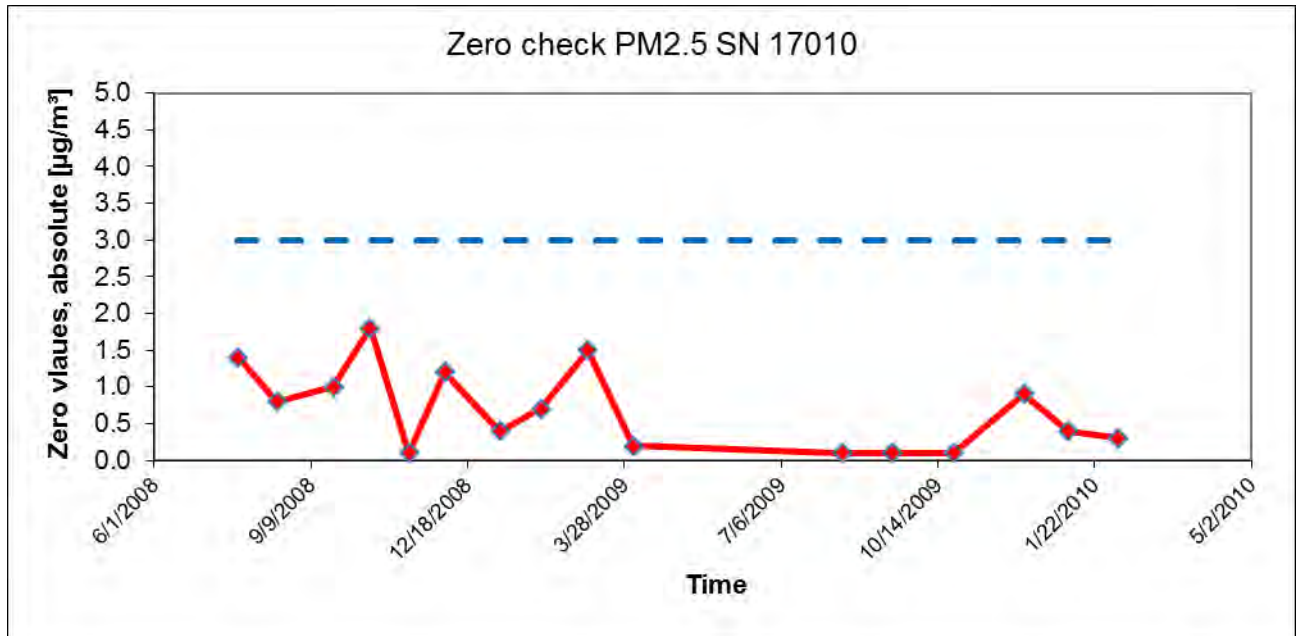

Figure 30: Zero drift SN 17010, measured component PM<sub>2.5</sub>

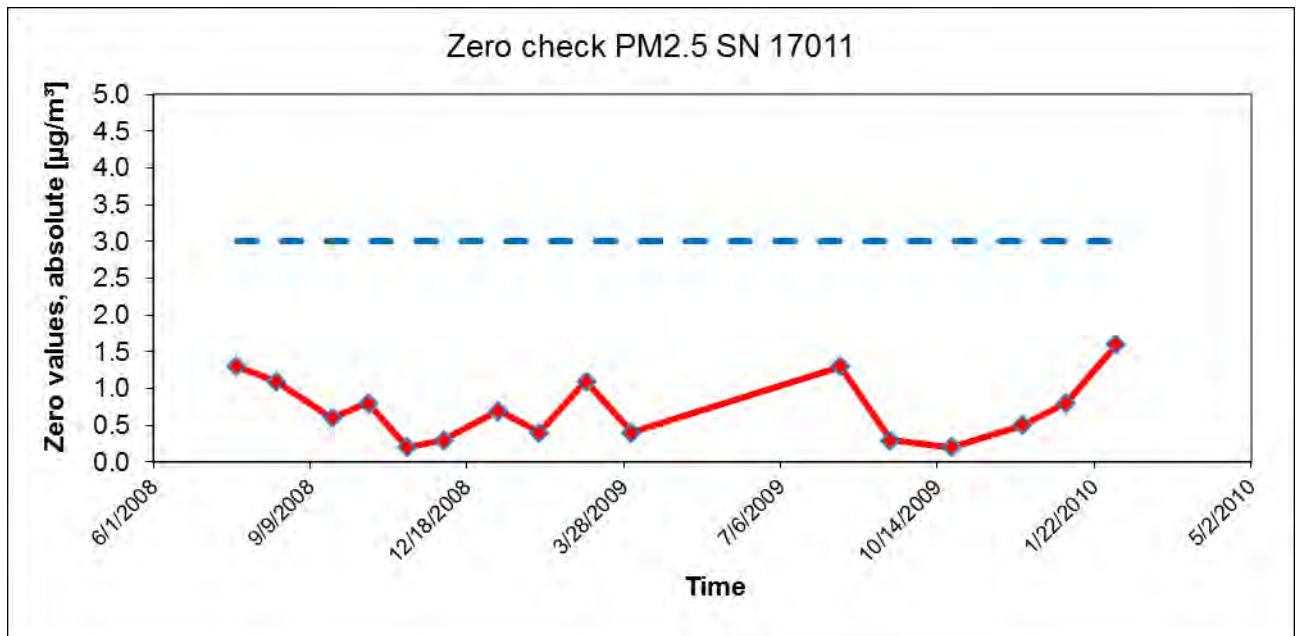

Figure 31: Zero drift SN 17011, measured component PM<sub>2.5</sub>

## 6.1 13 Recording of operational parameters (7.5.4)

*Measuring systems shall be able to provide data of operational states for telemetric transmission of – at minimum – the following parameters:*

- *Flow rate;*
- *Pressure drop over sample filter (if relevant);*
- *Sampling time;*
- *Sampling volume (if relevant);*
- *Mass concentration of relevant PM fraction(s);*
- *Ambient temperature,*
- *Exterior air pressure,*
- *Air temperature in measuring section,*
- *Temperature of the sampling inlet if a heated inlet is used;*

*Results of automated/functional checks, where available, shall be recorded.*

## 6.2 Equipment

Modem, PC for data acquisition (RS 232-host-device)

## 6.3 Testing

The measuring system allows for comprehensive remote monitoring and control e.g. via an RS232 interface. It can communicate measured values and status information via the Bavaria-Hesse protocol.

It is possible to communicate the operating statuses and relevant parameters including:

- Concentration measured values from the previous test cycle,
- Sampled volume,
- Sample flow rate
- Ambient temperature and pressure,
- Internal measurement of zero point (STAB) and span point (REF)
- Pressure drop across the filter band (5min flow file),
- It is also possible to configure relative humidity in the area of filter band (monitoring / control of heating) or other meteorological parameters.
- 

The parameters “sampling duration” (set via the cycle time) and “temperature of the sample inlet” are irrelevant to the measuring system.

Remote monitoring and control is easily possible via routers or modems.

Access to the instrument and the data during the performance test was ensured by terminal software.



#### **6.4 Evaluation**

The measuring system allows for comprehensive remote monitoring and control via various connectors (Ethernet, RS232). The instrument provides operating statuses and all relevant parameters.

#### **6.5 Assessment**

The measuring system allows for comprehensive remote monitoring and control via various connectors (Ethernet, RS232). The instrument provides operating statuses and all relevant parameters.

Criterion satisfied? yes

#### **6.6 Detailed presentation of test results**

Not applicable.

## 6.1 14 Daily averages (7.5.5)

*The AMS shall allow for the formation of daily averages or values.*

## 6.2 Equipment

For this test, a clock was additionally provided.

## 6.3 Testing

We verified whether the measuring system allows for the formation of daily averages.

## 6.4 Evaluation

By default, the measuring system operates with a measurement cycle of 60 min. After each measurement cycle, the filter tape is moved forward by one position. The data of each measurement cycle are stored and are available to the user for further processing. Furthermore, the measuring system allows the formation of a 24 h average, which is output in the daily protocol via the serial interface.

During the performance test, the cycle time was set to 60 min, radiometric measurements taking 8 min each.

Thus, the cycle time consists of 2 x 8 min for the radiometric measurement ( $I_0$  &  $I_3$ ) as well as approximately 1–2 min for filter tape movements. Accordingly, the sampling time per hour is 42 min.

Thus, the available sampling time per measurement cycle corresponds to approx. 70 % of the total cycle time. The results of the field test in accordance with item 6.1 17 Expanded uncertainty of AMS results (7.5.8.5–7.5.8.8) in this report show that reproducibility of the test specimen compared to the reference method for this instrument configuration was clearly demonstrated and thus daily averages can reliably be formed.

## 6.5 Assessment

The instrument configuration described and a measurement cycle set to 60 min allow the formation of valid daily averages based on 24 individual measurements.

Criterion satisfied? yes

## 6.6 Detailed presentation of test results

Not applicable.

## 6.1 15 Availability (7.5.6)

*The availability of the measuring system shall be at least 90%.*

## 6.2 Equipment

Not required for this performance criterion.

## 6.3 Testing

The start and end times at each of the four field test sites from the initial test marked the start and end time for the availability test. Proper operation of the measuring system was verified during every on-site visit (usually every working day). This daily check consisted of plausibility checks on the measured values, status signals and other relevant parameters. Time, duration and nature of any error in functioning are recorded.

The total time during the field test in which valid measurement data of ambient air concentrations were obtained was used for calculating availability. Time needed for scheduled calibrations and maintenance (cleaning; change of consumables) should not be included.

Availability is calculated as

$$A = \frac{t_{\text{valid}} + t_{\text{cal,maint}}}{t_{\text{field}}}$$

Where:

$t_{\text{valid}}$  is the time during which valid data have been collected;

$t_{\text{cal,maint}}$  is the time spent for scheduled calibrations and maintenance;

$t_{\text{field}}$  is the total duration of the field test.

## 6.4 Evaluation

Table 19 establishes the operation, maintenance and outage times. During the field test, the measuring systems were operated for a total of 373 measuring days (see annex 5). This period includes a total of 12 days in zero filter operation, audits as well as days which had to be disregarded because of changing to the zero filter (again, see annex 5).

Outages caused by external events not attributed to the measuring system occurred on 06 August 2008 and 07 August 2008 (48h due to power failure). Furthermore, all measuring systems were out of operation between 17/10/2008 and 20/10/2008 (for SN 17011 additionally 12/08/2009 (repair of SN 17010)). This reduces the total time of operation to 367 (SN 17010) and 366 measuring days (SN 17011).

The following errors in functioning were observed:

A tape fault caused 3 days of outage for S/N 17010. Moreover irregularities (spikes) in the concentration and in the stability values (internal zero check) were recorded at the beginning of tests in Bornheim. It turned out that the detector (PMT) of the measuring system caused these spikes although the reason remains unknown. The detector was replaced on site on 12 August 2009. The parameters for instrument calibration implemented in the system remained unaffected. In sum, the issues with the detector resulted in a total outage of 4 days.

System no. 17011 experienced one day of outage because the filter tape got stuck. Two additional days of outage were the result of a filter fault.

No further errors in functioning were observed:

Addendum to the report on performance testing, report no. 936/21209919/A of 26 March 2010 for the BAM-1020 with PM<sub>2,5</sub> pre-separator for suspended particulate matter PM<sub>2,5</sub> manufactured by Met One Instruments, Inc., Report No. 936/21243375/A

Page 79 of 160

Regular cleaning of the sampling inlets in the maintenance interval, filter tape replacement (approx. every 2 months) and regular checks of the flow rate and the leak tightness each resulted in outages of less than 1 h per instrument (outage time = 1 cycle). These tasks cause down times of less than 1h per check (16 times during testing) and did not require daily averages to be discarded.

## 6.5 Assessment

The availability for SN 17010 was 94.8%, for SN 17011 it was 95.9%.

Criterion satisfied? yes

## 6.6 Detailed presentation of test results

Table 19: Determination of the availability

|   |   | System 1 (SN 17010) | System 2 (SN 17011) |
|---|---|---------------------|---------------------|
| Operation time<br>( $t_{\text{field}}$ )                            | d | 367                 | 366                 |
| Outage time   | d | 7                   | 3                   |
| Maintenance time incl. zero<br>filter<br>( $t_{\text{cal,maint}}$ ) | d | 12                  | 12                  |
| Actual operating time ( $t_{\text{valid}}$ )                        | d | 348                 | 351                 |
| Availability  | % | 94.8                | 95.9                |

## 6.1 Method used for equivalence testing (7.5.8.4 & 7.5.8.8)

The January 2010 Guide [4] requires compliance with the following five criteria in order to recognise equivalence:

1. Of the full data set, at least 20% of the concentration values (determined with the reference method) shall be greater than the upper assessment threshold specified in 2008/50/EC [7], i.e. 28 µg/m<sup>3</sup> for PM<sub>10</sub> and 17 µg/m<sup>3</sup> for PM<sub>2.5</sub>. Should this not be assured because of low concentration levels, a minimum of 32 value pairs is considered sufficient.
2. Between-AMS uncertainty shall remain below 2.5 µg/m<sup>3</sup> for the overall data and for data sets with data larger than/equal to 30 µg/m<sup>3</sup> PM<sub>10</sub> and 18 µg/m<sup>3</sup> PM<sub>2.5</sub>.
3. The uncertainty between reference systems shall not exceed 2.0 µg/m<sup>3</sup>.
4. The expanded uncertainty ( $W_{CM}$ ) is calculated at 50 µg/m<sup>3</sup> for PM<sub>10</sub> and at 30 µg/m<sup>3</sup> for PM<sub>2.5</sub> for every individual test specimen and checked against the average of the reference method. For each of the following cases, the expanded uncertainty shall not exceed 25%:
  - Full data set:
  - datasets representing PM concentrations greater than/equal to 30 µg/m<sup>3</sup> for PM<sub>10</sub>, or concentrations greater than/equal to 18 µg/m<sup>3</sup> for PM<sub>2.5</sub>, provided that the set contains 40 or more valid data pairs
  - Datasets for each individual site
5. Preconditions for acceptance of the full dataset are that the slope  $b$  is insignificantly different from  $|b-1| \leq 2 \cdot u(b)$  and the intercept  $a$  is insignificantly different from 0:  $|a| \leq 2 \cdot u(a)$ . If these preconditions are not met, the candidate method may be calibrated using the values obtained for slope and/or intercept.

The following chapter address the issue of verifying compliance with the five criteria.

Chapter 6.1 16 Between-AMS uncertainty  $u_{bs,AMS}$  (7.5.8.4) addresses verification of criteria 1 and 2.

Verification of criteria 3, 4 and 5 is reported on in chapter 6.1 17 Expanded uncertainty of AMS results (7.5.8.5–7.5.8.8)

Chapter 6.1 17 Use of correction factors/terms (7.5.8.5–7.5.8.8) contains an assessment for the case that criterion 5 is not complied with without applying correction factors.

## 6.1 16 Between-AMS uncertainty $u_{bs,AMS}$ (7.5.8.4)

*The between-AMS uncertainty  $u_{bs}$  shall be  $\leq 2.5 \mu\text{g}/\text{m}^3$ .*

## 6.2 Equipment

Not required for this performance criterion.

## 6.3 Testing

The test was performed as part of the field test with four separate comparison campaigns. Different seasons as well as different concentrations of PM<sub>2.5</sub> were taken into consideration.

In the full dataset, at least 20% of the results obtained using the reference method should be greater than the upper assessment threshold of the annual limit value specified in 2008/50/EC [7]. The assessment threshold for PM<sub>2.5</sub> is  $17 \mu\text{g}/\text{m}^3$ .

For each comparison campaign, at least 40 valid value pairs were determined. Of the full dataset, (4 locations, 251 valid pairs of measured values for SN 17010, 253 valid pairs for SN 17011) a total of 33.1% of the measured values exceed the upper assessment threshold of  $17 \mu\text{g}/\text{m}^3$  for PM<sub>2.5</sub>. The concentrations measured were related to the ambient conditions.

## 6.4 Evaluation

Chapter 7.5.8.4 of standard EN 16450 specifies that:

The between-AMS uncertainty  $u_{bs}$  shall be  $\leq 2.5 \mu\text{g}/\text{m}^3$ . A between-AMS uncertainty  $> 2.5 \mu\text{g}/\text{m}^3$  is an indication of unsuitable performance of one or both instruments, and equivalence should not be stated.

Uncertainty is determined for:

- All locations or comparisons together (full data set)
- 1 data set with measured values  $\geq 18 \mu\text{g}/\text{m}^3$  for PM<sub>2.5</sub> (basis: averages reference measurement)

Furthermore, this report also covers an evaluation of the following data sets:

- Every location or comparison separately
- 1 data set with measured values  $< 18 \mu\text{g}/\text{m}^3$  for PM<sub>2.5</sub> (basis: averages reference measurement)

The between-AMS uncertainty  $u_{bs}$  is calculated from the differences of all daily averages (24h-values) of the AMS which are operated simultaneously as:

$$u_{bs,AMS}^2 = \frac{\sum_{i=1}^n (y_{i,1} - y_{i,2})^2}{2n}$$

Where:  $y_{i,1}$  and  $y_{i,2}$  = Results of the parallel measurements of individual 24h-values  $i$   
 $n$  = Number of 24h-values

## 6.5 Assessment

At no more than 1.57  $\mu\text{g}/\text{m}^3$  for PM<sub>2,5</sub>, the between-AMS uncertainty  $u_{bs}$  remains well below the permissible maximum of 2.5  $\mu\text{g}/\text{m}^3$ .

Criterion satisfied? yes

## 6.6 Detailed presentation of test results

Table 20 lists the calculated values for the between-AMS uncertainties  $u_{bs}$ . A corresponding chart is provided in Figure 32 to Figure 38.

Table 20: In-between-instrument uncertainty  $u_{bs}$  for the instruments SN 17010 and S/N 17011, measured component PM<sub>2,5</sub>

| Tested instruments             | Location  | Number of measurements | Uncertainty $u_{bs}$     |
|--------------------------------|---|------------------------|--------------------------|
| SN                             |   |                        | $\mu\text{g}/\text{m}^3$ |
| <b>17010 / 17011</b>           | <b>All locations</b>                                      | <b>345</b>             | <b>1.38</b>              |
| Individual locations           |   |                        |                          |
| 17010 / 17011                  | Teddington, Summer  | 97                     | 1.13                     |
| 17010 / 17011                  | Cologne, Winter   | 127                    | 1.76                     |
| 17010 / 17011                  | Bornheim, Summer  | 66                     | 1.13                     |
| 17010 / 17011                  | Teddington, Winter  | 55                     | 1.01                     |
| Classing over reference values |   |                        |                          |
| <b>17010 / 17011</b>           | <b>Values <math>\geq 18 \mu\text{g}/\text{m}^3</math></b> | <b>174</b>             | <b>1.57</b>              |
| 17010 / 17011                  | Values $< 18 \mu\text{g}/\text{m}^3$                      | 74                     | 1.05                     |

Addendum to the report on performance testing, report no. 936/21209919/A of 26 March 2010 for the BAM-1020 with PM<sub>2,5</sub> pre-separator for suspended particulate matter PM<sub>2,5</sub> manufactured by Met One Instruments, Inc., Report No. 936/21243375/A

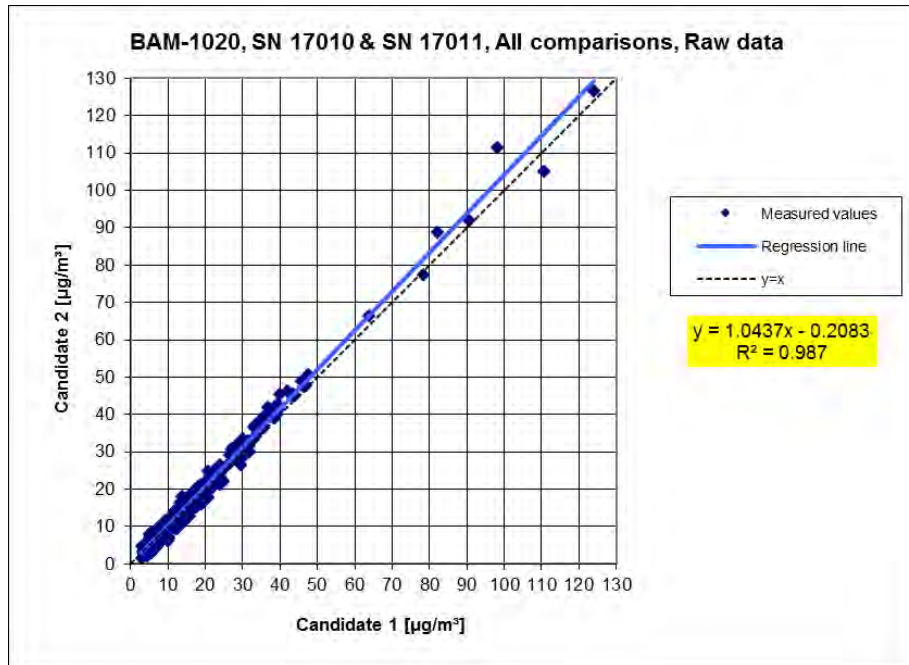

Figure 32: Results of the parallel measurements for instruments SN 17010 / SN 17011, Measured component PM<sub>2.5</sub>, all locations

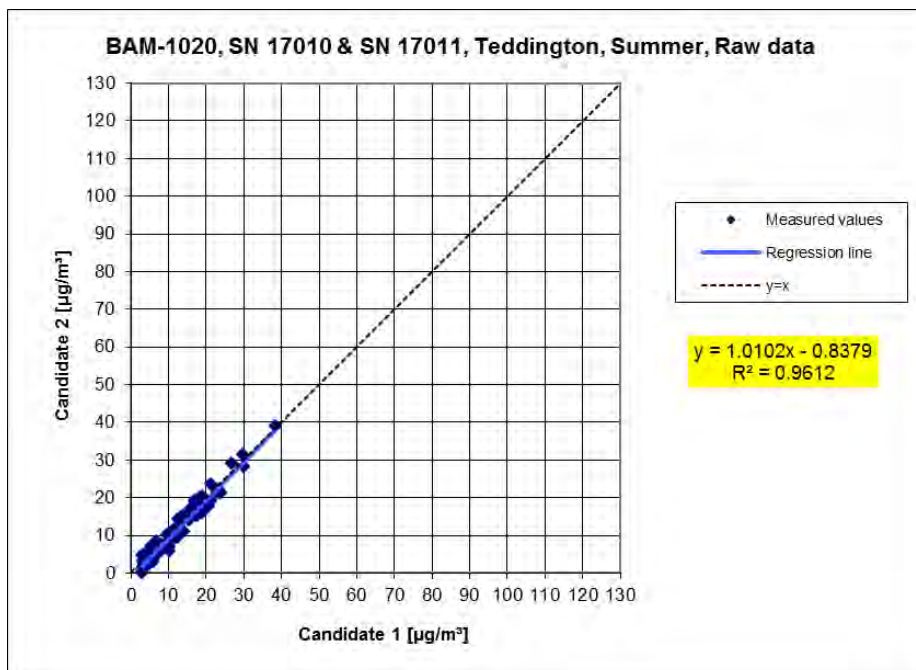

Figure 33: Results of the parallel measurements for instruments SN 17010 / SN 17011, Measured component PM<sub>2.5</sub>, Teddington, summer



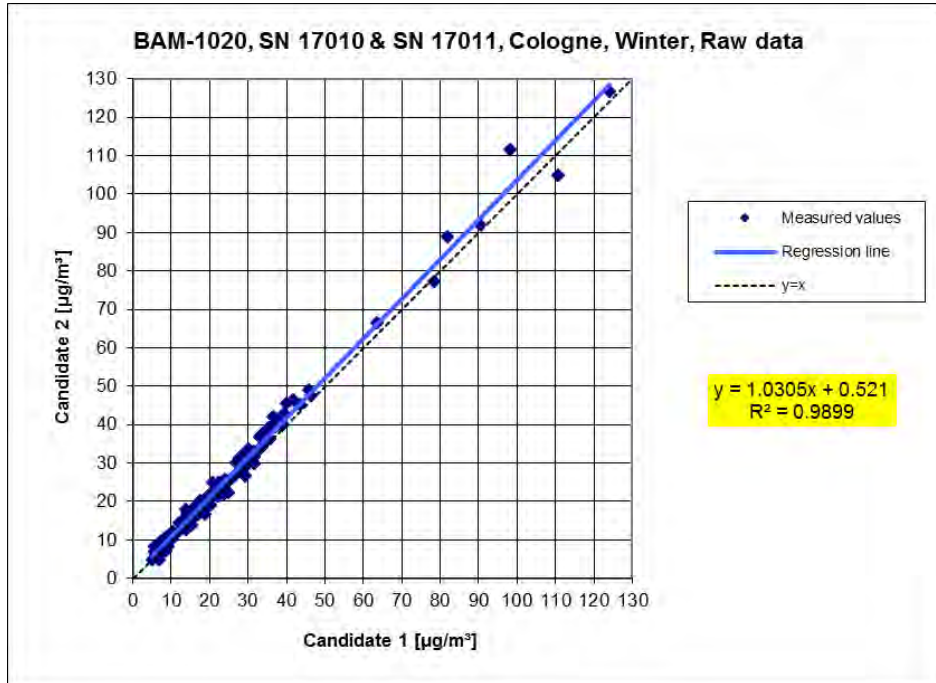

Figure 34: Results of the parallel measurements for instruments SN 17010 / SN 17011, Measured component PM<sub>2,5</sub>, location: Cologne, Winter

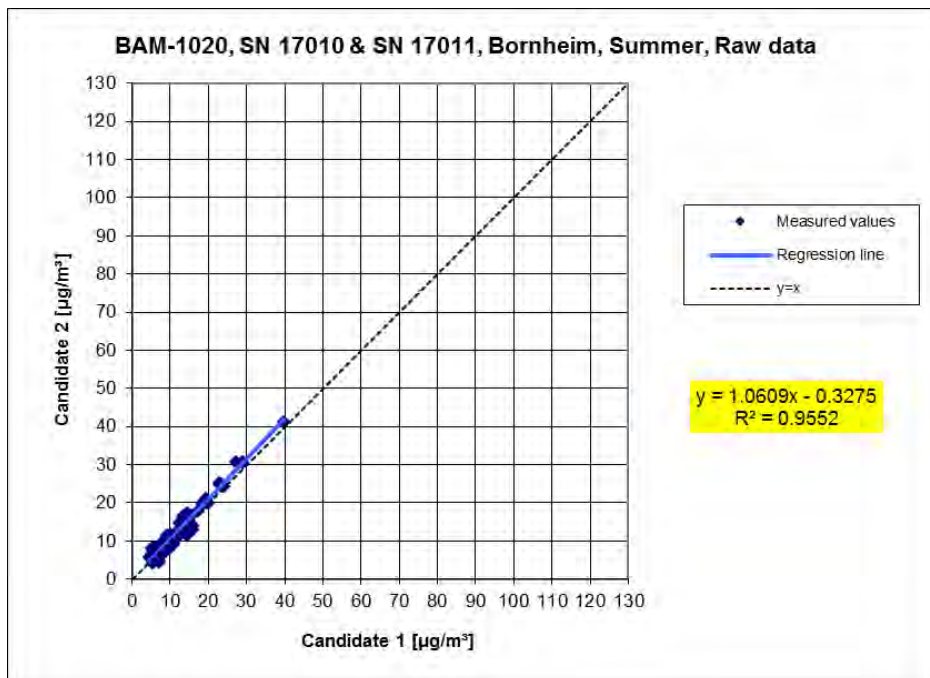

Figure 35: Results of the parallel measurements for instruments SN 17010 / SN 17011, Measured component PM<sub>2,5</sub>, location: Bornheim, Summer

Addendum to the report on performance testing, report no. 936/21209919/A of 26 March 2010 for the BAM-1020 with PM<sub>2,5</sub> pre-separator for suspended particulate matter PM<sub>2,5</sub> manufactured by Met One Instruments, Inc., Report No. 936/21243375/A

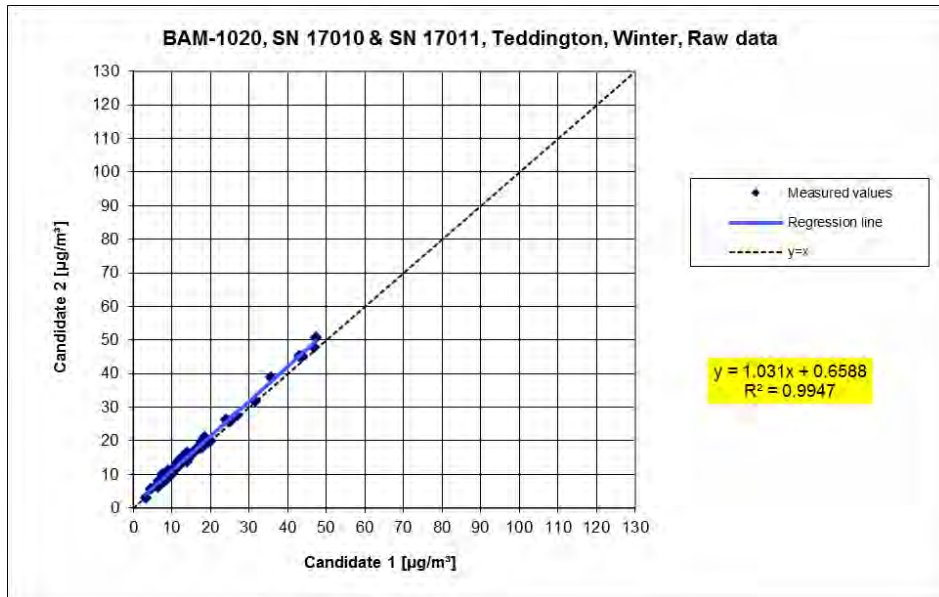

Figure 36: Results of the parallel measurements for instruments SN 17010 / SN 17011, Measured component PM<sub>2.5</sub>, Teddington, winter

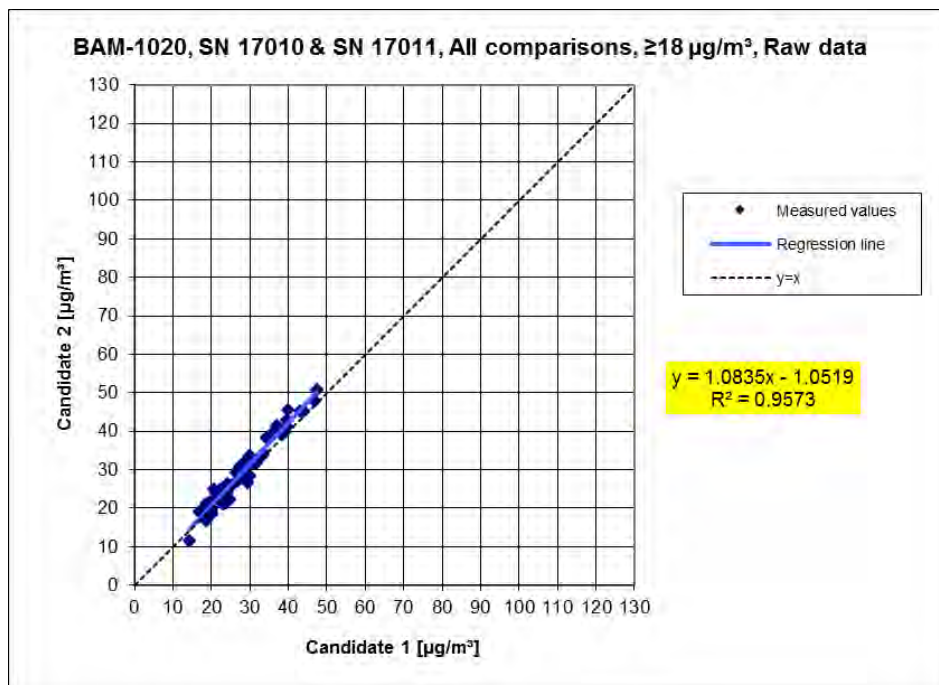

Figure 37: Results of the parallel measurements for instruments SN 17010 / SN 17011, Measured component PM<sub>2.5</sub>, all locations, values ≥ 18 µg/m<sup>3</sup>

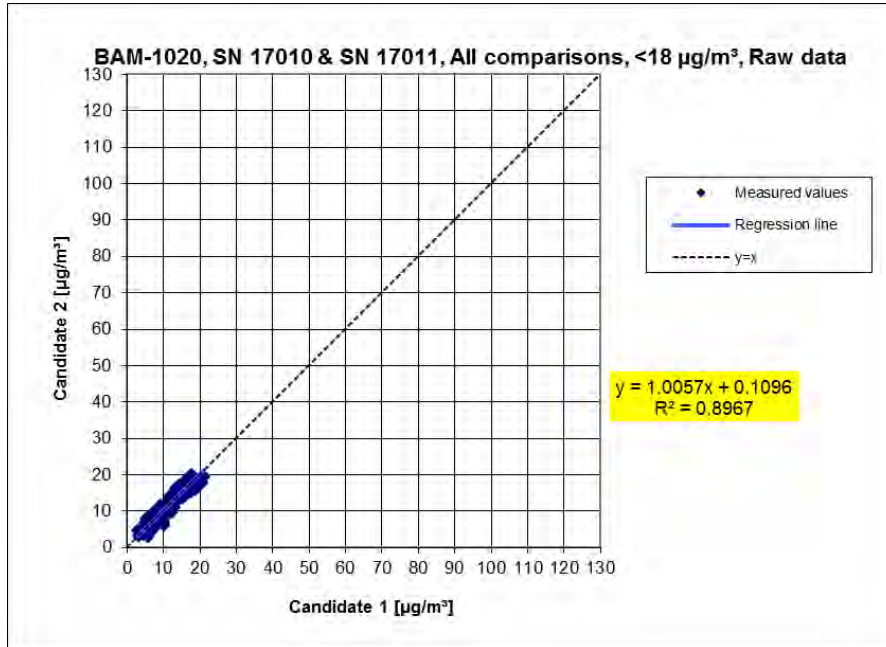

Figure 38: Results of the parallel measurements for instruments SN 17010 / SN 17011, Measured component PM<sub>2.5</sub>, all locations, values < 18 µg/m<sup>3</sup>

## 6.1 17 Expanded uncertainty of AMS results (7.5.8.5–7.5.8.8)

*The expanded uncertainty shall be  $\leq 25\%$  at the level of the relevant limit value related to the 24-hour average results – after a calibration where necessary.*

## 6.2 Equipment

Additional equipment as described in chapter 5 of this report was used for this test.

## 6.3 Testing

The test was performed as part of the field test with four separate comparison campaigns. Different seasons as well as different concentrations of PM<sub>2.5</sub> were taken into consideration.

In the full dataset, at least 20% of the results obtained using the reference method should be greater than the upper assessment threshold of the annual limit value specified in 2008/50/EC [7]. The assessment threshold for PM<sub>2.5</sub> is 17  $\mu\text{g}/\text{m}^3$ .

For each comparison campaign, at least 40 valid value pairs were determined. Of the full dataset, (4 locations, 251 valid pairs of measured values for SN 17010, 253 valid pairs for SN 17011) a total of 33.1% of the measured values exceed the upper assessment threshold of 17  $\mu\text{g}/\text{m}^3$  for PM<sub>2.5</sub>. The concentrations measured were related to the ambient conditions.

## 6.4 Evaluation

[EN 16450, 7.5.8.3]

Before calculating the expanded uncertainty of the test specimens, uncertainties were established between the simultaneously operated reference measuring systems ( $u_{\text{ref}}$ )

Uncertainties between the simultaneously operated reference measuring systems  $u_{\text{bs, RM}}$  were established similar to the between-AMS uncertainties and shall be  $\leq 2.0 \mu\text{g}/\text{m}^3$ .

Results of the evaluation are summarised in section 6.6.

[EN 16450, 7.5.8.5 & 7.5.8.6]

In order to assess comparability of the tested instruments  $y$  with the reference method  $x$ , a linear relationship  $y_i = a + bx_i$  between the measured values of both methods is assumed. The association between the means of the reference systems and each individual test specimen to be assessed is established by means of orthogonal regression.

The regression is calculated for:

- all sites or comparisons respectively together
- Every location or comparison separately
- 1 data set with measured values  $PM_{2,5} \geq 18 \mu\text{g}/\text{m}^3$  (basis: averages of reference measurement)

For further assessment, the uncertainty  $u_{c,s}$  resulting from a comparison of the test specimens with the reference method is described in the following equation which defines  $u_{CR}$  as a function of the fine dust concentration  $x_i$ .

$$u_{yi}^2 = \frac{RSS}{(n-2)} - u_{RM}^2 + [a + (b-1)L]^2$$

Where RSS is the sum of the (relative) residuals from orthogonal regression

$u_{RM}$  = is the random uncertainty of the reference method;  $u_{RM}$  is calculated as  $u_{bs,RM}/\sqrt{2}$ , with  $u_{bs,RM}$  as the between-RM uncertainty.

The algorithms for calculating axis intercept a and slope b as well as their variance by means of orthogonal regression are described in detail in the annex to [8].

The sum of (relative) residuals RSS is calculated according to the following equation:

$$RSS = \sum_{i=1}^n (y_i - a - bx_i)^2$$

Uncertainty  $u_{CR}$  is calculated for:

- all sites or comparisons respectively together
- Every location or comparison separately
- 1 data set with measured values  $PM_{2,5} \geq 18 \mu\text{g}/\text{m}^3$  (basis: averages of reference measurement)

The Guideline states the following prerequisite for accepting the full data set:

- The slope be is insignificantly different from 1:  $|b-1| \leq 2 \cdot u(b)$
- and
- The axis intercept a is insignificantly different from 0:  $|a| \leq 2 \cdot u(a)$ ,

where  $u(a)$  and  $u(b)$  describe the standard uncertainty of the slope and the axis intercept calculated as the square root of the variance. If the prerequisites are not met, it is possible to calibrate the measuring systems in accordance with section 9.7 of the Guideline (also see 6.1 17 Use of correction factors/terms ). The calibration may only be performed for the full data set.

[EN 16450, 7.5.8.7] For all datasets the combined relative uncertainty of the AMS  $w_{c,CM}$  is calculated from a combination of contributions from 9.5.3.1 and 9.5.3.2 in accordance with the following equation:

$$w_{AMS}^2 = \frac{u_{yi=L}^2}{L^2}$$

For each data set the uncertainty  $w_{AMS}$  is calculated at a level of  $L = 30 \mu\text{g}/\text{m}^3$  for PM<sub>2.5</sub>.

[EN 16450 7.5.8.8] For each data set the expanded relative uncertainty of the results measured with the test specimen is calculated by multiplying  $w_{AMS}$  by an coverage factor  $k$  according to the following equation:

$$W_{AMS} = k \cdot w_{AMS}$$

In practice,  $k$  is specified at  $k=2$  for large  $n$ .

[Item 9.6]

The largest resulting uncertainty  $W_{AMS}$  is compared and assessed against the criteria for data quality of air quality measurements in accordance with EU Directive [7]. Two situations are conceivable:

1.  $W_{AMS} \leq W_{dqo}$  → The test is deemed equivalent to the reference method.
2.  $W_{AMS} > W_{dqo}$  → The tested instrument is not deemed equivalent to the reference method.

The expanded relative uncertainty  $W_{dqo}$  specified is 25% [7].

## 7.5 Assessment

The uncertainty  $W_{CM}$  determined without applying correction factors for all observed data sets is below the determined expanded relative uncertainty  $W_{dqo}$  of 25% for fine particulate matter.

Criterion satisfied? yes

Given the significance of the axis intercept for the total set of data, a correction factor is applied according to chapter 6.1 17 Use of correction factors/terms. In spite of the significant slope identified for the complete data set, a correction does not appear to make sense as the slope of the complete data set to be used for correction is 1.000.

The following Table 21 shows an overview on all results of the equivalence test for the BAM-1020 for PM<sub>2,5</sub>. Where a criterion was not satisfied, the corresponding line is marked in red.

Table 21: Overview of the equivalence test for the BAM-1020 for PM<sub>2,5</sub>

| Comparison candidate with reference according to<br>Standard EN 16450:2017 |          |                     |                     |                   |
|--|----------|---------------------|---------------------|-------------------|
| Candidate  | BAM-1020 | SN                  | SN 17010 & SN 17011 |                   |
| Status of measured values  | Raw data | Limit value         | 30                  | µg/m <sup>3</sup> |
|  |          | Allowed uncertainty | 25                  | %                 |
| <b>All comparisons</b>   |          |                     |                     |                   |
| Uncertainty between Reference  | 0.33     |                     |                     | µg/m <sup>3</sup> |
| Uncertainty between Candidates   | 1.38     |                     |                     | µg/m <sup>3</sup> |
| <b>SN 17010 &amp; SN 17011</b>   |          |                     |                     |                   |
| Number of data pairs   | 248      |                     |                     |                   |
| Slope b  | 1.000    |                     |                     | not significant   |
| Uncertainty of b   | 0.012    |                     |                     |                   |
| Ordinate intercept a   | 0.764    |                     |                     | significant       |
| Uncertainty of a   | 0.204    |                     |                     |                   |
| Expanded meas. uncertainty W <sub>CM</sub>                                 | 12.70    |                     |                     | %                 |
| <b>All comparisons, ≥18 µg/m<sup>3</sup></b>                               |          |                     |                     |                   |
| Uncertainty between Reference  | 0.30     |                     |                     | µg/m <sup>3</sup> |
| Uncertainty between Candidates   | 1.57     |                     |                     | µg/m <sup>3</sup> |
| <b>SN 17010 &amp; SN 17011</b>   |          |                     |                     |                   |
| Number of data pairs   | 74       |                     |                     |                   |
| Slope b  | 1.031    |                     |                     |                   |
| Uncertainty of b   | 0.033    |                     |                     |                   |
| Ordinate intercept a   | -0.068   |                     |                     |                   |
| Uncertainty of a   | 0.919    |                     |                     |                   |
| Expanded meas. uncertainty W <sub>CM</sub>                                 | 15.96    |                     |                     | %                 |
| <b>All comparisons, &lt;18 µg/m<sup>3</sup></b>                            |          |                     |                     |                   |
| Uncertainty between Reference  | 0.34     |                     |                     | µg/m <sup>3</sup> |
| Uncertainty between Candidates   | 1.05     |                     |                     | µg/m <sup>3</sup> |
| <b>SN 17010 &amp; SN 17011</b>   |          |                     |                     |                   |
| Number of data pairs   | 174      |                     |                     |                   |
| Slope b  | 0.971    |                     |                     |                   |
| Uncertainty of b   | 0.025    |                     |                     |                   |
| Ordinate intercept a   | 1.066    |                     |                     |                   |
| Uncertainty of a   | 0.267    |                     |                     |                   |
| Expanded meas. uncertainty W <sub>CM</sub>                                 | 9.93     |                     |                     | %                 |



Addendum to the report on performance testing, report no. 936/21209919/A of 26 March 2010 for the BAM-1020 with PM2,5 pre-separator for suspended particulate matter PM2,5 manufactured by Met One Instruments, Inc., Report No. 936/21243375/A

Page 91 of 160

| Comparison candidate with reference according to Standard EN 16450:2017 |          |                     |                     |                 |
|---|----------|---------------------|---------------------|-----------------|
| Candidate   | BAM-1020 | SN                  | SN 17010 & SN 17011 |                 |
| Status of measured values   | Raw data | Limit value         | 30                  | µg/m³           |
|   |          | Allowed uncertainty | 25                  | %               |
| <b>Teddington, Summer</b>   |          |                     |                     |                 |
| Uncertainty between Reference   | 0.33     | µg/m³               |                     |                 |
| Uncertainty between Candidates  | 1.13     | µg/m³               |                     |                 |
|   | SN 17010 |                     | SN 17011            |                 |
| Number of data pairs  | 78       |                     | 78                  |                 |
| Slope b   | 0.994    |                     | 1.016               |                 |
| Uncertainty of b  | 0.030    |                     | 0.025               |                 |
| Ordinate intercept a  | 1.822    |                     | 1.018               |                 |
| Uncertainty of a  | 0.372    |                     | 0.308               |                 |
| Expanded meas. uncertainty W <sub>CM</sub>                              | 17.18    | %                   | 14.74               | %               |
| <b>Cologne, Winter</b>  |          |                     |                     |                 |
| Uncertainty between Reference   | 0.39     | µg/m³               |                     |                 |
| Uncertainty between Candidates  | 1.76     | µg/m³               |                     |                 |
|   | SN 17010 |                     | SN 17011            |                 |
| Number of data pairs  | 75       |                     | 75                  |                 |
| Slope b   | 0.980    |                     | 1.061               |                 |
| Uncertainty of b  | 0.024    |                     | 0.019               |                 |
| Ordinate intercept a  | 0.960    |                     | 0.430               |                 |
| Uncertainty of a  | 0.512    |                     | 0.405               |                 |
| Expanded meas. uncertainty W <sub>CM</sub>                              | 12.92    | %                   | 18.01               | %               |
| <b>Bornheim, Summer</b>   |          |                     |                     |                 |
| Uncertainty between Reference   | 0.30     | µg/m³               |                     |                 |
| Uncertainty between Candidates  | 1.13     | µg/m³               |                     |                 |
|   | SN 17010 |                     | SN 17011            |                 |
| Number of data pairs  | 53       |                     | 57                  |                 |
| Slope b   | 1.052    |                     | 1.134               |                 |
| Uncertainty of b  | 0.036    |                     | 0.048               |                 |
| Ordinate intercept a  | -0.962   |                     | -1.498              |                 |
| Uncertainty of a  | 0.527    |                     | 0.727               |                 |
| Expanded meas. uncertainty W <sub>CM</sub>                              | 11.69    | %                   | 23.95               | %               |
| <b>Teddington, Winter</b>   |          |                     |                     |                 |
| Uncertainty between Reference   | 0.27     | µg/m³               |                     |                 |
| Uncertainty between Candidates  | 1.01     | µg/m³               |                     |                 |
|   | SN 17010 |                     | SN 17011            |                 |
| Number of data pairs  | 45       |                     | 43                  |                 |
| Slope b   | 0.970    |                     | 0.991               |                 |
| Uncertainty of b  | 0.014    |                     | 0.014               |                 |
| Ordinate intercept a  | -0.182   |                     | 0.630               |                 |
| Uncertainty of a  | 0.300    |                     | 0.293               |                 |
| Expanded meas. uncertainty W <sub>CM</sub>                              | 10.35    | %                   | 7.51                | %               |
| <b>All comparisons, ≥18 µg/m³</b>                                       |          |                     |                     |                 |
| Uncertainty between Reference   | 0.30     | µg/m³               |                     |                 |
| Uncertainty between Candidates  | 1.57     | µg/m³               |                     |                 |
|   | SN 17010 |                     | SN 17011            |                 |
| Number of data pairs  | 76       |                     | 75                  |                 |
| Slope b   | 0.984    |                     | 1.092               |                 |
| Uncertainty of b  | 0.035    |                     | 0.034               |                 |
| Ordinate intercept a  | 0.584    |                     | -1.108              |                 |
| Uncertainty of a  | 0.975    |                     | 0.95                |                 |
| Expanded meas. uncertainty W <sub>CM</sub>                              | 16.08    | %                   | 19.09               | %               |
| <b>All comparisons, &lt;18 µg/m³</b>                                    |          |                     |                     |                 |
| Uncertainty between Reference   | 0.34     | µg/m³               |                     |                 |
| Uncertainty between Candidates  | 1.05     | µg/m³               |                     |                 |
|   | SN 17010 |                     | SN 17011            |                 |
| Number of data pairs  | 175      |                     | 178                 |                 |
| Slope b   | 0.955    |                     | 1.021               |                 |
| Uncertainty of b  | 0.028    |                     | 0.026               |                 |
| Ordinate intercept a  | 1.137    |                     | 0.634               |                 |
| Uncertainty of a  | 0.306    |                     | 0.286               |                 |
| Expanded meas. uncertainty W <sub>CM</sub>                              | 11.57    | %                   | 13.54               | %               |
| <b>All comparisons</b>  |          |                     |                     |                 |
| Uncertainty between Reference   | 0.33     | µg/m³               |                     |                 |
| Uncertainty between Candidates  | 1.38     | µg/m³               |                     |                 |
|   | SN 17010 |                     | SN 17011            |                 |
| Number of data pairs  | 251      |                     | 253                 |                 |
| Slope b   | 0.969    | significant         | 1.041               | significant     |
| Uncertainty of b  | 0.013    |                     | 0.012               |                 |
| Ordinate intercept a  | 0.989    | significant         | 0.377               | not significant |
| Uncertainty of a  | 0.226    |                     | 0.214               |                 |
| Expanded meas. uncertainty W <sub>CM</sub>                              | 12.99    | %                   | 16.35               | %               |



Results for testing the five criteria from chapter 6.1 Method used for equivalence testing were as follows:

- Criterion 1: More than 20% of the data exceed 17 µg/m<sup>3</sup>.
- Criterion 2: Between-AMS uncertainty of the AMS tested did not exceed 2.5 µg/m<sup>3</sup>.
- Criterion 3: Uncertainty between reference instruments did not exceed 2.0 µg/m<sup>3</sup>.
- Criterion 4: All expanded uncertainties remained below 25%.
- Criterion 5) The intercept and slope of the 'All Data' comparison for S/N 17010 are significant. The slope of the 'All Data' comparison for S/N 17011 is significant.

The evaluation of the full data set for both test specimen shows that the measuring system provides good correlation with the reference method: the slope is 1.000 and the intercept is 0.764 at an expanded total uncertainty of 12.70%.

The January 2010 version of the Guideline does not specify clearly which axis intercept and which slope to use for correcting test specimens if a test specimen does not meet the requirements for equivalence testing. After double-checking with the chair of the EU working group responsible for issuing the Guideline (Mr Theo Hafkenscheid), we decided to apply the requirements of the November 2005 version of the Guideline and to use the slope and the intercept determined by means of orthogonal regression for the full data set. These are listed for each criterion under "Additional"

As a result of the significance determined for PM<sub>2,5</sub>, the axis intercept has to be corrected according to Table 21. In spite of the significant slope identified for the complete data set, a correction does not appear to make sense as the slope of the complete data set to be used for correction is 1.000.

It should be noted here that the uncertainty  $W_{CM}$  determined without applying correction factors for all observed data sets is below the determined expanded relative uncertainty  $W_{dqo}$  of 25% for PM<sub>2.5</sub>.

For compliant monitoring, the revised version of the January 2010 Guideline and standard EN 16450 require continuous random checks of a certain number of instruments in a measurement grid and specify the number of measurement sites to be checked as a function of the expanded uncertainty of a measuring system. The operator of the measurement grid or the competent authority of a member state is responsible for compliant implementation. However, TÜV Rheinland recommends that the expanded uncertainty of the entire data set (in the present case, the uncorrected raw data) be used for this purpose: 12.7% for PM<sub>2.5</sub>, implying annual checks at three measurement sites (Guideline [4], Chapter 9.9.2, Table 6 or EN 16450 [8], Chapter 8.6.2, Table 5). As a result of the necessary use of calibration factors, this assessment should be based on the evaluation of the corrected data sets (see chapter 6.1 17 Use of correction factors/terms ).

Addendum to the report on performance testing, report no. 936/21209919/A of 26 March 2010 for the BAM-1020 with PM<sub>2,5</sub> pre-separator for suspended particulate matter PM<sub>2,5</sub> manufactured by Met One Instruments, Inc., Report No. 936/21243375/A

## 6.6 Detailed presentation of test results

Table 22 provides an overview of the between-RM uncertainties  $u_{bs, RM}$  determined during the field tests.

Table 22: Between RM uncertainty  $u_{bs, RM}$  for PM<sub>2.5</sub>

| Reference instruments | Location           | Number of measurements | Uncertainty $u_{bs, RM}$ |
|-----------------------|--------------------|------------------------|--------------------------|
| No.                   |                    |                        | $\mu\text{g}/\text{m}^3$ |
| 1 / 2                 | Teddington, Summer | 77                     | 0.33                     |
| 1 / 2                 | Cologne, Winter    | 75                     | 0.39                     |
| 1 / 2                 | Bornheim, Summer   | 53                     | 0.30                     |
| 1 / 2                 | Teddington, Winter | 43                     | 0.27                     |
| 1 / 2                 | All locations      | 248                    | 0.33                     |

At all sites, between-RM uncertainty  $u_{bs, RM}$  was  $< 2.0 \mu\text{g}/\text{m}^3$ .

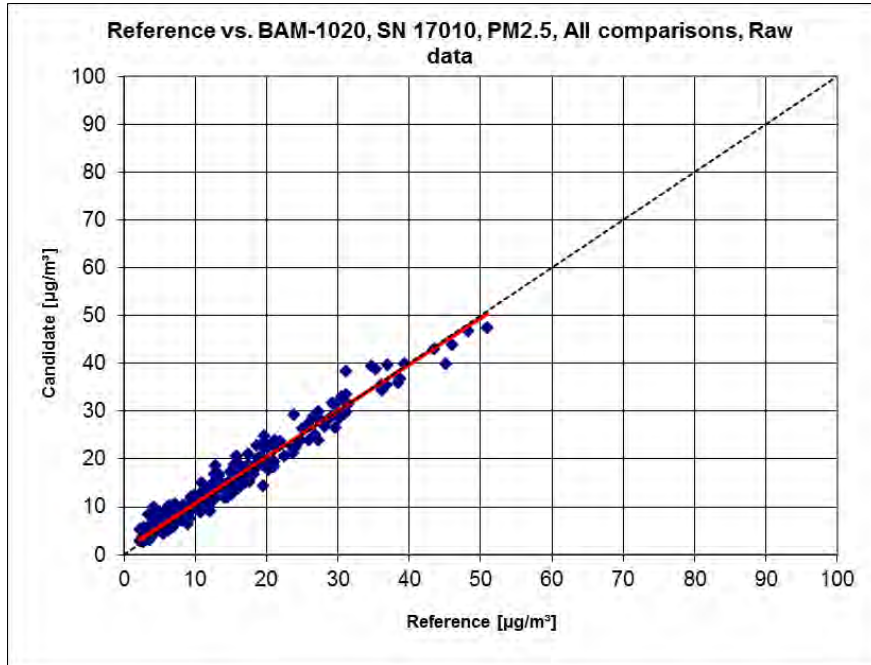

Figure 39: Reference vs. tested instrument, SN 17010, component PM<sub>2,5</sub>, all sites

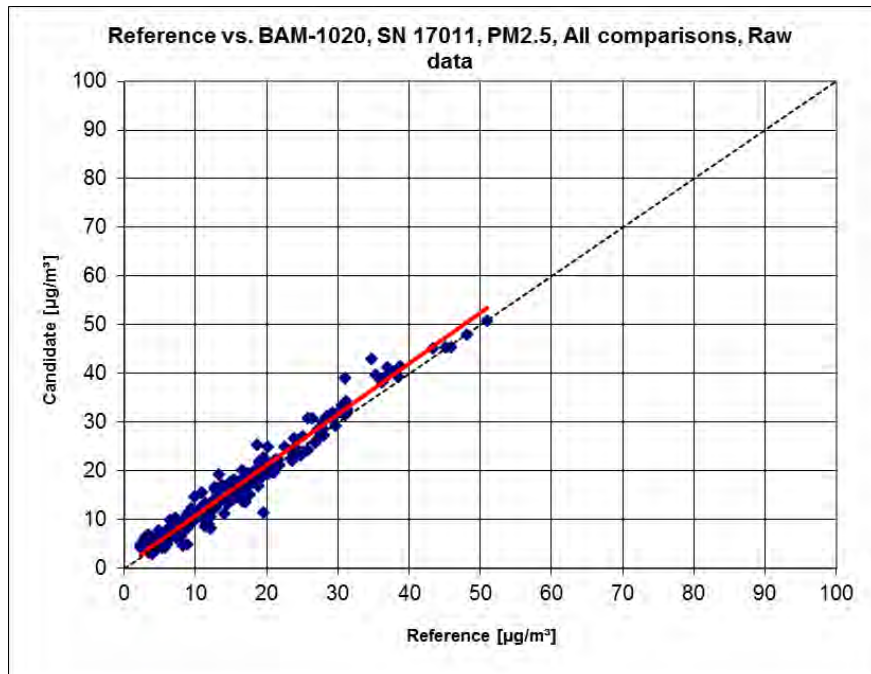

Figure 40: Reference vs. tested instrument, SN 17011, component PM<sub>2,5</sub>, all sites

Addendum to the report on performance testing, report no. 936/21209919/A of 26 March 2010 for the BAM-1020 with PM<sub>2,5</sub> pre-separator for suspended particulate matter PM<sub>2,5</sub> manufactured by Met One Instruments, Inc., Report No. 936/21243375/A

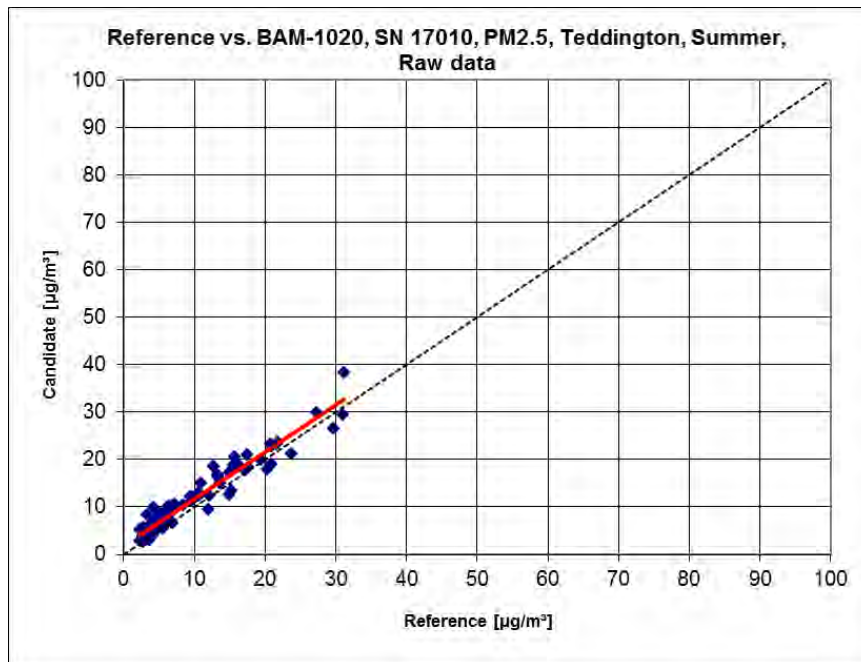

Figure 41: Reference vs. tested instrument, SN 17010, component PM<sub>2,5</sub>, Teddington, summer

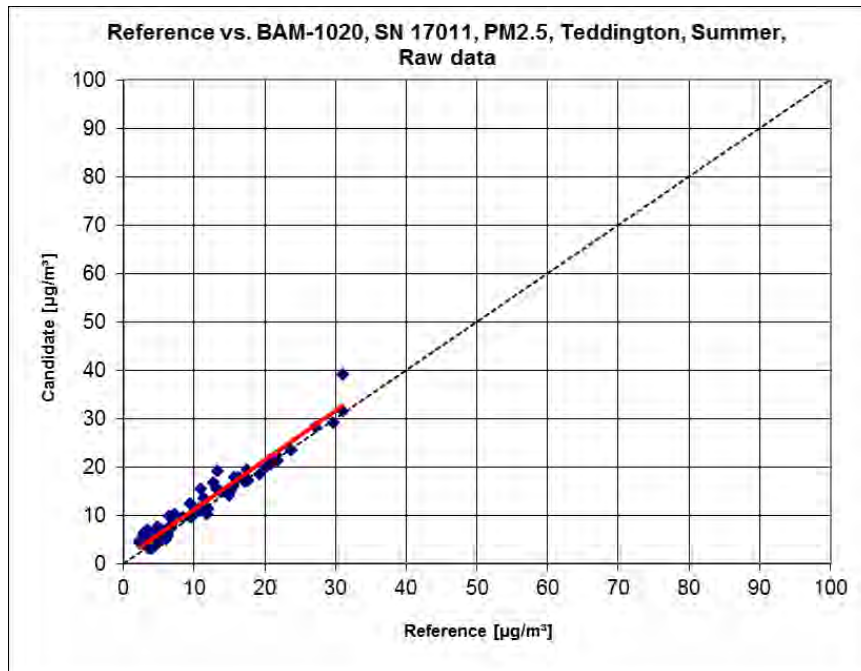

Figure 42: Reference vs. tested instrument, SN 17011, component PM<sub>2,5</sub>, Teddington, summer

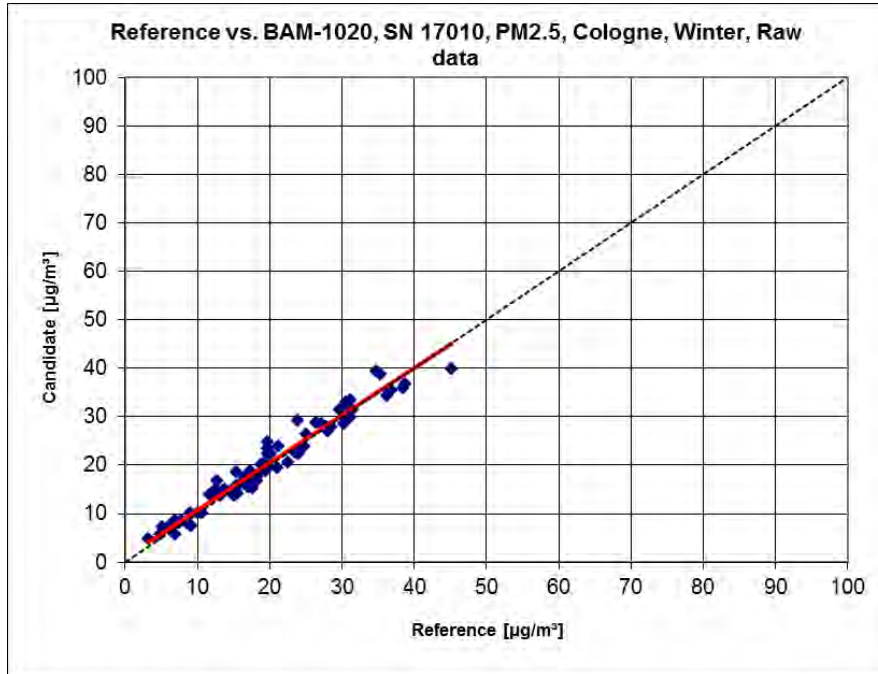

Figure 43: Reference vs. tested instrument, SN 17010, component PM<sub>2,5</sub>, Cologne, winter

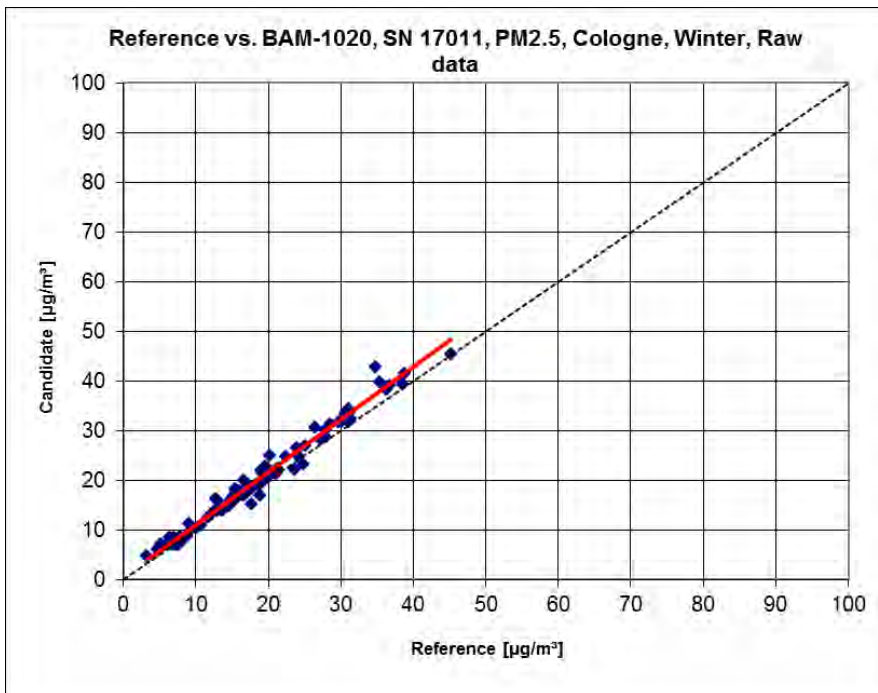

Figure 44: Reference vs. tested instrument, SN 17011, component PM<sub>2,5</sub>, Cologne, winter

Addendum to the report on performance testing, report no. 936/21209919/A of 26 March 2010 for the BAM-1020 with PM<sub>2,5</sub> pre-separator for suspended particulate matter PM<sub>2,5</sub> manufactured by Met One Instruments, Inc., Report No. 936/21243375/A

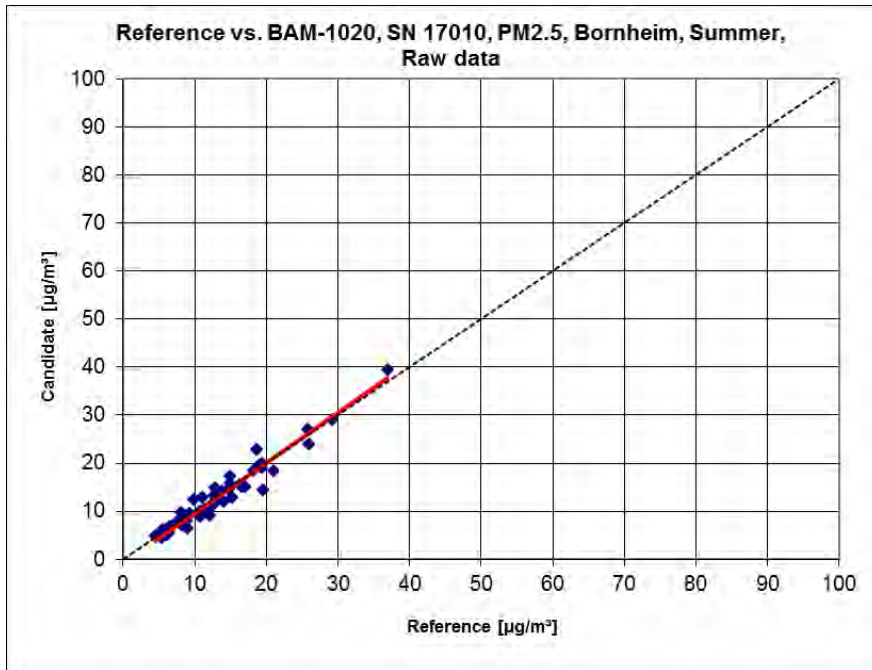

Figure 45: Reference vs. tested instrument, SN 17010, component PM<sub>2,5</sub>, Bornheim, summer,

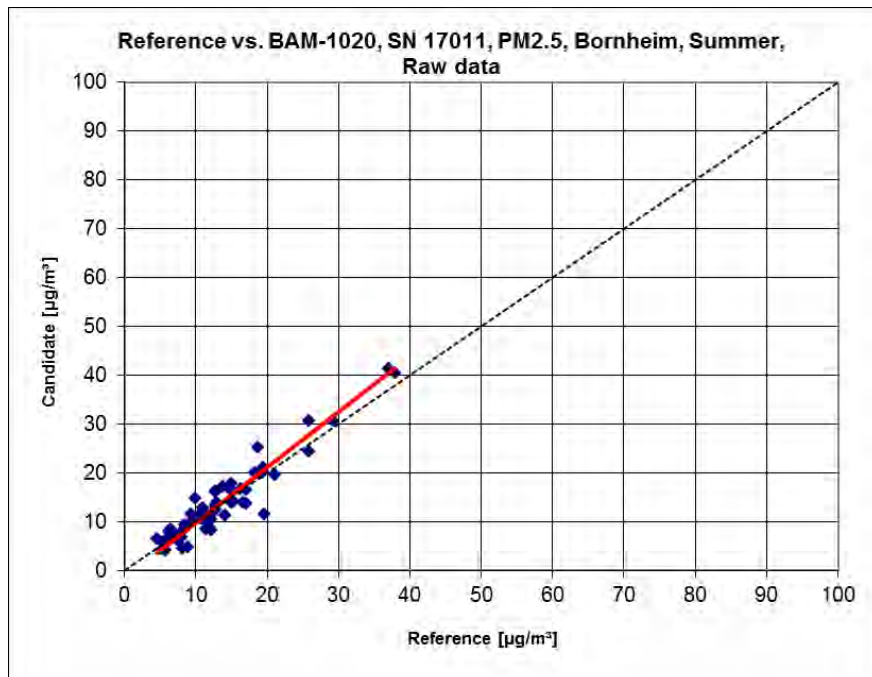

Figure 46: Reference vs. tested instrument, SN 17011, component PM<sub>2,5</sub>, Bornheim, summer,



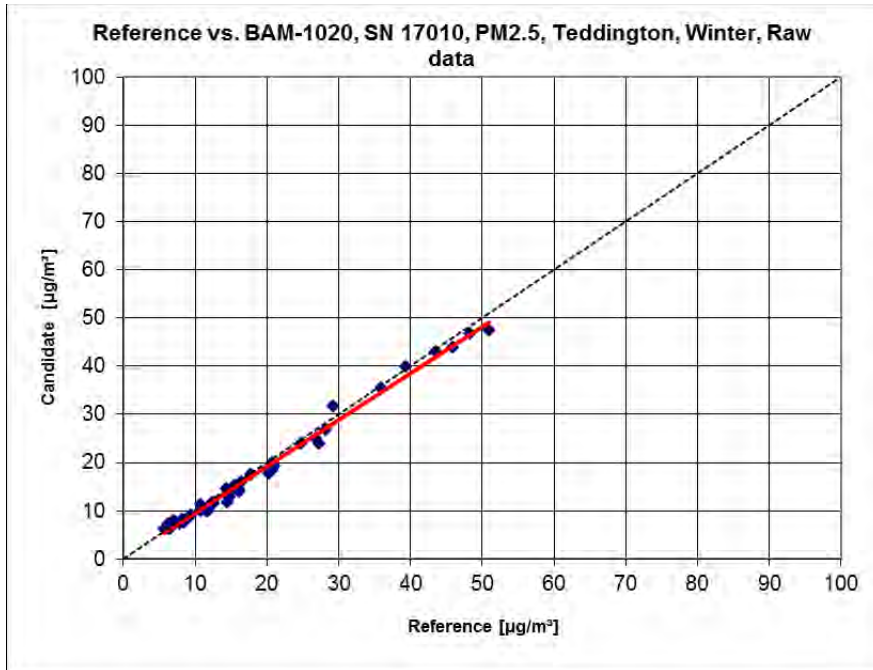

Figure 47: Reference vs. tested instrument, SN 17010, component PM<sub>2,5</sub>, Teddington, winter

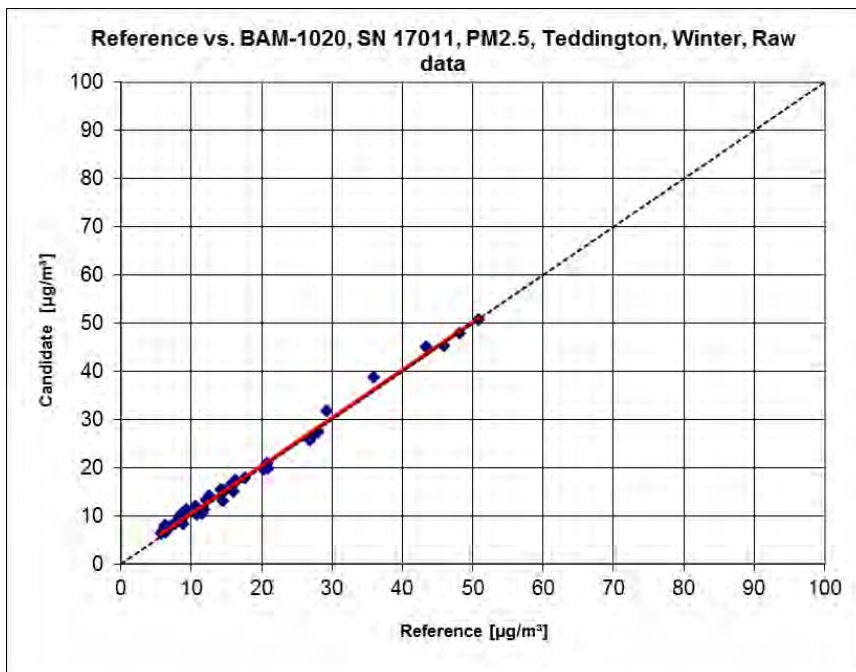

Figure 48: Reference vs. tested instrument, SN 17011, component PM<sub>2,5</sub>, Teddington, winter

Addendum to the report on performance testing, report no. 936/21209919/A of 26 March 2010 for the BAM-1020 with PM<sub>2,5</sub> pre-separator for suspended particulate matter PM<sub>2,5</sub> manufactured by Met One Instruments, Inc., Report No. 936/21243375/A

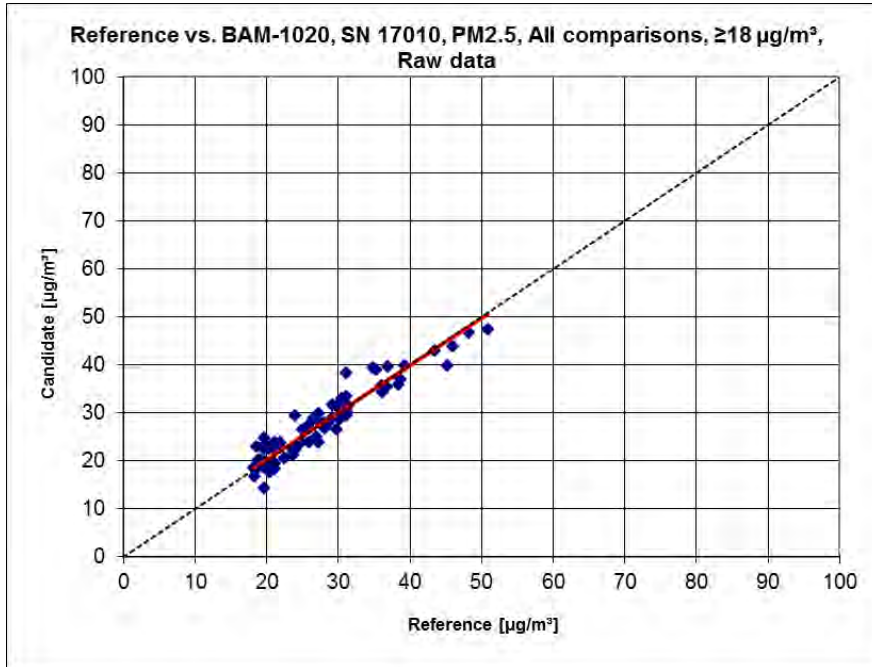

Figure 49: Reference vs. tested instrument, SN 17010, component PM<sub>2,5</sub>, values  $\geq 18 \mu\text{g}/\text{m}^3$

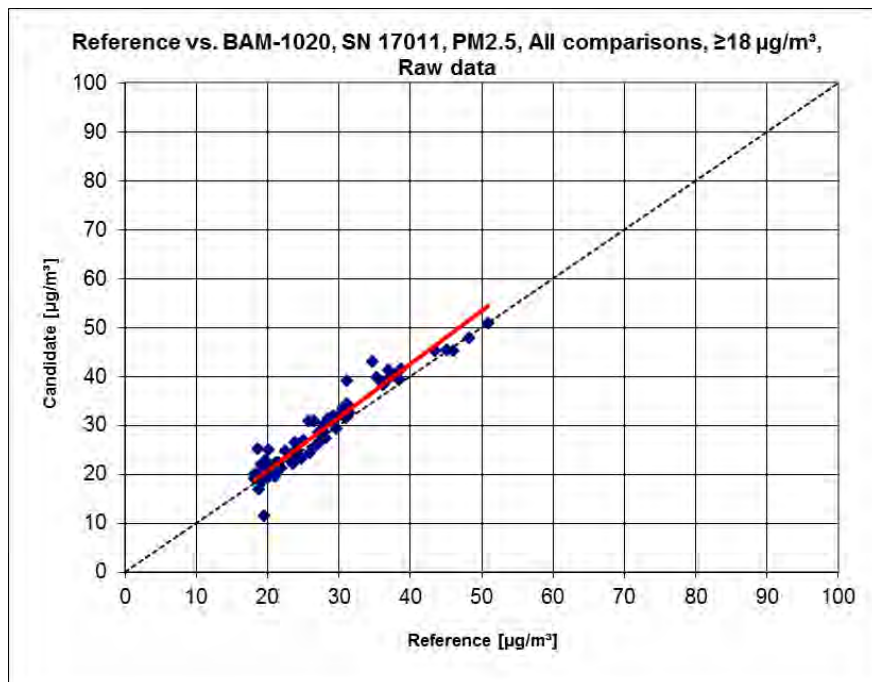

Figure 50: Reference vs. tested instrument, SN 17011, component PM<sub>2,5</sub>, values  $\geq 18 \mu\text{g}/\text{m}^3$



## 6.1 17 Use of correction factors/terms (7.5.8.5–7.5.8.8)

*Correction factors/terms (=calibration) shall be applied in the event the highest expanded uncertainty calculated for the tested instruments exceeds the relative expanded uncertainty specified under requirements for data quality or the test demonstrates that the slope is significantly different from 1 and/or the ordinate intercept is significantly different from 0.*

## 6.2 Equipment

Not required for this performance criterion.

## 6.3 Testing

See item 6.1 17 Expanded uncertainty of AMS results (7.5.8.5–7.5.8.8)

## 6.4 Evaluation

If it emerges from the evaluation of raw data in accordance with 6.1 17 Expanded uncertainty of AMS results (7.5.8.5–7.5.8.8) that  $W_{AMS} > W_{dqo}$ , i.e. the tested instrument is not found to be equivalent with the reference method, then it is permissible to use a correction factor or term which results from the regression equation for the full data set. The corrected values have to meet the requirements for all data sets or sub data sets. Moreover, a correction may also be used for the case that  $W_{AMS} \leq W_{dqo}$  in order to improve the accuracy of the tested instruments.

Three different situations may occur:

a) Slope  $b$  is not significantly different from 1:  $|b - 1| \leq 2u(b)$

Axis intercept  $a$  is significantly different from 0:  $|a| > 2u(a)$

b) Slope  $b$  is significantly different from 1:  $|b - 1| > 2u(b)$

axis intercept  $a$  is not significantly different from 0:  $|a| \leq 2u(a)$

b) Slope  $b$  is significantly different from 1:  $|b - 1| > 2u(b)$

Axis intercept  $a$  is significantly different from 0:  $|a| > 2u(a)$

concerning  $a$ )

The value of the axis intercept  $a$  may be used as a correction term to correct all input values  $y_i$  according to the following equation:

$$y_{i,cor} = y_i - a$$

Addendum to the report on performance testing, report no. 936/21209919/A of 26 March 2010 for the BAM-1020 with PM<sub>2,5</sub> pre-separator for suspended particulate matter PM<sub>2,5</sub> manufactured by Met One Instruments, Inc., Report No. 936/21243375/A

Page 101 of 160

The corrected values  $y_{i,corr}$  may then serve to calculate the following new terms using linear regression:

$$y_{i,corr} = c + dx_i$$

and

$$u_{y_{i,corr}}^2 = \frac{RSS}{(n-2)} - u_{RM}^2 + [c + (d-1)L]^2 + u^2(a)$$

where  $u(a)$  = uncertainty of the axis intercept  $a$ , whose value was used to determine  $y_{i,corr}$ .

The algorithms for calculating axis intercepts and slopes as well as their variance by means of orthogonal regression are described in detail in the annex to [8].

concerning b)

The value of the slope  $b$  may be used as a correction term to correct all input values  $y_i$  according to the following equation:

$$y_{i,corr} = \frac{y_i}{b}$$

The corrected values  $y_{i,corr}$  may then serve to calculate the following new terms using a new linear regression:

$$y_{i,corr} = c + dx_i$$

and

$$u_{y_{i,corr}}^2 = \frac{RSS}{(n-2)} - u_{RM}^2 + [c + (d-1)L]^2 + L^2 u^2(b)$$

where  $u(b)$  = uncertainty of the original slope  $b$ , whose value was used to determine  $y_{i,corr}$ .

The algorithms for calculating axis intercepts and slopes as well as their variance by means of orthogonal regression are described in detail in the annex to [8].

concerning c)

The values of the slope  $b$  and the axis intercept  $a$  may be used as a correction terms to correct all input values  $y_i$  according to the following equation:

$$y_{i,corr} = \frac{y_i - a}{b}$$

The corrected values  $y_{i,corr}$  may then serve to calculate the following new terms using a new linear regression:

$$y_{i,corr} = c + dx_i$$

and

$$u_{y_{i,corr}}^2 = \frac{RSS}{(n-2)} - u_{RM}^2 + [c + (d-1)L]^2 + L^2 u^2(b) + u^2(a)$$

where  $u(b)$  = uncertainty of the original slope  $b$ , whose value was used to determine  $y_{i,corr}$  and  $u(a)$  = uncertainty of the original axis intercept  $a$ , whose value was used to determine  $y_{i,corr}$ .

The algorithms for calculating axis intercepts and slopes as well as their variance by means of orthogonal regression are described in detail in the annex to [8].

The values for  $u_{c,s,corr}$  are then used to calculate the combined relative uncertainty of the AMS after correction in accordance with the following equation:

$$W_{AMS,corr}^2 = \frac{u_{corr,y_i=L}^2}{L^2}$$

The uncertainty  $W_{AMS,corr}$  for the corrected data set is calculated at the 24h limit value using  $y_i$  as concentration at the limit value.

The relative expanded uncertainty  $W_{AMS,corr}$  is calculated using the following equation:

$$W_{AMS',corr} = k \cdot W_{AMS,corr}$$

In practice,  $k$  is specified at  $k=2$  for large  $n$ .

The largest resulting uncertainty  $W_{AMS,corr}$  is compared and assessed against the criteria for data quality of air quality measurements in accordance with EU Directive [7]. Two situations are conceivable:

1.  $W_{AMS,corr} \leq W_{dqo}$  → The tested instrument is deemed equivalent to the reference method.
2.  $W_{AMS,corr} > W_{dqo}$  → The tested instrument is not deemed equivalent to the reference method.

The expanded relative uncertainty  $W_{dqo}$  specified is 25% [7].

## 6.5 Assessment

During the test, the test samples met the requirements for data quality of air quality measurements without applying a correction factor. Nevertheless, correction of the axis intercept led to a slight improvement of the expanded uncertainty for the complete data set.

Criterion satisfied? yes

The evaluation of the full data set for both test specimen results in a significantly different intercept for the component PM<sub>2,5</sub>.

The slope for the entire data set is 1.000. The intercept for the full data set is 0.764 (see Table 21)

In spite of the significant slope identified for the complete data set, a correction does not appear to make sense as the slope of the complete data set to be used for correction is 1.000.

This is why, for the component PM<sub>2,5</sub>, the full data set was only corrected in terms of the slope. All data sets were re-evaluated using the corrected values.

After the correction, all data sets meet the requirements for data quality. The use of a correction factor for the BAM-1020 for PM<sub>2,5</sub> improves the expanded measurement uncertainties only slightly, but does not bring any decisive advantage.

When a measuring system is operated in the context of a measurement grid, the January 2010 version of the Guideline and standard EN 16450 require that the instruments are tested annually at a number of sites which in turn depends on the highest's expanded uncertainty determined during equivalence testing. The criterion used for specifying the number of sites for annual testing is grouped into 5% steps (Guideline [4], Chapter 9.9.2, Table 6 and/or EN 16450 [8], Chapter 8.6.2, Table 5). It should be noted that the highest expanded uncertainty determined for PM<sub>2,5</sub> after applying the correction was in the range 20–25%.

The operator of the measurement grid or the competent authority of a member state is responsible for compliant implementation of the requirements for regular tests as described above. TÜV Rheinland recommends the use of the expanded uncertainty of the full data set for this purpose: 12.7% (PM<sub>2,5</sub> uncorrected data set) and 11.7% (PM<sub>2,5</sub> data set after correcting intercept). This would require annual tests at 3 sites (uncorrected and corrected).

## 6.6 Detailed presentation of test results

Table 23 shows the evaluation results of the equivalence test after applying the correction factor to the full data set.

Table 23: Overview of results of the equivalence test, SN 17010  
S/N 17011, component PM<sub>2,5</sub> after correcting the intercept

| Comparison candidate with reference according to<br>Standard EN 16450:2017 |                  |                     |                     |                   |
|--|------------------|---------------------|---------------------|-------------------|
| Candidate  | BAM-1020         | SN                  | SN 17010 & SN 17011 |                   |
| Status of measured values  | Offset corrected | Limit value         | 30                  | µg/m <sup>3</sup> |
|  |                  | Allowed uncertainty | 25                  | %                 |
| <b>All comparisons</b>   |                  |                     |                     |                   |
| Uncertainty between Reference  | 0.33             |                     |                     | µg/m <sup>3</sup> |
| Uncertainty between Candidates   | 1.38             |                     |                     | µg/m <sup>3</sup> |
| <b>SN 17010 &amp; SN 17011</b>   |                  |                     |                     |                   |
| Number of data pairs   | 248              |                     |                     |                   |
| Slope b  | 1.000            |                     |                     | not significant   |
| Uncertainty of b   | 0.012            |                     |                     |                   |
| Ordinate intercept a   | 0.000            |                     |                     | not significant   |
| Uncertainty of a   | 0.204            |                     |                     |                   |
| Expanded meas. uncertainty W <sub>CM</sub>                                 | 11.67            |                     |                     | %                 |
| <b>All comparisons, ≥18 µg/m<sup>3</sup></b>                               |                  |                     |                     |                   |
| Uncertainty between Reference  | 0.30             |                     |                     | µg/m <sup>3</sup> |
| Uncertainty between Candidates   | 1.57             |                     |                     | µg/m <sup>3</sup> |
| <b>SN 17010 &amp; SN 17011</b>   |                  |                     |                     |                   |
| Number of data pairs   | 74               |                     |                     |                   |
| Slope b  | 1.031            |                     |                     |                   |
| Uncertainty of b   | 0.033            |                     |                     |                   |
| Ordinate intercept a   | -0.832           |                     |                     |                   |
| Uncertainty of a   | 0.919            |                     |                     |                   |
| Expanded meas. uncertainty W <sub>CM</sub>                                 | 15.00            |                     |                     | %                 |
| <b>All comparisons, &lt;18 µg/m<sup>3</sup></b>                            |                  |                     |                     |                   |
| Uncertainty between Reference  | 0.34             |                     |                     | µg/m <sup>3</sup> |
| Uncertainty between Candidates   | 1.05             |                     |                     | µg/m <sup>3</sup> |
| <b>SN 17010 &amp; SN 17011</b>   |                  |                     |                     |                   |
| Number of data pairs   | 174              |                     |                     |                   |
| Slope b  | 0.971            |                     |                     |                   |
| Uncertainty of b   | 0.025            |                     |                     |                   |
| Ordinate intercept a   | 0.302            |                     |                     |                   |
| Uncertainty of a   | 0.267            |                     |                     |                   |
| Expanded meas. uncertainty W <sub>CM</sub>                                 | 10.64            |                     |                     | %                 |

Addendum to the report on performance testing, report no. 936/21209919/A of  
26 March 2010 for the BAM-1020 with PM2,5 pre-separator for suspended  
particulate matter PM2,5 manufactured by Met One Instruments, Inc.,  
Report No. 936/21243375/A

Page 105 of 160

| Comparison candidate with reference according to<br>Standard EN 16450:2017 |                  |                     |                     |                   |
|--|------------------|---------------------|---------------------|-------------------|
| Candidate  | BAM-1020         | SN                  | SN 17010 & SN 17011 |                   |
| Status of measured values  | Offset corrected | Limit value         | 30                  | µg/m <sup>3</sup> |
|  |                  | Allowed uncertainty | 25                  | %                 |
| <b>Teddington, Summer</b>  |                  |                     |                     |                   |
| Uncertainty between Reference  | 0.33             | µg/m <sup>3</sup>   |                     |                   |
| Uncertainty between Candidates   | 1.13             | µg/m <sup>3</sup>   |                     |                   |
|  | SN 17010         |                     | SN 17011            |                   |
| Number of data pairs   | 78               |                     | 78                  |                   |
| Slope b  | 0.994            |                     | 1.016               |                   |
| Uncertainty of b   | 0.030            |                     | 0.025               |                   |
| Ordinate intercept a   | 1.058            |                     | 0.254               |                   |
| Uncertainty of a   | 0.372            |                     | 0.308               |                   |
| Expanded meas. uncertainty W <sub>CM</sub>                                 | 14.54            | %                   | 11.95               | %                 |
| <b>Cologne, Winter</b>   |                  |                     |                     |                   |
| Uncertainty between Reference  | 0.39             | µg/m <sup>3</sup>   |                     |                   |
| Uncertainty between Candidates   | 1.76             | µg/m <sup>3</sup>   |                     |                   |
|  | SN 17010         |                     | SN 17011            |                   |
| Number of data pairs   | 75               |                     | 75                  |                   |
| Slope b  | 0.980            |                     | 1.061               |                   |
| Uncertainty of b   | 0.024            |                     | 0.019               |                   |
| Ordinate intercept a   | 0.196            |                     | -0.334              |                   |
| Uncertainty of a   | 0.512            |                     | 0.405               |                   |
| Expanded meas. uncertainty W <sub>CM</sub>                                 | 13.08            | %                   | 14.12               | %                 |
| <b>Bornheim, Summer</b>  |                  |                     |                     |                   |
| Uncertainty between Reference  | 0.30             | µg/m <sup>3</sup>   |                     |                   |
| Uncertainty between Candidates   | 1.13             | µg/m <sup>3</sup>   |                     |                   |
|  | SN 17010         |                     | SN 17011            |                   |
| Number of data pairs   | 53               |                     | 57                  |                   |
| Slope b  | 1.052            |                     | 1.134               |                   |
| Uncertainty of b   | 0.036            |                     | 0.048               |                   |
| Ordinate intercept a   | -1.726           |                     | -2.262              |                   |
| Uncertainty of a   | 0.527            |                     | 0.727               |                   |
| Expanded meas. uncertainty W <sub>CM</sub>                                 | 11.17            | %                   | 20.77               | %                 |
| <b>Teddington, Winter</b>  |                  |                     |                     |                   |
| Uncertainty between Reference  | 0.27             | µg/m <sup>3</sup>   |                     |                   |
| Uncertainty between Candidates   | 1.01             | µg/m <sup>3</sup>   |                     |                   |
|  | SN 17010         |                     | SN 17011            |                   |
| Number of data pairs   | 45               |                     | 43                  |                   |
| Slope b  | 0.970            |                     | 0.991               |                   |
| Uncertainty of b   | 0.014            |                     | 0.014               |                   |
| Ordinate intercept a   | -0.946           |                     | -0.134              |                   |
| Uncertainty of a   | 0.300            |                     | 0.293               |                   |
| Expanded meas. uncertainty W <sub>CM</sub>                                 | 14.46            | %                   | 7.70                | %                 |
| <b>All comparisons, ≥18 µg/m<sup>3</sup></b>                               |                  |                     |                     |                   |
| Uncertainty between Reference  | 0.30             | µg/m <sup>3</sup>   |                     |                   |
| Uncertainty between Candidates   | 1.57             | µg/m <sup>3</sup>   |                     |                   |
|  | SN 17010         |                     | SN 17011            |                   |
| Number of data pairs   | 76               |                     | 75                  |                   |
| Slope b  | 0.984            |                     | 1.092               |                   |
| Uncertainty of b   | 0.035            |                     | 0.034               |                   |
| Ordinate intercept a   | -0.180           |                     | -1.872              |                   |
| Uncertainty of a   | 0.975            |                     | 0.95                |                   |
| Expanded meas. uncertainty W <sub>CM</sub>                                 | 16.73            | %                   | 16.73               | %                 |
| <b>All comparisons, &lt;18 µg/m<sup>3</sup></b>                            |                  |                     |                     |                   |
| Uncertainty between Reference  | 0.34             | µg/m <sup>3</sup>   |                     |                   |
| Uncertainty between Candidates   | 1.05             | µg/m <sup>3</sup>   |                     |                   |
|  | SN 17010         |                     | SN 17011            |                   |
| Number of data pairs   | 175              |                     | 178                 |                   |
| Slope b  | 0.955            |                     | 1.021               |                   |
| Uncertainty of b   | 0.028            |                     | 0.026               |                   |
| Ordinate intercept a   | 0.373            |                     | -0.130              |                   |
| Uncertainty of a   | 0.306            |                     | 0.286               |                   |
| Expanded meas. uncertainty W <sub>CM</sub>                                 | 13.31            | %                   | 11.22               | %                 |
| <b>All comparisons</b>   |                  |                     |                     |                   |
| Uncertainty between Reference  | 0.33             | µg/m <sup>3</sup>   |                     |                   |
| Uncertainty between Candidates   | 1.38             | µg/m <sup>3</sup>   |                     |                   |
|  | SN 17010         |                     | SN 17011            |                   |
| Number of data pairs   | 251              |                     | 253                 |                   |
| Slope b  | 0.969            | significant         | 1.041               | significant       |
| Uncertainty of b   | 0.013            |                     | 0.012               |                   |
| Ordinate intercept a   | 0.225            | not significant     | -0.387              | not significant   |
| Uncertainty of a   | 0.226            |                     | 0.214               |                   |
| Expanded meas. uncertainty W <sub>CM</sub>                                 | 13.87            | %                   | 13.61               | %                 |

## **6.1 18 Maintenance interval (7.5.7)**

*The maintenance interval shall be at least 2 weeks.*

## **6.2 Equipment**

Not required for this performance criterion.

## **6.3 Testing**

With regard to this minimum requirement, the maintenance tasks required in a specific period and the length of that period for the correct functioning of the measuring system were identified.

Moreover, the results of the zero drift tests in accordance with 6.1 12 Zero checks (7.5.3) were taken into account when determining the maintenance interval .

## **6.4 Evaluation**

Over the entire period of the field test, no unacceptable drift was observed.

The maintenance interval is thus determined by the necessary maintenance works.

1. Checking the operational status  
The instrument status can be verified by checking the AMS; alternatively it can be monitored online.
2. The sampling inlet must in principle be cleaned in accordance with the manufacturer's instructions, taking into account the local suspended particulate concentrations (every 4 weeks in the performance test).
3. Clean the instrument every month This also applies to cleaning the area of the inlet nozzle above the filter tape. In any case, the measuring system must be cleaned after every measurement application.
4. Check of the filter tape stock – a 21 m-filter tape is usually sufficient for approximately 60 days for a measurement cycle set to 60 min. It is recommended to check the filter tape stock routinely at every visit of the measurement site.
5. According to the manufacturer, a flow rate check and a leak check should be carried out every 4 weeks. Furthermore, a plausibility check of the ambient temperature and air pressure measurement is recommended. This can be done together with the other work carried out according to number 4.
6. Replace the filter tape after approx. 2 months (measurement cycle: 60 min). After the replacement, it is strongly recommended to perform a self test as described in chapter 3.5 of the manual.
7. According to the manufacturer, the calibration of the flow rate should be performed every 3 months.
8. The muffler at the pump should be replaced semi-annually.
9. The sensors for ambient temperature, air pressure, filter temperature and filter rH must be checked every 6 months according to the operating manual.
10. The sample heater must be checked every 6 months according to the operating manual.
11. A 72-hour BKGD test should be performed annually using the BX-302 Zero Filter Kit as described in section 7.7 of the manual.
12. Once a year, the carbon vanes of the vacuum pump (only rotary vane pump) have to be checked and replaced if necessary during an annual maintenance.

Addendum to the report on performance testing, report no. 936/21209919/A of 26 March 2010 for the BAM-1020 with PM2,5 pre-separator for suspended particulate matter PM2,5 manufactured by Met One Instruments, Inc., Report No. 936/21243375/A

Page 107 of 160

13. During the annual basic maintenance, care must also be taken to clean the sampling tube.

The instructions in the manual (chapter 7) must be observed when carrying out maintenance work. All work can generally be carried out with standard tools. During operation times, maintenance may be limited to contamination and plausibility checks and potential status/error messages.

## **6.5 Assessment**

The period of unattended operation is determined by the necessary maintenance works. It is 4 weeks.

Criterion satisfied? yes

## **6.6 Detailed presentation of test results**

The necessary maintenance works are listed in chapter 7 of the operation manual.



## 6.1 19 Automatic diagnostic check (7.5.4)

*Results of automated/functional checks, where available, shall be recorded.*

## 6.2 Equipment

Not required for this performance criterion.

## 6.3 Testing

The current operating status of the measuring system is continuously monitored and any issues will be flagged via a series of different error messages. The current state of monitored parameters can be displayed on the instrument itself and is recorded as part of data logging. When a monitored parameter falls outside the permissible ranges of tolerance, an error bit appears.

The measuring system offers the possibility of an internal check of the zero point and the sensitivity:

The count rates  $I_1$  and  $I_{1x}$ , which were determined on a clean filter tape spot at every measurement cycle were used to check the zero point of the radiometric measurement (see chapter 3.2 Functioning of the measuring system). The zero point of the radiometric measurement is determined according to the following equation:

$$C_0 [\text{mg} / \text{m}^3] = \frac{A}{Q} * \frac{K}{\mu_2} * \ln\left(\frac{I_1}{I_{1x}}\right)$$

$C_0$  is the particle mass concentration at ZP       $A$  is the particle collection area (filter spot)

$Q$  is the sampling flow rate       $K, \mu_2$  are coefficients for beta measurement

$I_1$  is the initial beta count rate       $I_{1x}$  is the final beta count rate

To check the stability of the sensitivity of the radiometric measurement, the count rates  $I_1$  (clean filter spot) or  $I_2$  (clean filter spot + retracted reference foil) determined during each measurement cycle are used (see chapter 3.2 Functioning of the measuring system). The mass density  $m$  [ $\mu\text{g}/\text{cm}^2$ ] of the span foil is calculated internally from the count rates determined. The value is continuously compared with the target value ABS determined in the factory and an error message is generated in the event of a deviation exceeding 5 %.

The instrument thus offers the possibility to determine the zero point as well as the reference value for each measuring cycle (here once an hour) within the instrument. The obtained hourly values at the zero point and span point are output via the serial interface and are easily available for evaluation with a spreadsheet programme.

## **6.4 Evaluation**

All instrument functions described in the operation manual are available and can be activated. The current operating status is continuously monitored and any issues will be flagged via a series of different warning messages. It is possible to automatically check and record the zero point and sensitivity.

## **6.5 Assessment**

All instrument functions described in the operation manual are available and can be activated. The current operating status is continuously monitored and any issues will be flagged via a series of different warning messages. It is possible to automatically check and record the zero point and sensitivity.

Criterion satisfied? yes

## **6.6 Detailed presentation of test results**

Available status signals are listed in chapter 6 of the operation manual.

## **6.1 20 Checks of temperature sensors, pressure and/or humidity sensors**

*The verifiability of temperature sensors, pressure and/or humidity sensors shall be checked for the AMS. Deviations determined shall be within the following criteria:*

$T \pm 2 \text{ }^\circ\text{C}$

$p \pm 1 \text{ kPa}$

$rF \pm 5 \%$

## **6.2 Equipment**

Not required for this performance criterion.

## **6.3 Testing**

This minimum requirement serves to verify whether AMS sensors for temperature, pressure and humidity, which are necessary for correct AMS performance, are accessible and can be checked at the field test site location. In the event, checks cannot be performed on-site, this has to be documented.

## **6.4 Evaluation**

The BAM-1020 measuring systems use meteorological sensors to measure ambient temperature and air pressure (BX-596 or BX-592) for mass flow control, among other things. In addition, the relative humidity is measured in the area of the filter tape (control of the sample heating).

The manufacturer of the weather station indicates the sensors' accuracy as follows:  $\pm 1.5^\circ\text{K}$  (ambient temperature),  $\pm 4\%$  (relative humidity)  $\pm 0.25 \text{ mmHg}$ , which corresponds to  $0.03 \text{ kPa}$ , (air pressure).

Relying on transfer standards, it is easily possible to perform comparison measurements on-site at any time and to adjust the sensors in the event of any deviation.

## **6.5 Assessment**

It is easy to check and adjust the sensors for determining ambient temperature, ambient pressure and relative humidity on-site (filter band area).

Criterion satisfied? yes

## **6.6 Detailed presentation of test results**

Not required for this performance criterion.

## **7. Recommendations for use in practice**

### **7.1 Tasks to be performed in the maintenance interval (4 weeks)**

The tested measuring systems require regular performance of the following tasks:

- Regular visual inspections/telemetric inspections
- Instrument status ok
- No error messages
- No contaminations
- Check of the instrument functions according to the instructions of the manufacturer
- Check of filter tape stock
- Maintenance of the sampling inlet according to the manufacturer's instructions
- Every 4 weeks Plausibility checks of temperature, pressure sensors and, where necessary, readjustment
- Every 4 weeks Leak check and check of the flow rate

Apart from that please consider the manufacturer's instructions.

By default, the measuring system carries out an internal check of the zero point (zero measurement) and the sensitivity (measurement with span foil) for each measuring cycle. The results of these checks can be used for the continuous check of the stability of the radiometric measurement.

## 7.2 Additional maintenance tasks

In addition to the regular tasks to be performed during the maintenance interval, the following tasks need to be performed.

- Replace the filter tape after approx. 2 months (measurement cycle: 60 min). After the replacement, it is strongly recommended to perform a self test as described in chapter 3.5 of the manual.
- According to the manufacturer, the calibration of the flow rate should be performed every 3 months.
- The muffler at the pump should be replaced semi-annually.
- The sensors for ambient temperature, air pressure, filter temperature and filter rH must be checked every 6 months according to the operating manual.
- The sample heater must be checked every 6 months according to the operating manual.
- A 72-hour BKGD test should be performed annually using the BX-302 Zero Filter Kit as described in section 7.7 of the manual.
- Once a year, the carbon vanes of the vacuum pump (only rotary vane pump) have to be checked and replaced if necessary during an annual maintenance.
- During the annual basic maintenance, care must also be taken to clean the sampling tube.

Further details are provided in the operation manual.

Environmental Protection/Air Pollution Control



---

Dipl.-Ing. Guido Baum

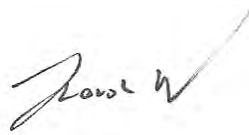

---

Dipl.-Ing. Karsten Pletscher

Cologne, 21 September 2018  
936/21243375/A

## 8. Bibliography

- [1] VDI Guideline 4202, Part 1 – “Performance criteria for performance tests of automated ambient air measuring systems – Point-related measurement methods for gaseous and particulate air pollutants,” dated June 2002.
- [2] VDI Guideline 4203, part 3 – “Testing of automated measuring systems – Test procedures for point-related ambient air measuring systems for gaseous and particulate air pollutants”, dated August 2004
- [3] European standard EN 14907, “Ambient air quality – Standard gravimetric measurement method for the determination of PM<sub>2.5</sub> mass fraction of suspended particulate matter”, German version EN 14907: 2005
- [4] Guideline “Demonstration of Equivalence of Ambient Air Monitoring Methods”, English version of January 2009 or of January 2010
- [5] BAM-1020 operation manual version W
- [6] Operation manual LVS3 of 2000
- [7] Directive 2008/50/EC of the European Parliament and of the Council of 21 May 2008 on ambient air quality and cleaner air for Europe
- [8] European standard EN 16450 “Ambient air – Automated measuring systems for the measurement of the concentration of particulate matter (PM<sub>10</sub>; PM<sub>2.5</sub>, German version dated July 2017)
- [9] TÜV Rheinland Report No. 936/21209919/A dated 26 March 2010; Report on the performance test of the BAM-1020 measuring system with PM<sub>2.5</sub> pre-separator for suspended particulate matter PM<sub>2.5</sub> manufactured by Met One Instruments, Inc.
- [10] Statement issued by TÜV Rheinland Energie und Umwelt GmbH dated 25 September 2010
- [11] Statement issued by TÜV Rheinland Energie und Umwelt GmbH dated 24 March 2011
- [12] Statement issued by TÜV Rheinland Energie und Umwelt GmbH dated 21 March 2012
- [13] Statement issued by TÜV Rheinland Energie und Umwelt GmbH dated 18 March 2013
- [14] Statement issued by TÜV Rheinland Energie und Umwelt GmbH dated 20 September 2014
- [15] Statement issued by TÜV Rheinland Energy GmbH dated 18 August 2017

Hersteller:  
Met One Instruments, Inc., Grants Pass, USA

Eignung:  
Zur kontinuierlichen Immissionsmessung der PM2,5-Fraktion im Schwebstaub im  
stationären Einsatz

Messbereich in der Eignungsprüfung:

| Komponente | Zertifizierungs-<br>bereich | zusätzlicher<br>Messbereich | Einheit           |
|------------|-----------------------------|-----------------------------|-------------------|
| PM 2,5     | 0 - 1000                    | -                           | µg/m <sup>3</sup> |

Softwareversion: Version 3236-07 5.0.10

Einschränkung:  
Bei der Überprüfung der Dichtheit des Probenahmesystems wurden in der  
Eignungsprüfung die Werte 1,8% und 2,4% ermittelt. In der  
Mindestanforderung darf die Undichtigkeit nicht mehr als 1% vom  
durchgesaugten Probevolumen betragen.

Hinweise:

1. Die Anforderungen gemäß des Leitfadens Demonstration of Equivalence of Ambient Air Monitoring Methods werden für die Messkomponente PM2,5 eingehalten.
2. Das Gerät ist zur Erfassung von PM2,5 mit folgenden Optionen auszustatten:  
Probenahmeheizung (BX-830), PM10-Probenahmekopf (BX-802), PM2,5 Sharp Cut Cyclone SCC (BX-807), kombinierter Druck- und Temperatursensor (BX-596) bzw. alternativ Umgebungstemperatursensor (BX-592).
3. Die Zykluszeit während der Eignungsprüfung betrug 1 h, d.h. jede Stunde wurde ein automatischer Filterwechsel durchgeführt. Jeder Filterfleck wurde nur einmal beprobt.
4. Die Probenahmezeit innerhalb der Zykluszeit beträgt 42 min.
5. Die Messeinrichtung ist in einem verschließbaren Messcontainer zu betreiben.
6. Die Messeinrichtung ist mit dem gravimetrischen PM2,5-Referenzverfahren nach DIN EN 14907 regelmäßig am Standort zu kalibrieren.
7. Die Messeinrichtung wird baugleich von der Firma Horiba -Europe GmbH, 61440 Oberursel unter dem Namen APDA-371 mit PM2,5-Vorabscheider vertrieben.

Prüfinstitut:  
TÜV Rheinland Immissionsschutz und Energiesysteme GmbH, Köln  
Bericht-Nr.: 936/21209919/A vom 26. März 2010

Figure 51: Initial announcement BAnz. of 28 July 2010, p. 2597, Chapter II Number 1.1



Addendum to the report on performance testing, report no. 936/21209919/A of 26 March 2010 for the BAM-1020 with PM<sub>2,5</sub> pre-separator for suspended particulate matter PM<sub>2,5</sub> manufactured by Met One Instruments, Inc., Report No. 936/21243375/A

Page 115 of 160

**18 Mitteilung zur Bekanntmachung des Umweltbundesamtes vom 12. Juli 2010 (BAnz. S. 2597, Kapitel II Nummer 1.1)**

Für die Messeinrichtung BAM 1020 mit PM<sub>2,5</sub>-Vorabscheider der Fa. Met One Instruments werden die Anforderungen an die Dichtheit des Probenahmesystems nach einer Neubewertung eingehalten. Die Messeinrichtung erfüllt ebenfalls die Anforderungen des Leitfadens Demonstration of Equivalence of Ambient Air Monitoring Methods in der Version vom Januar 2010.  
Stellungnahme der TÜV Rheinland Energie und Umwelt GmbH vom 25. September 2010

Figure 52: UBA announcement BAnz. of 26 January 2011, p. 294, Chapter IV 18<sup>th</sup> Notification

**11. Mitteilung zu Bekanntmachungen des Umweltbundesamtes vom 12. Juli 2010 (BAnz. S. 2597, Kapitel II Nummer 1.1) und vom 10. Januar 2011 (BAnz. S. 294, Kapitel IV 18. Mitteilung)**

Die Messeinrichtung BAM-1020 mit PM<sub>2,5</sub>-Vorabscheider der Firma Met One Instruments, Inc. für die Messkomponente Schwebstaub PM<sub>2,5</sub> kann optional mit der Pumpe BX-125 betrieben werden. Die Messeinrichtung kann optional mit einem Touch Screen Display (Option BX-970) ausgerüstet werden. Die aktuelle Softwareversion lautet:  
3236-77 V5.1.0

Die Softwareversion für die Messeinrichtung ohne Option BX-970 Touch Screen Display lautet weiterhin 3236-07 5.0.10.

Stellungnahme der TÜV Rheinland Energie und Umwelt GmbH vom 24. März 2011

Figure 53: UBA announcement BAnz. of 29 July 2011, p. 2725, Chapter III 11<sup>th</sup> Notification

**5 Mitteilung zu Bekanntmachungen des Umweltbundesamtes vom 12. Juli 2010 (BAnz. S. 2597, Kapitel II Nummer 1.1) und vom 15. Juli 2011 (BAnz. S. 2725, Kapitel III 11. Mitteilung)**

Die Messeinrichtung BAM-1020 mit PM<sub>2,5</sub>-Vorabscheider der Firma Met One Instruments, Inc. für die Messkomponente Schwebstaub PM<sub>2,5</sub> erhält eine neu designte Rückplatte um die erweiterten Schnittstellen u. a. des optionalen Reportprozessors BX-965 unterzubringen.

Die aktuelle Softwareversion der Messeinrichtung lautet:

3236-07 5.0.15

Die aktuelle Softwareversion der Messeinrichtung mit Touch Screen Display (Option BX-970) lautet:

3236-77 V5.1.2

Stellungnahme der TÜV Rheinland Energie und Umwelt GmbH vom 21. März 2012

Figure 54: UBA announcement BAnz AT 20.07.2012 B11 chapter IV 5<sup>th</sup> Notification

**4 Mitteilung zu den Bekanntmachungen des Umweltbundesamtes vom 12. Juli 2010 (BAnz. S. 2597, Kapitel II Nummer 1.1) und vom 6. Juli 2012 (BAnz AT 20.07.2012 B11, Kapitel IV 5. Mitteilung)**

Die aktuelle Softwareversion der Messeinrichtung BAM-1020 mit PM<sub>2,5</sub>-Vorabscheider der Firma Met One Instruments, Inc. für die Messkomponente Schwebstaub PM<sub>2,5</sub> lautet:

3236-07 5.1.1

Die aktuelle Softwareversion der Messeinrichtung mit Touch Screen Display (Option BX-970) lautet:

3236-77 V5.2.0

Stellungnahme der TÜV Rheinland Energie und Umwelt GmbH vom 18. März 2013

Figure 55: UBA announcement BAnz AT 23.07.2013 B4 chapter V 4<sup>th</sup> Notification



**12 Mitteilung zu den Bekanntmachungen des Umweltbundesamtes vom 12. Juli 2010 (BAnz. S. 2597, Kapitel II Nummer 1.1) und vom 3. Juli 2013 (BAnz AT 23.07.2013 B4, Kapitel V 4. Mitteilung)**

Der Drucksensor 970603 (MICROSWITCH #185PC15AT) in der Messeinrichtung BAM-1020 mit PM<sub>2,5</sub>-Vorabscheider der Fa. Met One Instruments, Inc. wurde abgekündigt und durch den Drucksensor 970595 (HONEYWELL SSCDANN015PAAA5) ersetzt.

Stellungnahme der TÜV Rheinland Energie und Umwelt GmbH vom 20. September 2014

Figure 56: UBA announcement BAnz AT 02.04.2015 B5 chapter IV 12<sup>th</sup> Notification

**9 Mitteilung zu den Bekanntmachungen des Umweltbundesamtes vom 12. Juli 2010 (BAnz. S. 2597, Kapitel II Nummer 1.1) und vom 25. Februar 2015 (BAnz AT 02.04.2015 B5, Kapitel IV 12. Mitteilung)**

Die aktuelle Softwareversion der Messeinrichtung BAM-1020 mit PM<sub>2,5</sub>-Vorabscheider der Firma Met One Instruments, Inc. lautet:

3236-07 5.5.0

Die aktuelle Softwareversion der Messeinrichtung mit Touch Screen Display (Option BX-970) lautet:

3236-77 V5.2.0

Stellungnahme der TÜV Rheinland Energy GmbH vom 18. August 2017

Figure 57: UBA announcement BAnz AT 26.03.2018 B8 chapter V 9<sup>th</sup> Notification

Addendum to the report on performance testing, report no. 936/21209919/A of 26 March 2010 for the BAM-1020 with PM<sub>2,5</sub> pre-separator for suspended particulate matter PM<sub>2,5</sub> manufactured by Met One Instruments, Inc., Report No. 936/21243375/A

Page 117 of 160

## **9. Appendices**

### **Annex 1 Measured and calculated values**

- Schedule 1: Zero level and detection limit
- Schedule 2: Flow rate accuracy
- Schedule 3: Temperature dependence of the zero point and sensitivity
- Schedule 4: Independence of supply voltage
- Annex 5: Measured values from the field test sites
- Schedule 6: Ambient condition at the field test locations

### **Annex 2: Methods used for filter weighing**

### **Annex 3 Operation manuals**

**Annex 1**

**Detection limit**

| <b>Manufacturer</b> Met One Instruments |                             |   |                             |   |
|---|-----------------------------|---|-----------------------------|---|
| <b>Type</b> BAM-1020                    |                             | <b>Standards</b> ZP Measured values with zero filter      |                             |   |
| <b>Serial-No.</b> SN X14465 / SN X14499 |                             |   |                             |   |
| No.                                     | Date                        | Measured values [ $\mu\text{g}/\text{m}^3$ ]<br>SN X14465 | Date                        | Measured values [ $\mu\text{g}/\text{m}^3$ ]<br>SN X14499 |
| 1                                       | 7/22/2018                   | -0.2  | 7/22/2018                   | 0.1   |
| 2                                       | 7/23/2018                   | 0.0   | 7/23/2018                   | -0.4  |
| 3                                       | 7/24/2018                   | 0.0   | 7/24/2018                   | 0.0   |
| 4                                       | 7/25/2018                   | 0.5   | 7/25/2018                   | 0.0   |
| 5                                       | 7/26/2018                   | 0.2   | 7/26/2018                   | 0.1   |
| 6                                       | 7/27/2018                   | 0.6   | 7/27/2018                   | 0.0   |
| 7                                       | 7/28/2018                   | -0.1  | 7/28/2018                   | 0.3   |
| 8                                       | 7/29/2018                   | -0.3  | 7/29/2018                   | -0.4  |
| 9                                       | 7/30/2018                   | 0.0   | 7/30/2018                   | -0.6  |
| 10                                      | 7/31/2018                   | 0.5   | 7/31/2018                   | 0.7   |
| 11                                      | 8/1/2018                    | 0.0   | 8/1/2018                    | 1.3   |
| 12                                      | 8/2/2018                    | 1.3   | 8/2/2018                    | 0.4   |
| 13                                      | 8/3/2018                    | 0.7   | 8/3/2018                    | 0.8   |
| 14                                      | 8/4/2018                    | 0.3   | 8/4/2018                    | 1.1   |
| 15                                      | 8/5/2018                    | 0.4   | 8/5/2018                    | 0.2   |
|   | No. of values               | 15  | No. of values               | 15  |
|   | Mean                        | 0.27  | Mean                        | 0.23  |
|   | Standard deviation $s_{x0}$ | 0.42  | Standard deviation $s_{x0}$ | 0.53  |
|   | Detection limit x           | 1.37  | Detection limit x           | 1.75  |

$$s_{x0} = \sqrt{\left(\frac{1}{n-1}\right) \cdot \sum_{i=1,n} (x_{0i} - \bar{x}_0)^2}$$

Addendum to the report on performance testing, report no. 936/21209919/A of 26 March 2010 for the BAM-1020 with PM2,5 pre-separator for suspended particulate matter PM2,5 manufactured by Met One Instruments, Inc., Report No.: 936/21243375/A

**Annex 2**

**Flow rate accuracy**

|                     |      |                       |                |                        |              |                                  |                        |       |  |
|---------------------|------|-----------------------|----------------|------------------------|--------------|----------------------------------|------------------------|-------|--|
| <b>Manufacturer</b> |      | Met One Instruments   |                |                        |              | <b>Nominal flow rate [l/min]</b> |                        | 16.67 |  |
| <b>Type</b>         |      | BAM-1020              |                |                        |              |                                  |                        |       |  |
| <b>Serial-No.</b>   |      | SN X14465 / SN X14499 |                |                        |              |                                  |                        |       |  |
| Temperature 1       | 5°C  | SN X14465             |                |                        | SN X14499    |                                  |                        |       |  |
|                     |      | No.                   | Date/Time      | Measured value [l/min] | No.          | Date/Time                        | Measured value [l/min] |       |  |
|                     |      | 1                     | 8/15/2018 6:11 | 16.46                  | 1            | 8/15/2018 6:13                   | 16.36                  |       |  |
|                     |      | 2                     | 8/15/2018 6:15 | 16.44                  | 2            | 8/15/2018 6:17                   | 16.34                  |       |  |
|                     |      | 3                     | 8/15/2018 6:19 | 16.43                  | 3            | 8/15/2018 6:21                   | 16.36                  |       |  |
|                     |      | 4                     | 8/15/2018 6:23 | 16.42                  | 4            | 8/15/2018 6:25                   | 16.35                  |       |  |
|                     |      | 5                     | 8/15/2018 6:27 | 16.42                  | 5            | 8/15/2018 6:29                   | 16.36                  |       |  |
|                     |      | 6                     | 8/15/2018 6:31 | 16.42                  | 6            | 8/15/2018 6:33                   | 16.35                  |       |  |
|                     |      | 7                     | 8/15/2018 6:35 | 16.39                  | 7            | 8/15/2018 6:37                   | 16.34                  |       |  |
|                     |      | 8                     | 8/15/2018 6:39 | 16.40                  | 8            | 8/15/2018 6:41                   | 16.33                  |       |  |
|                     |      | 9                     | 8/15/2018 6:43 | 16.40                  | 9            | 8/15/2018 6:45                   | 16.35                  |       |  |
|                     |      | 10                    | 8/15/2018 6:47 | 16.33                  | 10           | 8/15/2018 6:49                   | 16.34                  |       |  |
|                     |      | <b>Mean</b>           | <b>16.41</b>   | <b>Mean</b>            | <b>16.35</b> |                                  |                        |       |  |
| Temperature 2       | 40°C | SN X14465             |                |                        | SN X14499    |                                  |                        |       |  |
|                     |      | No.                   | Date/Time      | Measured value [l/min] | No.          | Date/Time                        | Measured value [l/min] |       |  |
|                     |      | 1                     | 8/16/2018 6:12 | 16.80                  | 1            | 8/16/2018 6:14                   | 16.84                  |       |  |
|                     |      | 2                     | 8/16/2018 6:16 | 16.86                  | 2            | 8/16/2018 6:18                   | 16.90                  |       |  |
|                     |      | 3                     | 8/16/2018 6:20 | 16.84                  | 3            | 8/16/2018 6:22                   | 16.86                  |       |  |
|                     |      | 4                     | 8/16/2018 6:24 | 16.91                  | 4            | 8/16/2018 6:26                   | 16.91                  |       |  |
|                     |      | 5                     | 8/16/2018 6:28 | 16.87                  | 5            | 8/16/2018 6:30                   | 16.87                  |       |  |
|                     |      | 6                     | 8/16/2018 6:32 | 16.87                  | 6            | 8/16/2018 6:34                   | 16.87                  |       |  |
|                     |      | 7                     | 8/16/2018 6:36 | 16.88                  | 7            | 8/16/2018 6:38                   | 16.86                  |       |  |
|                     |      | 8                     | 8/16/2018 6:40 | 16.86                  | 8            | 8/16/2018 6:42                   | 16.91                  |       |  |
|                     |      | 9                     | 8/16/2018 6:44 | 16.90                  | 9            | 8/16/2018 6:46                   | 16.88                  |       |  |
|                     |      | 10                    | 8/16/2018 6:48 | 16.87                  | 10           | 8/16/2018 6:50                   | 16.86                  |       |  |
|                     |      | <b>Mean</b>           | <b>16.87</b>   | <b>Mean</b>            | <b>16.88</b> |                                  |                        |       |  |

**Annex 3**

**Dependence of zero point on surrounding temperature**

|   |     |                  |                                     |                                     |                                     |   |   |
|---|-----|------------------|-------------------------------------|-------------------------------------|-------------------------------------|---|---|
| <b>Manufacturer</b> Met One Instruments     |     |                  |                                     |                                     |                                     |   |   |
| <b>Type</b> BAM-1020                        |     |                  |                                     |                                     |                                     |   |   |
| <b>Serial-No.</b> SN 17010 / SN 17011       |     |                  |                                     |                                     |                                     |   |   |
| <b>Test period:</b> 30.05.2009 - 17.06.2009 |     |                  |                                     |                                     |                                     |   |   |
|   |     |                  | Measurement 1                       | Measurement 2                       | Measurement 3                       |   |   |
| SN 17010                                    | No. | Temperature [°C] | Measured value [µg/m <sup>3</sup> ] | Measured value [µg/m <sup>3</sup> ] | Measured value [µg/m <sup>3</sup> ] | Mean value of 3 measurements [µg/m <sup>3</sup> ] | Mean value at 20°C [µg/m <sup>3</sup> ] |
| Zero  | 1   | 20               | 1.4                                 | -1.0                                | 0.1                                 | 0.2   | 1.1                                     |
|   | 2   | 5                | 1.6                                 | 1.7                                 | 1.5                                 | 1.6   |   |
|   | 3   | 20               | 0.1                                 | 0.7                                 | 1.1                                 | 0.6   |   |
|   | 4   | 40               | -1.3                                | 2.1                                 | 0.2                                 | 0.3   |   |
|   | 5   | 20               | 2.4                                 | 0.7                                 | 4.5                                 | 2.5   |   |
| SN 17011                                    | No. | Temperature [°C] | Measured value [µg/m <sup>3</sup> ] | Measured value [µg/m <sup>3</sup> ] | Measured value [µg/m <sup>3</sup> ] | Mean value of 3 measurements [µg/m <sup>3</sup> ] | Mean value at 20°C [µg/m <sup>3</sup> ] |
| Zero  | 1   | 20               | -0.7                                | -0.7                                | -1.6                                | -1.0  | -1.1                                    |
|   | 2   | 5                | -0.4                                | -0.5                                | -0.1                                | -0.3  |   |
|   | 3   | 20               | -1.6                                | -1.0                                | -0.7                                | -1.1  |   |
|   | 4   | 40               | -2.5                                | -3.0                                | -3.2                                | -2.9  |   |
|   | 5   | 20               | -1.7                                | -1.0                                | -1.2                                | -1.3  |   |

**Annex 3**

**Dependence of span on surrounding temperature**

|   |     |   |   |   |   |   |   |
|---|-----|---|---|---|---|---|---|
| <b>Manufacturer</b> Met One Instruments     |     | <b>Used test standard</b> internal reference foil |   |   |   |   |   |
| <b>Type</b> BAM-1020                        |     |   |   |   |   |   |   |
| <b>Serial-No.</b> SN 17010 / SN 17011       |     |   |   |   |   |   |   |
| <b>Test period:</b> 30.05.2009 - 17.06.2009 |     | Measurement 1                                     |   | Measurement 2                           |   | Measurement 3   |   |
| SN 17010                                    | No. | Temperature<br>[°C]                               | Measured value<br>[µg/cm <sup>3</sup> ] | Measured value<br>[µg/cm <sup>3</sup> ] | Measured value<br>[µg/cm <sup>3</sup> ] | Mean value of 3 measurements<br>[µg/cm <sup>3</sup> ] | Mean value at 20°C<br>[µg/cm <sup>3</sup> ] |
| Span  | 1   | 20  | 829.8                                   | 829.7                                   | 829.6                                   | 829.7   | 829.6                                       |
|   | 2   | 5   | 829.4                                   | 829.3                                   | 829.3                                   | 829.3   |   |
|   | 3   | 20  | 829.6                                   | 829.7                                   | 829.3                                   | 829.5   |   |
|   | 4   | 40  | 830.8                                   | 830.7                                   | 831.8                                   | 831.1   |   |
|   | 5   | 20  | 829.3                                   | 829.6                                   | 829.6                                   | 829.5   |   |
| SN 17011                                    | No. | Temperature<br>[°C]                               | Measured value<br>[µg/cm <sup>3</sup> ] | Measured value<br>[µg/cm <sup>3</sup> ] | Measured value<br>[µg/cm <sup>3</sup> ] | Mean value of 3 measurements<br>[µg/cm <sup>3</sup> ] | Mean value at 20°C<br>[µg/cm <sup>3</sup> ] |
| Span  | 1   | 20  | 822.9                                   | 822.6                                   | 821.9                                   | 822.5   | 823.0                                       |
|   | 2   | 5   | 821.8                                   | 822.4                                   | 823.3                                   | 822.5   |   |
|   | 3   | 20  | 821.9                                   | 823.3                                   | 823.3                                   | 822.8   |   |
|   | 4   | 40  | 823.8                                   | 825.4                                   | 826.4                                   | 825.2   |   |
|   | 5   | 20  | 823.3                                   | 823.7                                   | 823.8                                   | 823.6   |   |

**Annex 4**

**Dependence of span on supply voltage**

|   |     |                   |                     |                     |                     |                                   |   |
|---|-----|-------------------|---------------------|---------------------|---------------------|-----------------------------------|---|
| <b>Manufacturer</b> ABC                 |     |                   |                     |                     |                     |                                   | <b>Used test standard</b> Internal reference foil |
| <b>Type</b> XYZ                         |     |                   |                     |                     |                     |                                   |   |
| <b>Serial-No.</b> SN X14465 / SN X14499 |     |                   |                     |                     |                     |                                   |   |
|   |     |                   | Measurement 1       | Measurement 2       | Measurement 3       |                                   |   |
| SN X14465                               | No. | Mains voltage [V] | Measured value [mg] | Measured value [mg] | Measured value [mg] | Mean value of 3 measurements [mg] |   |
| Span                                    | 1   | 230               | 0.813               | 0.815               | 0.816               | 0.815                             |   |
|   | 2   | 195               | 0.811               | 0.819               | 0.818               | 0.816                             |   |
|   | 3   | 230               | 0.815               | 0.817               | 0.819               | 0.817                             |   |
|   | 4   | 253               | 0.813               | 0.818               | 0.818               | 0.816                             |   |
|   | 5   | 230               | 0.815               | 0.815               | 0.815               | 0.815                             |   |
| SN X14499                               | No. | Mains voltage [V] | Measured value [mg] | Measured value [mg] | Measured value [mg] | Mean value of 3 measurements [mg] |   |
| Span                                    | 1   | 230               | 0.824               | 0.827               | 0.826               | 0.826                             |   |
|   | 2   | 195               | 0.827               | 0.827               | 0.830               | 0.828                             |   |
|   | 3   | 230               | 0.822               | 0.820               | 0.824               | 0.822                             |   |
|   | 4   | 253               | 0.824               | 0.830               | 0.826               | 0.827                             |   |
|   | 5   | 230               | 0.822               | 0.824               | 0.826               | 0.824                             |   |

Addendum to the report on performance testing, report no. 936/21209919/A of 26 March 2010 for the BAM-1020 with PM2,5 pre-separator for suspended particulate matter PM2,5 manufactured by Met One Instruments, Inc., Report No.: 936/21243375/A

Annex 5

Measured values from field test sites, related to actual conditions

| Manufacturer Met One Instruments<br>Type of instrument BAM-1020<br>Serial-No. SN 17010 / SN 17011 |           |                            |                            |                           |                           |                            |                              |                              |                    | PM2,5<br>Measured values in µg/m³ (ACT) |  |
|---|-----------|----------------------------|----------------------------|---------------------------|---------------------------|----------------------------|------------------------------|------------------------------|--------------------|---|--|
| No.   | Date      | Ref. 1<br>PM2,5<br>[µg/m³] | Ref. 2<br>PM2,5<br>[µg/m³] | Ref. 1<br>PM10<br>[µg/m³] | Ref. 2<br>PM10<br>[µg/m³] | Ratio<br>PM2,5/PM10<br>[%] | SN 17010<br>PM2,5<br>[µg/m³] | SN 17011<br>PM2,5<br>[µg/m³] | Remark             | Test site                               |  |
| 1   | 7/24/2008 |                            |                            | 32.9                      | 32.0                      |                            |                              |                              | Zero filter        | Teddington, Summer                      |  |
| 2   | 7/25/2008 | 15.4                       | 15.1                       | 22.5                      | 23.6                      | 65.9                       | 13.6                         | 15.3                         |                    |   |  |
| 3   | 7/26/2008 |                            |                            | 21.0                      | 21.6                      |                            | 15.5                         | 14.1                         | Outlier Ref. PM2,5 |   |  |
| 4   | 7/27/2008 | 13.1                       | 13.2                       | 19.0                      | 19.9                      | 67.8                       | 16.5                         | 15.5                         |                    |   |  |
| 5   | 7/28/2008 | 13.5                       | 13.6                       | 20.3                      | 20.3                      | 66.9                       | 15.0                         | 15.1                         |                    |   |  |
| 6   | 7/29/2008 | 4.2                        | 4.7                        | 11.8                      | 12.1                      | 37.4                       | 7.7                          | 6.0                          |                    |   |  |
| 7   | 7/30/2008 | 9.6                        | 9.5                        | 16.2                      | 16.5                      | 58.4                       | 12.2                         | 9.5                          |                    |   |  |
| 8   | 7/31/2008 | 10.8                       | 11.0                       | 22.2                      | 22.4                      | 49.0                       | 15.2                         | 15.5                         |                    |   |  |
| 9   | 8/1/2008  | 4.2                        | 5.5                        | 16.3                      | 15.5                      | 30.3                       | 9.1                          | 7.7                          |                    |   |  |
| 10  | 8/2/2008  | 2.4                        | 2.2                        |                           |                           |                            | 5.3                          | 4.4                          | Outlier Ref. PM10  |   |  |
| 11  | 8/3/2008  | 2.0                        | 2.5                        | 8.2                       | 8.4                       | 26.8                       | 3.0                          | 4.9                          |                    |   |  |
| 12  | 8/4/2008  | 3.4                        | 4.4                        | 9.4                       | 9.6                       | 41.1                       | 5.2                          | 4.7                          |                    |   |  |
| 13  | 8/5/2008  | 3.1                        | 3.6                        | 7.5                       | 7.3                       | 45.1                       | 8.4                          | 7.0                          |                    |   |  |
| 14  | 8/6/2008  |                            |                            |                           |                           |                            |                              |                              | Power failure      |   |  |
| 15  | 8/7/2008  | 5.4                        | 6.2                        | 11.9                      | 11.4                      | 50.2                       |                              |                              | Power failure      |   |  |
| 16  | 8/8/2008  | 5.2                        | 6.2                        | 9.9                       | 9.6                       | 58.5                       | 7.8                          | 6.7                          |                    |   |  |
| 17  | 8/9/2008  | 2.3                        | 3.3                        | 7.1                       | 7.3                       | 39.3                       | 5.0                          | 6.4                          |                    |   |  |
| 18  | 8/10/2008 | 3.9                        | 4.1                        | 11.7                      | 11.2                      | 34.7                       | 4.0                          | 5.1                          |                    |   |  |
| 19  | 8/11/2008 | 5.6                        | 6.0                        | 13.7                      | 13.5                      | 42.7                       | 6.1                          | 6.4                          |                    |   |  |
| 20  | 8/12/2008 | 3.5                        | 3.5                        | 10.6                      | 10.5                      | 33.2                       | 3.1                          | 3.3                          |                    |   |  |
| 21  | 8/13/2008 | 3.5                        | 3.8                        | 11.8                      | 11.4                      | 31.7                       | 4.2                          | 3.7                          |                    |   |  |
| 22  | 8/14/2008 | 6.1                        | 6.5                        | 11.0                      | 11.1                      | 56.9                       | 7.6                          | 6.0                          |                    |   |  |
| 23  | 8/15/2008 | 5.6                        | 6.3                        | 10.0                      | 11.6                      | 55.4                       | 6.6                          | 5.0                          |                    |   |  |
| 24  | 8/16/2008 | 5.5                        | 5.5                        |                           |                           |                            | 5.7                          | 4.8                          | Outlier Ref. PM10  |   |  |
| 25  | 8/17/2008 | 2.7                        | 2.7                        | 8.7                       | 8.5                       | 31.2                       | 3.7                          | 4.3                          |                    |   |  |
| 26  | 8/18/2008 |                            |                            |                           |                           |                            |                              |                              | Zero filter        |   |  |
| 27  | 8/19/2008 | 4.6                        | 4.7                        | 12.5                      | 13.0                      | 36.6                       | 5.2                          | 7.0                          |                    |   |  |
| 28  | 8/20/2008 | 3.9                        | 4.1                        | 10.2                      | 10.1                      | 39.6                       | 6.4                          | 6.2                          |                    |   |  |
| 29  | 8/21/2008 | 6.5                        | 6.8                        | 13.2                      | 13.5                      | 50.2                       | 8.9                          | 7.5                          |                    |   |  |
| 30  | 8/22/2008 | 5.2                        | 4.9                        | 9.5                       | 9.3                       | 53.6                       | 6.3                          | 5.0                          |                    |   |  |



**Annex 5**

**Measured values from field test sites, related to actual conditions**

| <p><b>Manufacturer</b> Met One Instruments</p> <p><b>Type of instrument</b> BAM-1020</p> <p><b>Serial-No.</b> SN 17010 / SN 17011</p> <th colspan="2"> <p>PM2,5<br/>Measured values in µg/m<sup>3</sup> (ACT)</p> </th> |           |   |   |  |  |                            |   |   |   | <p>PM2,5<br/>Measured values in µg/m<sup>3</sup> (ACT)</p> |  |
|---|-----------|---|---|--|--|----------------------------|---|---|---|--|--|
| No.   | Date      | Ref. 1<br>PM2,5<br>[µg/m <sup>3</sup> ] | Ref. 2<br>PM2,5<br>[µg/m <sup>3</sup> ] | Ref. 1<br>PM10<br>[µg/m <sup>3</sup> ] | Ref. 2<br>PM10<br>[µg/m <sup>3</sup> ] | Ratio<br>PM2,5/PM10<br>[%] | SN 17010<br>PM2,5<br>[µg/m <sup>3</sup> ] | SN 17011<br>PM2,5<br>[µg/m <sup>3</sup> ] | Remark  | Test site  |  |
| 31  | 8/23/2008 | 4.5                                     | 4.4                                     | 9.2                                    | 9.5                                    | 47.4                       | 7.0                                       | 5.6                                       |   | Teddington, Summer   |  |
| 32  | 8/24/2008 | 3.5                                     | 3.5                                     | 8.6                                    | 8.7                                    | 40.3                       | 5.7                                       | 4.3                                       |   |  |  |
| 33  | 8/25/2008 | 6.5                                     | 6.5                                     | 12.9                                   | 13.0                                   | 50.0                       | 10.2                                      | 9.9                                       |   |  |  |
| 34  | 8/26/2008 | 4.8                                     | 4.9                                     | 10.7                                   | 9.5                                    | 47.9                       | 8.3                                       | 7.0                                       |   |  |  |
| 35  | 8/27/2008 | 7.4                                     | 7.0                                     | 13.4                                   | 13.6                                   | 53.2                       | 10.7                                      | 10.4                                      |   |  |  |
| 36  | 8/28/2008 | 9.6                                     | 9.3                                     | 14.1                                   | 14.2                                   | 66.8                       | 12.1                                      | 12.4                                      |   |  |  |
| 37  | 8/29/2008 | 13.7                                    | 12.8                                    | 20.1                                   | 19.1                                   | 67.8                       | 16.8                                      | 19.3                                      |   |  |  |
| 38  | 8/30/2008 | 31.6                                    | 30.5                                    | 43.8                                   | 43.2                                   | 71.4                       | 38.3                                      | 39.2                                      |   |  |  |
| 39  | 8/31/2008 | 13.3                                    | 12.1                                    | 22.0                                   | 21.6                                   | 58.5                       | 18.7                                      | 16.8                                      |   |  |  |
| 40  | 9/1/2008  | 2.9                                     | 2.6                                     | 8.1                                    | 8.1                                    | 33.9                       | 5.5                                       | 4.6                                       |   |  |  |
| 41  | 9/2/2008  | 3.0                                     | 2.4                                     | 11.8                                   | 12.4                                   | 22.3                       | 4.1                                       | 5.0                                       |   |  |  |
| 42  | 9/3/2008  | 3.6                                     | 3.3                                     | 14.2                                   | 14.3                                   | 24.2                       | 5.5                                       | 6.0                                       |   |  |  |
| 43  | 9/4/2008  | 4.1                                     | 3.7                                     |  |  |                            | 6.5                                       | 4.4                                       |   |  |  |
| 44  | 9/5/2008  | 2.6                                     | 2.7                                     | 7.5                                    | 7.6                                    | 35.0                       | 2.7                                       |   | Outlier Ref. PM10<br>Span foil SN 17011 stuck, 4 h loss due to repair |  |  |
| 45  | 9/6/2008  | 3.4                                     | 3.6                                     | 8.0                                    | 7.6                                    | 44.9                       | 4.1                                       | 4.8                                       |   |  |  |
| 46  | 9/7/2008  | 3.1                                     | 2.7                                     | 8.4                                    | 8.2                                    | 34.8                       | 5.8                                       | 4.9                                       |   |  |  |
| 47  | 9/8/2008  | 6.4                                     | 6.6                                     | 14.7                                   | 14.2                                   | 45.0                       | 9.0                                       | 7.5                                       |   |  |  |
| 48  | 9/9/2008  | 6.0                                     | 5.2                                     | 14.4                                   | 14.2                                   | 39.1                       | 8.3                                       | 6.4                                       |   |  |  |
| 49  | 9/10/2008 | 4.3                                     | 4.1                                     | 11.0                                   | 10.6                                   | 38.6                       | 10.1                                      | 6.1                                       |   |  |  |
| 50  | 9/11/2008 | 6.5                                     | 5.4                                     | 17.2                                   | 17.5                                   | 34.2                       | 9.2                                       | 7.0                                       |   |  |  |
| 51  | 9/12/2008 | 5.5                                     | 5.1                                     | 9.4                                    | 9.1                                    | 57.3                       | 8.0                                       | 6.4                                       |   |  |  |
| 52  | 9/13/2008 | 15.5                                    | 15.4                                    | 20.4                                   | 20.7                                   | 75.5                       | 18.8                                      | 16.2                                      |   |  |  |
| 53  | 9/14/2008 | 10.9                                    | 10.3                                    | 18.1                                   | 17.4                                   | 60.0                       | 13.0                                      | 11.2                                      |   |  |  |
| 54  | 9/15/2008 | 11.8                                    | 12.3                                    | 17.5                                   | 17.5                                   | 68.6                       | 12.5                                      | 11.3                                      |   |  |  |
| 55  | 9/16/2008 | 17.7                                    | 17.4                                    | 24.6                                   | 24.2                                   | 72.0                       | 18.5                                      | 17.1                                      |   |  |  |
| 56  | 9/17/2008 | 19.4                                    | 19.2                                    | 26.9                                   | 28.1                                   | 70.3                       | 20.0                                      | 18.6                                      |   |  |  |
| 57  | 9/18/2008 | 17.0                                    | 17.2                                    | 24.5                                   | 23.6                                   | 71.3                       | 17.9                                      | 16.9                                      |   |  |  |
| 58  | 9/19/2008 | 20.7                                    | 20.9                                    | 29.3                                   | 29.4                                   | 70.9                       | 22.9                                      | 21.3                                      |   |  |  |
| 59  | 9/20/2008 | 21.7                                    | 21.4                                    | 26.9                                   | 26.6                                   | 80.6                       | 23.2                                      | 22.4                                      |   |  |  |
| 60  | 9/21/2008 | 21.6                                    | 22.0                                    | 28.6                                   | 28.1                                   | 76.9                       | 23.8                                      | 21.3                                      |   |  |  |

Addendum to the report on performance testing, report no. 936/21209919/A of 26 March 2010 for the BAM-1020 with PM2,5 pre-separator for suspended particulate matter PM2,5 manufactured by Met One Instruments, Inc., Report No.: 936/21243375/A

Annex 5

Measured values from field test sites, related to actual conditions

| Manufacturer Met One Instruments<br>Type of instrument BAM-1020<br>Serial-No. SN 17010 / SN 17011 |            |                            |                            |                           |                           |                            |                              |                              |   |                    |
|---|------------|----------------------------|----------------------------|---------------------------|---------------------------|----------------------------|------------------------------|------------------------------|---|--------------------|
| PM2,5<br>Measured values in µg/m³ (ACT)   |            |                            |                            |                           |                           |                            |                              |                              |   |                    |
| No.   | Date       | Ref. 1<br>PM2,5<br>[µg/m³] | Ref. 2<br>PM2,5<br>[µg/m³] | Ref. 1<br>PM10<br>[µg/m³] | Ref. 2<br>PM10<br>[µg/m³] | Ratio<br>PM2,5/PM10<br>[%] | SN 17010<br>PM2,5<br>[µg/m³] | SN 17011<br>PM2,5<br>[µg/m³] | Remark  | Test site          |
| 61  | 9/22/2008  | 14.8                       | 15.0                       | 22.3                      | 22.6                      | 66.3                       | 17.4                         | 15.3                         | Zero filter<br>Filter tape SN 17010 cut   | Teddington, Summer |
| 62  | 9/23/2008  | 6.3                        | 6.1                        | 18.0                      | 17.8                      | 34.5                       |                              |                              |   |                    |
| 63  | 9/24/2008  | 11.4                       | 11.4                       | 18.8                      | 19.7                      | 59.1                       |                              | 13.5                         |   |                    |
| 64  | 9/25/2008  | 16.1                       | 16.5                       | 26.7                      | 26.4                      | 61.2                       | 19.0                         | 17.9                         |   |                    |
| 65  | 9/26/2008  | 17.5                       | 17.4                       | 29.9                      | 29.7                      | 58.5                       | 21.1                         | 19.4                         |   |                    |
| 66  | 9/27/2008  | 27.2                       | 27.2                       | 35.7                      | 35.6                      | 76.4                       | 29.9                         | 28.4                         |   |                    |
| 67  | 9/28/2008  |                            |                            |                           |                           |                            | 20.4                         | 17.8                         |   |                    |
| 68  | 9/29/2008  | 4.3                        | 4.4                        | 7.4                       | 8.5                       | 54.9                       | 5.3                          | 3.6                          |   |                    |
| 69  | 9/30/2008  | 3.2                        | 3.3                        | 6.9                       | 6.7                       | 48.3                       | 3.9                          | 3.7                          |   |                    |
| 70  | 10/1/2008  |                            |                            |                           |                           |                            | 3.5                          | 2.4                          |   |                    |
| 71  | 10/2/2008  |                            |                            |                           |                           |                            | 5.4                          | 3.9                          |   |                    |
| 72  | 10/3/2008  |                            |                            |                           |                           |                            | 7.3                          | 5.7                          |   |                    |
| 73  | 10/4/2008  |                            |                            |                           |                           |                            | 3.0                          | 1.4                          |   |                    |
| 74  | 10/5/2008  |                            |                            |                           |                           |                            | 5.7                          | 3.7                          |   |                    |
| 75  | 10/6/2008  |                            |                            |                           |                           |                            | 7.5                          | 6.4                          |   |                    |
| 76  | 10/7/2008  |                            |                            |                           |                           |                            | 5.5                          | 5.4                          |   |                    |
| 77  | 10/8/2008  |                            |                            |                           |                           |                            | 14.0                         | 11.3                         |   |                    |
| 78  | 10/9/2008  | 8.9                        | 10.1                       | 18.4                      | 18.0                      | 52.2                       | 11.2                         | 9.8                          |   |                    |
| 79  | 10/10/2008 | 10.5                       | 10.6                       | 19.5                      | 19.6                      | 54.1                       | 12.4                         | 10.8                         |   |                    |
| 80  | 10/11/2008 | 15.6                       | 15.8                       | 22.6                      | 22.6                      | 69.5                       | 20.7                         | 17.8                         |   |                    |
| 81  | 10/12/2008 | 20.4                       | 21.1                       | 25.9                      | 25.9                      | 80.1                       | 23.4                         | 21.5                         |   |                    |
| 82  | 10/13/2008 | 8.3                        | 8.4                        | 14.6                      | 14.4                      | 57.6                       | 10.5                         | 9.5                          |   |                    |
| 83  | 10/14/2008 | 6.1                        | 6.4                        | 11.4                      | 12.2                      | 52.7                       | 10.2                         | 7.1                          |   |                    |
| 84  | 10/15/2008 | 3.9                        | 3.8                        | 8.2                       | 8.6                       | 46.0                       | 5.7                          | 3.1                          |   |                    |
| 85  | 10/16/2008 |                            |                            |                           |                           |                            |                              |                              | Zero filter<br>Not in operation<br>Not in operation<br>Not in operation<br>Not in operation |                    |
| 86  | 10/17/2008 |                            |                            |                           |                           |                            |                              |                              |   |                    |
| 87  | 10/18/2008 |                            |                            |                           |                           |                            |                              |                              |   |                    |
| 88  | 10/19/2008 |                            |                            |                           |                           |                            |                              |                              |   |                    |
| 89  | 10/20/2008 |                            |                            |                           |                           |                            |                              |                              |   |                    |
| 90  | 10/21/2008 |                            |                            |                           |                           |                            | 7.5                          | 7.5                          |   |                    |

**Annex 5**

**Measured values from field test sites, related to actual conditions**

| <b>Manufacturer</b> Met One Instruments<br><b>Type of instrument</b> BAM-1020<br><b>Serial-No.</b> SN 17010 / SN 17011 |            |   |   |  |  |                            |   |   |                   | <b>PM2,5</b><br>Measured values in µg/m <sup>3</sup> (ACT) |
|--|------------|---|---|--|--|----------------------------|---|---|-------------------|--|
| No.  | Date       | Ref. 1<br>PM2,5<br>[µg/m <sup>3</sup> ] | Ref. 2<br>PM2,5<br>[µg/m <sup>3</sup> ] | Ref. 1<br>PM10<br>[µg/m <sup>3</sup> ] | Ref. 2<br>PM10<br>[µg/m <sup>3</sup> ] | Ratio<br>PM2,5/PM10<br>[%] | SN 17010<br>PM2,5<br>[µg/m <sup>3</sup> ] | SN 17011<br>PM2,5<br>[µg/m <sup>3</sup> ] | Remark            | Test site  |
| 91   | 10/22/2008 |   |   |  |  |                            | 8.2                                       | 7.7                                       |                   | Teddington, Summer   |
| 92   | 10/23/2008 |   |   |  |  |                            | 5.4                                       | 4.2                                       |                   |  |
| 93   | 10/24/2008 |   |   |  |  |                            | 12.1                                      | 10.5                                      |                   |  |
| 94   | 10/25/2008 |   |   |  |  |                            | 11.2                                      | 9.5                                       |                   |  |
| 95   | 10/26/2008 |   |   |  |  |                            | 4.4                                       | 2.2                                       |                   |  |
| 96   | 10/27/2008 |   |   |  |  |                            | 11.0                                      | 9.4                                       |                   |  |
| 97   | 10/28/2008 |   |   |  |  |                            | 6.8                                       | 8.5                                       |                   |  |
| 98   | 10/29/2008 |   |   |  |  |                            | 15.8                                      | 17.1                                      |                   |  |
| 99   | 10/30/2008 |   |   |  |  |                            | 10.5                                      | 11.0                                      |                   |  |
| 100  | 10/31/2008 | 11.7                                    | 12.0                                    | 16.9                                   | 18.5                                   | 66.9                       | 9.5                                       | 10.2                                      |                   |  |
| 101  | 11/1/2008  | 14.8                                    | 15.1                                    | 18.3                                   | 19.2                                   | 79.9                       | 12.6                                      | 14.2                                      |                   |  |
| 102  | 11/2/2008  | 20.4                                    | 20.0                                    | 25.5                                   | 25.8                                   | 78.7                       | 18.0                                      | 20.0                                      |                   |  |
| 103  | 11/3/2008  | 20.7                                    | 20.9                                    | 27.0                                   | 27.8                                   | 76.0                       | 19.0                                      | 20.5                                      |                   |  |
| 104  | 11/4/2008  | 31.1                                    | 30.9                                    | 37.5                                   | 38.4                                   | 81.7                       | 29.5                                      | 31.6                                      |                   |  |
| 105  | 11/5/2008  | 29.7                                    | 29.6                                    | 35.5                                   | 36.2                                   | 82.8                       | 26.6                                      | 29.3                                      |                   |  |
| 106  | 11/6/2008  | 23.5                                    | 23.8                                    | 28.2                                   | 28.6                                   | 83.2                       | 21.2                                      | 23.6                                      |                   |  |
| 107  | 11/7/2008  | 6.8                                     | 6.7                                     | 15.2                                   | 14.7                                   | 45.4                       | 6.6                                       | 8.0                                       |                   |  |
| 108  | 11/8/2008  | 3.5                                     | 3.5                                     | 8.6                                    | 9.4                                    | 39.1                       | 3.7                                       | 4.1                                       |                   |  |
| 109  | 11/9/2008  | 4.1                                     | 4.0                                     | 11.5                                   | 11.9                                   | 34.8                       | 4.5                                       | 3.9                                       |                   |  |
| 110  | 12/4/2008  |   |   |  |  |                            | 6.2                                       | 8.4                                       |                   | Cologne, Winter  |
| 111  | 12/5/2008  | 9.1                                     | 9.2                                     | 12.5                                   | 13.0                                   | 71.6                       | 7.5                                       | 9.9                                       |                   |  |
| 112  | 12/6/2008  |   |   |  |  |                            | 13.8                                      | 18.0                                      |                   |  |
| 113  | 12/7/2008  | 17.4                                    | 17.2                                    | 22.6                                   | 22.8                                   | 76.1                       | 16.7                                      | 18.4                                      |                   |  |
| 114  | 12/8/2008  | 15.2                                    | 15.8                                    | 18.2                                   | 18.3                                   | 84.8                       | 14.1                                      | 16.7                                      |                   |  |
| 115  | 12/9/2008  | 22.7                                    | 22.2                                    |  |  |                            | 20.7                                      | 24.9                                      | Outlier Ref. PM10 |  |
| 116  | 12/10/2008 | 19.9                                    | 18.8                                    | 24.1                                   | 23.9                                   | 80.6                       | 18.8                                      | 20.4                                      |                   |  |
| 117  | 12/11/2008 | 24.0                                    | 24.0                                    | 28.3                                   | 29.3                                   | 83.2                       | 22.4                                      | 25.1                                      |                   |  |
| 118  | 12/12/2008 | 17.3                                    | 16.6                                    | 19.1                                   | 19.5                                   | 87.8                       | 15.5                                      | 18.1                                      |                   |  |
| 119  | 12/13/2008 | 17.9                                    | 18.5                                    |  |  |                            | 16.9                                      | 19.1                                      | Outlier Ref. PM10 |  |
| 120  | 12/14/2008 |   |   |  |  |                            | 36.6                                      | 42.1                                      |                   |  |

Addendum to the report on performance testing, report no. 936/21209919/A of 26 March 2010 for the BAM-1020 with PM2,5 pre-separator for suspended particulate matter PM2,5 manufactured by Met One Instruments, Inc., Report No.: 936/21243375/A

Annex 5

Measured values from field test sites, related to actual conditions

| Manufacturer Met One Instruments |            |                            |                            |                           |                           |                            |                              |                              |             | PM2,5                          |
|----------------------------------|------------|----------------------------|----------------------------|---------------------------|---------------------------|----------------------------|------------------------------|------------------------------|-------------|--------------------------------|
| Type of instrument BAM-1020      |            |                            |                            |                           |                           |                            |                              |                              |             | Measured values in µg/m³ (ACT) |
| Serial-No. SN 17010 / SN 17011   |            |                            |                            |                           |                           |                            |                              |                              |             |                                |
| No.                              | Date       | Ref. 1<br>PM2,5<br>[µg/m³] | Ref. 2<br>PM2,5<br>[µg/m³] | Ref. 1<br>PM10<br>[µg/m³] | Ref. 2<br>PM10<br>[µg/m³] | Ratio<br>PM2,5/PM10<br>[%] | SN 17010<br>PM2,5<br>[µg/m³] | SN 17011<br>PM2,5<br>[µg/m³] | Remark      | Test site                      |
| 121                              | 12/15/2008 | 31.3                       | 31.4                       | 34.9                      | 34.7                      | 90.1                       | 31.5                         | 32.5                         |             | Cologne, Winter                |
| 122                              | 12/16/2008 | 16.8                       | 16.4                       | 19.6                      | 20.4                      | 83.1                       | 17.6                         | 20.2                         |             |                                |
| 123                              | 12/17/2008 | 20.1                       | 20.1                       | 32.3                      | 33.2                      | 61.5                       | 22.5                         | 25.1                         |             |                                |
| 124                              | 12/18/2008 |                            |                            |                           |                           |                            | 12.1                         | 14.5                         |             |                                |
| 125                              | 12/19/2008 |                            |                            | 20.3                      | 21.6                      |                            | 10.5                         | 12.1                         |             |                                |
| 126                              | 12/20/2008 |                            |                            |                           |                           |                            | 7.4                          | 8.9                          |             |                                |
| 127                              | 12/21/2008 | 7.1                        | 8.5                        | 11.1                      | 11.1                      | 70.5                       | 8.6                          | 8.7                          |             |                                |
| 128                              | 12/22/2008 |                            |                            |                           |                           |                            | 15.4                         | 15.9                         |             |                                |
| 129                              | 12/23/2008 |                            |                            |                           |                           |                            | 21.2                         | 22.6                         |             |                                |
| 130                              | 12/24/2008 |                            |                            |                           |                           |                            | 24.1                         | 25.4                         |             |                                |
| 131                              | 12/25/2008 |                            |                            |                           |                           |                            | 8.2                          | 7.4                          |             |                                |
| 132                              | 12/26/2008 |                            |                            |                           |                           |                            | 12.0                         | 12.3                         |             |                                |
| 133                              | 12/27/2008 |                            |                            |                           |                           |                            | 19.7                         | 20.9                         |             |                                |
| 134                              | 12/28/2008 | 27.9                       | 27.9                       | 33.7                      | 33.9                      | 82.6                       | 27.0                         | 30.3                         |             |                                |
| 135                              | 12/29/2008 |                            |                            |                           |                           |                            | 33.5                         | 37.0                         |             |                                |
| 136                              | 12/30/2008 |                            |                            |                           |                           |                            | 45.7                         | 48.9                         |             |                                |
| 137                              | 12/31/2008 |                            |                            |                           |                           |                            | 98.2                         | 111.5                        |             |                                |
| 138                              | 1/1/2009   |                            |                            |                           |                           |                            | 82.0                         | 88.9                         |             |                                |
| 139                              | 1/2/2009   |                            |                            |                           |                           |                            | 46.3                         | 47.5                         |             |                                |
| 140                              | 1/3/2009   |                            |                            |                           |                           |                            | 32.9                         | 36.9                         |             |                                |
| 141                              | 1/4/2009   | 30.0                       | 30.4                       | 35.1                      | 36.7                      | 84.1                       | 28.7                         | 32.1                         |             |                                |
| 142                              | 1/5/2009   | 14.7                       | 15.4                       | 17.0                      | 16.3                      | 90.3                       | 14.1                         | 16.8                         |             |                                |
| 143                              | 1/6/2009   | 34.6                       | 34.8                       | 49.7                      | 48.6                      | 70.7                       | 39.4                         | 43.0                         |             |                                |
| 144                              | 1/7/2009   |                            |                            |                           |                           |                            |                              |                              | Zero filter |                                |
| 145                              | 1/8/2009   |                            |                            |                           |                           |                            | 35.5                         | 36.3                         |             |                                |
| 146                              | 1/9/2009   | 38.8                       | 38.6                       | 48.6                      | 47.7                      | 80.4                       | 37.0                         | 41.6                         |             |                                |
| 147                              | 1/10/2009  | 45.7                       | 44.6                       | 48.3                      | 48.8                      | 92.9                       | 39.9                         | 45.4                         |             |                                |
| 148                              | 1/11/2009  |                            |                            |                           |                           |                            | 41.9                         | 46.5                         |             |                                |
| 149                              | 1/12/2009  | 38.4                       | 38.4                       | 42.7                      | 42.9                      | 89.7                       | 36.0                         | 39.4                         |             |                                |
| 150                              | 1/13/2009  | 36.3                       | 36.0                       | 41.7                      | 41.6                      | 86.8                       | 34.3                         | 38.3                         |             |                                |

**Annex 5**

**Measured values from field test sites, related to actual conditions**

| <p><b>Manufacturer</b> Met One Instruments</p> <p><b>Type of instrument</b> BAM-1020</p> <p><b>Serial-No.</b> SN 17010 / SN 17011</p> <th colspan="2"> <p>PM2,5<br/>Measured values in µg/m³ (ACT)</p> </th> |           |                            |                            |                           |                           |                            |                              |                              |                    | <p>PM2,5<br/>Measured values in µg/m³ (ACT)</p> |  |
|--|-----------|----------------------------|----------------------------|---------------------------|---------------------------|----------------------------|------------------------------|------------------------------|--------------------|---|--|
| No.  | Date      | Ref. 1<br>PM2,5<br>[µg/m³] | Ref. 2<br>PM2,5<br>[µg/m³] | Ref. 1<br>PM10<br>[µg/m³] | Ref. 2<br>PM10<br>[µg/m³] | Ratio<br>PM2,5/PM10<br>[%] | SN 17010<br>PM2,5<br>[µg/m³] | SN 17011<br>PM2,5<br>[µg/m³] | Remark             | Test site                                       |  |
| 151  | 1/14/2009 | 31.1                       | 31.3                       | 38.2                      | 38.2                      | 81.5                       | 30.1                         | 33.7                         |                    | Cologne, Winter                                 |  |
| 152  | 1/15/2009 | 28.4                       | 28.5                       | 32.2                      | 32.0                      | 88.6                       | 27.9                         | 31.3                         |                    |   |  |
| 153  | 1/16/2009 | 36.6                       | 36.8                       | 39.9                      | 40.2                      | 91.6                       | 35.5                         | 39.3                         |                    |   |  |
| 154  | 1/17/2009 |                            |                            |                           |                           |                            | 16.8                         | 16.5                         |                    |   |  |
| 155  | 1/18/2009 | 5.0                        | 4.4                        | 8.5                       | 7.9                       | 57.3                       | 5.9                          | 6.1                          |                    |   |  |
| 156  | 1/19/2009 | 3.0                        | 3.3                        | 6.7                       | 5.9                       | 50.0                       | 5.0                          | 4.9                          |                    |   |  |
| 157  | 1/20/2009 |                            |                            | 14.2                      | 14.5                      |                            | 9.7                          | 11.0                         | Outlier Ref. PM2,5 |   |  |
| 158  | 1/21/2009 | 16.0                       | 16.0                       | 21.2                      | 21.6                      | 74.5                       | 16.3                         | 17.8                         |                    |   |  |
| 159  | 1/22/2009 | 6.2                        | 6.3                        | 9.0                       | 8.6                       | 71.3                       | 7.7                          | 7.2                          |                    |   |  |
| 160  | 1/23/2009 | 5.3                        | 4.9                        | 9.2                       | 9.1                       | 55.5                       | 7.2                          | 7.2                          |                    |   |  |
| 161  | 1/24/2009 |                            |                            |                           |                           |                            | 17.4                         | 18.7                         |                    |   |  |
| 162  | 1/25/2009 | 16.4                       | 16.6                       | 21.0                      | 20.4                      | 79.4                       | 16.4                         | 17.6                         |                    |   |  |
| 163  | 1/26/2009 | 35.1                       | 35.5                       | 44.8                      | 43.8                      | 79.6                       | 38.9                         | 39.9                         |                    |   |  |
| 164  | 1/27/2009 | 31.0                       | 31.2                       | 37.4                      | 37.5                      | 83.0                       | 33.6                         | 34.3                         |                    |   |  |
| 165  | 1/28/2009 | 29.9                       | 29.4                       | 33.5                      | 33.9                      | 87.9                       | 31.5                         | 31.7                         |                    |   |  |
| 166  | 1/29/2009 |                            |                            |                           |                           |                            | 28.4                         | 31.3                         |                    |   |  |
| 167  | 1/30/2009 | 23.6                       | 24.1                       | 29.5                      | 29.2                      | 81.2                       | 29.4                         | 26.6                         |                    |   |  |
| 168  | 1/31/2009 |                            |                            |                           |                           |                            | 7.1                          | 7.9                          |                    |   |  |
| 169  | 2/1/2009  | 15.2                       | 15.6                       | 17.8                      | 18.1                      | 85.9                       | 18.7                         | 18.3                         |                    |   |  |
| 170  | 2/2/2009  |                            |                            |                           |                           |                            |                              |                              | Zero filter        |   |  |
| 171  | 2/3/2009  |                            |                            | 41.3                      | 41.0                      |                            | 37.1                         | 39.4                         | Outlier Ref. PM2,5 |   |  |
| 172  | 2/4/2009  | 30.9                       | 30.2                       | 34.3                      | 34.2                      | 89.1                       | 33.0                         | 33.5                         |                    |   |  |
| 173  | 2/5/2009  | 17.6                       | 17.1                       | 21.2                      | 21.2                      | 81.9                       | 19.0                         | 19.1                         |                    |   |  |
| 174  | 2/6/2009  | 19.4                       | 19.8                       | 23.5                      | 23.7                      | 83.0                       | 22.5                         | 22.9                         |                    |   |  |
| 175  | 2/7/2009  |                            |                            |                           |                           |                            | 22.9                         | 22.5                         |                    |   |  |
| 176  | 2/8/2009  | 12.4                       | 12.6                       | 16.1                      | 16.1                      | 77.3                       | 15.2                         | 13.8                         |                    |   |  |
| 177  | 2/9/2009  | 7.1                        | 6.7                        | 10.8                      | 10.4                      | 64.9                       | 8.6                          | 7.1                          |                    |   |  |
| 178  | 2/10/2009 |                            |                            |                           |                           |                            | 8.3                          | 8.2                          |                    |   |  |
| 179  | 2/11/2009 | 11.5                       | 11.9                       | 16.8                      | 16.6                      | 70.1                       | 13.9                         | 12.7                         |                    |   |  |
| 180  | 2/12/2009 | 12.2                       | 13.1                       | 21.8                      | 22.7                      | 57.0                       | 16.9                         | 16.4                         |                    |   |  |

Addendum to the report on performance testing, report no. 936/21209919/A of 26 March 2010 for the BAM-1020 with PM2,5 pre-separator for suspended particulate matter PM2,5 manufactured by Met One Instruments, Inc., Report No.: 936/21243375/A

Page 129 of 160

Annex 5

Measured values from field test sites, related to actual conditions

Page 7 of 13

| Manufacturer Met One Instruments |           |                            |                            |                           |                           |                            |                              |                              |                              | PM2,5                          |
|----------------------------------|-----------|----------------------------|----------------------------|---------------------------|---------------------------|----------------------------|------------------------------|------------------------------|------------------------------|--------------------------------|
| Type of instrument BAM-1020      |           |                            |                            |                           |                           |                            |                              |                              |                              | Measured values in µg/m³ (ACT) |
| Serial-No. SN 17010 / SN 17011   |           |                            |                            |                           |                           |                            |                              |                              |                              |                                |
| No.                              | Date      | Ref. 1<br>PM2,5<br>[µg/m³] | Ref. 2<br>PM2,5<br>[µg/m³] | Ref. 1<br>PM10<br>[µg/m³] | Ref. 2<br>PM10<br>[µg/m³] | Ratio<br>PM2,5/PM10<br>[%] | SN 17010<br>PM2,5<br>[µg/m³] | SN 17011<br>PM2,5<br>[µg/m³] | Remark                       | Test site                      |
| 181                              | 2/13/2009 | 19.8                       | 19.6                       | 25.9                      | 26.3                      | 75.4                       | 23.6                         | 22.2                         | Ref. 2 PM2,5 not operational | Cologne, Winter                |
| 182                              | 2/14/2009 |                            |                            |                           |                           |                            | 28.9                         | 28.7                         |                              |                                |
| 183                              | 2/15/2009 | 19.5                       | 19.9                       | 24.7                      | 25.1                      | 79.0                       | 24.8                         | 22.2                         |                              |                                |
| 184                              | 2/16/2009 |                            |                            | 17.7                      | 18.2                      |                            | 15.8                         | 16.3                         |                              |                                |
| 185                              | 2/17/2009 | 10.7                       | 10.5                       | 12.7                      | 13.1                      | 82.0                       | 10.3                         | 11.0                         |                              |                                |
| 186                              | 2/18/2009 | 15.0                       | 14.5                       | 21.0                      | 21.6                      | 69.2                       | 14.9                         | 16.2                         |                              |                                |
| 187                              | 2/19/2009 | 30.9                       | 31.0                       | 38.8                      | 38.8                      | 79.7                       | 30.2                         | 31.7                         |                              |                                |
| 188                              | 2/20/2009 | 12.9                       | 13.1                       | 18.3                      | 18.3                      | 70.8                       | 14.7                         | 16.0                         |                              |                                |
| 189                              | 2/21/2009 |                            |                            |                           |                           |                            | 23.1                         | 24.7                         |                              |                                |
| 190                              | 2/22/2009 | 13.5                       | 13.9                       | 20.2                      | 20.8                      | 66.7                       | 15.0                         | 14.0                         |                              |                                |
| 191                              | 2/23/2009 | 6.6                        | 6.0                        | 14.6                      | 15.0                      | 42.4                       | 6.6                          | 8.5                          |                              |                                |
| 192                              | 2/24/2009 | 19.1                       | 18.9                       | 29.9                      | 30.5                      | 63.0                       | 20.3                         | 21.9                         |                              |                                |
| 193                              | 2/25/2009 | 26.9                       | 27.3                       | 36.3                      | 35.5                      | 75.4                       | 28.6                         | 28.4                         |                              |                                |
| 194                              | 2/26/2009 | 20.0                       | 19.6                       | 30.7                      | 30.7                      | 64.6                       | 19.8                         | 20.4                         |                              |                                |
| 195                              | 2/27/2009 | 21.1                       | 21.2                       | 28.3                      | 28.2                      | 74.9                       | 24.0                         | 22.4                         |                              |                                |
| 196                              | 2/28/2009 | 25.0                       | 25.0                       | 31.4                      | 31.5                      | 79.6                       | 26.5                         | 27.1                         |                              |                                |
| 197                              | 3/1/2009  |                            |                            |                           |                           |                            | 31.5                         | 33.1                         |                              |                                |
| 198                              | 3/2/2009  | 28.0                       | 27.8                       | 36.9                      | 37.1                      | 75.3                       | 28.0                         | 28.7                         |                              |                                |
| 199                              | 3/3/2009  | 20.8                       | 21.2                       | 25.9                      | 25.7                      | 81.4                       | 19.6                         | 21.4                         |                              |                                |
| 200                              | 3/4/2009  |                            |                            |                           |                           |                            |                              |                              | Zero filter                  |                                |
| 201                              | 3/5/2009  | 15.2                       | 13.7                       | 15.2                      | 16.0                      | 92.8                       | 14.7                         | 14.9                         |                              |                                |
| 202                              | 3/6/2009  | 16.1                       | 14.8                       | 21.4                      | 21.9                      | 71.6                       | 16.0                         | 17.9                         |                              |                                |
| 203                              | 3/7/2009  | 18.7                       | 18.9                       | 26.1                      | 26.1                      | 71.9                       | 18.7                         | 16.9                         |                              |                                |
| 204                              | 3/8/2009  |                            |                            |                           |                           |                            | 5.6                          | 6.9                          |                              |                                |
| 205                              | 3/9/2009  |                            |                            |                           |                           |                            | 8.0                          | 9.2                          |                              |                                |
| 206                              | 3/10/2009 |                            |                            |                           |                           |                            | 8.3                          | 9.7                          |                              |                                |
| 207                              | 3/11/2009 | 13.0                       | 13.2                       | 21.4                      | 21.6                      | 60.7                       | 13.9                         | 14.2                         |                              |                                |
| 208                              | 3/12/2009 | 19.1                       | 19.2                       | 24.1                      | 24.5                      | 78.8                       | 19.5                         | 21.5                         |                              |                                |
| 209                              | 3/13/2009 | 16.3                       | 16.9                       | 28.8                      | 28.2                      | 58.4                       | 17.1                         | 17.1                         |                              |                                |
| 210                              | 3/14/2009 | 17.2                       | 17.6                       | 25.7                      | 26.3                      | 66.9                       | 17.4                         | 18.2                         |                              |                                |

**Annex 5**

**Measured values from field test sites, related to actual conditions**

| <b>Manufacturer</b> Met One Instruments<br><b>Type of instrument</b> BAM-1020<br><b>Serial-No.</b> SN 17010 / SN 17011 |           |   |   |  |  |                            |   |   |             | <b>PM2,5</b><br>Measured values in µg/m <sup>3</sup> (ACT) |
|--|-----------|---|---|--|--|----------------------------|---|---|-------------|--|
| No.  | Date      | Ref. 1<br>PM2,5<br>[µg/m <sup>3</sup> ] | Ref. 2<br>PM2,5<br>[µg/m <sup>3</sup> ] | Ref. 1<br>PM10<br>[µg/m <sup>3</sup> ] | Ref. 2<br>PM10<br>[µg/m <sup>3</sup> ] | Ratio<br>PM2,5/PM10<br>[%] | SN 17010<br>PM2,5<br>[µg/m <sup>3</sup> ] | SN 17011<br>PM2,5<br>[µg/m <sup>3</sup> ] | Remark      | Test site  |
| 211  | 3/15/2009 |   |   |  |  |                            | 8.6                                       | 10.5                                      |             | Cologne, Winter  |
| 212  | 3/16/2009 | 26.4                                    | 26.4                                    | 37.0                                   | 37.5                                   | 70.9                       | 28.9                                      | 30.8                                      |             |  |
| 213  | 3/17/2009 | 24.5                                    | 24.9                                    | 36.8                                   | 36.7                                   | 67.4                       | 24.0                                      | 23.3                                      |             |  |
| 214  | 3/18/2009 | 23.2                                    | 23.8                                    | 38.1                                   | 38.6                                   | 61.3                       | 22.6                                      | 22.2                                      |             |  |
| 215  | 3/19/2009 | 17.3                                    | 17.9                                    | 28.5                                   | 29.2                                   | 61.0                       | 15.4                                      | 15.3                                      |             |  |
| 216  | 3/20/2009 | 16.0                                    | 14.1                                    | 26.1                                   | 27.0                                   | 56.7                       | 13.8                                      | 15.8                                      |             |  |
| 217  | 3/21/2009 |   |   |  |  |                            | 43.5                                      | 45.4                                      |             |  |
| 218  | 3/22/2009 | 19.0                                    | 18.5                                    | 32.7                                   | 32.1                                   | 57.8                       | 20.1                                      | 19.2                                      |             |  |
| 219  | 3/23/2009 | 9.9                                     | 10.1                                    | 20.8                                   | 20.4                                   | 48.6                       | 10.2                                      | 10.4                                      |             |  |
| 220  | 3/24/2009 | 8.5                                     | 8.9                                     | 15.7                                   | 16.0                                   | 54.8                       | 8.0                                       | 8.7                                       |             |  |
| 221  | 3/25/2009 | 9.2                                     | 8.8                                     | 14.0                                   | 14.4                                   | 63.2                       | 10.1                                      | 11.4                                      |             |  |
| 222  | 3/26/2009 | 7.2                                     | 7.8                                     | 10.9                                   | 11.5                                   | 67.0                       | 8.2                                       | 7.1                                       |             |  |
| 223  | 3/27/2009 | 8.4                                     | 8.4                                     | 12.9                                   | 12.3                                   | 67.0                       | 8.5                                       | 8.4                                       |             |  |
| 224  | 3/28/2009 | 7.3                                     | 6.5                                     | 9.3                                    | 8.9                                    | 75.6                       | 5.7                                       | 8.4                                       |             |  |
| 225  | 3/29/2009 |   |   |  |  |                            | 14.2                                      | 17.5                                      |             |  |
| 226  | 3/30/2009 |   |   |  |  |                            | 24.2                                      | 24.7                                      |             |  |
| 227  | 3/31/2009 |   |   |  |  |                            | 24.1                                      | 25.9                                      |             |  |
| 228  | 4/1/2009  |   |   |  |  |                            | 25.7                                      | 26.2                                      |             |  |
| 229  | 4/2/2009  |   |   |  |  |                            |   |   | Zero filter |  |
| 230  | 4/3/2009  |   |   |  |  |                            | 63.6                                      | 66.4                                      |             |  |
| 231  | 4/4/2009  |   |   |  |  |                            | 90.4                                      | 92.0                                      |             |  |
| 232  | 4/5/2009  |   |   |  |  |                            | 78.4                                      | 77.4                                      |             |  |
| 233  | 4/6/2009  |   |   |  |  |                            | 31.7                                      | 29.9                                      |             |  |
| 234  | 4/7/2009  |   |   |  |  |                            | 22.2                                      | 21.4                                      |             |  |
| 235  | 4/8/2009  |   |   |  |  |                            | 7.0                                       | 4.8                                       |             |  |
| 236  | 4/9/2009  |   |   |  |  |                            | 9.2                                       | 8.3                                       |             |  |
| 237  | 4/10/2009 |   |   |  |  |                            | 17.3                                      | 17.4                                      |             |  |
| 238  | 4/11/2009 |   |   |  |  |                            | 35.5                                      | 38.5                                      |             |  |
| 239  | 4/12/2009 |   |   |  |  |                            | 124.1                                     | 126.7                                     |             |  |
| 240  | 4/13/2009 |   |   |  |  |                            | 110.7                                     | 105.1                                     |             |  |

Addendum to the report on performance testing, report no. 936/21209919/A of 26 March 2010 for the BAM-1020 with PM2,5 pre-separator for suspended particulate matter PM2,5 manufactured by Met One Instruments, Inc., Report No.: 936/21243375/A

**Annex 5** **Measured values from field test sites, related to actual conditions** **Page 9 of 13**

| Manufacturer Met One Instruments<br>Type of instrument BAM-1020<br>Serial-No. SN 17010 / SN 17011 |           |                            |                            |                           |                           |                            |                              |   |   | PM2,5<br>Measured values in µg/m³ (ACT) |
|---|-----------|----------------------------|----------------------------|---------------------------|---------------------------|----------------------------|------------------------------|---|---|---|
| No.   | Date      | Ref. 1<br>PM2,5<br>[µg/m³] | Ref. 2<br>PM2,5<br>[µg/m³] | Ref. 1<br>PM10<br>[µg/m³] | Ref. 2<br>PM10<br>[µg/m³] | Ratio<br>PM2,5/PM10<br>[%] | SN 17010<br>PM2,5<br>[µg/m³] | SN 17011<br>PM2,5<br>[µg/m³]                            | Remark  | Test site                               |
| 241   | 8/9/2009  | 38.1                       | 37.7                       |                           |                           |                            |                              | 40.5  | 17010 shows peaks in measured values and stability values | Bornheim, Summer                        |
| 242   | 8/10/2009 |                            |                            |                           |                           |                            | 29.4                         |   |   |   |
| 243   | 8/11/2009 | 12.4                       | 11.9                       |                           |                           |                            | 10.6                         | Exchange of PMT for 17010<br>Zero filter<br>Zero filter |   |   |
| 244   | 8/12/2009 | 9.6                        | 10.0                       |                           |                           |                            |                              |   |   |   |
| 245   | 8/13/2009 |                            |                            |                           |                           |                            |                              |   |   |   |
| 246   | 8/14/2009 |                            |                            |                           |                           |                            |                              |   |   |   |
| 247   | 8/15/2009 |                            |                            |                           |                           |                            | 11.5                         | 10.7  |   |   |
| 248   | 8/16/2009 | 16.5                       | 16.7                       | 22.8                      | 22.8                      | 72.8                       | 15.0                         | 13.9  |   |   |
| 249   | 8/17/2009 | 15.0                       | 15.0                       | 24.1                      | 23.7                      | 62.7                       | 15.7                         | 14.1  |   |   |
| 250   | 8/18/2009 | 12.4                       | 13.0                       | 20.1                      | 19.7                      | 63.7                       | 13.3                         | 13.3  |   |   |
| 251   | 8/19/2009 | 16.8                       | 17.2                       | 24.0                      | 24.3                      | 70.3                       | 15.0                         | 13.7  |   |   |
| 252   | 8/20/2009 | 19.6                       | 19.4                       | 33.4                      | 32.7                      | 59.1                       | 14.4                         | 11.6  |   |   |
| 253   | 8/21/2009 | 8.0                        | 8.2                        | 18.9                      | 18.7                      | 43.0                       | 9.7                          | 8.1   |   |   |
| 254   | 8/22/2009 |                            |                            |                           |                           |                            | 10.8                         | 9.6   |   |   |
| 255   | 8/23/2009 | 11.7                       | 12.0                       | 17.2                      | 17.6                      | 68.1                       | 10.7                         | 9.1   |   |   |
| 256   | 8/24/2009 | 14.3                       | 13.8                       | 19.1                      | 20.4                      | 71.3                       | 12.0                         | 11.3  |   |   |
| 257   | 8/25/2009 |                            |                            | 21.4                      | 21.2                      |                            | 15.9                         | 12.9  | Outlier Ref. PM2,5  |   |
| 258   | 8/26/2009 |                            |                            |                           |                           |                            | 9.2                          | 7.6   |   |   |
| 259   | 8/27/2009 | 8.7                        | 9.1                        | 15.4                      | 16.1                      | 56.3                       | 6.6                          | 4.8   |   |   |
| 260   | 8/28/2009 | 8.3                        | 8.0                        | 17.0                      | 16.9                      | 48.1                       | 7.0                          | 4.6   |   |   |
| 261   | 8/29/2009 |                            |                            |                           |                           |                            | 7.5                          | 6.0   |   |   |
| 262   | 8/30/2009 | 7.3                        | 7.5                        | 16.8                      | 16.8                      | 43.9                       | 7.8                          | 6.3   |   |   |
| 263   | 8/31/2009 | 12.3                       | 11.9                       | 22.3                      | 21.0                      | 55.9                       | 9.1                          | 8.2   |   |   |
| 264   | 9/1/2009  | 11.3                       | 11.3                       | 18.1                      | 18.4                      | 62.0                       | 9.9                          | 8.6   |   |   |
| 265   | 9/2/2009  | 7.9                        | 8.0                        | 13.3                      | 13.7                      | 58.9                       |                              | 6.8   | SN 17010, Filter tape cut<br>SN 17010, Filter tape cut    |   |
| 266   | 9/3/2009  | 5.3                        | 5.3                        | 8.0                       | 7.2                       | 69.1                       |                              | 4.4   |   |   |
| 267   | 9/4/2009  | 5.4                        | 5.4                        | 8.9                       | 9.2                       | 60.0                       | 4.5                          | 5.6   |   |   |
| 268   | 9/5/2009  |                            |                            |                           |                           |                            | 7.9                          | 7.2   |   |   |
| 269   | 9/6/2009  | 6.7                        | 6.5                        | 10.6                      | 10.6                      | 62.3                       | 6.9                          | 7.7   |   |   |
| 270   | 9/7/2009  | 11.4                       | 11.9                       | 18.5                      | 18.5                      | 62.8                       | 10.5                         | 11.5  |   |   |



**Annex 5** **Measured values from field test sites, related to actual conditions** **Page 10 of 13**

| Manufacturer Met One Instruments<br>Type of instrument BAM-1020<br>Serial-No. SN 17010 / SN 17011 |           |                            |                            |                           |                           |                            |                              |                              |             | PM2,5<br>Measured values in µg/m³ (ACT) |
|---|-----------|----------------------------|----------------------------|---------------------------|---------------------------|----------------------------|------------------------------|------------------------------|-------------|---|
| No.   | Date      | Ref. 1<br>PM2,5<br>[µg/m³] | Ref. 2<br>PM2,5<br>[µg/m³] | Ref. 1<br>PM10<br>[µg/m³] | Ref. 2<br>PM10<br>[µg/m³] | Ratio<br>PM2,5/PM10<br>[%] | SN 17010<br>PM2,5<br>[µg/m³] | SN 17011<br>PM2,5<br>[µg/m³] | Remark      | Test site                               |
| 271   | 9/8/2009  | 17.0                       | 16.9                       | 25.2                      | 25.0                      | 67.5                       | 15.2                         | 16.5                         | Zero filter | Bornheim, Summer                        |
| 272   | 9/9/2009  | 19.4                       | 19.2                       | 38.2                      | 37.5                      | 51.0                       | 20.0                         | 20.1                         |             |   |
| 273   | 9/10/2009 | 10.2                       | 9.6                        | 22.3                      | 21.9                      | 44.7                       | 12.4                         | 14.8                         |             |   |
| 274   | 9/11/2009 | 9.1                        | 9.4                        | 21.0                      | 20.7                      | 44.4                       | 9.2                          | 11.6                         |             |   |
| 275   | 9/12/2009 |                            |                            |                           |                           |                            | 11.4                         | 11.6                         |             |   |
| 276   | 9/13/2009 | 5.4                        | 5.6                        | 12.9                      | 13.8                      | 41.5                       | 6.3                          | 6.2                          |             |   |
| 277   | 9/14/2009 |                            |                            |                           |                           |                            |                              |                              |             |   |
| 278   | 9/15/2009 | 12.6                       | 13.0                       | 17.2                      | 16.8                      | 75.0                       | 15.0                         | 16.2                         |             |   |
| 279   | 9/16/2009 | 25.6                       | 25.9                       | 34.5                      | 33.3                      | 76.0                       | 27.2                         | 30.8                         |             |   |
| 280   | 9/17/2009 | 13.6                       | 13.8                       | 20.8                      | 20.2                      | 66.8                       | 14.3                         | 17.2                         |             |   |
| 281   | 9/18/2009 | 18.7                       | 19.0                       | 24.8                      | 25.6                      | 74.8                       | 19.7                         | 19.9                         |             |   |
| 282   | 9/19/2009 |                            |                            |                           |                           |                            | 23.1                         | 24.7                         |             |   |
| 283   | 9/20/2009 | 36.7                       | 37.1                       | 45.0                      | 45.2                      | 81.8                       | 39.6                         | 41.3                         |             |   |
| 284   | 9/21/2009 | 18.2                       | 19.0                       | 28.7                      | 29.1                      | 64.3                       | 23.0                         | 25.3                         |             |   |
| 285   | 9/22/2009 | 14.9                       | 15.0                       | 27.2                      | 28.1                      | 54.1                       | 17.2                         | 17.9                         |             |   |
| 286   | 9/23/2009 | 12.9                       | 12.7                       | 26.8                      | 27.0                      | 47.5                       | 13.2                         | 16.4                         |             |   |
| 287   | 9/24/2009 | 14.9                       | 14.5                       | 23.0                      | 22.8                      | 64.0                       | 14.7                         | 16.7                         |             |   |
| 288   | 9/25/2009 | 16.3                       | 16.1                       | 28.6                      | 27.4                      | 57.9                       | 15.6                         | 16.9                         |             |   |
| 289   | 9/26/2009 |                            |                            |                           |                           |                            | 14.8                         | 15.3                         |             |   |
| 290   | 9/27/2009 | 26.0                       | 25.7                       | 34.9                      | 35.8                      | 73.0                       | 24.0                         | 24.3                         |             |   |
| 291   | 9/28/2009 | 28.8                       | 29.5                       | 44.4                      | 45.3                      | 65.1                       | 29.0                         | 30.8                         |             |   |
| 292   | 9/29/2009 | 18.0                       | 18.3                       | 28.0                      | 27.8                      | 65.1                       | 18.5                         | 20.0                         |             |   |
| 293   | 9/30/2009 | 19.1                       | 19.7                       | 25.1                      | 25.3                      | 77.2                       | 19.2                         | 21.1                         |             |   |
| 294   | 10/1/2009 | 9.6                        | 8.9                        | 18.5                      | 18.8                      | 49.5                       | 9.7                          | 9.8                          |             |   |
| 295   | 10/2/2009 | 12.0                       | 12.0                       | 25.9                      | 26.1                      | 46.0                       | 10.3                         | 11.1                         |             |   |
| 296   | 10/3/2009 |                            |                            |                           |                           |                            | 5.9                          | 7.7                          |             |   |
| 297   | 10/4/2009 | 5.4                        | 6.0                        | 10.6                      | 11.0                      | 52.6                       | 5.5                          | 4.3                          |             |   |
| 298   | 10/5/2009 | 8.2                        | 8.4                        | 12.5                      | 14.0                      | 62.7                       | 7.4                          | 9.3                          |             |   |
| 299   | 10/6/2009 | 12.8                       | 12.9                       | 17.5                      | 18.8                      | 70.7                       | 13.1                         | 13.9                         |             |   |
| 300   | 10/7/2009 | 8.7                        | 8.5                        | 14.0                      | 14.3                      | 60.9                       | 9.1                          | 8.7                          |             |   |

Addendum to the report on performance testing, report no. 936/21209919/A of 26 March 2010 for the BAM-1020 with PM2,5 pre-separator for suspended particulate matter PM2,5 manufactured by Met One Instruments, Inc., Report No.: 936/21243375/A

**Annex 5** **Measured values from field test sites, related to actual conditions** **Page 11 of 13**

| Manufacturer Met One Instruments<br>Type of instrument BAM-1020<br>Serial-No. SN 17010 / SN 17011 |            |                            |                            |                           |                           |                            |                              |                              |  | PM2,5<br>Measured values in µg/m³ (ACT) |  |
|---|------------|----------------------------|----------------------------|---------------------------|---------------------------|----------------------------|------------------------------|------------------------------|--|---|--|
| No.   | Date       | Ref. 1<br>PM2,5<br>[µg/m³] | Ref. 2<br>PM2,5<br>[µg/m³] | Ref. 1<br>PM10<br>[µg/m³] | Ref. 2<br>PM10<br>[µg/m³] | Ratio<br>PM2,5/PM10<br>[%] | SN 17010<br>PM2,5<br>[µg/m³] | SN 17011<br>PM2,5<br>[µg/m³] | Remark   | Test site                               |  |
| 301   | 10/8/2009  | 11.2                       | 10.7                       | 16.1                      | 16.7                      | 66.9                       | 12.9                         | 12.8                         |  | Bornheim, Summer                        |  |
| 302   | 10/9/2009  | 9.1                        | 8.5                        | 15.6                      | 15.6                      | 56.4                       | 8.1                          | 9.3                          |  |   |  |
| 303   | 10/10/2009 |                            |                            |                           |                           |                            | 10.0                         | 10.1                         |  |   |  |
| 304   | 10/11/2009 | 5.8                        | 6.6                        | 11.6                      | 12.0                      | 52.4                       | 5.1                          | 8.0                          |  |   |  |
| 305   | 10/12/2009 | 4.8                        | 4.2                        | 9.9                       | 9.9                       | 45.4                       | 5.0                          | 6.6                          |  |   |  |
| 306   | 10/13/2009 | 6.2                        | 6.3                        | 12.5                      | 12.5                      | 50.0                       | 6.5                          | 6.8                          |  |   |  |
| 307   | 10/14/2009 | 11.2                       | 10.3                       | 15.4                      | 15.6                      | 69.6                       | 10.1                         | 11.8                         |  |   |  |
| 308   | 10/15/2009 | 11.2                       | 10.2                       | 18.0                      | 17.8                      | 59.8                       | 8.9                          | 10.7                         |  |   |  |
| 309   | 10/16/2009 | 6.5                        | 6.3                        | 16.1                      | 15.8                      | 40.3                       | 5.7                          | 8.5                          |  |   |  |
| 310   | 10/17/2009 |                            |                            |                           |                           |                            | 8.4                          | 8.5                          |  |   |  |
| 311   | 10/18/2009 | 11.3                       | 11.3                       | 18.4                      | 18.6                      | 60.9                       | 10.4                         | 10.4                         |  |   |  |
| 312   | 10/19/2009 | 12.8                       | 12.8                       | 19.6                      | 19.6                      | 65.1                       | 11.9                         | 12.5                         |  |   |  |
| 313   | 10/20/2009 | 15.6                       | 14.9                       |                           |                           |                            | 13.0                         | 14.2                         | Outlier Ref. PM10  |   |  |
| 314   | 10/21/2009 | 20.8                       | 21.2                       | 27.6                      | 28.1                      | 75.6                       | 18.4                         | 19.7                         |  |   |  |
| 315   | 10/22/2009 |                            |                            | 31.7                      | 32.3                      |                            | 23.3                         | 25.0                         | Outlier Ref. PM2,5                                       |   |  |
| 316   | 12/9/2009  | 11.3                       | 11.6                       | 27.5                      | 27.5                      | 41.6                       | 10.1                         | 10.5                         |  | Teddington, Winter                      |  |
| 317   | 12/10/2009 | 16.4                       | 16.2                       | 25.4                      | 25.4                      | 64.2                       | 16.1                         | 17.4                         |  |   |  |
| 318   | 12/11/2009 | 11.8                       | 11.7                       | 20.3                      | 20.2                      | 57.9                       | 10.4                         | 11.4                         |  |   |  |
| 319   | 12/12/2009 | 6.4                        | 6.5                        | 13.5                      | 13.6                      | 47.6                       | 6.2                          | 6.9                          |  |   |  |
| 320   | 12/13/2009 | 8.6                        | 9.1                        | 13.4                      | 13.9                      | 65.1                       | 8.4                          | 8.3                          |  |   |  |
| 321   | 12/14/2009 | 27.9                       | 28.3                       | 35.3                      | 35.3                      | 79.6                       | 26.9                         | 27.4                         |  |   |  |
| 322   | 12/15/2009 | 39.8                       | 38.8                       | 47.6                      | 47.4                      | 82.8                       | 39.9                         |                              |  |   |  |
| 323   | 12/16/2009 | 24.9                       | 24.5                       | 30.0                      | 30.3                      | 82.0                       | 24.0                         |                              | SN 17011 Filter tape error<br>SN 17011 Filter tape error |   |  |
| 324   | 12/17/2009 | 5.7                        | 5.6                        | 10.2                      | 10.1                      | 55.7                       | 6.3                          | 6.4                          |  |   |  |
| 325   | 12/18/2009 | 11.6                       | 11.9                       | 16.9                      | 17.0                      | 69.3                       | 10.1                         | 11.3                         |  |   |  |
| 326   | 12/19/2009 | 10.3                       | 11.0                       | 15.4                      | 14.9                      | 70.4                       | 11.3                         | 12.0                         |  |   |  |
| 327   | 12/20/2009 | 6.2                        | 6.4                        | 11.1                      | 11.0                      | 56.9                       | 6.6                          | 7.9                          |  |   |  |
| 328   | 12/21/2009 | 17.7                       | 17.7                       | 20.2                      | 20.4                      | 87.2                       | 17.6                         | 17.9                         |  |   |  |
| 329   | 12/22/2009 | 29.4                       | 28.9                       |                           |                           |                            | 31.7                         | 31.9                         | Outlier Ref. PM10  |   |  |
| 330   | 12/23/2009 |                            |                            |                           |                           |                            | 14.7                         | 15.9                         |  |   |  |

Addendum to the report on performance testing, report no. 936/21209919/A of 26 March 2010 for the BAM-1020 with PM<sub>2,5</sub> pre-separator for suspended particulate matter PM<sub>2,5</sub> manufactured by Met One Instruments, Inc., Report No. 936/21243375/A

Addendum to the report on performance testing, report no. 936/21209919/A of 26 March 2010 for the BAM-1020 with PM2,5 pre-separator for suspended particulate matter PM2,5 manufactured by Met One Instruments, Inc., Report No.: 936/21243375/A

**Annex 5** **Measured values from field test sites, related to actual conditions** **Page 12 of 13**

| Manufacturer Met One Instruments<br>Type of instrument BAM-1020<br>Serial-No. SN 17010 / SN 17011 |            |                            |                            |                           |                           |                            |                              |                              |                    | PM2,5<br>Measured values in µg/m³ (ACT) |
|---|------------|----------------------------|----------------------------|---------------------------|---------------------------|----------------------------|------------------------------|------------------------------|--------------------|---|
| No.   | Date       | Ref. 1<br>PM2,5<br>[µg/m³] | Ref. 2<br>PM2,5<br>[µg/m³] | Ref. 1<br>PM10<br>[µg/m³] | Ref. 2<br>PM10<br>[µg/m³] | Ratio<br>PM2,5/PM10<br>[%] | SN 17010<br>PM2,5<br>[µg/m³] | SN 17011<br>PM2,5<br>[µg/m³] | Remark             | Test site                               |
| 331   | 12/24/2009 |                            |                            |                           |                           |                            | 16.5                         | 17.5                         |                    | Teddington, Winter                      |
| 332   | 12/25/2009 |                            |                            |                           |                           |                            | 9.5                          | 9.7                          |                    |   |
| 333   | 12/26/2009 |                            |                            |                           |                           |                            | 3.3                          | 3.2                          |                    |   |
| 334   | 12/27/2009 |                            |                            |                           |                           |                            | 4.6                          | 5.7                          |                    |   |
| 335   | 12/28/2009 |                            |                            |                           |                           |                            | 17.8                         | 19.2                         |                    |   |
| 336   | 12/29/2009 |                            |                            |                           |                           |                            | 8.7                          | 9.9                          |                    |   |
| 337   | 12/30/2009 |                            |                            |                           |                           |                            | 8.8                          | 9.3                          |                    |   |
| 338   | 12/31/2009 | 6.0                        | 6.5                        |                           |                           |                            | 6.5                          | 6.7                          |                    |   |
| 339   | 1/1/2010   |                            |                            |                           |                           |                            | 13.8                         | 13.7                         |                    |   |
| 340   | 1/2/2010   |                            |                            |                           |                           |                            | 11.6                         | 12.5                         |                    |   |
| 341   | 1/3/2010   |                            |                            |                           |                           |                            | 16.4                         | 17.7                         |                    |   |
| 342   | 1/4/2010   |                            |                            |                           |                           |                            |                              |                              | Zero filter        |   |
| 343   | 1/5/2010   | 15.6                       | 15.5                       |                           |                           |                            | 15.5                         | 16.4                         |                    |   |
| 344   | 1/6/2010   |                            |                            | 19.2                      | 19.3                      |                            | 13.0                         | 13.9                         | Outlier Ref. PM2,5 |   |
| 345   | 1/7/2010   | 15.3                       | 15.7                       | 19.4                      | 20.1                      | 78.4                       | 14.6                         | 15.7                         |                    |   |
| 346   | 1/8/2010   | 14.6                       | 14.9                       | 18.3                      | 18.4                      | 80.3                       | 12.9                         | 15.2                         |                    |   |
| 347   | 1/9/2010   | 7.1                        | 6.9                        | 14.6                      | 14.9                      | 47.4                       | 8.0                          | 7.9                          |                    |   |
| 348   | 1/10/2010  | 16.0                       | 16.1                       | 19.5                      | 19.2                      | 82.9                       | 14.4                         | 15.1                         |                    |   |
| 349   | 1/11/2010  | 45.7                       | 46.2                       | 51.8                      | 51.3                      | 89.1                       | 43.9                         | 45.3                         |                    |   |
| 350   | 1/12/2010  | 43.2                       | 43.6                       | 48.1                      | 48.0                      | 90.4                       | 43.0                         | 45.2                         |                    |   |
| 351   | 1/13/2010  | 48.0                       | 48.3                       | 53.4                      | 53.0                      | 90.6                       | 46.8                         | 47.9                         |                    |   |
| 352   | 1/14/2010  | 14.1                       | 14.4                       | 16.2                      | 16.3                      | 87.5                       | 14.6                         | 15.6                         |                    |   |
| 353   | 1/15/2010  | 14.6                       | 14.4                       | 26.9                      | 27.1                      | 53.6                       | 11.9                         | 13.2                         |                    |   |
| 354   | 1/16/2010  | 6.5                        | 6.1                        | 13.5                      | 13.6                      | 46.1                       | 7.5                          | 8.1                          |                    |   |
| 355   | 1/17/2010  | 11.0                       | 10.5                       | 20.6                      | 20.6                      | 52.3                       | 10.0                         | 10.4                         |                    |   |
| 356   | 1/18/2010  | 21.0                       | 20.4                       | 27.1                      | 26.9                      | 76.7                       | 18.5                         | 21.0                         |                    |   |
| 357   | 1/19/2010  | 20.4                       | 20.2                       | 26.5                      | 26.6                      | 76.4                       | 17.7                         | 19.6                         |                    |   |
| 358   | 1/20/2010  | 26.6                       | 27.0                       | 32.0                      | 31.9                      | 83.8                       | 25.1                         | 25.8                         |                    |   |
| 359   | 1/21/2010  | 20.5                       | 20.9                       | 27.5                      | 27.9                      | 75.0                       | 20.0                         | 20.0                         |                    |   |
| 360   | 1/22/2010  | 7.8                        | 7.6                        | 9.7                       | 9.8                       | 78.5                       | 7.3                          | 8.2                          |                    |   |

**Annex 5** **Measured values from field test sites, related to actual conditions** **Page 13 of 13**

| <b>Manufacturer</b> Met One Instruments |           |                            |                            |                           |                           |                            |                              |                              | PM2,5                          |                    |  |
|---|-----------|----------------------------|----------------------------|---------------------------|---------------------------|----------------------------|------------------------------|------------------------------|--------------------------------|--------------------|--|
| <b>Type of instrument</b> BAM-1020      |           |                            |                            |                           |                           |                            |                              |                              | Measured values in µg/m³ (ACT) |                    |  |
| <b>Serial-No.</b> SN 17010 / SN 17011   |           |                            |                            |                           |                           |                            |                              |                              |                                |                    |  |
| No.                                     | Date      | Ref. 1<br>PM2,5<br>[µg/m³] | Ref. 2<br>PM2,5<br>[µg/m³] | Ref. 1<br>PM10<br>[µg/m³] | Ref. 2<br>PM10<br>[µg/m³] | Ratio<br>PM2,5/PM10<br>[%] | SN 17010<br>PM2,5<br>[µg/m³] | SN 17011<br>PM2,5<br>[µg/m³] | Remark                         | Test site          |  |
| 361                                     | 1/23/2010 | 21.0                       | 20.9                       | 25.8                      | 25.1                      | 82.3                       | 19.5                         | 19.8                         |                                | Teddington, Winter |  |
| 362                                     | 1/24/2010 | 16.2                       | 15.9                       | 20.7                      | 20.3                      | 78.4                       | 14.0                         | 16.5                         |                                |                    |  |
| 363                                     | 1/25/2010 | 36.1                       | 35.8                       | 42.0                      | 42.4                      | 85.1                       | 35.6                         | 38.9                         |                                |                    |  |
| 364                                     | 1/26/2010 | 50.7                       | 51.1                       | 60.4                      | 60.4                      | 84.2                       | 47.4                         | 50.8                         |                                |                    |  |
| 365                                     | 1/27/2010 | 27.1                       | 27.3                       | 38.9                      | 39.1                      | 69.7                       | 24.0                         | 26.4                         |                                |                    |  |
| 366                                     | 1/28/2010 | 8.3                        | 8.0                        | 13.9                      | 14.1                      | 58.3                       | 8.2                          | 9.2                          |                                |                    |  |
| 367                                     | 1/29/2010 | 5.7                        | 6.0                        | 9.4                       | 9.6                       | 61.5                       | 6.3                          | 6.8                          |                                |                    |  |
| 368                                     | 1/30/2010 | 12.4                       | 12.5                       | 17.6                      | 17.6                      | 70.7                       | 11.5                         | 13.7                         |                                |                    |  |
| 369                                     | 1/31/2010 | 12.2                       | 13.0                       | 17.3                      | 16.9                      | 73.5                       | 11.7                         | 14.2                         |                                |                    |  |
| 370                                     | 2/1/2010  | 8.4                        | 8.3                        | 14.7                      | 14.4                      | 57.5                       | 8.1                          | 9.6                          |                                |                    |  |
| 371                                     | 2/2/2010  | 8.3                        | 8.3                        | 12.0                      | 11.7                      | 70.0                       | 7.7                          | 10.1                         |                                |                    |  |
| 372                                     | 2/3/2010  | 9.4                        | 9.3                        | 19.2                      | 19.2                      | 48.6                       | 9.0                          | 11.3                         |                                |                    |  |
| 373                                     | 2/4/2010  | 12.0                       | 12.4                       | 19.7                      | 19.8                      | 61.7                       | 11.5                         | 13.4                         |                                |                    |  |

Addendum to the report on performance testing, report no. 936/21209919/A of 26 March 2010 for the BAM-1020 with PM2,5 pre-separator for suspended particulate matter PM2,5 manufactured by Met One Instruments, Inc., Report No.: 936/21243375/A

**Annex 6**

**Ambient conditions at the field test sites**

| No. | Date      | Test site          | Amb. temperature (avg)<br>[°C] | Amb. pressure<br>[hPa] | Rel. humidity<br>[%] | Wind velocity<br>[m/s] | Wind direction<br>[°] | Precipitation<br>[mm] |
|-----|-----------|--------------------|--------------------------------|------------------------|----------------------|------------------------|-----------------------|-----------------------|
| 1   | 7/24/2008 | Teddington, Summer |                                |                        |                      |                        |                       |                       |
| 2   | 7/25/2008 |                    |                                |                        |                      |                        |                       |                       |
| 3   | 7/26/2008 |                    |                                |                        |                      |                        |                       |                       |
| 4   | 7/27/2008 |                    |                                |                        |                      |                        |                       |                       |
| 5   | 7/28/2008 |                    |                                |                        |                      |                        |                       |                       |
| 6   | 7/29/2008 |                    |                                |                        |                      |                        |                       |                       |
| 7   | 7/30/2008 |                    |                                |                        |                      |                        |                       |                       |
| 8   | 7/31/2008 |                    |                                |                        |                      |                        |                       |                       |
| 9   | 8/1/2008  |                    |                                |                        |                      |                        |                       |                       |
| 10  | 8/2/2008  |                    |                                |                        |                      |                        |                       |                       |
| 11  | 8/3/2008  |                    |                                |                        |                      |                        |                       |                       |
| 12  | 8/4/2008  |                    |                                |                        |                      |                        |                       |                       |
| 13  | 8/5/2008  |                    |                                |                        |                      |                        |                       |                       |
| 14  | 8/6/2008  |                    |                                |                        |                      |                        |                       |                       |
| 15  | 8/7/2008  |                    |                                |                        |                      |                        |                       |                       |
| 16  | 8/8/2008  |                    |                                |                        |                      |                        |                       |                       |
| 17  | 8/9/2008  |                    |                                |                        |                      |                        |                       |                       |
| 18  | 8/10/2008 |                    |                                |                        |                      |                        |                       |                       |
| 19  | 8/11/2008 |                    |                                |                        |                      |                        |                       |                       |
| 20  | 8/12/2008 |                    |                                |                        |                      |                        |                       |                       |
| 21  | 8/13/2008 |                    |                                |                        |                      |                        |                       |                       |
| 22  | 8/14/2008 |                    |                                |                        |                      |                        |                       |                       |
| 23  | 8/15/2008 |                    |                                |                        |                      |                        |                       |                       |
| 24  | 8/16/2008 |                    |                                |                        |                      |                        |                       |                       |
| 25  | 8/17/2008 |                    |                                |                        |                      |                        |                       |                       |
| 26  | 8/18/2008 |                    |                                |                        |                      |                        |                       |                       |
| 27  | 8/19/2008 |                    |                                |                        |                      |                        |                       |                       |
| 28  | 8/20/2008 |                    |                                |                        |                      |                        |                       |                       |
| 29  | 8/21/2008 |                    |                                |                        |                      |                        |                       |                       |
| 30  | 8/22/2008 |                    |                                |                        |                      |                        |                       |                       |

No weather data available

**Annex 6**

**Ambient conditions at the field test sites**

| No. | Date      | Test site          | Amb. temperature (avg)<br>[°C] | Amb. pressure<br>[hPa] | Rel. humidity<br>[%] | Wind velocity<br>[m/s] | Wind direction<br>[°] | Precipitation<br>[mm] |  |
|-----|-----------|--------------------|--------------------------------|------------------------|----------------------|------------------------|-----------------------|-----------------------|--|
| 31  | 8/23/2008 | Teddington, Summer |                                |                        |                      |                        |                       |                       |  |
| 32  | 8/24/2008 |                    |                                |                        |                      |                        |                       |                       |  |
| 34  | 8/25/2008 |                    |                                |                        |                      |                        |                       |                       |  |
| 34  | 8/26/2008 |                    |                                |                        |                      |                        |                       |                       |  |
| 35  | 8/27/2008 |                    |                                |                        |                      |                        |                       |                       |  |
| 36  | 8/28/2008 |                    |                                |                        |                      |                        |                       |                       |  |
| 37  | 8/29/2008 |                    |                                |                        |                      |                        |                       |                       |  |
| 38  | 8/30/2008 |                    |                                |                        |                      |                        |                       |                       |  |
| 39  | 8/31/2008 |                    |                                |                        |                      |                        |                       |                       |  |
| 40  | 9/1/2008  |                    |                                |                        |                      |                        |                       |                       |  |
| 41  | 9/2/2008  |                    |                                |                        |                      |                        |                       |                       |  |
| 42  | 9/3/2008  |                    |                                |                        |                      |                        |                       |                       |  |
| 43  | 9/4/2008  |                    |                                |                        |                      |                        |                       |                       |  |
| 44  | 9/5/2008  |                    |                                |                        |                      |                        |                       |                       |  |
| 45  | 9/6/2008  |                    |                                |                        |                      |                        |                       |                       |  |
| 46  | 9/7/2008  |                    |                                |                        |                      |                        |                       |                       |  |
| 47  | 9/8/2008  |                    |                                |                        |                      |                        |                       |                       |  |
| 48  | 9/9/2008  |                    |                                |                        |                      |                        |                       |                       |  |
| 49  | 9/10/2008 |                    |                                |                        |                      |                        |                       |                       |  |
| 50  | 9/11/2008 |                    |                                |                        |                      |                        |                       |                       |  |
| 51  | 9/12/2008 |                    |                                |                        |                      |                        |                       |                       |  |
| 52  | 9/13/2008 |                    |                                |                        |                      |                        |                       |                       |  |
| 53  | 9/14/2008 |                    |                                |                        |                      |                        |                       |                       |  |
| 54  | 9/15/2008 |                    |                                |                        |                      |                        |                       |                       |  |
| 55  | 9/16/2008 |                    |                                |                        |                      |                        |                       |                       |  |
| 56  | 9/17/2008 |                    |                                | 14.5                   | 1004.7               | 68.1                   | 0.6                   | 152.9                 |  |
| 57  | 9/18/2008 |                    |                                | 11.6                   | 1007.1               | 72.0                   | 0.5                   | 195.4                 |  |
| 58  | 9/19/2008 |                    |                                | 12.8                   | 1012.3               | 70.1                   | 0.3                   | 169.8                 |  |
| 59  | 9/20/2008 |                    |                                | 13.1                   | 1011.1               | 70.5                   | 0.5                   | 116.4                 |  |
| 60  | 9/21/2008 |                    |                                | 13.2                   | 1007.7               | 70.0                   | 0.6                   | 168.0                 |  |

No weather data available

**Annex 6**

**Ambient conditions at the field test sites**

**Page 3 of 13**

| No. | Date       | Test site          | Amb. temperature (avg)<br>[°C] | Amb. pressure<br>[hPa] | Rel. humidity<br>[%] | Wind velocity<br>[m/s] | Wind direction<br>[°] | Precipitation<br>[mm] |
|-----|------------|--------------------|--------------------------------|------------------------|----------------------|------------------------|-----------------------|-----------------------|
| 61  | 9/22/2008  | Teddington, Summer | 14.8                           | 1006.2                 | 76.5                 | 1.1                    | 211.1                 |                       |
| 62  | 9/23/2008  |                    | 14.4                           | 1005.5                 | 76.0                 | 1.8                    | 228.3                 |                       |
| 63  | 9/24/2008  |                    | 14.8                           | 1009.9                 | 81.9                 | 0.8                    | 168.0                 |                       |
| 64  | 9/25/2008  |                    | 13.3                           | 1016.0                 | 74.7                 | 0.7                    | 88.8                  |                       |
| 65  | 9/26/2008  |                    | 13.4                           | 1015.9                 | 75.6                 | 0.7                    | 146.4                 |                       |
| 66  | 9/27/2008  |                    | 12.0                           | 1011.2                 | 80.6                 | 0.1                    | 206.1                 |                       |
| 67  | 9/28/2008  |                    | 13.9                           | 1005.1                 | 70.7                 | 0.2                    | 299.8                 |                       |
| 68  | 9/29/2008  |                    | 14.0                           | 996.5                  | 71.7                 | 0.3                    | 234.6                 |                       |
| 69  | 9/30/2008  |                    | 13.7                           | 983.7                  | 83.8                 | 0.4                    | 209.8                 |                       |
| 70  | 10/1/2008  |                    | 10.4                           | 985.3                  | 71.9                 | 0.4                    | 232.2                 |                       |
| 71  | 10/2/2008  |                    | 9.5                            | 988.5                  | 69.7                 | 0.7                    | 271.6                 |                       |
| 72  | 10/3/2008  |                    | 9.3                            | 998.5                  | 64.0                 | 0.6                    | 278.5                 |                       |
| 73  | 10/4/2008  |                    | 14.1                           | 984.7                  | 87.0                 | 1.1                    | 179.0                 |                       |
| 74  | 10/5/2008  |                    | 10.1                           | 986.7                  | 88.7                 | 0.6                    | 259.1                 |                       |
| 75  | 10/6/2008  |                    | 14.8                           | 991.4                  | 87.0                 | 0.9                    | 161.0                 |                       |
| 76  | 10/7/2008  |                    | 12.7                           | 991.2                  | 89.6                 | 0.6                    | 219.1                 |                       |
| 77  | 10/8/2008  |                    | 9.6                            | 1007.9                 | 80.6                 | 0.2                    | 276.5                 |                       |
| 78  | 10/9/2008  |                    | 13.3                           | 1012.5                 | 80.2                 | 0.3                    | 183.9                 |                       |
| 79  | 10/10/2008 |                    | 12.0                           | 1009.0                 | 84.4                 | 0.4                    | 210.4                 |                       |
| 80  | 10/11/2008 |                    | 12.8                           | 1006.9                 | 85.9                 | 0.2                    | 197.8                 |                       |
| 81  | 10/12/2008 |                    | 15.4                           | 1000.7                 | 86.5                 | 0.3                    | 206.3                 |                       |
| 82  | 10/13/2008 |                    | 12.5                           | 1001.0                 | 90.9                 | 0.1                    | 209.4                 |                       |
| 83  | 10/14/2008 |                    | 14.4                           | 997.5                  | 90.5                 | 0.3                    | 191.7                 |                       |
| 84  | 10/15/2008 |                    | 12.1                           | 994.4                  | 86.8                 | 0.3                    | 255.0                 |                       |
| 85  | 10/16/2008 |                    | 8.2                            | 1001.0                 | 78.7                 | 0.4                    | 240.5                 |                       |
| 86  | 10/17/2008 |                    | 9.0                            | 1002.0                 | 83.8                 | 0.0                    | 228.9                 |                       |
| 87  | 10/18/2008 |                    | 10.6                           | 1001.3                 | 83.3                 | 0.1                    | 212.7                 |                       |
| 88  | 10/19/2008 |                    | 14.0                           | 994.8                  | 76.3                 | 0.8                    | 192.2                 |                       |
| 89  | 10/20/2008 |                    | 11.2                           | 988.7                  | 90.2                 | 0.4                    | 203.4                 |                       |
| 90  | 10/21/2008 |                    | 6.7                            | 999.4                  | 80.5                 | 0.2                    | 214.1                 |                       |



**Annex 6**
**Ambient conditions at the field test sites**
**Page 4 of 13**

| No. | Date       | Test site          | Amb. temperature (avg)<br>[°C] | Amb. pressure<br>[hPa] | Rel. humidity<br>[%] | Wind velocity<br>[m/s] | Wind direction<br>[°] | Precipitation<br>[mm] |  |
|-----|------------|--------------------|--------------------------------|------------------------|----------------------|------------------------|-----------------------|-----------------------|--|
| 91  | 10/22/2008 | Teddington, Summer | 9.4                            | 1006.1                 | 80.9                 | 0.2                    | 226.1                 |                       |  |
| 92  | 10/23/2008 |                    | 13.6                           | 999.6                  | 79.8                 | 1.0                    | 195.0                 |                       |  |
| 93  | 10/24/2008 |                    | 6.5                            | 1010.6                 | 85.1                 | 0.2                    | 250.0                 |                       |  |
| 94  | 10/25/2008 |                    | 14.1                           | 1002.3                 | 81.8                 | 0.9                    | 193.8                 |                       |  |
| 95  | 10/26/2008 |                    | 9.2                            | 995.1                  | 95.0                 | 0.0                    | 226.6                 |                       |  |
| 96  | 10/27/2008 |                    | 4.2                            | 994.2                  | 85.6                 | 0.1                    | 285.3                 |                       |  |
| 97  | 10/28/2008 |                    | 4.3                            | 994.2                  | 81.7                 | 0.5                    | 252.7                 |                       |  |
| 98  | 10/29/2008 |                    | 4.3                            | 984.0                  | 77.8                 | 0.4                    | 152.8                 |                       |  |
| 99  | 10/30/2008 |                    | 5.3                            | 985.1                  | 79.6                 | 1.1                    | 161.5                 |                       |  |
| 100 | 10/31/2008 |                    | 5.7                            | 991.6                  | 80.1                 | 0.9                    | 244.7                 |                       |  |
| 101 | 11/1/2008  |                    | 8.8                            | 988.8                  | 91.5                 | 1.2                    | 233.2                 |                       |  |
| 102 | 11/2/2008  |                    | 10.1                           | 997.2                  | 88.9                 | 0.8                    | 223.8                 |                       |  |
| 103 | 11/3/2008  |                    | 10.6                           | 998.1                  | 93.6                 | 0.9                    | 150.9                 |                       |  |
| 104 | 11/4/2008  |                    | 11.4                           | 1001.0                 | 86.2                 | 0.8                    | 179.1                 |                       |  |
| 105 | 11/5/2008  |                    | 10.5                           | 998.4                  | 92.6                 | 0.5                    | 284.0                 |                       |  |
| 106 | 11/6/2008  |                    | 10.5                           | 991.8                  | 90.7                 | 0.4                    | 161.0                 |                       |  |
| 107 | 11/7/2008  |                    |                                |                        |                      |                        |                       |                       |  |
| 108 | 11/8/2008  |                    |                                |                        |                      |                        |                       |                       |  |
| 109 | 11/9/2008  |                    |                                |                        |                      |                        |                       |                       |  |
|     |            |                    | No weather data available      |                        |                      |                        |                       |                       |  |
| 110 | 12/4/2008  | Cologne, Winter    | 4.4                            | 980.2                  | 77.0                 | 3.7                    | 61.4                  | 4.5                   |  |
| 111 | 12/5/2008  |                    | 5.6                            | 987.6                  | 76.4                 | 1.7                    | 109.2                 | 12.1                  |  |
| 112 | 12/6/2008  |                    | 5.1                            | 1007.5                 | 81.1                 | 1.7                    | 150.2                 | 3.6                   |  |
| 113 | 12/7/2008  |                    | 2.0                            | 1020.6                 | 82.1                 | 0.1                    | 150.4                 | 0.3                   |  |
| 114 | 12/8/2008  |                    | 0.3                            | 1013.0                 | 80.5                 | 1.1                    | 186.1                 | 0.3                   |  |
| 115 | 12/9/2008  |                    | 1.3                            | 1006.3                 | 82.4                 | 0.3                    | 124.2                 | 6.5                   |  |
| 116 | 12/10/2008 |                    | 1.3                            | 1004.8                 | 81.3                 | 0.2                    | 180.1                 | 2.1                   |  |
| 117 | 12/11/2008 |                    | 0.0                            | 1006.9                 | 81.6                 | 0.5                    | 244.0                 | 0.0                   |  |
| 118 | 12/12/2008 |                    | -0.5                           | 1009.1                 | 74.3                 | 4.4                    | 108.3                 | 0.0                   |  |
| 119 | 12/13/2008 |                    | 0.7                            | 994.1                  | 69.9                 | 5.3                    | 193.9                 | 0.0                   |  |
| 120 | 12/14/2008 |                    | -0.4                           | 998.5                  | 78.2                 | 0.4                    | 172.9                 | 0.0                   |  |

**Annex 6**

**Ambient conditions at the field test sites**

| No. | Date       | Test site       | Amb. temperature (avg)<br>[°C] | Amb. pressure<br>[hPa] | Rel. humidity<br>[%] | Wind velocity<br>[m/s] | Wind direction<br>[°] | Precipitation<br>[mm] |
|-----|------------|-----------------|--------------------------------|------------------------|----------------------|------------------------|-----------------------|-----------------------|
| 121 | 12/15/2008 | Cologne, Winter | 1.6                            | 1009.1                 | 80.1                 | 0.1                    | 163.9                 | 0.0                   |
| 122 | 12/16/2008 |                 | -0.8                           | 1006.2                 | 81.8                 | 0.3                    | 93.4                  | 0.0                   |
| 123 | 12/17/2008 |                 | 0.9                            | 1009.0                 | 84.6                 | 0.4                    | 117.2                 | 4.2                   |
| 124 | 12/18/2008 |                 | 4.5                            | 1011.9                 | 81.3                 | 2.1                    | 107.8                 | 3.9                   |
| 125 | 12/19/2008 |                 | 5.8                            | 1015.8                 | 74.9                 | 3.1                    | 105.9                 | 8.3                   |
| 126 | 12/20/2008 |                 | 7.8                            | 1018.4                 | 81.5                 | 2.2                    | 139.3                 | 17.1                  |
| 127 | 12/21/2008 |                 | 9.1                            | 1023.3                 | 77.9                 | 4.2                    | 136.1                 | 1.5                   |
| 128 | 12/22/2008 |                 | 7.1                            | 1026.1                 | 80.4                 | 1.6                    | 143.9                 | 0.3                   |
| 129 | 12/23/2008 |                 | 4.9                            | 1028.0                 | 82.8                 | 0.1                    | 163.2                 | 0.0                   |
| 130 | 12/24/2008 |                 | 5.4                            | 1023.3                 | 79.4                 | 1.2                    | 175.9                 | 0.0                   |
| 131 | 12/25/2008 |                 | 1.6                            | 1028.1                 | 68.0                 | 0.6                    | 270.6                 | 0.0                   |
| 132 | 12/26/2008 |                 | -1.3                           | 1029.8                 | 62.5                 | 0.7                    | 265.8                 | 0.0                   |
| 134 | 12/27/2008 |                 | -3.4                           | 1026.8                 | 69.9                 | 0.7                    | 268.2                 | 0.0                   |
| 134 | 12/28/2008 |                 | -4.7                           | 1022.7                 | 71.8                 | 0.6                    | 253.1                 | 0.0                   |
| 135 | 12/29/2008 |                 | -2.7                           | 1024.1                 | 67.3                 | 0.4                    | 257.9                 | 0.0                   |
| 136 | 12/30/2008 |                 | -3.3                           | 1021.6                 | 68.6                 | 0.6                    | 301.2                 | 0.0                   |
| 137 | 12/31/2008 |                 | -3.1                           | 1019.5                 | 75.1                 | 0.8                    | 125.8                 | 0.0                   |
| 138 | 1/1/2009   |                 | -2.9                           | 1021.1                 | 77.5                 | 0.1                    | 159.3                 | 0.0                   |
| 139 | 1/2/2009   |                 | Down time                      | 1021.5                 | Down time            | Down time              | Down time             | 0.0                   |
| 140 | 1/3/2009   |                 | -0.4                           | 1017.5                 | 68.8                 | 1.5                    | 187.7                 | 0.0                   |
| 141 | 1/4/2009   |                 | -0.6                           | 1010.0                 | 75.6                 | 2.4                    | 161.5                 | 0.0                   |
| 142 | 1/5/2009   |                 | -4.0                           | 1015.4                 | 70.6                 | 0.0                    | 253.5                 | 1.2                   |
| 143 | 1/6/2009   |                 | -14.0                          | 1016.0                 | 76.0                 | 0.4                    | 187.3                 | 0.0                   |
| 144 | 1/7/2009   |                 | -6.8                           | 1019.0                 | 76.6                 | 0.3                    | 161.0                 | 0.0                   |
| 145 | 1/8/2009   |                 | -8.5                           | 1023.0                 | 78.6                 | 0.1                    | 249.4                 | 0.0                   |
| 146 | 1/9/2009   |                 | -7.7                           | 1021.9                 | 71.6                 | 0.3                    | 209.0                 | 0.3                   |
| 147 | 1/10/2009  |                 | -5.1                           | 1022.4                 | 65.5                 | 1.0                    | 198.3                 | 0.0                   |
| 148 | 1/11/2009  |                 | -2.4                           | 1021.0                 | 61.9                 | 2.1                    | 234.1                 | 0.0                   |
| 149 | 1/12/2009  |                 | 2.3                            | 1010.9                 | 58.8                 | 4.7                    | 181.9                 | 0.3                   |
| 150 | 1/13/2009  |                 | 2.4                            | 1006.4                 | 67.3                 | 2.4                    | 73.5                  | 3.0                   |

**Annex 6**
**Ambient conditions at the field test sites**
**Page 6 of 13**

| No. | Date      | Test site       | Amb. temperature (avg)<br>[°C] | Amb. pressure<br>[hPa] | Rel. humidity<br>[%] | Wind velocity<br>[m/s] | Wind direction<br>[°] | Precipitation<br>[mm] |
|-----|-----------|-----------------|--------------------------------|------------------------|----------------------|------------------------|-----------------------|-----------------------|
| 151 | 1/14/2009 | Cologne, Winter | 2.1                            | 1010.8                 | 81.4                 | 0.0                    | 147.0                 | 0.3                   |
| 152 | 1/15/2009 |                 | 1.4                            | 1013.9                 | 69.4                 | 3.0                    | 209.4                 | 0.0                   |
| 153 | 1/16/2009 |                 | 2.1                            | 1012.5                 | 73.2                 | 4.0                    | 170.6                 | 0.0                   |
| 154 | 1/17/2009 |                 | 5.4                            | 1004.0                 | 72.4                 | 4.2                    | 117.3                 | 0.9                   |
| 155 | 1/18/2009 |                 | 3.8                            | 993.4                  | 73.5                 | 3.7                    | 106.3                 | 3.5                   |
| 156 | 1/19/2009 |                 | 5.7                            | 982.8                  | 72.2                 | 5.1                    | 75.6                  | 5.6                   |
| 157 | 1/20/2009 |                 | 0.3                            | 994.1                  | 76.8                 | 0.6                    | 159.6                 | 0.3                   |
| 158 | 1/21/2009 |                 | 2.0                            | 999.7                  | 72.8                 | 2.3                    | 127.5                 | 0.0                   |
| 159 | 1/22/2009 |                 | 4.1                            | 982.6                  | 72.4                 | 6.9                    | 122.9                 | 14.5                  |
| 160 | 1/23/2009 |                 | 3.8                            | 970.9                  | 76.1                 | 4.9                    | 114.9                 | 12.1                  |
| 161 | 1/24/2009 |                 | 1.9                            | 988.2                  | 77.2                 | 0.8                    | 158.4                 | 0.0                   |
| 162 | 1/25/2009 |                 | 1.4                            | 991.3                  | 72.3                 | 2.4                    | 266.9                 | 0.0                   |
| 163 | 1/26/2009 |                 | 0.3                            | 999.1                  | 71.8                 | 0.9                    | 191.8                 | 0.0                   |
| 164 | 1/27/2009 |                 | 1.3                            | 1009.4                 | 65.9                 | 0.4                    | 224.6                 | 0.0                   |
| 165 | 1/28/2009 |                 | 0.1                            | 1012.6                 | 69.6                 | 0.6                    | 226.4                 | 0.0                   |
| 166 | 1/29/2009 |                 | -0.2                           | 1015.3                 | 67.0                 | 1.8                    | 254.8                 | 0.0                   |
| 167 | 1/30/2009 |                 | -0.6                           | 1014.4                 | 67.2                 | 2.8                    | 237.0                 | 0.0                   |
| 168 | 1/31/2009 |                 | 0.7                            | 1008.8                 | 56.2                 | 3.3                    | 284.1                 | 0.0                   |
| 169 | 2/1/2009  |                 | -0.3                           | 998.8                  | 59.4                 | 3.6                    | 289.1                 | 0.0                   |
| 170 | 2/2/2009  |                 | 3.0                            | 991.8                  | 62.3                 | 2.2                    | 269.9                 | 0.0                   |
| 171 | 2/3/2009  | 0.9             | 992.3                          | 78.8                   | 0.0                  | 73.6                   | 0.6                   |                       |
| 172 | 2/4/2009  | 3.1             | 988.9                          | 76.5                   | 0.8                  | 137.7                  | 0.0                   |                       |
| 173 | 2/5/2009  | Down time       | 986.9                          | Down time              | Down time            | Down time              | 0.0                   |                       |
| 174 | 2/6/2009  | 2.0             | 983.0                          | 83.1                   | 0.0                  | 250.0                  | 0.3                   |                       |
| 175 | 2/7/2009  | 2.1             | 988.1                          | 78.4                   | 2.4                  | 156.5                  | 0.6                   |                       |
| 176 | 2/8/2009  | 1.8             | 998.3                          | 72.0                   | 2.0                  | 130.6                  | 0.0                   |                       |
| 177 | 2/9/2009  | 4.2             | 987.0                          | 74.6                   | 5.4                  | 130.8                  | 15.3                  |                       |
| 178 | 2/10/2009 | 2.7             | 993.9                          | 76.1                   | 6.5                  | 138.0                  | 16.8                  |                       |
| 179 | 2/11/2009 | 0.9             | 1007.2                         | 75.1                   | 1.4                  | 138.8                  | 2.7                   |                       |
| 180 | 2/12/2009 | 0.8             | 1012.5                         | 77.0                   | 0.4                  | 175.0                  | 0.0                   |                       |

**Annex 6**

**Ambient conditions at the field test sites**

| No. | Date      | Test site       | Amb. temperature (avg)<br>[°C] | Amb. pressure<br>[hPa] | Rel. humidity<br>[%] | Wind velocity<br>[m/s] | Wind direction<br>[°] | Precipitation<br>[mm] |
|-----|-----------|-----------------|--------------------------------|------------------------|----------------------|------------------------|-----------------------|-----------------------|
| 181 | 2/13/2009 | Cologne, Winter | 0.2                            | 1013.0                 | 75.7                 | 0.6                    | 208.2                 | 4.1                   |
| 182 | 2/14/2009 |                 | -1.6                           | 1021.2                 | 71.9                 | 0.8                    | 205.8                 | 0.0                   |
| 183 | 2/15/2009 |                 | 0.6                            | 1016.8                 | 78.2                 | 0.9                    | 136.5                 | 10.6                  |
| 184 | 2/16/2009 |                 | 5.7                            | 1011.2                 | 83.4                 | 3.8                    | 149.9                 | 21.5                  |
| 185 | 2/17/2009 |                 | 0.5                            | 1017.1                 | 71.6                 | 1.8                    | 269.0                 | 0.6                   |
| 186 | 2/18/2009 |                 | -0.7                           | 1019.4                 | 62.6                 | 0.8                    | 233.1                 | 0.0                   |
| 187 | 2/19/2009 |                 | 3.1                            | 1019.3                 | 68.8                 | 1.2                    | 180.2                 | 3.9                   |
| 188 | 2/20/2009 |                 | 4.5                            | 1021.6                 | 80.9                 | 2.2                    | 156.9                 | 2.4                   |
| 189 | 2/21/2009 |                 | 5.3                            | 1020.0                 | 74.2                 | 1.2                    | 123.9                 | 4.4                   |
| 190 | 2/22/2009 |                 | 5.8                            | 1012.6                 | 78.3                 | 4.5                    | 153.0                 | 3.9                   |
| 191 | 2/23/2009 |                 | 5.1                            | 1013.1                 | 71.9                 | 3.1                    | 173.8                 | 0.6                   |
| 192 | 2/24/2009 |                 | 2.2                            | 1021.0                 | 75.5                 | 0.9                    | 167.8                 | 0.0                   |
| 193 | 2/25/2009 |                 | 6.3                            | 1017.7                 | 71.2                 | 2.9                    | 125.0                 | 0.6                   |
| 194 | 2/26/2009 |                 | 7.1                            | 1011.5                 | 69.8                 | 5.0                    | 141.8                 | 0.6                   |
| 195 | 2/27/2009 |                 | 7.8                            | 1010.7                 | 79.3                 | 2.2                    | 121.5                 | 0.9                   |
| 196 | 2/28/2009 |                 | 7.6                            | 1005.0                 | 76.6                 | 0.7                    | 203.5                 | 0.0                   |
| 197 | 3/1/2009  |                 | 9.5                            | 1002.2                 | 74.3                 | 2.1                    | 119.4                 | 3.0                   |
| 198 | 3/2/2009  |                 | 5.1                            | 1008.9                 | 70.6                 | 1.4                    | 135.2                 | 0.0                   |
| 199 | 3/3/2009  |                 | 6.8                            | 996.3                  | 58.0                 | 5.0                    | 126.5                 | 0.0                   |
| 200 | 3/4/2009  |                 | 6.9                            | 980.1                  | 67.7                 | 3.0                    | 95.7                  | 6.2                   |
| 201 | 3/5/2009  |                 | 4.2                            | 984.5                  | 81.2                 | 4.0                    | 176.4                 | 26.9                  |
| 202 | 3/6/2009  |                 | 3.7                            | 998.0                  | 77.6                 | 4.6                    | 153.8                 | 6.5                   |
| 203 | 3/7/2009  |                 | 8.0                            | 1003.0                 | 69.7                 | 1.3                    | 89.3                  | 0.6                   |
| 204 | 3/8/2009  |                 | 6.2                            | 997.6                  | 68.3                 | 3.7                    | 120.8                 | 5.0                   |
| 205 | 3/9/2009  |                 | 5.9                            | 1004.3                 | 67.8                 | 4.3                    | 118.5                 | 3.3                   |
| 206 | 3/10/2009 |                 | 5.4                            | 1004.3                 | 75.7                 | 4.5                    | 123.9                 | 7.7                   |
| 207 | 3/11/2009 |                 | 5.4                            | 1016.0                 | 69.7                 | 1.7                    | 96.3                  | 2.4                   |
| 208 | 3/12/2009 |                 | 7.7                            | 1012.1                 | 81.9                 | 2.1                    | 157.6                 | 11.0                  |
| 209 | 3/13/2009 |                 | 8.1                            | 1012.2                 | 67.9                 | 1.1                    | 155.3                 | 0.0                   |
| 210 | 3/14/2009 |                 | 9.9                            | 1012.2                 | 70.3                 | 3.9                    | 176.7                 | 1.5                   |

**Annex 6**

**Ambient conditions at the field test sites**

| No. | Date      | Test site       | Amb. temperature (avg)<br>[°C] | Amb. pressure<br>[hPa] | Rel. humidity<br>[%] | Wind velocity<br>[m/s] | Wind direction<br>[°] | Precipitation<br>[mm] |
|-----|-----------|-----------------|--------------------------------|------------------------|----------------------|------------------------|-----------------------|-----------------------|
| 211 | 3/15/2009 | Cologne, Winter | 8.0                            | 1022.9                 | 72.8                 | 2.8                    | 153.4                 | 0.0                   |
| 212 | 3/16/2009 |                 | 7.0                            | 1025.4                 | 72.6                 | 0.1                    | 147.8                 | 0.0                   |
| 213 | 3/17/2009 |                 | 6.1                            | 1027.5                 | 66.7                 | 0.4                    | 204.0                 | 0.0                   |
| 214 | 3/18/2009 |                 | 4.6                            | 1021.1                 | 59.6                 | 0.1                    | 218.6                 | 0.0                   |
| 215 | 3/19/2009 |                 | 5.4                            | 1022.0                 | 57.3                 | 0.6                    | 199.4                 | 0.0                   |
| 216 | 3/20/2009 |                 | 4.6                            | 1023.1                 | 50.9                 | 0.8                    | 234.3                 | 0.0                   |
| 217 | 3/21/2009 |                 | 5.6                            | 1019.3                 | 58.1                 | 1.2                    | 139.8                 | 0.0                   |
| 218 | 3/22/2009 |                 | 8.5                            | 1015.0                 | 63.4                 | 5.3                    | 164.1                 | 0.0                   |
| 219 | 4/2/2009  |                 | 5.3                            | 998.8                  | 71.5                 | 6.5                    | 144.3                 | 9.2                   |
| 220 | 4/3/2009  |                 | 3.5                            | 1001.0                 | 67.4                 | 3.2                    | 114.1                 | 9.2                   |
| 221 | 4/4/2009  |                 | 5.4                            | 994.9                  | 75.6                 | 3.8                    | 131.6                 | 8.6                   |
| 222 | 4/5/2009  |                 | 7.3                            | 993.8                  | 74.3                 | 3.6                    | 95.2                  | 14.5                  |
| 223 | 4/6/2009  |                 | 6.9                            | 990.3                  | 66.5                 | 3.9                    | 91.8                  | 1.8                   |
| 224 | 4/7/2009  |                 | 6.5                            | 994.7                  | 70.8                 | 3.3                    | 122.3                 | 3.9                   |
| 225 | 4/8/2009  |                 | 4.8                            | 1007.7                 | 70.0                 | 0.9                    | 185.6                 | 0.3                   |
| 226 | 4/9/2009  |                 | 5.2                            | 1015.9                 | 65.9                 | 0.7                    | 161.6                 | 0.0                   |
| 227 | 4/10/2009 |                 | 10.3                           | 1013.7                 | 50.7                 | 0.9                    | 210.0                 | 0.0                   |
| 228 | 4/11/2009 |                 | 12.9                           | 1011.2                 | 48.2                 | 1.5                    | 247.4                 | 0.0                   |
| 229 | 4/2/2009  |                 | 14.9                           | 1008.3                 | 55.0                 | 1.2                    | 203.4                 | 0.0                   |
| 230 | 4/3/2009  |                 | 17.0                           | 1008.8                 | 58.6                 | 1.5                    | 116.0                 | 0.0                   |
| 231 | 4/4/2009  |                 | 13.6                           | 1014.1                 | 64.4                 | 0.9                    | 170.3                 | 0.0                   |
| 232 | 4/5/2009  |                 | 11.6                           | 1012.5                 | 68.2                 | 0.6                    | 207.5                 | 0.0                   |
| 234 | 4/6/2009  |                 | 16.0                           | 1002.3                 | 54.5                 | 1.5                    | 226.7                 | 0.0                   |
| 234 | 4/7/2009  |                 | 12.7                           | 1004.8                 | 70.5                 | 1.9                    | 94.5                  | 6.5                   |
| 235 | 4/8/2009  |                 | 13.0                           | 1007.1                 | 66.5                 | 2.5                    | 136.7                 | 0.9                   |
| 236 | 4/9/2009  |                 | 15.5                           | 1005.1                 | 62.0                 | 1.5                    | 189.4                 | 0.0                   |
| 237 | 4/10/2009 |                 | 17.7                           | 999.7                  | 53.3                 | 1.4                    | 203.8                 | 0.0                   |
| 238 | 4/11/2009 |                 | 17.8                           | 1001.1                 | 56.5                 | 0.5                    | 148.4                 | 0.0                   |
| 239 | 4/12/2009 |                 | 15.1                           | 1002.6                 | 73.3                 | 0.9                    | 166.7                 | 0.0                   |
| 240 | 4/13/2009 |                 | 12.4                           | 1002.0                 | 76.5                 | 0.1                    | 184.0                 | 0.0                   |

Addendum to the report on performance testing, report no. 936/21209919/A of  
26 March 2010 for the BAM-1020 with PM2,5 pre-separator for suspended  
particulate matter PM2,5 manufactured by Met One Instruments, Inc., Report  
No.: 936/21243375/A

Page 145 of 160

**Annex 6**

**Ambient conditions at the field test sites**

**Page 9 of 13**

| No. | Date      | Test site        | Amb. temperature (avg)<br>[°C] | Amb. pressure<br>[hPa] | Rel. humidity<br>[%] | Wind velocity<br>[m/s] | Wind direction<br>[°] | Precipitation<br>[mm] |
|-----|-----------|------------------|--------------------------------|------------------------|----------------------|------------------------|-----------------------|-----------------------|
| 241 | 8/9/2009  | Bornheim, Summer | 20.0                           | 1008.6                 | 72.3                 | 0.0                    | defective             | 0.0                   |
| 242 | 8/10/2009 |                  | 19.8                           | 1007.4                 | 66.0                 | 0.2                    | defective             | 0.3                   |
| 243 | 8/11/2009 |                  | 19.0                           | 1010.6                 | 70.5                 | 0.5                    | defective             | 0.6                   |
| 244 | 8/12/2009 |                  | 18.7                           | 1009.0                 | 73.5                 | 0.0                    | defective             | 20.0                  |
| 245 | 8/13/2009 |                  | 17.1                           | 1008.7                 | 77.3                 | 0.1                    | defective             | 1.8                   |
| 246 | 8/14/2009 |                  | 17.3                           | 1010.0                 | 70.2                 | 0.0                    | defective             | 0.0                   |
| 247 | 8/15/2009 |                  | 22.3                           | 1007.1                 | 56.2                 | 0.0                    | defective             | 0.0                   |
| 248 | 8/16/2009 |                  | 22.1                           | 1006.5                 | 64.5                 | 0.0                    | defective             | 0.0                   |
| 249 | 8/17/2009 |                  | 20.1                           | 1007.5                 | 64.9                 | 0.4                    | defective             | 0.0                   |
| 250 | 8/18/2009 |                  | 20.4                           | 1012.2                 | 57.7                 | 0.0                    | defective             | 0.0                   |
| 251 | 8/19/2009 |                  | 24.5                           | 1010.2                 | 53.9                 | 0.2                    | defective             | 0.0                   |
| 252 | 8/20/2009 |                  | 25.3                           | 1008.2                 | 61.5                 | 0.5                    | defective             | 17.1                  |
| 253 | 8/21/2009 |                  | 17.2                           | 1013.3                 | 65.4                 | 0.0                    | defective             | 0.3                   |
| 254 | 8/22/2009 |                  | 17.4                           | 1015.6                 | 60.6                 | 0.0                    | defective             | 0.0                   |
| 255 | 8/23/2009 |                  | 19.3                           | 1009.3                 | 55.6                 | 0.4                    | defective             | 0.0                   |
| 256 | 8/24/2009 |                  | 23.0                           | 1000.2                 | 55.5                 | 0.8                    | defective             | 1.5                   |
| 257 | 8/25/2009 |                  | 19.4                           | 1004.1                 | 74.1                 | 0.1                    | defective             | 5.0                   |
| 258 | 8/26/2009 |                  | 16.1                           | 1006.9                 | 74.6                 | 0.0                    | defective             | 0.0                   |
| 259 | 8/27/2009 |                  | 23.4                           | 1005.8                 | 56.4                 | 0.0                    | defective             | 0.0                   |
| 260 | 8/28/2009 |                  | 17.7                           | 1006.0                 | 57.9                 | 0.6                    | defective             | 0.0                   |
| 261 | 8/29/2009 |                  | 14.9                           | 1012.1                 | 57.6                 | 1.1                    | defective             | 0.0                   |
| 262 | 8/30/2009 |                  | 15.7                           | 1012.1                 | 59.6                 | 0.3                    | defective             | 0.0                   |
| 263 | 8/31/2009 |                  | 23.5                           | 1005.5                 | 44.4                 | 0.8                    | defective             | 0.0                   |
| 264 | 9/1/2009  |                  | 14.0                           | 1004.3                 | 80.3                 | 0.0                    | defective             | 12.4                  |
| 265 | 9/2/2009  |                  | 17.5                           | 1001.8                 | 65.9                 | 0.0                    | defective             | 2.4                   |
| 266 | 9/3/2009  |                  | 15.8                           | 995.9                  | 63.8                 | 1.3                    | defective             | 2.4                   |
| 267 | 9/4/2009  |                  | 14.1                           | 1001.3                 | 67.6                 | 1.0                    | defective             | 3.9                   |
| 268 | 9/5/2009  |                  | 13.1                           | 1013.4                 | 70.0                 | 0.6                    | defective             | 4.4                   |
| 269 | 9/6/2009  |                  | 14.7                           | 1015.2                 | 68.4                 | 0.0                    | defective             | 0.0                   |
| 270 | 9/7/2009  |                  | 18.1                           | 1013.4                 | 64.0                 | 0.0                    | defective             | 0.0                   |

**Annex 6**

**Ambient conditions at the field test sites**

| No. | Date      | Test site        | Amb. temperature (avg)<br>[°C] | Amb. pressure<br>[hPa] | Rel. humidity<br>[%] | Wind velocity<br>[m/s] | Wind direction<br>[°] | Precipitation<br>[mm] |
|-----|-----------|------------------|--------------------------------|------------------------|----------------------|------------------------|-----------------------|-----------------------|
| 271 | 9/8/2009  | Bornheim, Summer | 20.6                           | 1013.2                 | 57.8                 | 0.0                    | defective             | 0.0                   |
| 272 | 9/9/2009  |                  | 20.6                           | 1016.5                 | 63.6                 | 0.5                    | defective             | 0.0                   |
| 273 | 9/10/2009 |                  | 15.7                           | 1022.1                 | 68.9                 | 0.3                    | defective             | 0.0                   |
| 274 | 9/11/2009 |                  | 15.7                           | 1021.5                 | 63.1                 | 0.2                    | defective             | 0.0                   |
| 275 | 9/12/2009 |                  | 15.9                           | 1016.8                 | 64.1                 | 0.1                    | defective             | 0.0                   |
| 276 | 9/13/2009 |                  | 12.9                           | 1011.7                 | 77.1                 | 0.8                    | defective             | 1.2                   |
| 277 | 9/14/2009 |                  | 13.2                           | 1009.2                 | 76.8                 | 0.7                    | defective             | 6.8                   |
| 278 | 9/15/2009 |                  | 15.4                           | 1008.4                 | 76.4                 | 0.0                    | defective             | 0.0                   |
| 279 | 9/16/2009 |                  | 17.2                           | 1007.2                 | 71.9                 | 0.2                    | defective             | 0.0                   |
| 280 | 9/17/2009 |                  | 14.6                           | 1010.2                 | 70.1                 | 0.0                    | defective             | 0.0                   |
| 281 | 9/18/2009 |                  | 18.0                           | 1008.2                 | 68.1                 | 0.0                    | defective             | 0.0                   |
| 282 | 9/19/2009 |                  | 19.7                           | 1007.3                 | 70.0                 | 0.0                    | defective             | 0.0                   |
| 283 | 9/20/2009 |                  | 18.7                           | 1012.3                 | 72.3                 | 0.0                    | defective             | 0.0                   |
| 284 | 9/21/2009 |                  | 14.9                           | 1016.8                 | 71.4                 | 0.0                    | defective             | 0.0                   |
| 285 | 9/22/2009 |                  | 16.9                           | 1016.5                 | 64.3                 | 0.0                    | defective             | 0.0                   |
| 286 | 9/23/2009 |                  | 17.4                           | 1016.4                 | 70.9                 | 0.0                    | defective             | 0.0                   |
| 287 | 9/24/2009 |                  | 13.8                           | 1015.9                 | 79.1                 | 0.0                    | defective             | 0.6                   |
| 288 | 9/25/2009 |                  | 13.2                           | 1017.9                 | 69.2                 | 0.0                    | defective             | 0.0                   |
| 289 | 9/26/2009 |                  | 13.7                           | 1017.5                 | 65.9                 | 0.0                    | defective             | 0.0                   |
| 290 | 9/27/2009 |                  | 14.2                           | 1017.1                 | 66.9                 | 0.0                    | defective             | 0.0                   |
| 291 | 9/28/2009 |                  | 14.7                           | 1014.5                 | 69.6                 | 0.0                    | defective             | 0.0                   |
| 292 | 9/29/2009 |                  | 15.7                           | 1011.3                 | 72.6                 | 0.0                    | defective             | 0.3                   |
| 293 | 9/30/2009 |                  | 15.5                           | 1007.7                 | 77.0                 | 0.0                    | defective             | 1.2                   |
| 294 | 10/1/2009 |                  | 12.0                           | 1007.4                 | 74.9                 | 0.1                    | defective             | 2.1                   |
| 295 | 10/2/2009 |                  | 10.9                           | 1008.6                 | 66.9                 | 0.0                    | defective             | 0.0                   |
| 296 | 10/3/2009 |                  | 13.4                           | 1002.1                 | 63.9                 | 0.5                    | defective             | 0.0                   |
| 297 | 10/4/2009 |                  | 11.8                           | 1005.3                 | 75.4                 | 0.4                    | defective             | 3.3                   |
| 298 | 10/5/2009 |                  | 13.1                           | 1003.9                 | 80.0                 | 0.8                    | defective             | 6.5                   |
| 299 | 10/6/2009 |                  | 15.9                           | 1003.5                 | 82.3                 | 0.0                    | defective             | 10.3                  |
| 300 | 10/7/2009 |                  | 19.2                           | 1000.6                 | 75.9                 | 0.1                    | defective             | 8.6                   |

**Annex 6**

**Ambient conditions at the field test sites**

| No. | Date       | Test site          | Amb. temperature (avg)<br>[°C] | Amb. pressure<br>[hPa] | Rel. humidity<br>[%] | Wind velocity<br>[m/s] | Wind direction<br>[°] | Precipitation<br>[mm] |
|-----|------------|--------------------|--------------------------------|------------------------|----------------------|------------------------|-----------------------|-----------------------|
| 301 | 10/8/2009  | Bomheim, Summer    | 10.7                           | 1009.6                 | 78.6                 | 0.4                    | defective             | 0.0                   |
| 302 | 10/9/2009  |                    | 12.1                           | 1008.9                 | 69.1                 | 0.2                    | defective             | 12.4                  |
| 303 | 10/10/2009 |                    | 13.2                           | 1005.2                 | 80.0                 | 0.2                    | defective             | 4.2                   |
| 304 | 10/11/2009 |                    | 11.9                           | 1002.7                 | 76.1                 | 0.8                    | defective             | 5.9                   |
| 305 | 10/12/2009 |                    | 9.8                            | 1014.3                 | 70.9                 | 1.9                    | defective             | 2.1                   |
| 306 | 10/13/2009 |                    | 7.4                            | 1019.5                 | 68.5                 | 0.7                    | defective             | 0.0                   |
| 307 | 10/14/2009 |                    | 3.3                            | 1021.8                 | 67.4                 | 0.1                    | defective             | 0.0                   |
| 308 | 10/15/2009 |                    | 5.4                            | 1018.6                 | 66.9                 | 0.3                    | defective             | 0.3                   |
| 309 | 10/16/2009 |                    | 8.8                            | 1012.5                 | 70.8                 | 4.4                    | defective             | 1.5                   |
| 310 | 10/17/2009 |                    | 7.2                            | 1014.4                 | 69.7                 | 1.1                    | defective             | 0.0                   |
| 311 | 10/18/2009 |                    | 5.5                            | 1014.0                 | 73.1                 | 0.0                    | defective             | 0.0                   |
| 312 | 10/19/2009 |                    | 5.6                            | 1007.6                 | 66.3                 | 0.2                    | defective             | 0.0                   |
| 313 | 10/20/2009 |                    | 7.8                            | 998.9                  | 61.4                 | 4.2                    | defective             | 0.0                   |
| 314 | 10/21/2009 |                    | 10.0                           | 994.7                  | 57.1                 | 1.5                    | defective             | 1.2                   |
| 315 | 10/22/2009 |                    | 8.7                            | 996.5                  | 73.5                 | 0.0                    | defective             | 0.0                   |
| 316 | 12/9/2009  | Teddington, Winter | 9.8                            | 1016.5                 | 94.1                 | 0.1                    | 221.3                 | 0.3                   |
| 317 | 12/10/2009 |                    | 3.9                            | 1028.0                 | 90.9                 | 0.2                    | 244.4                 | 0.3                   |
| 318 | 12/11/2009 |                    | 5.7                            | 1028.7                 | 93.8                 | 0.4                    | 231.1                 | 0.0                   |
| 319 | 12/12/2009 |                    | 5.8                            | 1026.3                 | 83.9                 | 0.8                    | 200.2                 | 0.0                   |
| 320 | 12/13/2009 |                    | 4.2                            | 1021.8                 | 87.7                 | 0.5                    | 234.4                 | 0.3                   |
| 321 | 12/14/2009 |                    | 3.4                            | 1016.8                 | 88.8                 | 0.2                    | 201.3                 | 0.0                   |
| 322 | 12/15/2009 |                    | -0.6                           | 1015.4                 | 87.5                 | 0.2                    | 196.0                 | 0.3                   |
| 323 | 12/16/2009 |                    | 1.5                            | 1006.0                 | 96.9                 | 0.2                    | 244.7                 | 2.8                   |
| 324 | 12/17/2009 |                    | 1.3                            | 1007.7                 | 85.2                 | 2.4                    | 225.4                 | 1.3                   |
| 325 | 12/18/2009 |                    | -0.8                           | 1012.7                 | 86.6                 | 0.9                    | 281.2                 | 0.0                   |
| 326 | 12/19/2009 |                    | -0.1                           | 1002.1                 | 85.9                 | 0.2                    | 240.4                 | 1.8                   |
| 327 | 12/20/2009 |                    | -0.9                           | 995.4                  | 87.3                 | 0.1                    | 206.2                 | 0.0                   |
| 328 | 12/21/2009 |                    | 1.1                            | 983.8                  | 97.3                 | 0.3                    | 187.2                 | 8.6                   |
| 329 | 12/22/2009 |                    | -2.1                           | 987.9                  | 98.3                 | 0.0                    | 218.1                 | 0.3                   |
| 330 | 12/23/2009 |                    | 2.8                            | 986.8                  | 95.9                 | 0.4                    | 173.5                 | 7.1                   |



**Annex 6**

**Ambient conditions at the field test sites**

| No. | Date       | Test site          | Amb. temperature (avg)<br>[°C] | Amb. pressure<br>[hPa] | Rel. humidity<br>[%] | Wind velocity<br>[m/s] | Wind direction<br>[°] | Precipitation<br>[mm] |
|-----|------------|--------------------|--------------------------------|------------------------|----------------------|------------------------|-----------------------|-----------------------|
| 331 | 12/24/2009 | Teddington, Winter | 4.1                            | 985.9                  | 94.1                 | 0.3                    | 217.3                 | 0.5                   |
| 332 | 12/25/2009 |                    | 4.1                            | 998.4                  | 94.5                 | 0.2                    | 209.5                 | 2.3                   |
| 333 | 12/26/2009 |                    | 5.9                            | 995.0                  | 90.2                 | 0.3                    | 199.7                 | 0.8                   |
| 334 | 12/27/2009 |                    | 2.4                            | 1000.0                 | 86.2                 | 0.3                    | 240.5                 | 0.0                   |
| 335 | 12/28/2009 |                    | 3.7                            | 998.2                  | 88.6                 | 1.2                    | 79.9                  | 1.8                   |
| 336 | 12/29/2009 |                    | 4.8                            | 988.0                  | 95.9                 | 1.7                    | 94.0                  | 11.7                  |
| 337 | 12/30/2009 |                    | 4.3                            | 992.3                  | 93.1                 | 1.9                    | 100.8                 | 5.6                   |
| 338 | 12/31/2009 |                    | 2.3                            | 998.1                  | 81.8                 | 1.1                    | 207.4                 | 0.0                   |
| 339 | 1/1/2010   |                    | -0.1                           | 1007.6                 | 88.3                 | 0.2                    | 242.9                 | 0.0                   |
| 340 | 1/2/2010   |                    | 1.6                            | 1016.3                 | 87.2                 | 0.1                    | 244.7                 | 0.0                   |
| 341 | 1/3/2010   |                    | -1.6                           | 1021.1                 | 88.3                 | 0.3                    | 205.4                 | 0.0                   |
| 342 | 1/4/2010   |                    | -3.7                           | 1012.0                 | 97.2                 | 0.0                    | 232.2                 | 0.0                   |
| 343 | 1/5/2010   |                    | 0.8                            | 998.1                  | 89.9                 | 0.7                    | 128.7                 | 4.8                   |
| 344 | 1/6/2010   |                    | -2.3                           | 1005.1                 | 94.3                 | 0.7                    | 215.4                 | 1.8                   |
| 345 | 1/7/2010   |                    | -1.2                           | 1013.4                 | 91.1                 | 0.5                    | 240.0                 | 0.0                   |
| 346 | 1/8/2010   |                    | -1.6                           | 1021.7                 | 91.1                 | 0.8                    | 225.0                 | 0.3                   |
| 347 | 1/9/2010   |                    | 0.9                            | 1018.0                 | 79.3                 | 1.8                    | 160.5                 | 0.0                   |
| 348 | 1/10/2010  |                    | 1.4                            | 1015.1                 | 90.5                 | 0.7                    | 91.6                  | 1.3                   |
| 349 | 1/11/2010  |                    | 1.5                            | 1014.9                 | 86.0                 | 0.3                    | 137.0                 | 0.3                   |
| 350 | 1/12/2010  |                    | 1.4                            | 999.9                  | 85.9                 | 1.5                    | 103.1                 | 0.0                   |
| 351 | 1/13/2010  |                    | 1.5                            | 998.2                  | 94.8                 | 0.1                    | 151.2                 | 8.6                   |
| 352 | 1/14/2010  |                    | 2.5                            | 1008.2                 | 97.0                 | 0.1                    | 228.7                 | 0.3                   |
| 353 | 1/15/2010  |                    | 5.6                            | 1011.4                 | 90.0                 | 1.8                    | 151.4                 | 1.8                   |
| 354 | 1/16/2010  |                    | 5.7                            | 1002.9                 | 96.3                 | 0.4                    | 201.6                 | 9.1                   |
| 355 | 1/17/2010  |                    | 4.1                            | 1018.8                 | 93.9                 | 0.1                    | 218.7                 | 0.0                   |
| 356 | 1/18/2010  |                    | 6.2                            | 1020.8                 | 97.8                 | 0.1                    | 198.8                 | 0.0                   |
| 357 | 1/19/2010  |                    | 6.4                            | 1012.3                 | 83.7                 | 1.4                    | 110.9                 | 1.0                   |
| 358 | 1/20/2010  |                    | 3.0                            | 1011.7                 | 92.1                 | 0.2                    | 227.4                 | 3.8                   |
| 359 | 1/21/2010  |                    | 6.1                            | 1014.9                 | 85.2                 | 1.1                    | 153.8                 | 0.3                   |
| 360 | 1/22/2010  |                    | 7.6                            | 1014.0                 | 95.0                 | 0.5                    | 208.9                 | 7.4                   |

Addendum to the report on performance testing, report no. 936/21209919/A of 26 March 2010 for the BAM-1020 with PM2,5 pre-separator for suspended particulate matter PM2,5 manufactured by Met One Instruments, Inc., Report No.: 936/21243375/A

**Annex 6**

**Ambient conditions at the field test sites**

| No. | Date      | Test site          | Amb. temperature (avg)<br>[°C] | Amb. pressure<br>[hPa] | Rel. humidity<br>[%] | Wind velocity<br>[m/s] | Wind direction<br>[°] | Precipitation<br>[mm] |
|-----|-----------|--------------------|--------------------------------|------------------------|----------------------|------------------------|-----------------------|-----------------------|
| 361 | 1/23/2010 | Teddington, Winter | 4.8                            | 1018.4                 | 87.0                 | 0.2                    | 262.2                 | 0.0                   |
| 362 | 1/24/2010 |                    | 4.4                            | 1022.4                 | 91.1                 | 0.1                    | 240.9                 | 1.3                   |
| 363 | 1/25/2010 |                    | 3.2                            | 1032.9                 | 80.0                 | 0.9                    | 161.2                 | 0.5                   |
| 364 | 1/26/2010 |                    | 0.0                            | 1037.1                 | 83.2                 | 0.5                    | 167.1                 | 0.0                   |
| 365 | 1/27/2010 |                    | 4.4                            | 1017.6                 | 85.5                 | 0.3                    | 247.4                 | 1.0                   |
| 366 | 1/28/2010 |                    | 5.5                            | 999.5                  | 86.4                 | 0.5                    | 246.8                 | 8.1                   |
| 367 | 1/29/2010 |                    | 1.3                            | 992.2                  | 76.9                 | 0.9                    | 279.1                 | 0.3                   |
| 368 | 1/30/2010 |                    | -0.9                           | 1001.4                 | 84.4                 | 0.2                    | 239.9                 | 0.0                   |
| 369 | 1/31/2010 |                    | 0.0                            | 1005.5                 | 91.2                 | 0.1                    | 241.4                 | 0.0                   |
| 370 | 2/1/2010  |                    | 3.1                            | 1010.5                 | 83.9                 | 0.4                    | 221.7                 | 0.3                   |
| 371 | 2/2/2010  |                    | 5.9                            | 1001.8                 | 89.6                 | 0.3                    | 229.2                 | 1.0                   |
| 372 | 2/3/2010  |                    | 6.7                            | 1004.2                 | 91.0                 | 0.2                    | 179.7                 | 2.0                   |
| 373 | 2/4/2010  |                    | 7.6                            | 997.1                  | 86.1                 | 1.3                    | 153.0                 | 2.3                   |

## Annex 2:

### Methods used for filter weighing

#### A) Sites located in Germany (Cologne and Bornheim)

##### A.1 Performance of weighing

Weighing takes place in an air-conditioned weighing chamber. Conditions are as follows: 20 °C ±1 °C and 50% ±5% rel. humidity and thus meet the requirements of EN 14907.

Filters for the field test are weighed manually. For further processing, filters incl. the control filters are placed sieves to avoid cross-loading.

Conditions for initial and back weighing had previously been defined and are in line with the standard.

| Before sampling = initial weighing       | After sampling = back weighing           |
|--|--|
| Processing 48 hours + 2 hours            | Processing 48 hours + 2 hours            |
| Filter weighing                          | Filter weighing                          |
| additional processing 24 hours + 2 hours | additional processing 24 hours + 2 hours |
| Filter weighing and immediate packaging  | Filter weighing                          |

The balance is available ready for operation at all times. The balance is calibrated before every weighing series. If everything turns out to be okay, the reference with is weighed against the calibration weight of 200 mg and peripheral parameters are recorded. Deviations from the previous weighing meet the standard's requirements and do not exceed 20 µg (see Figure 58). The six control filters are weighed this way. For control filters deviating by more than 40 µg a warning is displayed on the evaluation page. This filters are not used for back weighing. The first three flawless control filters are used for back weighing, remaining filters remain safely stored in their can to be used in the event the first three filters are damaged or experience excessive deviations. Figure 59 presents the exemplary trend over a period of four weeks.

Filters, for which there is a difference or more than 40 µg between the first and the second weighing, are not used for initial weighing. For back weighing, filters with differences exceeding 60 µg are removed from the evaluation as required by the standard.

Addendum to the report on performance testing, report no. 936/21209919/A of 26 March 2010 for the BAM-1020 with PM<sub>2,5</sub> pre-separator for suspended particulate matter PM<sub>2,5</sub> manufactured by Met One Instruments, Inc., Report No.: 936/21243375/A

Page 151 of 160

Weighed filters are separately kept in polystyrene boxes for transports to and from the measurement site and for storage. The box is not opened until the filter is inserted in the filter cartridge. Virgin filters can be stored in the weighing chamber up to 28 days until sampling. Should this period be exceeded, initial weighing will be repeated.

Deposited filters can be stored for a maximum of 15 days at temperatures up to 23°C. Filters are stored in a fridge at 7°C.

## A2 Evaluation of the filters

Filters are evaluated using a correction term. The purpose of this corrective calculation is to minimise changes in the mass as a result of conditions in the weighing chamber.

Equation:

$$\text{Dust} = \text{MF}_{\text{rück}} - ( \text{M}_{\text{Tara}} \times ( \text{MKon}_{\text{rück}} / \text{MKon}_{\text{hin}} ) ) \quad (\text{F1})$$

$\text{MKon}_{\text{hin}}$  = mean mass of the 3 control filters determined on 48 h and 72h initial weighing

$\text{MKon}_{\text{rück}}$  = mean mass of the 3 control filters determined on 48 h and 72 h back weighing

$\text{M}_{\text{Tara}}$  = mean mass of the filter determined on 48 h and 72 h initial weighing

$\text{MF}_{\text{rück}}$  = mean mass of the filter determined on 48 h and 72 h back weighing

Dust = corrected dust load on the filter

The corrective calculation proved to render the method independent of the conditions in the weighing chamber. This way, the influence of water contents on the filter mass comparing virgin and deposited filters can be controlled and does not influence the dust concentrations deposited on the used filters. This is sufficient to meet the requirements of EN 14907, chapter 9.3.2.5.

The exemplary trend for the calibration weight for Nov 2008 to Feb 2009 shows that the permissible difference of 20 µg compared to the previous measurement is not exceeded.

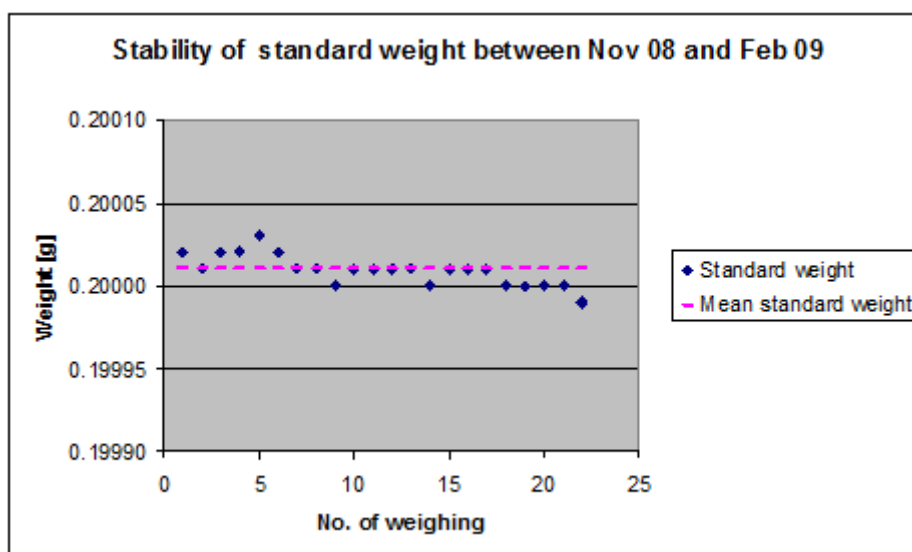

Figure 58: Stability calibration weight

Table 24: Stability calibration weight

| Date       | Weighing no. | Standard weight<br>g | Difference compared to previous weighing<br>µg |
|------------|--------------|----------------------|--|
| 12.11.2008 | 1            | 0.20002              |  |
| 13.11.2008 | 2            | 0.20001              | -10  |
| 10.12.2008 | 3            | 0.20002              | 10   |
| 11.12.2008 | 4            | 0.20002              | 0  |
| 17.12.2008 | 5            | 0.20003              | 10   |
| 18.12.2008 | 6            | 0.20002              | -10  |
| 07.01.2009 | 7            | 0.20001              | -10  |
| 08.01.2009 | 8            | 0.20001              | 0  |
| 14.01.2009 | 9            | 0.20000              | -10  |
| 15.01.2009 | 10           | 0.20001              | 10   |
| 21.01.2009 | 11           | 0.20001              | 0  |
| 22.01.2009 | 12           | 0.20001              | 0  |
| 29.01.2009 | 13           | 0.20001              | 0  |
| 30.01.2009 | 14           | 0.20000              | -10  |
| 04.02.2008 | 15           | 0.20001              | 10   |
| 05.02.2009 | 16           | 0.20001              | 0  |
| 11.02.2009 | 17           | 0.20001              | 0  |
| 12.02.2009 | 18           | 0.20000              | -10  |
| 18.02.2009 | 19           | 0.20000              | 0  |
| 19.02.2009 | 20           | 0.20000              | 0  |
| 26.02.2009 | 21           | 0.20000              | 0  |
| 27.02.2009 | 22           | 0.19999              | -10  |

Marked yellow = mean  
Marked green = lowest value  
Marked blue = highest value

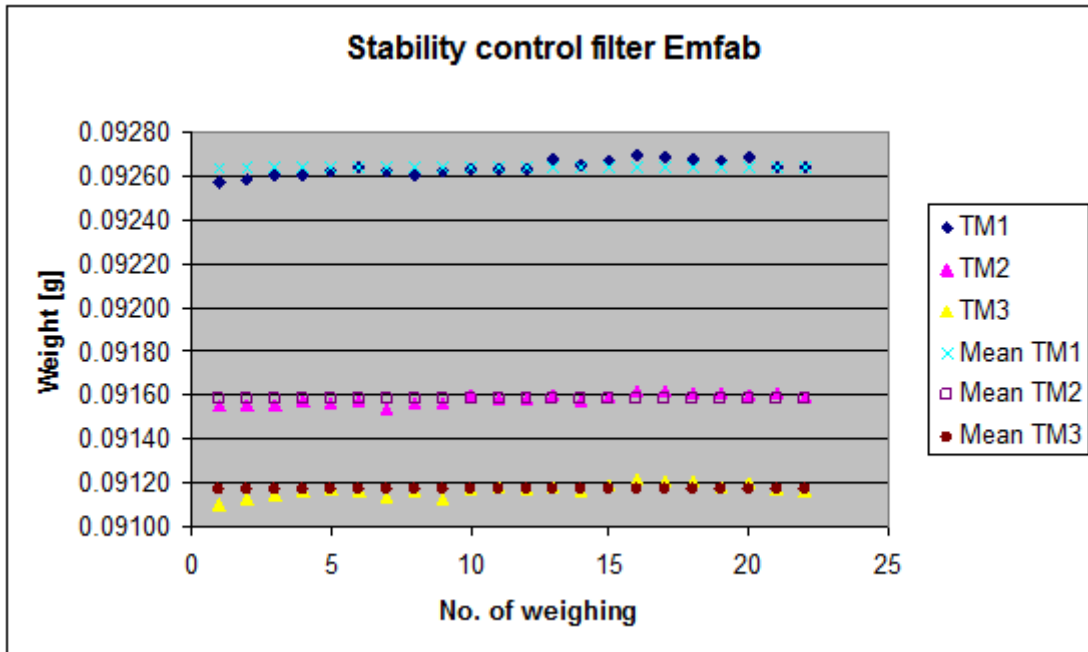

Figure 59: Stability of the control filter

Addendum to the report on performance testing, report no. 936/21209919/A of 26 March 2010 for the BAM-1020 with PM2,5 pre-separator for suspended particulate matter PM2,5 manufactured by Met One Instruments, Inc., Report No.: 936/21243375/A

Table 25: Stability of the control filters

| Weighing no.   | Control filter no. |            |            |
|----------------|--------------------|------------|------------|
|                | TM1                | TM2        | TM3        |
| 1              | 0.09257            | 0.09155    | 0.09110    |
| 2              | 0.09258            | 0.09155    | 0.09113    |
| 3              | 0.09260            | 0.09155    | 0.09115    |
| 4              | 0.09260            | 0.09157    | 0.09116    |
| 5              | 0.09262            | 0.09156    | 0.09117    |
| 6              | 0.09264            | 0.09157    | 0.09116    |
| 7              | 0.09262            | 0.09154    | 0.09114    |
| 8              | 0.09260            | 0.09156    | 0.09116    |
| 9              | 0.09262            | 0.09156    | 0.09113    |
| 10             | 0.09263            | 0.09160    | 0.09117    |
| 11             | 0.09263            | 0.09158    | 0.09118    |
| 12             | 0.09263            | 0.09158    | 0.09117    |
| 13             | 0.09267            | 0.09160    | 0.09118    |
| 14             | 0.09265            | 0.09157    | 0.09116    |
| 15             | 0.09266            | 0.09159    | 0.09119    |
| 16             | 0.09269            | 0.09162    | 0.09122    |
| 17             | 0.09268            | 0.09162    | 0.09121    |
| 18             | 0.09267            | 0.09161    | 0.09121    |
| 19             | 0.09266            | 0.09161    | 0.09118    |
| 20             | 0.09268            | 0.09160    | 0.09120    |
| 21             | 0.09264            | 0.09161    | 0.09117    |
| 22             | 0.09264            | 0.09159    | 0.09116    |
|                |                    |            |            |
|                |                    |            |            |
| Average        | 0.09264            | 0.09158    | 0.09117    |
| Standard dev.  | 3.2911E-05         | 2.4937E-05 | 2.8558E-05 |
| rel. Std. dev. | 0.036              | 0.027      | 0.031      |
|                |                    |            |            |
| Median         | 0.09264            | 0.09158    | 0.09117    |
| lowest value   | 0.09257            | 0.09154    | 0.09110    |
| highest value  | 0.09269            | 0.09162    | 0.09122    |

Marked yellow = mean

Marked green = lowest value

Marked blue = highest value



## B) Site in the United Kingdom (Teddington)

### B.1 Implementation of weighing protocols

NPL (National Physical Laboratory) was commissioned to weigh filters for the field test manually. In compliance with EN 14907, the filter was stored in the weighing chamber for less than 28 days. The Plexiglas chamber used for weighing was kept at  $20 \pm 1^\circ\text{C}$  and  $50 \pm 5\%$ . Filters were weighed twice each before and after sampling. Table 26 summarises weighing conditions and weighing times.

Table 26: Weighing conditions and weighing times

| Pre Sampling                                   | Post Sampling                       |
|--|-------------------------------------|
| Condition minimum of 48 hours<br>Weigh Filters | Condition 48 hours<br>Weigh Filters |
| Condition 24 hours<br>Weigh Filters            | Condition 24 hours<br>Weigh Filters |

The beam balance was checked before every weighing series in order to remove mechanical rigidity. Calibration took place after that. At the beginning and the end of every filter lot, a 50 mg and a 200 mg reference weight were weighed. In accordance with the UK PM Equivalence Report [8], the filter was weighed against a 100 mg reference weight rather than against a zero filter since the latter experiences weight loss over time. Four filters each were weighed between the reference weights, since the weighing drift over this period is small.

The **mass of the reference weight (CM)** for the filters was calculated for each weighing series according to equation **E A.1**.

$$CM = \frac{(m_{check,Beg} + m_{check,End})}{2} \quad \text{E A.1}$$

Where:

$M_{check,Beg}$  = mass of the reference weight, weighed just upstream of the sampling filter.

$M_{check,End}$  = mass of the reference filter, weighed just downstream of the sampling filter.

The **relative mass (RM)** of the filters was determined for every weighing series in accordance with equation **E A.2**.  $RM = m_{filter} - CM$  **E A.2**

Where:

$m_{filter}$  = mass of the sampling filter

EN 14907 defines the **particle mass (PM)** as calculated in accordance with the following equation:

$$PM = \left( \frac{RM_{End1} + RM_{End2}}{2} \right) - \left( \frac{RM_{Beg1} + RM_{Beg2}}{2} \right) \quad \text{E A.3}$$

Where:

Beg1 marks weighing series 1 before sampling

Beg2 marks weighing series 2 before sampling

End1 marks weighing series 1 after sampling

End2 marks weighing series 2 after sampling



**End scattering range ( $S_{Pre}$ ), Beg scattering range ( $S_{Post}$ ) and reference weight scattering range ( $S_{Blank}$ )** were calculated according to the following equation:

$$S_{Pre} = RM_{Anf1} - RM_{Anf2} \quad \text{E A.4}$$

$$S_{Post} = RM_{End1} - RM_{End2} \quad \text{E A.5}$$

$$S_{Blank} = \left( \frac{CM_{End2} + CM_{End1}}{2} \right) - \left( \frac{CM_{Anf2} + CM_{Anf1}}{2} \right) \quad \text{E A.6}$$

As described in the UK PM Equivalence Report [8], it was not possible to weigh all filters within the 15-day period as required by EN 14907.

However, the filters were immediately taken from the reference sampler to be put in the fridge which is why it was unnecessary to establish whether  $T_{Umgebung}$  exceeded 23°C. 15 days appear unfeasible for a relatively small field test scope. The method is unlikely to be copied in national or regional grids. The method used here is representative of the operation of the reference sampler in practice.

## **A.2 Analysis of the weighing protocol used**

Figure 60 presents the scattering behaviour of the initial and back weighing for all EMFAB filters collected referred to the carrying weight and the reference weight. If all filters lose relative weight, scattering shifts to the right. Conversely, scattering will shift left if the filters increase in mass. Standard EN 14907 requires undeposited filters to be discarded if the mass difference between the two initial weighings exceeds 40 µg. By the same token, EN 14907 requires filters to be discarded if the difference between the two back weighings exceeds 60 µg. This criterion did not result in any filters being discarded. It is considered unlikely that the defined scattering of repeated mass determinations significantly affect the results.

Figure 60: Scattering of the EMFAB filter for (A) initial weighing compared to the reference weight and (B) back weighing compared to the reference weight.

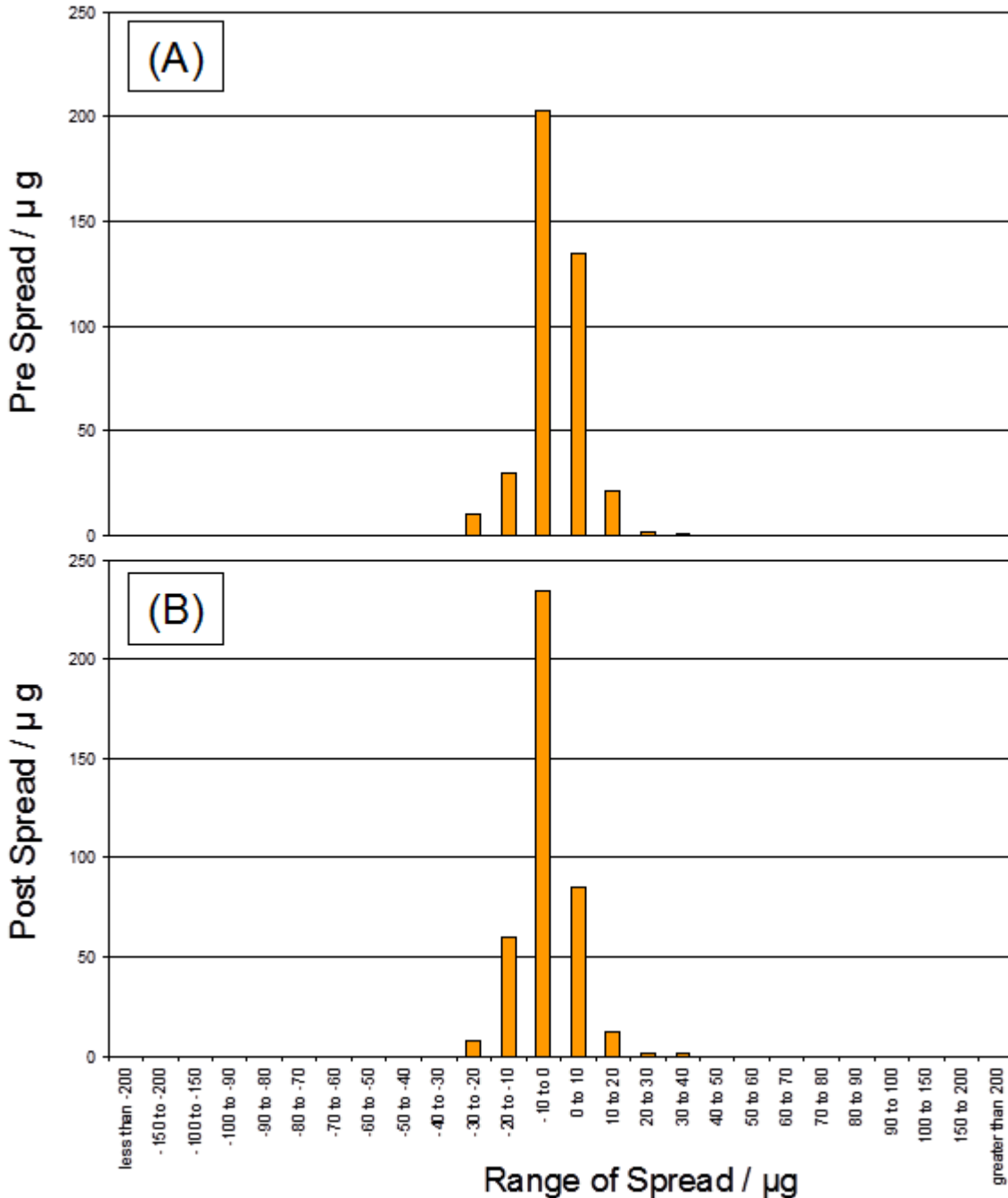

Addendum to the report on performance testing, report no. 936/21209919/A of 26 March 2010 for the BAM-1020 with PM<sub>2,5</sub> pre-separator for suspended particulate matter PM<sub>2,5</sub> manufactured by Met One Instruments, Inc., Report No. 936/21243375/A

## **Annex 3:**

### **Manual**

**APDA-371  
PARTICULATE MONITOR  
OPERATION MANUAL**

## Table of Contents

|          |  |           |
|----------|--|-----------|
| <b>1</b> | <b>INTRODUCTION</b>  | <b>4</b>  |
| 1.1      | About This Manual.....   | 4         |
| 1.2      | Technical Service .....  | 4         |
| 1.3      | Beta Attenuation Monitor .....   | 4         |
| 1.4      | Beta Radiation Safety Statement .....                                  | 5         |
| 1.5      | Model APDA-371 PM <sub>10</sub> USEPA Equivalent Method .....          | 5         |
| 1.6      | Model APDA-371 PM <sub>2.5</sub> USEPA Equivalent Method .....         | 6         |
| 1.7      | APDA-371 Specifications .....  | 7         |
| <b>2</b> | <b>SITE SELECTION AND INSTALLATION</b>                                 | <b>8</b>  |
| 2.1      | Unpacking and Inspection .....   | 8         |
| 2.2      | Installation .....   | 8         |
| 2.3      | Site Selection .....   | 9         |
| 2.4      | Mounting Options in a Walk-In Shelter .....                            | 10        |
| 2.5      | Installation Instructions in a Walk-In Shelter .....                   | 12        |
| 2.6      | Electrical Connections .....   | 21        |
| <b>3</b> | <b>INITIAL SETUP OF YOUR APDA-371</b>                                  | <b>23</b> |
| 3.1      | Power Up.....  | 23        |
| 3.2      | Warm-up.....   | 24        |
| 3.3      | Using the Keypad and Display .....                                     | 24        |
| 3.4      | Filter Tape Loading.....   | 26        |
| 3.5      | Self-Test.....   | 28        |
| 3.6      | Initial SETUP Settings Considerations .....                            | 29        |
| 3.7      | Initial Leak Check and Flow Check.....                                 | 29        |
| 3.8      | Starting a Measurement Cycle .....                                     | 29        |
| 3.9      | The Flow Statistics Screen .....                                       | 30        |
| 3.10     | The OPERATE Menus .....  | 31        |
| 3.11     | The NORMAL Screen.....   | 31        |
| 3.12     | The INSTANTANEOUS Screen .....   | 32        |
| 3.13     | The AVERAGE Screen.....  | 32        |
| <b>4</b> | <b>THE MEASUREMENT CYCLE</b>   | <b>33</b> |
| 4.1      | The One-Hour Cycle Timeline .....                                      | 33        |
| 4.2      | Automatic Span Check During The Cycle .....                            | 34        |
| 4.3      | Sample Period Description .....  | 35        |
| 4.4      | Filter Tape Use.....   | 35        |
| <b>5</b> | <b>FLOW SYSTEM and FLOW CALIBRATIONS</b>                               | <b>36</b> |
| 5.1      | Flow System Diagram .....  | 36        |
| 5.2      | Flow rate control .....  | 37        |
| 5.3      | Flow Control and Flow Reporting Types – Standard or Actual Flow .....  | 37        |
| 5.4      | Total Flow (Q <sub>TOT</sub> ) and Flow Rate (LPM) Conversions .....   | 38        |
| 5.5      | About Leak Checks, Nozzle Cleaning and Flow Checks .....               | 38        |
| 5.6      | Leak Check Procedure .....   | 39        |
| 5.7      | Nozzle and Vane Cleaning Procedure.....                                | 40        |
| 5.8      | Field Calibration of Flow System – Actual (Volumetric) Flow Mode ..... | 42        |
| 5.9      | Field Calibration of Flow System – Standard Flow Mode .....            | 44        |
| <b>6</b> | <b>SETUP MENU DESCRIPTIONS</b>   | <b>45</b> |
| 6.1      | CLOCK Setup Screen .....   | 46        |
| 6.2      | SAMPLE Setup Screen – Important Information .....                      | 46        |
| 6.3      | CALIBRATE Setup Screen – Important Information .....                   | 48        |
| 6.4      | EXTRA1 Setup Screen.....   | 50        |
| 6.5      | ERRORS Setup Screen for the Analog Output .....                        | 51        |
| 6.6      | PASSWORD Setup Screen.....   | 52        |

|           |   |            |
|-----------|---|------------|
| 6.7       | INTERFACE Setup Screen .....  | 53         |
| 6.8       | SENSOR Setup Screen.....  | 54         |
| 6.9       | HEATER Setup Screen .....   | 55         |
| 6.10      | QUERY Setup Screen – Custom Data Array Setup .....                    | 57         |
| 6.11      | REPORTS Setup Screen – Daily Data and Dynamic Ranges.....             | 58         |
| 6.12      | HJ 653 Setup Screen – Chinese Data Formatting.....                    | 60         |
| <b>7</b>  | <b>MAINTENANCE, DIAGNOSTICS and TROUBLESHOOTING</b>                   | <b>61</b>  |
| 7.1       | HORIBA Suggested Periodic Maintenance .....                           | 61         |
| 7.2       | APDA-371 Error and Alarm Descriptions.....                            | 62         |
| 7.3       | Comparison of APDA-371 Data to Integrated Filter Sampler Data.....    | 64         |
| 7.4       | Audit Sheet and Test Records.....                                     | 65         |
| 7.5       | Self-Test Feature.....  | 65         |
| 7.6       | Power-Up Problems and Electrical Safety Considerations.....           | 66         |
| 7.7       | Basic Problem and Cause/Solution Table .....                          | 67         |
| 7.8       | Nozzle Component Replacement.....                                     | 70         |
| 7.9       | Performing the 72-Hour Zero Filter Background Test.....               | 72         |
| 7.10      | TEST Menu System .....  | 74         |
| 7.11      | COUNT Test Menu.....  | 74         |
| 7.12      | PUMP Test Menu .....  | 75         |
| 7.13      | TAPE Test Menu .....  | 75         |
| 7.14      | DAC Test Menu – Analog Output Test .....                              | 76         |
| 7.15      | CALIBRATE Test Menu.....  | 76         |
| 7.16      | INTERFACE Test Menu .....   | 77         |
| 7.17      | FLOW Test Menu .....  | 77         |
| 7.18      | ALIGN Test Menu – Photo Sensor Tests .....                            | 77         |
| 7.19      | HEATER Test Menu.....   | 78         |
| 7.20      | FILTER-T Test Menu – Filter Temperature Sensor Test .....             | 79         |
| 7.21      | RH Test Menu – Filter Humidity Sensor and Calibration .....           | 79         |
| <b>8</b>  | <b>EXTERNAL DATALOGGER INTERFACE SYSTEM</b>                           | <b>81</b>  |
| 8.1       | Analog Concentration Output Signal .....                              | 81         |
| 8.2       | Early Cycle Mode Description .....                                    | 82         |
| 8.3       | Telemetry and Error Relays.....                                       | 83         |
| 8.4       | Digital Datalogger Interfacing with the APDA-371 .....                | 86         |
| <b>9</b>  | <b>RS-232 SERIAL COMMUNICATIONS – DATA RETRIEVAL</b>                  | <b>87</b>  |
| 9.1       | Direct Serial Port Connections and Settings.....                      | 87         |
| 9.2       | HORIBA Communications Software.....                                   | 88         |
| 9.3       | Downloading Data Using Simple Terminal Programs.....                  | 89         |
| 9.4       | System Menu and File Descriptions using a Terminal Program .....      | 90         |
| 9.5       | Printer Output Port.....  | 97         |
| 9.6       | Modem Option.....   | 97         |
| 9.7       | APDA-371 Firmware Upgrades .....                                      | 98         |
| 9.8       | Resetting the Data Pointer for New Data Collection.....               | 99         |
| 9.9       | Data Collection Using the Query Output or Bayern-Hessen Protocol..... | 100        |
| <b>10</b> | <b>ACCESSORIES and PARTS</b>  | <b>102</b> |
| 10.1      | Consumables, Replacement Parts, and Accessories.....                  | 102        |
| 10.2      | BX-500 Series Sensor Configurations.....                              | 106        |
| <b>11</b> | <b>THEORY OF OPERATION and MATHEMATICAL ANALYSIS</b>                  | <b>109</b> |
| 11.1      | Converting Data Between EPA Standard and Actual Conditions .....      | 110        |
|           | <b>APDA-371 Audit Sheet Sample</b>                                    | <b>112</b> |



# 1 INTRODUCTION



## 1.1 About This Manual

This document is organized with the most important information toward the front of the manual, such as site selection, installation, setups, and field calibrations.

Sections and sub-sections marked with an Information Symbol  contain critical information which all APDA-371 owners and operators should read and understand. Toward the back are sections that provide in-depth information on subjects such as theory, diagnostics, accessories, and alternate settings. These sections provide valuable information which should be consulted as needed. Electronic versions of this manual are also available.

## 1.2 Technical Service

This manual is structured by customer feedback to provide the required information for setup, operation, testing, maintaining, and troubleshooting your APDA-371 unit. Should you still require support after consulting your printed documentation, we encourage you to contact one of our expert Technical Service representatives during normal business hours of 7:00 a.m. to 4:00 p.m.

Phone: +49 (0)2175 – 8978-0  
Fax: +49 (0)2175 – 8978-50  
E-Mail: [info@HORIBA.com](mailto:info@HORIBA.com)

Postal address: HORIBA Europe GmbH  
Julius-Kronenberg-Str. 9  
42799 LEICHLINGEN  
GERMANY

## 1.3 Beta Attenuation Monitor

The HORIBA model APDA-371 automatically measures and records airborne particulate concentration levels using the principle of beta ray attenuation. This method provides a simple determination of concentration in units of milligrams or micrograms of particulate per cubic meter of air. A small <sup>14</sup>C (Carbon 14) element emits a constant source of high-energy electrons known as beta particles. These beta particles are detected and counted by a sensitive scintillation detector. An external pump pulls a measured amount of dust-laden air through a filter tape. After the filter tape is loaded with ambient dust, it is automatically placed between the source and the detector thereby causing an attenuation of the beta particle signal. The degree of attenuation of the beta particle signal is used to determine the mass concentration of particulate matter on the filter tape, and hence the volumetric concentration of particulate matter in ambient air. A complete description of the measurement cycle is included in Section 4. In addition, an in-depth scientific explanation of the theory of operation and the related equations is included toward the back of the manual.

## 1.4 Beta Radiation Safety Statement

The HORIBA APDA-371 contains a small  $^{14}\text{C}$  (Carbon 14) beta radiation-emitting source. The activity of the source is **60**  $\mu\text{Ci} \pm 15\% \text{ Ci}$  (microcurries), which is below the “Exempt Concentration Limit” as defined in 10 CFR Section 30.70 – Schedule A. The owner of a APDA-371 is not required to obtain any license in the United States to own or operate the unit. The owner of a APDA-371 may elect to return the entire unit to HORIBA for recycling of the  $^{14}\text{C}$  source when the unit has reached the end of its service life, although the owner is under no obligation to do so. Under no circumstances should anyone but factory technicians attempt to remove or access the beta source. The beta source has a half-life of about 5730 years, and should never need to be replaced. Neither the  $^{14}\text{C}$  source nor the beta particle detector are serviceable in the field. Should these components require repair or replacement, the APDA-371 must be returned to the factory for service and recalibration.

## 1.5 Model APDA-371 PM<sub>10</sub> USEPA Equivalent Method

The HORIBA APDA-371 is designated as an equivalent method for PM<sub>10</sub> monitoring by the United States Environmental Protection Agency on August 3, 1998.

Designation Number: **EQPM-0798-122**

The EPA designation applies to G, -1, G-1, and later APDA-371 PM<sub>10</sub> Beta Attenuation Monitors, when used in conjunction with the following requirements. Users are advised that configurations that deviate from this specific description may not meet the applicable requirements of 40 CFR Parts 50 and 53.

- The APDA-371 is operated to obtain a daily average of the hourly measurements, with a filter change frequency of one hour.
- The inlet must be equipped with the standard BX-802 EPA PM<sub>10</sub> inlet head.
- The unit must be used with standard glass fiber filter tape.
- The unit may be operated with or without any of the following options: BX-823 inlet tube extension, BX-825 heater kit, BX-826 230V heater kit, BX-828 roof tripod, BX-902 exterior enclosure, BX-903 exterior enclosure with temperature control, BX-961 mass flow controller, BX-967 internal calibration device.
- The SAMPLE TIME parameter must be set for 50 minutes.

## 1.6 Model APDA-371 PM<sub>2.5</sub> USEPA Equivalent Method

The HORIBA Europe GmbH Model APDA-371 Beta Attenuation Mass Monitor - PM<sub>2.5</sub> FEM Configuration, is designated as an equivalent method for PM<sub>2.5</sub> monitoring in accordance with 40 CFR Part 53 by the United States Environmental Protection Agency as of March 12, 2008.

Designation Number: **EQPM-0308-170**

All of the following parameters and conditions must be observed when the APDA-371 is operated as a PM<sub>2.5</sub> FEM particulate monitor:

- The inlet must be equipped with an EPA-designated PM<sub>2.5</sub> Very Sharp Cut Cyclone (VSCC™-A by BGI, Inc.). The HORIBA stock number for the VSCC™ is BX-808.
- The inlet must be equipped with a standard EPA PM<sub>10</sub> inlet head. HORIBA BX-802.
- The unit is operated for hourly average measurements. The PM<sub>2.5</sub> concentration is calculated (external to the APDA) as a daily average of the hourly concentration measurements made by the APDA-371.
- The unit must be equipped with firmware revision 3.2.4 or later.
- The APDA-371 must be operated in proper accordance with this operation manual, revision F or later. A supplemental BGI Inc. manual is also supplied with the VSCC™.
- The unit must be equipped with a BX-596 ambient temperature and barometric pressure combination sensor. This is used for flow control and flow statistics.
- The unit must be equipped with the internal BX-961 automatic flow controller, and must be operated in Actual (volumetric) flow control mode.
- The unit must be equipped with a BX-827 (110V) or BX-830 (230V) Smart Inlet Heater, with the heater RH regulation set point set to 35%, and Delta-T control disabled.
- The unit must be equipped with the 8470-1 rev D or later tape control transport assembly with close geometry beta source configuration. All APDA-371 units manufactured after March 2007 have these features standard. Older units will have to be factory upgraded and re-calibrated to the latest specifications.
- The unit must be operated with standard glass fiber filter tape.
- The COUNT TIME parameter must be set for 8 minutes.
- The SAMPLE TIME parameter must be set for 42 minutes.
- The BX-302 zero filter calibration kit is a required accessory. This kit must be used to audit the BKGD (background) value upon unit deployment and periodically thereafter, as described in the BX-302 manual.
- The unit may be operated with or without a BX-823 eight foot inlet tube extension and with or without weatherproof outdoor enclosures BX-902 or BX-903.

## 1.7 APDA-371 Specifications

| PARAMETER                                    | SPECIFICATION   |
|--|---|
| <b>Measurement Principle:</b>                | Particulate Concentration by Beta Attenuation.  |
| <b>US-EPA Existing Designations:</b>         | PM <sub>10</sub> : EPA EQPM-0798-122<br>PM <sub>2.5</sub> : Class III EPA EQPM-0308-170   |
| <b>EN Approvals (QAL1)</b>                   | PM <sub>10</sub> : Certificate No.: 0000039317 (TÜV Rheinland / German Federal Environment Agency)<br>PM <sub>2.5</sub> : Certificate No.: 0000027277 (TÜV Rheinland / German Federal Environment Agency) |
| <b>Standard Range:</b>                       | 0 - 1.000 mg/m <sup>3</sup> (0 - 1000 $\bar{g}/m^3$ )   |
| <b>Optional Ranges:</b>                      | 0 - 0.100, 0.200, 0.250, 0.500, 2.000, 5.000, 10.000 mg/m <sup>3</sup> (special applications)   |
| <b>Accuracy:</b>                             | Exceeds US-EPA Class III PM <sub>2.5</sub> FEM standards for additive and multiplicative bias.  |
| <b>Resolution:</b>                           | ± 0.1 µg/m <sup>3</sup>   |
| <b>Lower Detection Limit: (2σ) (1 hour)</b>  | Less than 4.8 µg/m <sup>3</sup> (less than 4.0 µg/m <sup>3</sup> typical) (8-min Count time)  |
| <b>Lower Detection Limit: (2σ) (24 hour)</b> | Less than 1.0 µg/m <sup>3</sup>   |
| <b>Measurement Cycle Time:</b>               | 1 Hour  |
| <b>Flow Rate:</b>                            | 16.7 liters/minute. Adjustable 0-20 LPM range. Actual or Standard flow.   |
| <b>Filter Tape:</b>                          | Continuous glass fiber filter, 30mm x 25m roll. > 60 days/roll with 1h-cycle time.  |
| <b>Span Check:</b>                           | Automatic 800ug (typical) span foil verified hourly.  |
| <b>Beta Source:</b>                          | <sup>14</sup> C (carbon-14), 60 µCi ±15 µCi (< 2.22 X 10 <sup>6</sup> Beq), Half-Life 5730 years.   |
| <b>Beta Detector Type:</b>                   | Photomultiplier tube with organic plastic scintillator.   |
| <b>Operating Temp. Range:</b>                | 0 to +50°C (+5°C to +40°C according to EN-Approval)   |
| <b>Ambient Temp. Range:</b>                  | -30° to +60°C   |
| <b>Ambient Humidity Range:</b>               | 0 to 90% RH, non-condensing.  |
| <b>Humidity Control:</b>                     | Actively controlled inlet heater module, 10 - 99% RH set point.   |
| <b>Approvals:</b>                            | US-EPA, CE, NRC, TUV, CARB, ISO-9001  |
| <b>User Interface:</b>                       | Menu-driven interface with 8x40 character LCD display and dynamic keypad.   |
| <b>Analog Output:</b>                        | Isolated 0-1 VDC output standard. 0-10V, 4-20mA, 0-16mA switch-selectable.  |
| <b>Serial Interface:</b>                     | RS-232 2-way serial port for PC or modem communications.  |
| <b>Printer Output:</b>                       | Output-only serial port, data or diagnostic output to a PC or serial printer.   |
| <b>Telemetry Inputs:</b>                     | Clock Reset (voltage or contact closure), Telemeter Fault (contact closure).  |
| <b>Alarm Contact Closures:</b>               | Data Error, Tape Fault, Flow Error, Power Failure, Maintenance.   |
| <b>Compatible Software:</b>                  | Luft Plus™, Comet™, MicroMet Plus®, HyperTerminal®, ProComm Plus®.  |
| <b>Error Reporting:</b>                      | User-configurable. Available through serial port, display, and relay outputs.   |
| <b>Memory:</b>                               | 4369 records (182 days @ 1 record/hr).  |
| <b>Power Supply:</b>                         | 100 - 230 VAC, 50/60 Hz. 0.4 kW 3.4A max.   |
| <b>Weight:</b>                               | 24.5 kg (54 lbs) without external accessories.  |
| <b>Unit Dimensions:</b>                      | H x W x D = 31cm x 43cm x 40cm (12.25" x 17" x 16").  |

\*Specifications may be subject to change without notice.

## 2 SITE SELECTION AND INSTALLATION



### 2.1 Unpacking and Inspection

If any damage to the shipment is noticed **before** unpacking, a claim must be filed with the commercial carrier immediately. Notify HORIBA after notification of the commercial carrier.

Remove the unit and accessories from the shipping boxes and compare the received items to the packing list. Make sure you have all of the required items for the type of installation you plan to perform.

The APDA-371 is shipped with two white foam rings and a white plastic shim inside the front of the unit, which prevent the moving parts of the tape control assembly from being damaged in transit. Do not remove the foam rings until the APDA-371 is ready to be installed. These rings must be replaced anytime the unit is being transported in order to avoid damaging the tape control mechanism.

Please keep the special box and foam packing material that the APDA-371 was shipped in, to re-use in the event that you must return the unit to the factory. HORIBA is not responsible for any damages to the unit if returned in non-original packaging, or without the foam rings in place. Contact HORIBA for replacement packing materials if necessary.

### 2.2 Installation

The APDA-371 unit is not weatherproof or water resistant, and is designed to be mounted in a weatherproof, level, vibration free, dust free, and temperature controlled environment where the operating temperature is between 0°C and +50°C (+5°C to +40°C according to EN-Approval), and where the relative humidity is non-condensing and does not exceed 90%. There are two standard configurations described below for providing a weatherproof location in which to install the unit. Please contact HORIBA if you plan to have a non-standard mounting or enclosure configuration.

1. **A walk-in building or mobile shelter with a flat roof:** This is often a pre-fabricated shelter, a trailer shelter, or a room in an existing permanent building. The APDA is mounted on a bench-top or in an equipment rack, often with a variety of other instruments installed in the same shelter. The inlet tube of the APDA must extend up through the roof with appropriate hardware. AC power must be available. Instructions for this type of installation are included in this section of the manual.
2. **BX-902/903 environmentally controlled mini enclosure:** These small pre-fabricated enclosures are just big enough for the APDA and related accessories, and are installed on the ground or on the roof of a larger building. They are available with a heater (BX-902), or with a heater and air conditioner (BX-903). These enclosures are custom designed by HORIBA to accept the APDA-371, and are supplied with a supplemental setup and installation manual.

**Shelter Temperature Control NOTES:** The air temperature inside a APDA-371 shelter or enclosure is not required to be regulated to any specific narrow range or set point (such as 25 °C), subject to the following caveats:

1. The shelter temperature must stay between 0 and 50 °C (+5°C to +40°C according to EN-Approval) inside at all times or alarms and failures may result. Remember that the vacuum pump and inlet heater can contribute significantly to shelter heating.
2. The exact shelter temperature within the 0-50 °C range (+5°C to +40°C according to EN-Approval) is not critical. However temperature changes during the measurement cycle can lead to measurement artifacts. These artifacts, when present tend to present only during hourly measurements and are generally insignificant when daily averages are calculated.
3. HORIBA recommends logging the temperature inside non-air conditioned mini enclosures such as the model BX-902.
4. APDA-371 users in hot climates where the ambient temperature exceeds 40 °C should consider using the model BX-903 air conditioned mini shelter or an air conditioned walk-in shelter to avoid over-heating the APDA-371.
5. The portion of the inlet tube inside of the shelter or building should always be adequately insulated. This is especially important when the equipment is operated under conditions of high ambient dew point. Otherwise condensation could occur inside the sampling tube and/or measurement artifacts could result. If this proves to be an issue, the user may consider increasing the temperature inside the shelter to a point closer to ambient temperature. The APDA-371 should not be placed directly in the path on an air conditioning vent.

## **2.3 Site Selection**

Selection of a proper site for the APDA-371 is critical for accurate measurements. In many cases, these items must be correctly addressed in order for the collected data to be acceptable for regulatory requirements. In any case, the Code of Federal Regulations (US) or other applicable regulatory requirements takes precedence. Such guidance and regulation may provide information concerning:

1. Inlet height
2. Spacing and clearance
3. Proximity to particulate sources, both mobile and stationary
4. Additional siting criteria or considerations

These details should be understood before selecting a site.

## 2.4 Mounting Options in a Walk-In Shelter

When the APDA-371 is to be located in a walk-in shelter, the unit will have to be installed either in an equipment rack or on a bench-top. HORIBA recommends using an equipment rack when possible, as it does a better job of keeping the unit level and in the correct placement. A rack also tends to be a cleaner installation and is more space-efficient. However, either method may be used as long as the mounting is level and allows the inlet tube to be perfectly vertical. HORIBA supplies brackets standard rack-mount screws with each unit. Take the following into account when planning your mounting:

- **Rear Access:** It is important that your mounting leaves plenty of access to the rear of the APDA-371 unit for wiring connections and maintenance. At least five inches (approx. 15 cm) is required. Full access to the back is recommended whenever possible. There must be a suitable access to the mains power switch on the rear side.
- **Top Access:** It is necessary to have a minimum of eight inches (approx.. 20 cm) clearance between the top of the APDA inlet receiver and the bottom of the shelter ceiling to accommodate the smart inlet heater which mounts on the inlet tube directly above the APDA.
- **Mobile Shelters:** If the APDA-371 is being installed into an equipment rack in a mobile shelter or van, the instrument **must** be supported from the bottom in addition to the rack brackets, due to additional strain. The foam shipping rings must also be inserted any time a mobile shelter is moved with the APDA-371 inside.
- **Rack Modifications:** It is often necessary to modify the top of the equipment rack by cutting a hole to allow the inlet tube to extend through to the ceiling. The drawing below shows the location of the hole.

**NOTE:** *The inlet heater is a cylinder which installs on the inlet tube two inches above the top of the inlet receiver of the APDA-371. If the APDA unit is to be mounted high in the rack, it may be necessary to make the hole in the top of the rack larger in order to clear the heater diameter. The heater is supplied with an insulation tube cover which may be modified as needed. Make sure these parts are going to fit before installing the APDA-371.*

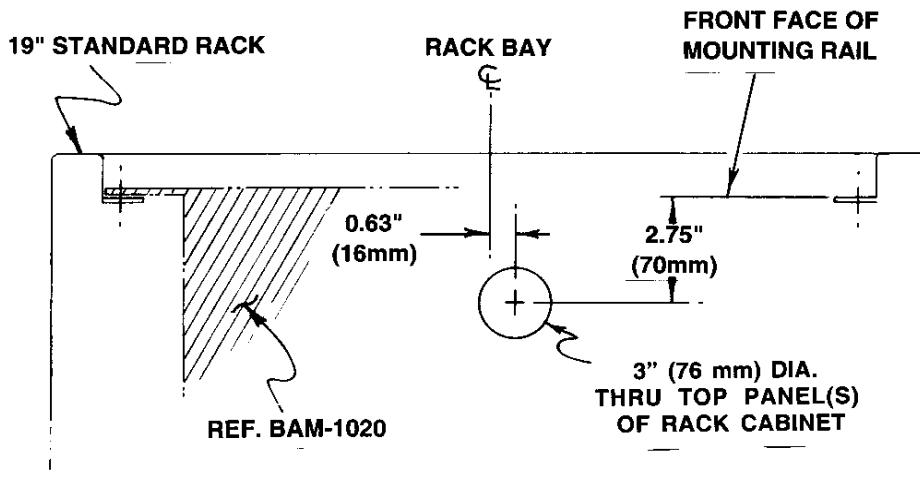

**(TOP VIEW OF RACK)**

Rack top modifications for inlet tube clearance



## 2.5 Installation Instructions in a Walk-In Shelter

Installation of the APDA-371 should be performed by personnel familiar with environmental monitoring equipment. There are no special precautions or handling concerns except for the normal level of care required for handling scientific equipment. Refer to the diagrams on the following pages.

### 1. Roof Modifications:

Determine the exact location where the APDA inlet tube will pass through the roof of the enclosure, and drill a 2 ¼" or 2 ½" diameter hole through the roof at that location. Make sure the hole is directly above where the APDA inlet receiver is to be located, as the inlet tube must be perfectly vertical. A plumb-bob is useful for determining where to locate the hole.

**NOTE:** *The inlet receiver on the APDA is slightly to the left (0.6 in, 15 mm) of the center line of the unit. See diagrams.*

### 2. Waterproof Flange:

Apply all-weather caulking around the top of the hole, and install the BX-801 roof flange onto the hole. It is usually best if the threaded barrel of the flange assembly is installed downward, into the hole. Secure the flange in place with four lag bolts or self-tapping screws (not supplied). Caulk around the screws to prevent leaks. Apply Teflon tape to the threads of the gray plastic watertight fitting, and screw it into the roof flange.

**NOTE:** Some users prefer to fabricate their own roof flange instead of using the one supplied by HORIBA, due to factors such as high snow loading or a sloped roof. Equipment damage from a leaking roof is not covered under warranty.

### 3. Inlet Tube – Installation and alignment:

Remove the white cap and rubber seal from the flange assembly. This makes it easier to install the inlet tube, as the rubber seal is a tight fit around the tube. Lower the inlet tube through the flange assembly in the roof and into the inlet receiver on the APDA. Make sure the inlet tube is fully seated.

It is very important for the inlet tube to be perpendicular to the top of the APDA. The nozzle may not close properly if there is binding caused by misalignment. A simple check is to rotate the inlet tube back and forth by hand (before tightening the roof flange seal or the APDA inlet set screws). If the inlet tube is installed straight, then the tube should rotate fairly easily while inserted into the APDA. If it does not rotate, check the inlet tube for vertical alignment or move the APDA slightly.

**It is always recommended that the exposed portion of the inlet tube inside the shelter be insulated.**

#### 4. Smart Inlet Heater Installation:

Before tightening the inlet tube in place, the BX-827 or BX-830 smart inlet heater (used on most APDA-371 units) must be installed on the tube. Pull the inlet tube up out of the inlet receiver, and pass the tube through the hole in the heater body (the cable end is the bottom). Then re-insert the inlet tube into the APDA. Position the bottom of the heater unit **two inches** above the top of the inlet receiver on the APDA, and securely tighten the two set screws in the heater to fasten it to the tube.

Included with the smart heater is a 12" tube of insulation. The tube is split down its length for easy application. Wrap the insulation around the heater body and peel back the adhesive cover strip to secure in place. The insulation may be cut to fit if needed. The insulation sleeve provides more consistent heating, and also prevents items from coming into contact with the hot heater body.

#### 5. Smart Inlet Heater Electrical Connections

All generations of the BX-827/830 Smart Heater have the same green metal power connector. However, there are two different configurations for the way the heater plugs into the APDA-371 depending on the heater control relay location. Make sure that you recognize which of the two following configurations you have.

Most units built between 2008 and 2012 were supplied with an external gray relay module which plugs into a mating **black plastic connector on the back of the APDA-371**. The Smart Heater connector plugs into the green connector on the top of this relay module, as shown in the left photo below. These external relay modules have their own AC power cord to supply power to the heater, and have a 3A fuse inside.

In the other possible configuration of the kit, the green metal Smart Heater connector simply plugs directly into the mating **green metal connector on the back of the APDA-371**. The heater relay is located inside the APDA-371, and the heater power comes from the APDA-371 AC power supply at line voltage and frequency, and is fused by the main 3.1A fuses in the power input module.

 **CAUTION!** It is possible to incorrectly force the green metal heater connector into the black plastic connector on an APDA-371 which is configured to use the external relay, even though both connectors have male pins. If this is done the APDA-371 will not be damaged, but the heater will not function and no sample RH control will occur!

 **CAUTION!** The heater relay controls live AC line voltage to the green socket in either version. Treat the green socket like a live power outlet whenever power is applied. Do not open or service the relay module or heater module when power is applied.

 **CAUTION!** The Smart Heater has triple redundant safety features to prevent overheating, but the heater surface temperature can exceed 70 degrees C during high humidity conditions. Use the white insulation sleeve to prevent contact with the heater during operation.



Two Different Smart Heater Power Configurations

## 6. Inlet Tightening:

After the inlet tube is aligned and the heater installed, slide the black rubber seal and white cap down over the top of the inlet tube and into the roof flange. It is easier if you wet the rubber seal with water first. Tighten the white plastic cap. Tighten the two set screws in the top of the APDA-371 inlet receiver.

## 7. Inlet Support Struts:

The BX-801 inlet kit usually comes with two angled aluminum struts to support the inlet tube above the roof and prevent the inlet from moving in the wind. These struts are typically fastened (about 90 degrees apart) to the inlet tube with a supplied hose clamp. The bottom ends of the struts should be fastened to the roof with lag bolts (not supplied).

**NOTE:** *Some installations may require different methods or hardware for supporting the inlet tube. Support the tube in the best manner available.*

## 8. Temperature Sensor:

Most APDA-371 units are supplied with a BX-592 (temperature) or BX-596 (temperature and pressure) sensor, which is attached to the inlet tube above the roof. The sensor cable must feed into the shelter to be attached to the APDA. In some cases it is easiest to simply drill a 3/8" hole through the roof about six inches away from the inlet tube, then feed the cable through the hole and caulk around it to prevent leaks. In some applications there may be a better place to feed the cable into the shelter. Route the cable into the shelter in the best manner. The BX-596 attaches directly to the inlet tube with a supplied U-bolt. If using a BX-592, fasten the aluminum cross-arm to the inlet tube, and clip the temperature probe to the cross-arm.

Connect the cable to the terminals on the back of the APDA-371 as follows. Additional optional HORIBA auto ID sensors may be connected to channels 1 through 5 to log other meteorological parameters. Details on these optional sensor connections are given in Section 10.2 of this manual.

| BX-596 AT/BP Sensor |                    |
|---------------------|--------------------|
| Wire Color          | Terminal Name      |
| Yellow (AT)         | Channel 6<br>SIG   |
| Black/Shield        | Channel 6<br>COM   |
| Red                 | Channel 6<br>POWER |
| Green               | Channel 6<br>ID    |
| White (BP)          | Channel 7<br>SIG   |

| BX-592 AT Sensor        |                    |
|-------------------------|--------------------|
| Wire Color              | Terminal Name      |
| Yellow or<br>White (AT) | Channel 6<br>SIG   |
| Black/Shield            | Channel 6<br>COM   |
| Red                     | Channel 6<br>POWER |
| Green                   | Channel 6<br>ID    |

### 9. Inlet Separator Heads:

For PM10 monitoring, the BX-802 Size-Selective Inlet is installed directly onto the inlet tube with no cyclone. To configure the APDA-371 for PM2.5 monitoring, install the PM2.5 size fractionator (EN-Approval: Sharp Cut Cyclone SCC BX-807) and the PM10 head as shown below. Use O-ring lubricant as needed.

### 10. Inlet Tube Grounding:

The two 1/4"-20 set screws located in the inlet receiver of the APDA should create a ground connection for the inlet tube to prevent static electricity from building up on the inlet tube under certain atmospheric conditions. This is also important in areas near electromagnetic fields, high voltage power lines, or RF antennas. Check the connection by scraping away a small spot of the clear anodizing near the bottom of the inlet tube, and use a multimeter to measure the resistance between this spot and the "CHASSIS" ground connection on the back of the APDA-371. It should measure only a couple of Ohms or less if a good connection is made with the set screws. If not, remove the set screws and run a 1/4-20 tap through the holes. Then reinstall the screws and check the electrical resistance again.

**NOTE:** *Anodized aluminum surfaces are non-conductive.*

### 11. Pump Location and Installation:

The best location for the vacuum pump is often on the floor under the rack or bench, but it may be located up to 25 feet away if desired. It may be preferable to locate the pump so that noise is minimized if the APDA-371 is in an area where personnel are present. If the pump is to be enclosed, ensure that it will not overheat. The Gast pumps have a thermal shutdown inside which may trip if overheating occurs. Route the clear 10 mm air tubing from the pump to the back of the APDA-371, and insert it firmly into the compression fittings on both ends. The tubing should be cut to the proper length and the excess tubing saved.

The pump is supplied with a 2-conductor signal cable which the APDA-371 uses to turn the pump on and off. Connect this cable to the terminals on the back of the APDA-371 marked "PUMP CONTROL" The end of the cable with the black ferrite filter goes toward the APDA. The cable has no polarity, so either the red or black wire can go to either terminal. Connect the other end of the cable to the two terminals on the pump.

There are two pump types available for the APDA-371. The Gast rotary vane pumps are louder and draw considerably more power than the Medo linear piston pumps, but have better vacuum capacity, especially at higher altitude or in 50 Hz applications. The Medo pumps are smaller, quieter, and more efficient, but aren't recommended for 50 Hz use.

## **12. Optional External Data Logger Connections:**

The APDA-371 has an analog output which may be recorded by a separate data logger if required. Connect the terminals on the back of the APDA marked "VOLT OUT +, -" to the data logger with 2-conductor shielded cable (not supplied). Polarity must be observed. The logger input must be correctly scaled in order to log the voltage accurately! Information on configuring this analog output is provided in Section 8 of this manual. A current loop output is also available.

Newer data loggers often interface to the APDA-371 using the digital serial ports for better accuracy. Information about this is also found in Section 8.

The APDA-371 has a variety of other telemetry I/O relays, error relays, and serial data connections located on the back of the APDA-371 as shown below. These items are described in Section 8 and Section 9 of this manual.

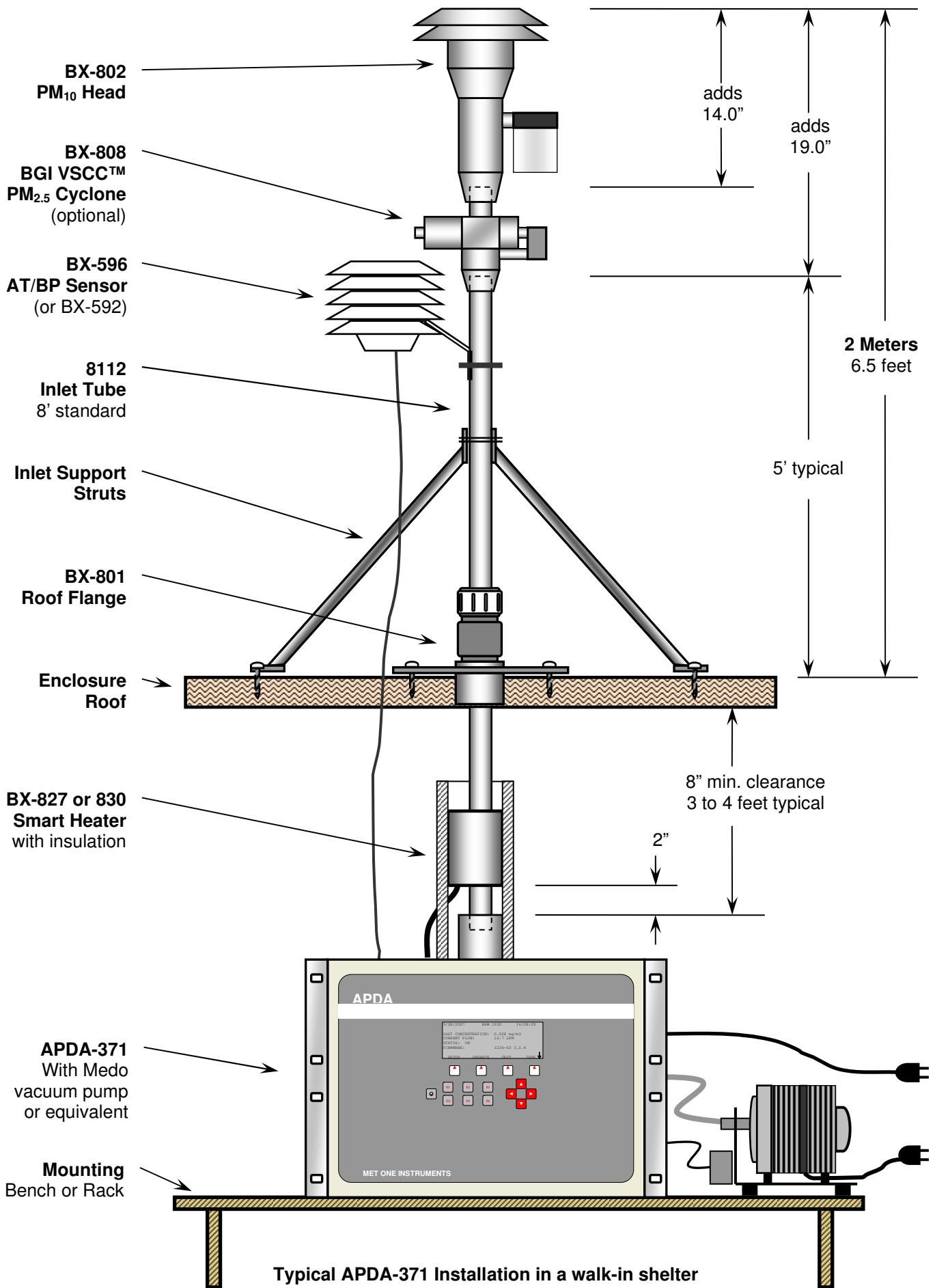

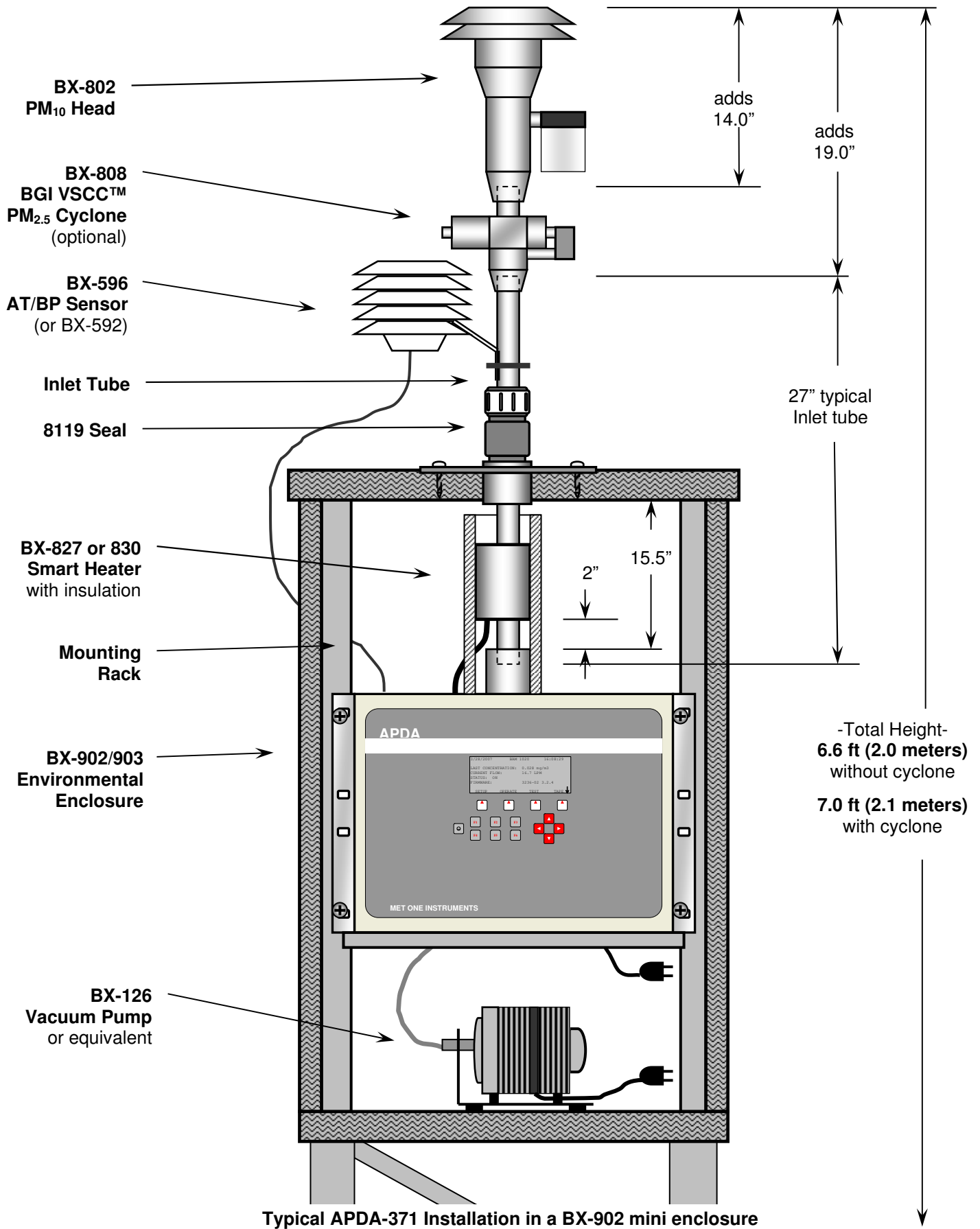

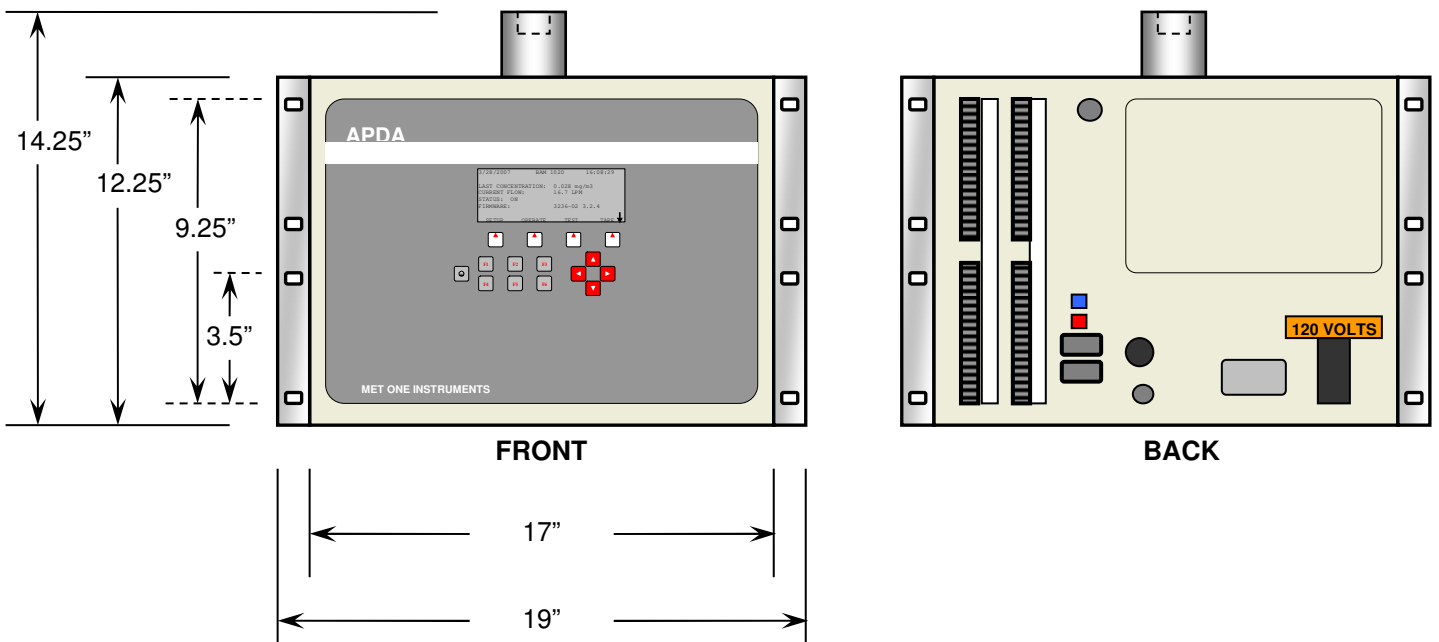
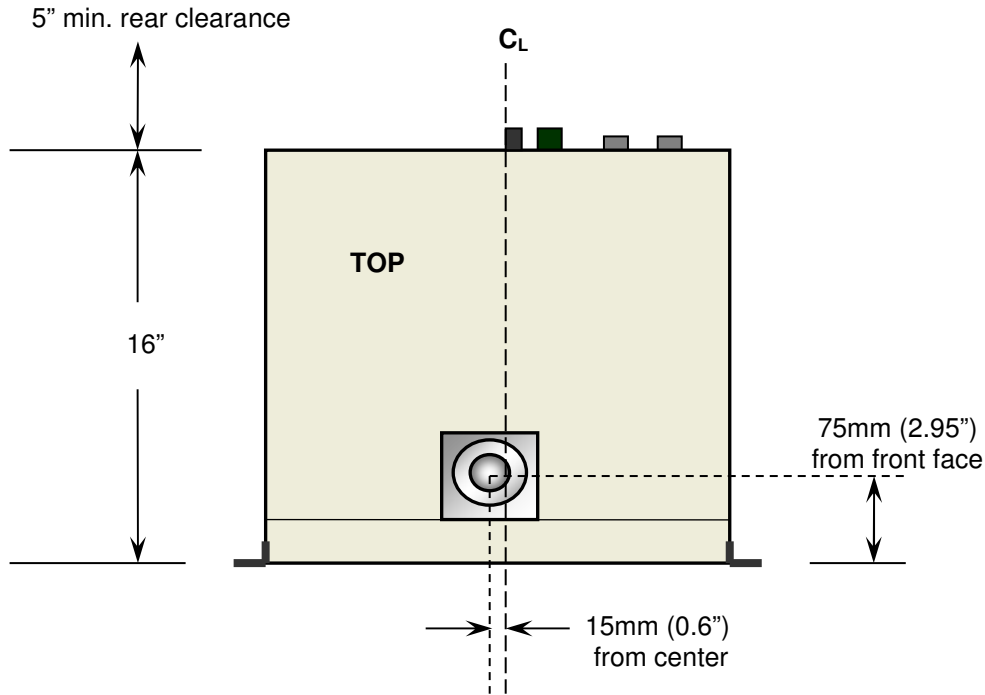

**APDA-371 mounting dimensions**



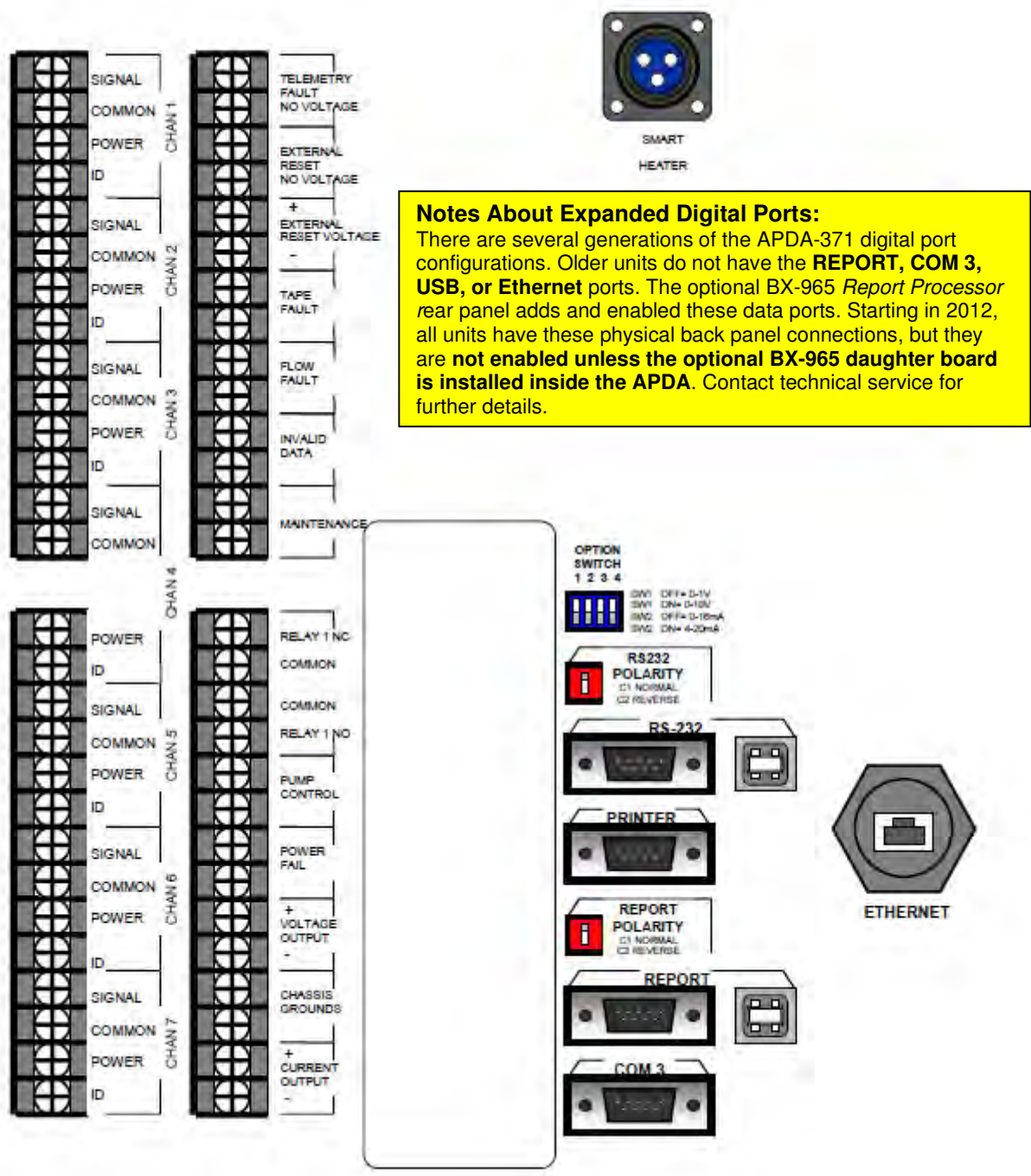

APDA-371 rear panel connections

## 2.6 Electrical Connections

The APDA-371 uses internal 120V AC motors for the tape control system. The power supply is factory-wired to run on **either 110-120V or 220-240V, and either 50Hz or 60Hz**. The external vacuum pump and inlet heater are also AC powered and voltage-specific, and should match the voltage setting of the APDA-371.

**NOTE:** *The pump power cord is hardwired, and may need to be replaced or adapted to match local outlet types outside of North America.*



**CAUTION!** *Your shelter and/or electrical service must be wired for the correct voltage and frequency in accordance with local electrical codes. Running the APDA-371, vacuum pump, or inlet heater on incorrect line voltage or frequency will cause improper operation.*

The current draw of the system varies considerably depending on optional accessories and environmental conditions. A dedicated 15 Amp electrical circuit is generally adequate to run a single complete APDA-371 system, unless a large air conditioner is on the same circuit. Consult a qualified electrician if unsure. A summary of some worst-case loads is given below:

| Model             | Description   | Amps         | Wattage      |
|-------------------|---|--------------|--------------|
| <b>APDA-371</b>   | APDA-371 only, 120V, worst case with tape transport motors running.     | <b>0.17A</b> | <b>20W</b>   |
| <b>BX-126</b>     | Medo Linear Piston Pump, 120V, 60Hz, at 16.70 L/min through clean tape. | <b>1.25A</b> | <b>150W</b>  |
| <b>BX-121</b>     | Gast Rotary Vane Pump, 120V, 60Hz, at 16.70 L/min through clean tape.   | <b>4.44A</b> | <b>530W</b>  |
| <b>BX-122</b>     | Gast Rotary Vane Pump, 230V, 50Hz, at 16.70 L/min through clean tape.   | <b>2.30A</b> | <b>530W</b>  |
| <b>BX-827</b>     | Smart Inlet Heater, 120V, 60Hz, running at 100% high RH duty cycle.     | <b>0.85A</b> | <b>100W</b>  |
| <b>BX-830</b>     | Smart Inlet Heater, 230V, 50Hz, running at 100% high RH duty cycle.     | <b>0.76A</b> | <b>175W</b>  |
| <b>BX-902B</b>    | Shelter One Mini Shelter, 120V, worst case with shelter heater ON       | <b>4.2A</b>  | <b>500W</b>  |
| <b>BX-903</b>     | Ekto Mini Shelter, 120V, 2000 BTU air conditioner.                      | <b>7.4A</b>  | <b>586W</b>  |
| <b>BX-904/906</b> | Ekto Mini Shelter, 120V, 4000 BTU air conditioner.                      | <b>13.5A</b> | <b>1172W</b> |

### Notes:

- The APDA transport motors only run for a few seconds each per hour. Quiescent APDA current is 0.1A.
- The vacuum pump runs for either 42 or 50 minutes per hour. Startup inrush current is higher.
- Smart Heater wattage drops to idle at 20% (120V) or 6% (230V) when filter RH is below 35%.
- The BX-902B shelter heater is usually off whenever shelter temp is over 40 degrees F, and can be disabled.
- Values are based on measurements or best available information. Additional information is available from Service.

**Fuses:** There are two 5x20mm, 3.15A, 250V fuses located inside the APDA-371 power switch module on the back of the APDA-371. They can be accessed by prying open the top of the small cover surrounding the switch. The power cord must be removed in order to open this cover.

**Power Outages and Battery Backup:** Any momentary AC power outages will reset the APDA-371 CPU and prevent data collection for the sample hour. The APDA-371 may be plugged into a PC-style uninterruptible power supply (UPS) battery back-up unit to prevent this. A UPS of at least 300 Watts is usually sufficient. The vacuum pump does not need to be connected to the UPS, because the APDA-371 can compensate for short pump flow outages of less than 1 minute duration. If the pump is to be backed up, then a much larger UPS wattage is required.

**Chassis Ground:** Connect one of the terminals marked "CHASSIS" on the back of the APDA-371 to an earth ground point using the green/yellow ground wire supplied with the APDA-371. A copper earth-ground rod is recommended. The chassis ground is primarily for added RFI/EMI noise immunity. The power cord also uses the standard electrical safety ground.

## 3 INITIAL SETUP OF YOUR APDA-371



This section describes the process for setting up and configuring your APDA-371, as well as the basic steps required to put the unit into operation.

Some of the topics in this section will direct you to other sections of this manual for more detailed information. It is assumed that the unit is already installed and sited as described in Section 2. In some cases it is useful to first set up the APDA-371 unit on a test bench before deployment or installation in order to explore the functions of the unit and perform setups. The following steps for starting up your unit are described in this section:

1. **Power on and warm up the unit.**
2. **Become familiar with the user interface**
3. **Load a roll of filter tape.**
4. **Perform a Self-Test.**
5. **Set the real-time clock, and review your SETUP parameters.**
6. **Perform a leak check and a flow check.**
7. **Return to the top-level menu and wait for automatic start at the top of the hour.**
8. **View the OPERATE menus during the cycle.**

### 3.1 Power Up

The APDA-371 has a power switch located on the back of the unit directly above the power cord. Verify that the unit is plugged in to the correct AC voltage, and that any electrical accessories are correctly wired before turn the unit on. (Section 2.6) When power is switched on the main menu screen should appear after a few seconds as shown below. The unit will probably flash an error indicating that there is no filter tape installed.

**NOTE:** Units running revision 3.1 or earlier firmware will display a slightly different main menu screen.

```
3/28/2007      BAM 1020      16:08:29
LAST CONCENTRATION:  0.028 mg/m3
CURRENT FLOW:       16.7 LPM
STATUS:  FILTER TAPE ERROR!
FIRMWARE:          3236-02 3.2.4
SETUP      OPERATE      TEST      TAPE
```

**Main menu screen**

### 3.2 Warm-up

The APDA-371 must warm up for **at least one hour** before an operation cycle is started. This is because the beta detector contains a vacuum tube which must stabilize every time the unit is powered up. This also allows the electronics to stabilize for optimal operation. This applies any time the unit is powered up after being off for more than a moment. Instrument setups and filter tape installation can be performed during this warm up time. Most agencies choose to discard the first few hours of concentration data after the APDA is powered up.

### 3.3 Using the Keypad and Display

When the APDA-371 is powered up it will display the main (top level) menu on the LCD display. This menu is the starting point for all functions of the APDA-371 user interface.

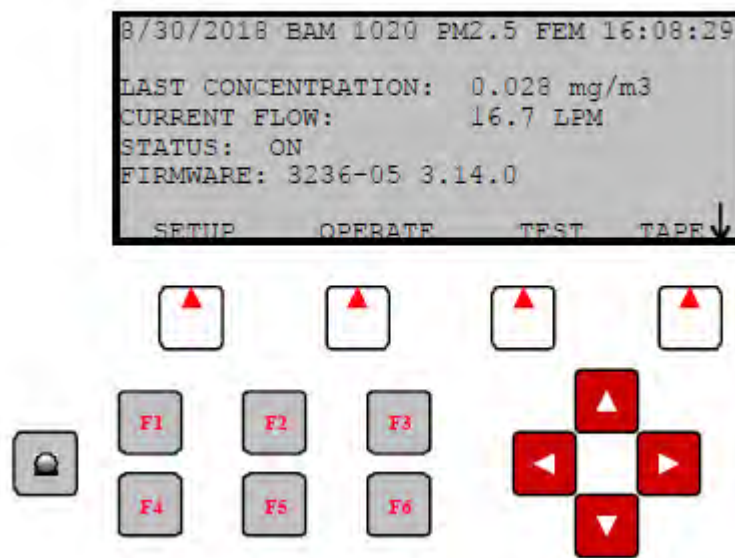

**The APDA-371 User Interface and Keypad**

#### Soft Keys:

Directly beneath the display are four white buttons called “soft-keys” or “hot-keys”. These are dynamic keys whose function changes in response to a menu option displayed directly above each key on the bottom row of the display. Whatever menu option is displayed above one of these keys is the function which that key will perform in that particular menu. These are used throughout the entire menu system for a wide variety of functions. For example, modifications made within a menu are usually not saved unless a SAVE soft-key is pressed. EXIT is also another common soft-key function.

**Arrow (Cursor) Keys:**

The four red arrow keys are used to scroll up, down, left, and right to navigate in the menu system, and to select items or change fields on the screen. The arrow keys are also often used to change parameters or increment/decrement values in the menu system.

**Contrast Key:**

The key with a circular symbol on it is for adjusting the light/dark contrast on the LCD display. Press and hold the key until the desired contrast is achieved. It is possible to over-adjust the contrast and make the entire display completely blank or completely dark, so be careful to set it to a visible level or it may appear that the unit is not operating.

**Function Keys F1 to F6:**

The function keys serve as shortcuts to commonly used menu screens, and can be safely pressed at almost any time without interrupting the sample cycle. The **F** keys are only functional from the main menu screen or for entering passwords. The factory default password is F1, F2, F3, F4.

- F1     **Current:**** This key is a shortcut to the OPERATE > INST screen, used to display the instantaneous data values that are being measured by the APDA-371. See section 3.12. The F1 key can be used without interrupting a sample cycle.
- F2     **Average:**** This key is a shortcut to the OPERATE > AVERAGE screen, used to display the latest average of the data recorded by the APDA-371. See Section 3.13. The F2 key can be used without interrupting a sample cycle.
- F3     **Error Recall:**** This key allows the user to view the errors logged by the APDA-371. The errors are sorted by date. The last 12 days which contain error records are available, and up to the last 100 errors can be viewed. The F3 key can be used without interrupting a sample cycle.
- F4     **Data Recall:**** This key allows the user to view the data stored in the APDA-371, including concentrations, flow, and all six external channels. The data is sorted by date, and the user can scroll through the data hour-by-hour using the soft-keys. Only the last 12 days which contain data records are available in this menu. The F4 key can be used without interrupting a sample cycle.
- F5     **Transfer Module:**** This key is used to copy the memory contents to an optional transfer storage module to retrieve the digital data without a computer. The transfer module option is obsolete and no longer used.. HORIBA recommends downloading the data with a laptop, computer or modem connection.
- F6     **(Blank):**** This key is not assigned a data function.

### 3.4 Filter Tape Loading

A roll of filter tape must be loaded into the APDA-371 for sampling. One roll of tape should last more than 60 days under normal operation. It is important to have several spare rolls of tape available to avoid data interruptions. HORIBA recommends wearing lint-free cotton gloves when handling the tape. Some agencies save the used rolls of tape for post-sampling analysis, although there is no guarantee that the sampled spots have not been contaminated. Used filter tape should never be “flipped over” or re-used! This will result in measurement problems. Loading a roll of filter tape is a simple matter using the following steps:

1. Turn on the APDA-371 and go to menu TAPE (NOTE: Not to the menu TEST > TAPE!). If the nozzle is closed (not in UP-Position), press the soft key TENSION.
  2. Lift the rubber pinch roller assembly and latch it in the UP position.
  3. Unscrew and remove the two clear plastic reel covers.
  4. An empty core tube **MUST** be installed on the left (take-up) reel hub. This provides a surface for the used tape to spool upon. HORIBA supplies a plastic core tube to use with the first roll of tape. After that, you can use the empty core tube left over from the previous roll. Never fasten the filter tape to the aluminum hub.
  5. Load the new roll of filter tape onto the right (supply) reel, and route the tape through the transport assembly as shown in the drawing. Attach the loose end of the filter tape to the empty core tube with adhesive cellophane tape or equivalent.
  6. Rotate the tape roll by hand to remove excess slack, then install the clear plastic reel covers. The covers must be tight in order to properly clamp the tape in place and prevent slipping.
  7. Align the filter tape so that it is centered on all of the rollers. Newer units have score marks on the rollers to aide in visually centering the tape.
  8. Unlatch and lower the pinch roller assembly onto the tape.
-  *The APDA-371 cannot automatically lower the rollers, and the APDA-371 will not operate if the pinch rollers are left latched in the up position!*
9. Press the TENSION soft-key in the TAPE menu. The APDA-371 will set the tape to the correct tension and alert you if there was an error with the process. Exit the menu.

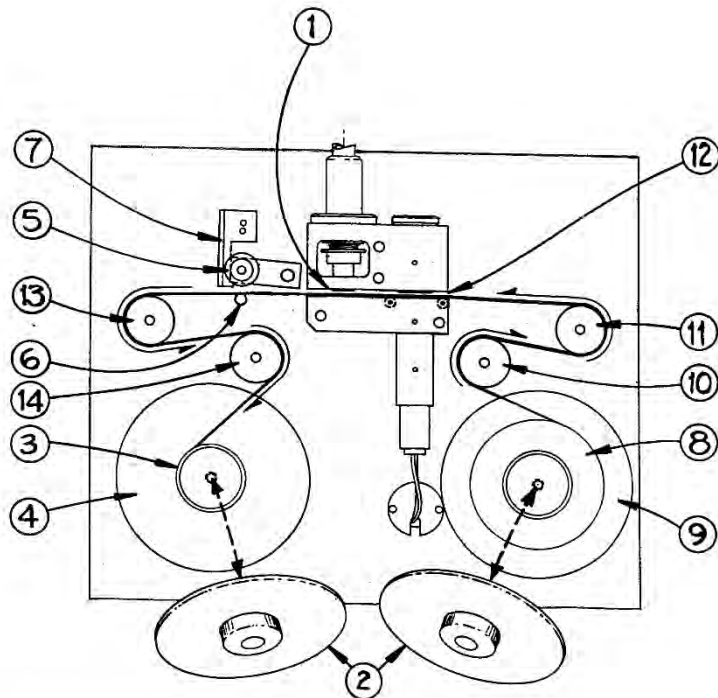
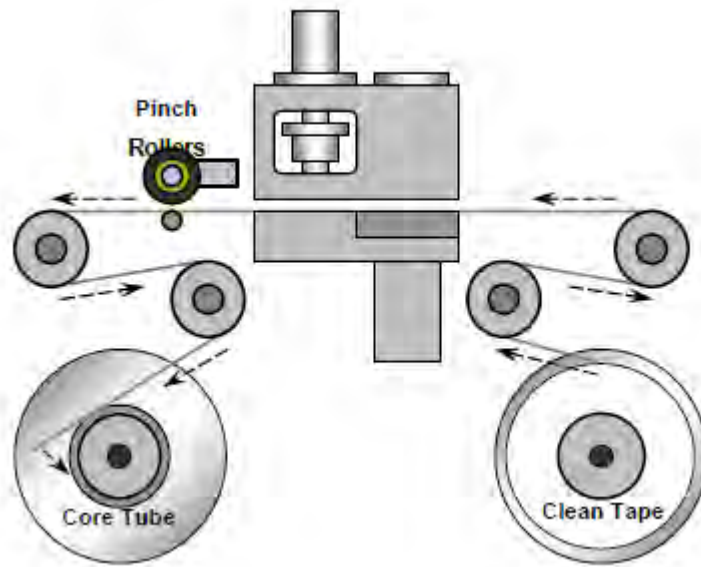

- |                                 |                              |
|---------------------------------|------------------------------|
| 1---NOZZLE IN "UP" POSITION     | 8---FILTER TAPE              |
| 2---CLEAR SPOOL COVER WITH KNOB | 9---SUPPLY SPOOL             |
| 3---EMPTY CORE TUBE             | 10---SUPPLY TENSION ROLLER   |
| 4---TAKE-UP SPOOL               | 11---RIGHT END ROLLER        |
| 5---PINCH ROLLERS               | 12---SAMPLING/MEASURING AREA |
| 6---CAPSTAN SHAFT               | 13---LEFT END ROLLER         |
| 7---LATCH                       | 14---TAKE-UP TENSION ROLLER  |

**Filter Tape Loading Diagram**



### 3.5 Self-Test

The APDA-371 has a built-in self-test function which automatically tests most of the tape control and flow systems of the unit. The self-test should be run right after each time the filter tape is changed, and it can also be used if the operator suspects a problem with the unit. More detailed diagnostic menus are also available in the APDA, and those are described in the troubleshooting section.

The self-test feature is located in the TAPE menu. Press the SELF TEST soft-key to start the test. The tests will take a couple of minutes, and the APDA-371 will display the results of each tested item with an **OK** or a **FAIL** tag. If all of the test items are OK, the status will show SELF TEST PASSED as shown in the drawing below. If any item fails, the status will show ERROR OCCURRED.

```
02/08/1999      15:29:30
LATCH: OFF      TAPE BREAK: OK
CAPSTAN: OK     TAPE TENSION: OK
NOZZLE DN: OK   SHUTTLE: OK
NOZZLE UP: OK   REF EXTEND: OK
FLOW: OK        REF WITHDRAW: OK
Status: SELF TEST PASSED
TENSION SELF TEST EXIT
```

**Self-Test Status Screen**

**LATCH:**

This will show OFF if the photo interrupter senses that the pinch rollers are unlatched as in normal operation. It will show ON if the roller assembly is latched in the up position. The tape cannot move if the rollers are up!

**CAPSTAN:**

The unit will rotate the capstan shaft forward and backwards and will check if the photo interrupter sees the shaft rotating. The Capstan shaft is what moves the filter tape back and forth.

**NOZZLE DN:**

The unit will attempt to lower the nozzle, and will check if the nozzle motor has moved to the down position with a photo interrupter. It is possible for the nozzle to become stuck in the UP position, even if the nozzle motor has successfully moved to the DOWN position. For this reason, proper inlet alignment and nozzle o-ring maintenance is necessary.

**NOZZLE UP:**

The unit will attempt to raise the nozzle, and will check if the nozzle motor has moved to the up position with a photo interrupter.

**FLOW:**

The unit will attempt to turn the pump on, and will then look for output on the flow sensor. This test takes about a minute and will fail if the pump is not connected.

**TAPE BREAK:**

The unit will move the supply and take-up motors to create slack in the filter tape, and look for proper operation of the tensioner photo interrupters.

**TAPE TENSION:**

The unit will tension the filter tape, and then check the condition of the tensioner photo interrupters.

**SHUTTLE:**

The unit will attempt to move the shuttle beam left and right, and will check the motion with a photo interrupter.

**REF EXTEND:**

The unit will attempt to extend the reference membrane, and will check the motion with a photo interrupter.

**REF WITHDRAW:**

The unit will attempt to withdraw the reference membrane, and will check the motion with a photo interrupter.

### **3.6 Initial SETUP Settings Considerations**

The APDA-371 comes pre-programmed with a wide array of default values for the settings which govern the measurement and calibration. Many of these values will not be changed, as the default values are accurate for the majority of applications. You will need to review the Setup Menus in Section 6 of this manual and decide if any values need to be changed. At the very least, review the following parameters:

1. Set the system clock in the SETUP > CLOCK menu. The APDA-371 clock may drift as much as a couple of minutes per month. It is important to check the clock at least once per month to ensure the samples are performed at the correct times.
2. Review the BAM SAMPLE, COUNT TIME, MET SAMPLE, RANGE, and OFFSET values in the SETUP > SAMPLE menu.
3. Review the FLOW RATE, FLOW TYPE, CONC TYPE, and HEATER CONTROL settings in the SETUP > CALIBRATE menu.
4. Review the scaling of any external sensors in the SETUP > SENSORS menu.
5. Review the Smart Heater control settings in the SETUP > HEATER menu.

### **3.7 Initial Leak Check and Flow Check**

The APDA-371 comes with factory-set flow calibration parameters which will allow the APDA-371 to accurately control the 16.70 L/min sample flow system right out of the box. However, due to minor variations between different types of flow transfer standards, it is best to calibrate the APDA flow system with your own traceable flow audit standard. Perform leak checks and flow checks/calibrations as described in Section 5. Become comfortable with these processes, as they will be performed on a routine basis.

### **3.8 Starting a Measurement Cycle**

When the preceding steps of Section 3 have been completed, exit out to the main top level menu. The "Status" line should display "ON" (no errors). If so, the unit will start at the top (beginning) of the next hour, and will continuously operate until it is commanded to stop.

The unit will stop if the operator sets the Operation Mode to OFF or enters any of the SETUP or TEST menus. The APDA-371 will also stop itself if a non-correctable error is encountered, such as broken filter tape or failed air flow.

### 3.9 The Flow Statistics Screen

In the main APDA-371 menu screen a small arrow has been added to the bottom right corner. When the DOWN ARROW button is pressed the APDA will display the FLOW STATISTICS screen as shown below. This screen displays the flow, temperature and pressure statistics for the current measurement cycle. Pressing the ARROW DOWN key while in this screen will further scroll down to the remaining parameters below the viewable area of the display. This screen will not interrupt the sample cycle. This function is only available with revision 3.2 firmware or later.

```
03/28/2007  FLOW STATISTICS  16:26:30
SAMPLE START: 2007/03/28 16:08:30
      ELAPSED: 00:18:00
      FLOW RATE: 16.7 LPM
AVERAGE FLOW: 16.7 LPM
      FLOW CV: 0.2%
      VOLUME: 0.834m3
↓
EXIT

FLOW FLAG: OFF
      AT: 23.0
      MAX AT: 23.5
AVERAGE AT: 23.0
      MIN AT: 22.5
      BP: 760
      MAX BP: 765
AVERAGE BP: 760
      MIN BP: 755
```

**The FLOW STATISTICS Screen**

### 3.10 The OPERATE Menus

Press OPERATE soft-key at the main menu to enter operate menu as shown below. This will not interrupt the sample if already running.

```
11/15/2006   OPERATE MODE   14:13:07
              ↑ = ON
              ↓ = OFF
Operation Mode: ON
              Status: ON
NORMAL      INST      AVERAGE      EXIT
```

#### The OPERATE Menu

The DOWN arrow can be used to set the Operation Mode from ON to OFF. This will stop the measurement cycle, but will not power-down the APDA-371.

**NOTE:** Even if the operator sets the Operation Mode to OFF, or the unit stops itself due to an error, it will still automatically set the mode back to ON at the top of the hour, and try to run a new cycle!

The only ways to prevent the unit from automatically starting a cycle are to power off the unit, leave the unit in a TEST or SETUP menu, or leave the pinch rollers latched in the UP position.

The OPERATE menu has three soft-key options for viewing the operating status and sensor measurements while the unit is operating: NORMAL, INST, and AVERAGE.

### 3.11 The NORMAL Screen

Normal Mode is the primary operation screen which displays most of the important parameters of the sample progress in one place, as shown below. Many operators leave their APDA-371 in the NORMAL screen whenever the unit is operating, instead of the Main menu.

```
11/15/2006   Normal Mode   11:27:54
              Flow(STD) : 16.7 LPM
              Flow(ACTUAL) : 16.7 LPM
LAST C : 0.061 mg/m3      Press: 764 mmHg
LAST m : 0.806 mg/cm2    RH: 37 %
              Heater: OFF
              Delta-T: 4.2 C
STATUS: SAMPLING        EXIT
```

#### The NORMAL Menu

The **LAST C** value indicates the last concentration record, updated at the end of the cycle. The **LAST m** value indicates the last measured value of the reference span membrane. The value should be very close or equal to the expected value (**ABS**). The other values are instantaneous measurements.

### 3.12 The INSTANTANEOUS Screen

The INST (Instantaneous) screen displays the instantaneous data values that are being measured by the APDA-371. This screen is useful for monitoring the current reading of any optional sensors that may be connected to the APDA-371. All values except **Conc** (concentration) and **Qtot** (total flow volume) are current. The Conc represents the concentration of the last period. Qtot represents total flow volume during the last period.

|            |           |          |           |
|------------|-----------|----------|-----------|
| 11/15/2009 |           | 11:27:54 |           |
|            | Eng Units |          | Eng Units |
| 1 Conc     | 0.010 mg  | 2 Qtot   | .834 m3   |
| 3 WS       | 0.000     | 4 WD     | 0.000     |
| 5 BP       | 0.000     | 6 RH     | 0.000     |
| 7 SR       | 0.000     | 8 AT     | 0.000     |
|            |           | VOLT/ENG | EXIT      |

#### The Instantaneous Menu

The VOLT / ENG soft-key toggles the displayed values between units and voltages, useful for diagnostic checks on external sensors.

### 3.13 The AVERAGE Screen

The AVERAGE screen is similar to the INST screen, except that the concentration and flow are presented as the previous hour's average values, and the six external datalogger channels are average values over the average period of the data logger (set by the MET SAMPLE value in the SETUP > SAMPLE menu - usually also 60 minutes).

## 4 THE MEASUREMENT CYCLE



This section describes the measurement and timing cycle of the APDA-371 instrument. A clear understanding of the measurement is helpful for the effective operation and maintenance of the unit. For advanced information on the underlying theory and mathematics of the measurement see Theory of Operation, Section 11.

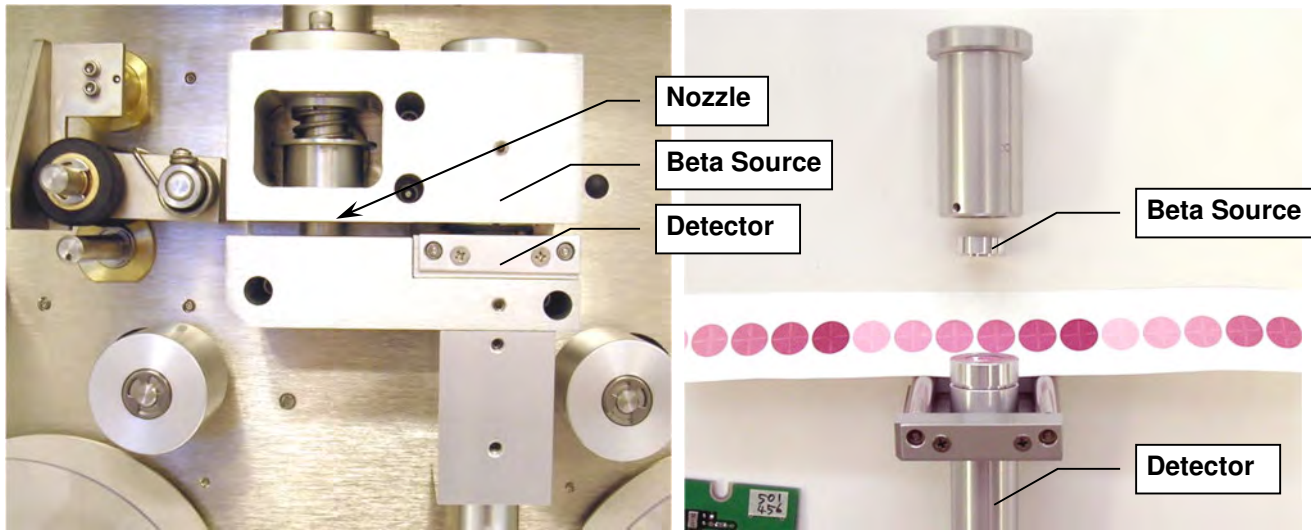

APDA-371 Sample and Measurement Stations

### 4.1 The One-Hour Cycle Timeline

The APDA-371 is almost always configured to operate on 1-hour cycles. The unit has a real-time clock which controls the cycle timing.

APDA-371 monitors operating with firmware 3236-5 version 3.7.1 or later may be configured for PM10 or PM2.5 operation.

When configured as a US-EPA and EU designated equivalent method for PM2.5, COUNT TIME must be set to 8 minutes. If you desire to operate the APDA-371 as a non-designated method for PM2.5 monitoring you may set the COUNT TIME to 4, 6, or 10 minutes.

When running the APDA-371 as a US-EPA designed equivalent method for PM10 COUNT TIME may be set to 4, 6, 8, or 10 minutes. When running the APDA-371 as a EU designed equivalent method for PM10 COUNT TIME must be set to 4 minutes.



*The COUNT TIME on the APDA-371 is user selectable, but is generally to be set to 4 minutes for PM10 measurement or to 8 minutes for PM2.5 measurement according to EN approval.*

The total measurement cycle is 1 hour. The pump sampling time may be calculated by subtracting twice the COUNT TIME from 60 minutes and then subtracting an additional 2 minutes to allow for tape movement. Therefore a COUNT TIME of 8 minutes would provide a pump sampling time of 42 minutes ( $60 - (8 + 8 + 2)$ ), a COUNT TIME of 4 minutes would provide a pump sampling time of 50 minutes ( $60 - (4 + 4 + 2)$ ).

**NOTE:** This cycle will be slightly altered if the APDA-371 is operated in the special Early Cycle mode with an external data logger. See Section 8.2.

The example below provides an example of the timing of a measurement cycle with a COUNT TIME of 8 minutes.

1. **Minute 00:** The beginning of an hour. The APDA-371 immediately advances the filter tape forward one "window" (the next fresh, unused spot on the tape). This takes a few seconds. The new spot is positioned between the beta source and the detector, and the APDA begins counting beta particles through this clean spot for exactly eight minutes. ( $I_0$ )
2. **~Minute 08:** The APDA-371 stops counting beta particles through the clean spot ( $I_0$ ), and moves the tape exactly four windows forward, positioning that same spot directly under the nozzle. This takes a few seconds. The unit then lowers the nozzle onto the filter tape and turns the vacuum pump on, pulling particulate-laden air through the filter tape (the spot in which  $I_0$  was just measured) for 42 minutes at 16.7 liters per minute.
3. **~Minute 50:** The APDA-371 turns the vacuum pump off, raises the nozzle, and moves the filter tape backwards exactly four windows. This takes a few seconds, and puts the spot that was just loaded with particulate back between the beta source and the detector. The APDA begins counting beta particles through this (now dirty) spot of tape for exactly eight minutes ( $I_3$ ).
4. **~Minute 58:** The APDA-371 stops counting beta particles through the dirty spot ( $I_3$ ). The unit uses the  $I_0$  and  $I_3$  counts to calculate the mass of the deposited particulate on the spot, and uses the total volume of air sampled to calculate the concentration of the particulate in milligrams or micrograms per cubic meter of air. The APDA then sits idle and waits a few moments for the remaining time in the hour to expire.
5. **Minute 60:** The beginning of the next hour. The APDA-371 instantly records the just-calculated concentration value to memory and sets the analog output voltage to represent the previous hour's concentration. The unit advances a new fresh spot of tape to the beta measurement area and the whole cycle starts over...

## 4.2 Automatic Span Check During The Cycle

While the vacuum pump is on and pulling air through the filter tape as described above the APDA-371 performs a span check. The user may set up the APDA-371 to perform the span check hourly, once per day, or not at all. The APDA-371 also performs a stability test:

1. **Minute 08:** When the APDA-371 has just finished moving the clean spot to the nozzle and turned the pump on) there is another clean spot of filter tape upstream four windows, between the beta source and the detector. This same spot will stay there for the entire time the pump is on, as the tape cannot move with the nozzle down. The APDA begins counting the beta particles through this spot for exactly eight minutes ( $I_1$ ).
2. **Minute 16:** The APDA-371 stops counting beta particles through this spot ( $I_1$ ), and extends the Reference Membrane between the beta source and the detector, directly above the spot of filter tape that was just measured. The Reference Membrane is an extremely thin film of clear Mylar held in a metal tongue. The membrane usually has a known mass density ( $\text{mg}/\text{cm}^2$ ). The APDA starts counting beta particles for eight minutes again, this time through the membrane *and* the filter tape spot at the same time ( $I_2$ ).
3. **Minute 24:** The APDA-371 stops counting beta particles through the membrane ( $I_2$ ), withdraws the membrane assembly, and calculates the mass of the membrane "m", as if it were particulate on the filter tape spot.
4. **Minute 42 :** (Eight minutes before the pump stops) The APDA-371 counts the beta particles through the same spot again (without membrane) for another eight minutes (called  $I_1'$  or  $I_1$  prime). This checks the ability of the unit to hold a constant output when measuring blank filter tape, and is not otherwise used.

The mass density "*m*" (mg/cm<sup>2</sup>) of the reference membrane calculated during this automatic process is compared to the known mass of the membrane; the "**ABS**" value. During factory calibration, the actual mass of each individual span foil is determined and saved as the **ABS** value of the APDA in which it is installed. Each hourly measurement of *m* must match the **ABS** value within ±5%. If not, the unit records a "D"-Alarm for that hour's data. Typically, the hourly value of *m* is within just a few mg/cm<sup>2</sup> of the expected value. This span check provides a method of internal diagnostics for the measurement system, and for the monitoring of external variables such as temperature variations or pressure changes. The **ABS** value is unique to each APDA-371, and can be found on the calibration sheet. Most membrane alarms are caused by a dirty membrane foil.

The stability measurements *I1* and *I1'* may be compared to determine if the beta counts have changed appreciably during the measurement cycle. Rapid changes in temperature, relative humidity or other factors may lead to this.

### **4.3 Sample Period Description**

The sample period is the time when the vacuum pump is pulling dust-laden air through the APDA-371. As the air enters the inlet, it first passes through the external PM<sub>10</sub> head which has a screen to keep out bugs and debris, and uses inertia to separate out and trap particle larger than 10 microns in size. For PM<sub>2.5</sub> measurement, the air then immediately passes through the Sharp Cut Cyclone SCC (BX-807) (mandatory for EN approval) or the optional PM<sub>2.5</sub> Very Sharp Cut Cyclone (BGI VSCC™) which further separates out and traps particles larger than 2.5 microns in size.

The air then goes down the inlet and through the filter tape, where the remaining particles are deposited. Some particles smaller than about 0.2 µm may pass through the filter tape and be exhausted. After the sample period is completed and the particulate spot is measured, there is almost always a clearly visible spot of dirt on the filter tape where the particulate was deposited. The APDA-371 will put the spots very close together on the tape.

### **4.4 Filter Tape Use**

The APDA-371 positions the filter spots very close to one another so as not to waste filter tape. Once each day at midnight, the APDA-371 will skip a spot (there will not be a spot where one is expected to be). This is done to make it easier for the user to match the spot on the take up spool with the hour and the day the spot was generated if this is necessary to be done.



## 5 FLOW SYSTEM and FLOW CALIBRATIONS



### 5.1 Flow System Diagram

The APDA-371 airflow control system is very simple and effective, consisting of a few rugged components. Proper operation of the flow system is critical if accurate concentration data is to be obtained from the unit. The key aspects of proper flow system maintenance are **Leak Checks, Flow Checks, and Nozzle Cleaning**. These processes are described in this section. HORIBA recommends performing a leak check and nozzle cleaning before flow calibrations, as a leak can affect the flow. Flow calibrations require a reference flow meter and a reference standard for ambient temperature and barometric pressure. Traceable standards (e.g. NIST, DAkkS) are required in many applications. HORIBA suggests the BGI DeltaCal® brand (available from HORIBA as the BX-307 option). It includes flow, temperature and pressure standards in one unit.

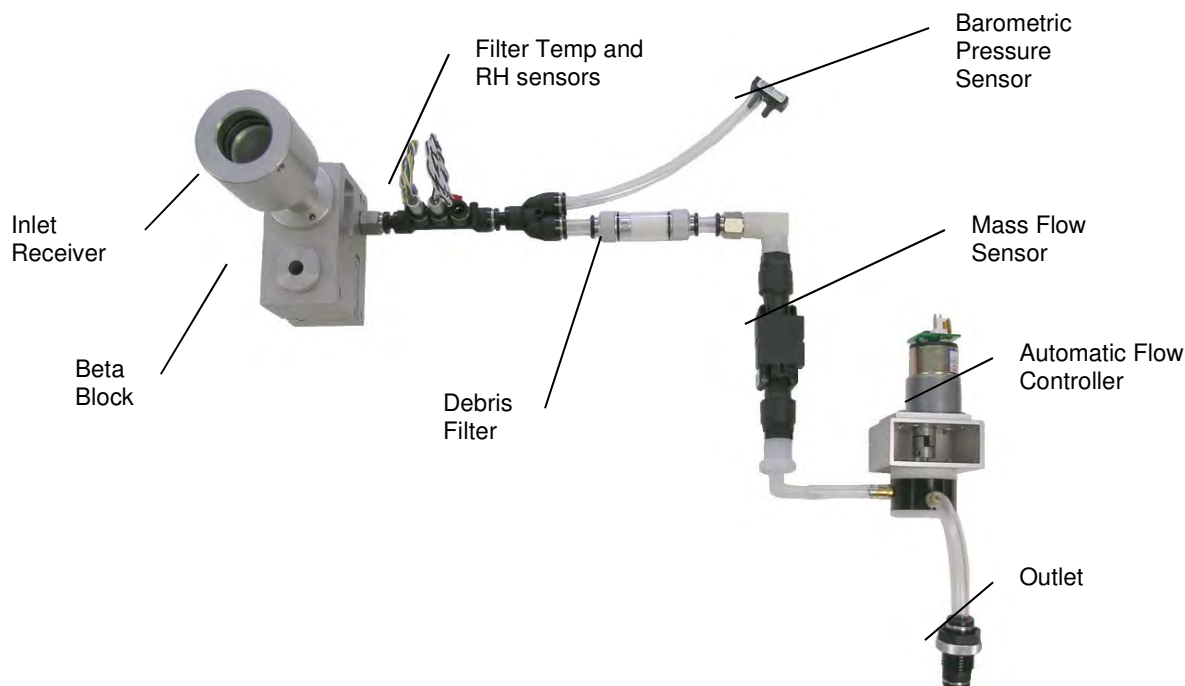

APDA-371 Flow System

## 5.2 Flow rate control

The APDA-371 is designed to operate with an airflow rate of 16.7 liters per minute (lpm). The flow rate must be maintained at this value in order for the commonly used the EPA PM10 inlet head (BX-802) and PM2.5 cyclones (BX-807 for EU designation, alternatively BX-806, BX-808 or BX-809) to work effectively. All of these separators use the inertia of the particles as they flow through the inlet to sort out the ones above a certain size (cut point) so that they won't be measured by the instrument. If the airflow rate is not maintained within  $\pm 5\%$  of the design value flow rate of 16.67 lpm, then particles of the wrong size may be allowed through or sorted out. Periodic APDA-371 airflow checks and calibrations must be performed to ensure the unit maintains the flow within the EPA and EN (EN 16450) specified ranges.

All APDA-371 monitors have a mass flow sensor and a barometric pressure sensor. The APDA-371 is also equipped with an ambient temperature sensor model BX-592 or BX-596. Temperature and barometric pressure measurements are needed to convert mass flow into volume flow rate (LPM).

## 5.3 Flow Control and Flow Reporting Types – Standard or Actual Flow

APDA-371 monitors with firmware revision 3.0 or later (after 2006) have both a FLOW TYPE and a CONC TYPE setting. Both can be set to either STD or ACTUAL (see Section 6.3). The APDA-371 is capable of controlling the flow using either standard or actual temperature/pressure conditions, and can independently report the particulate concentrations based on either a standard or actual volume of sampled air.

### ACTUAL Flow Control:

FLOW TYPE should always be set to ACTUAL for firmware version 3.0 or greater. Under actual flow control, ambient temperature and barometric pressure measurements are used to convert the measured mass flow into volumetric flow (LPM). As the measured temperature and barometric pressure change, the mass flow controller will adjust its output to maintain constant volumetric flow. CONC TYPE may be set to ACTUAL in which case sampled volume is reported in (actual) LPM sampled. CONC TYPE may also be set to STD, in which case sampled volumes are adjusted and reported under standard conditions (25°C, 1 atm.).

### STANDARD Flow Control:

This mode of operation is not recommended as the cut points for the PM10 inlets and the PM2.5 size fractionators require a nominal flow of 16.70 actual liters per minute. All APDA-371 monitors built since 2008 include a mass flow controller as standard equipment. External temperature sensors (either BX-592 or BX-596) are required for mass flow control.

### ACTUAL Flow Reporting:

To report mass concentrations under actual conditions set **CONC TYPE** to **ACTUAL**. This configuration is almost always used for PM2.5 concentration reporting. It is also used when reporting PM10 concentrations when paired APDA-371 monitors are used for PM10-2.5 monitoring.

### STD Flow Reporting:

To report mass concentrations under standard conditions set **CONC TYPE** to **STD**. The APDA-371 will then convert the actual volume sampled during the measurement cycle into the corresponding standard volume and report the mass concentration under standard conditions.

## 5.4 Total Flow ( $Q_{TOT}$ ) and Flow Rate (LPM) Conversions

The  $Q_{TOT}$  measurement can be converted to LPM by multiplying the  $Q_{TOT}$  value by 1000, then dividing by the APDA Sample Time. For example, to determine what the flow rate was of a 42 minute sample with a  $Q_{TOT}$  value 0.700, perform the following calculation:

$$(Q_{TOT} * 1000) / \text{Sample Time} = (0.700 * 1000)/42 = 16.67 \text{ LPM}$$

## 5.5 About Leak Checks, Nozzle Cleaning and Flow Checks

HORIBA recommends that users perform leak checks, nozzle and vane cleaning (if needed) and a flow check or calibration (if needed) at least once a month. Complete flow system maintenance typically requires less than 10 minutes to perform.

The best order for the monthly flow system checks is:

1. **As-found leak check.**
2. **Nozzle and vane cleaning.**
3. **As-left leak check.** (If a leak was corrected)
4. **Three-point flow check/audit and calibration if required.**

If an air leak is found, it could be caused by degraded O-rings, or an improper inlet tube to receiver connection. However, it *almost always* occurs at the interface between the nozzle and the filter tape due to debris buildup. There is normally an insignificant amount of leakage at the tape interface, but an excessive leak lets an unknown portion of the 16.70 L/min sample flow to enter the system at the leak point instead of the inlet. This could cause the total volume of air sampled through the inlet to be incorrect, and the resulting concentration data could be unpredictably biased.



*The APDA-371 cannot automatically detect a leak at the tape/nozzle interface because the airflow sensor is located downstream of the filter tape. Allowing a significant leak to persist may result in concentration data being invalidated!*

Routine leak checks and nozzle cleaning prevent any significant leaks from forming. Performing an as-found leak check before cleaning the nozzle or performing any service is needed for validating data collected since the last successful leak and flow check.

Even if the leak check value is found to be within acceptable bounds, the nozzle and vane should still be cleaned if any buildup or debris is noticed.

## 5.6 Leak Check Procedure

Perform the following steps to check for leaks for APDA-371:

1. Go to the TEST > TAPE menu. This interrupts the sample cycle of the APDA-371. Press the softkey FWD to advance the tape to a fresh, unused spot.
2. (Optionally) Before carrying out further servicing, some operators perform an “as found” flow check. In this case, please install the reference flow meter at the inlet and check the 16.7 lpm flow rate in the screen TEST>FLOW. Take a note of the “as found” flowrate but do not calibrate the flow parameters before finalizing leak checks and nozzle/vane cleaning procedures.
3. Remove the PM<sub>10</sub> head from the inlet tube. Install a BX-305 or BX-302 leak test valve (or equivalent valve for auditing FRM samplers) onto the inlet tube. In case of using the PM2.5-cyclone, please install the leak test valve onto the cyclone, as the cyclone is a potential source of leaks and hence should be included. Turn the valve to the ON position
4. In the TEST > PUMP menu, turn on the pump. Let the flow rate stabilize and push then the LEAK key to switch on the leak test mode.
5. Turn the leak valve on the inlet to the closed position to prevent air entering the inlet tube. Within approx.. 20 seconds, the pump flow rate should drop below 1.0 lpm. Take a note of the found results. If the leak rate is greater than 1.0 lpm, a leak could be possible in the flow system. If the leak rate is greater than 1.5 lpm, a significant leak is possible.
6. If there is a leak, it has to be fixed. First perform leak check again with a removed PM2.5 cyclone (if used). Clean the nozzle and the vane as described below and perform the test again. If the leak is fixed and the leak rate is below 1.0 lpm, take note of the “as left” leak rate.
7. Switch off the leak test mode and the pump.
8. Open the leak test valve slowly and take it away. Go ahead with nozzle and vane cleaning and flow checks-

### Interpretation of leak test results:

- a. A properly functioning APDA with a clean nozzle and vane will usually have a leak value significantly below 1.0 lpm, typically about **0.5 lpm** or less using this method, depending on the type of pump used. The exact “best case” value is varying with the used type of pump and the local altitude.
- b. The reason for the 1.0 lpm leak flow allowance is due to the test conditions. With the inlet shut off the vacuum in the system is very high, about 21 “ Hg. This is many times greater than the APDA-371 will encounter during normal sampling. If the leak reading during this test is less than 1.0 lpm, there should not be a significant leak during normal operation.
- c. In case of using an inlet tube with a length > 8 feet, the stabilization of the leak rate can take one or two minutes.

**Advanced leak checks:**

Leaks can be further isolated using a soft rubber sheet with a ¼” hole in it, such as HORIBA part 7440. The filter tape can be removed and the rubber seal inserted with the hole centered under the nozzle. The seal allows the leak check to be performed as usual, but without any leakage through the filter tape. The leak value should drop to 0.2 lpm or less with this method. A leak can be further isolated by using a part of the seal without a hole. This allows a leak test to be performed only on the system below the filter tape junction. If the nozzle and vane are thoroughly clean, but a leak persists, then see Section 7.7 for some troubleshooting steps for leaks in other parts of the flow system.

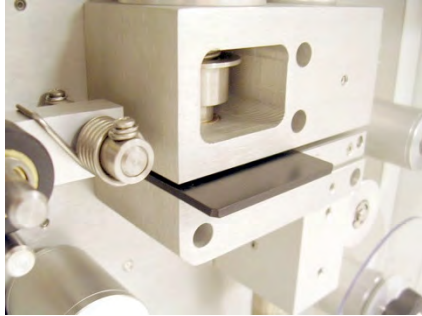

**7440 Leak isolation shim**

**5.7 Nozzle and Vane Cleaning Procedure**

The nozzle and tape support vane (located under the nozzle) must be inspected regularly and cleaned as needed in order to prevent leaks at the interface between these parts and the filter tape. We recommended that the nozzle and vane be inspected monthly for tape build up. Some sites may require a more frequent inspection and cleaning interval. APDA-371 monitors operated in hot, humid environments may require more frequent nozzle and vane cleaning. When the nozzle and vanes are not regularly cleaned filter tape debris may build up. This can lead to pin holes being punched through the filter tape which can in turn cause flow leaks and erroneous beta ray measurement. Use the following steps to clean the nozzle and vane parts:

1. Latch up the tape pinch rollers, and raise the nozzle in the TEST > PUMP menu. Slide the filter tape out of the slot in the beta block nozzle area. It is not necessary to completely remove the filter tape from the APDA-371.
2. With the nozzle up, use a small flashlight to inspect the vane. Any debris will usually be visible. Clean the vane surface with a cotton-tipped applicator and deionized water or isopropyl alcohol. Hardened deposits may have to be carefully scraped off with the wooden end of the applicator. Take care not to damage the vane!
3. Lower the nozzle in the TEST > PUMP menu. Lift the nozzle with your finger and insert another wet cotton applicator between the nozzle and the vane. Let the nozzle press down onto the swab with its spring pressure. Use your thumb to rotate the nozzle while keeping the swab in place. A few rotations should clean the nozzle lip.
4. Repeat the nozzle cleaning until the swabs come out clean, then inspect the nozzle lip and vane again, looking for any burrs which may cause tape damage.

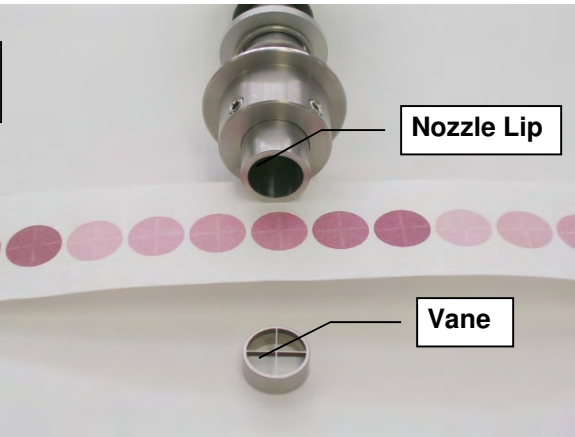
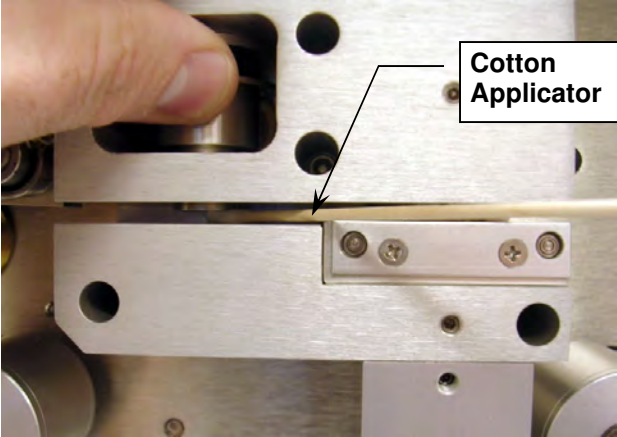

### Nozzle and Vane Cleaning, and Disassembled View

The figure below shows the difference between good and bad filter tape spots. The tape on the left is from a properly operated APDA-371 with a clean nozzle and vane. Notice the particulate spots have very crisp edges, are perfectly round, and are evenly distributed.

The tape on the right is from a unit which has not been properly maintained. A spot of debris has built up on the vane, and is punching a pin-hole at the edge of each spot. These holes can allow beta particles to get through un-attenuated which negatively affects accuracy even if the nozzle is not leaking. The spots also show a “halo” effect due to air leaking in around the edged because the debris has built up to the extent that the nozzle no longer seals correctly. These faults are easily corrected and prevented by keeping the nozzle and vane clean.



**APDA-371 hourly filter tape spots**

## 5.8 Field Calibration of Flow System – Actual (Volumetric) Flow Mode

Flow calibrations, checks, or audits on any APDA-371 set for actual flow control are very fast and easy. An ambient temperature sensor must be connected to input channel 6. The FLOW TYPE setting must be set to ACTUAL in the SETUP > CALIBRATE menu, or the flow calibration screen will not even appear as an option in the TEST menu. Perform a leak check and nozzle cleaning before doing any flow calibrations.

The TEST > FLOW calibration screen is shown below. The “BAM” column displays what the APDA-371 measures for each parameter. The “STD” column is where you can enter the correct values from your traceable reference standard device. The <CAL> symbol appears to the left of row of the active selected parameter. The selected parameter can be changed by pressing the NEXT key. No calibration changes are made to the selected parameter unless the CAL or DEFAULT key is pressed.



*The ambient temperature and pressure are always calibrated before the flow, because the APDA-371 uses these parameters to calculate the air flow rate in actual mode.*

| MULTIPOINT FLOW CALIBRATION |         |         |       |           |
|-----------------------------|---------|---------|-------|-----------|
|                             | TARGET  | BAM     | STD   |           |
|                             | AT:     | 23.8    | 23.8  | C         |
|                             | BP:     | 760     | 760   | mmHg      |
| <CAL>                       | FLOW 1: | 15.0    | 15.03 | 15.00 LPM |
|                             | FLOW 2: | 18.4    | 18.41 | 18.40 LPM |
|                             | FLOW 3: | 16.7    | 16.67 | 16.70 LPM |
| CAL                         | NEXT    | DEFAULT | EXIT  |           |

**Actual Flow Calibration Screen**

1. Enter the TEST > FLOW menu as shown above. The nozzle will lower automatically when this screen is entered.
2. (Optional Audit Only) To perform a simple flow “check” or “audit” in which no calibrations are to be changed, simply use the NEXT soft key to select the AT (temperature), BP (pressure), and FLOW 3 (16.7) parameters one at a time. Compare the BAM column reading to your standard device for each parameter, and record the results. No calibrations are altered if the CAL or DEFAULT keys are not pressed. If calibration is required, go on to step 3.
3. Select the AT parameter if not already selected. Measure the ambient temperature with your reference standard device positioned near the APDA-371 ambient temperature probe. Enter the value from your reference standard into the STD field using the arrow keys. Press the CAL soft key to calibrate the BAM reading. The BAM and STD temperature values should now be the same.
4. Press the NEXT key to select the BP field. Enter the barometric pressure value from your reference standard into the STD field, and press the CAL soft key to calibrate the BAM reading. The BAM and STD pressure values should now be the same.



5. After the temperature and pressure readings are both correct, remove the PM10 head from the inlet tube and install your reference flow meter onto the inlet tube. Press the NEXT key to select the first flow point of 15.0 L/min. The pump will turn on automatically.

*Allow the APDA-371 to regulate the flow until the BAM reading stabilizes at the target flow rate.*

Enter the flow value from your standard device into the STD field using the arrow keys, then press the CAL soft key.

**NOTE:** *The BAM flow reading will not change to match the STD until after you have entered all three flow calibration points, since it is done on a slope.*

6. Press the NEXT key to select the second flow point of 18.4 L/min. Allow the flow to stabilize again, then enter the value from your standard device and press the CAL key.

**NOTE:** *If the APDA-371 is unable to achieve flow regulation at the 18.4 L/min point, this could be an indication that the vacuum pump needs to be serviced.*

7. Press the NEXT key to select the third flow point of 16.70 L/min. Allow the flow to stabilize again, then enter the value from your standard device and press the CAL key.

8. After this third flow point is calibrated, the BAM flow reading will change to show the corrected flow, then the APDA-371 will quickly re-regulate the flow to 16.70 L/min based on the new calibration. The APDA-371 flow reading should now match your flow standard device at  $16.70 \pm 0.1$  L/min.

9. Exit the calibration menu.

### **Resetting Flow Calibrations:**

If the APDA-371 flow, temperature, or pressure readings do not correctly change to match your standard device during the above calibration process, or if multiple calibrations are required in order to get a good match, then the APDA flow calibrations may need to be reset. This case has sometimes been observed during the first flow calibration after a APDA-371 firmware update.

Select a parameter and press the DEFAULT soft key to clear out all previous calibration factors from that parameter and replace them with the original factory calibration factor. Default all of the AT, BP, and flow parameters, then try again to calibrate them to your standards. You may also need to reset the filter RH and filter temperature sensor calibrations. The default factory calibration factors should be very close to the correct values.

### **Actual flow calibrations in units with older firmware:**

APDA-371 units with previous revisions of firmware (prior to 2.58) have a different format in the TEST > FLOW menu, as shown below. These units are flow calibrated in the same way as described above, except that the flow calibration is performed at only a single point of 16.7 lpm, not a multi-point calibration as in new units. The correct values from your traceable reference standard device must be entered into the "REFERENCE" column, then the "ADJUST/SAVE" button is pressed to correct the APDA reading. The "NEXT" key selects the parameter to be calibrated. AT and BP must be calibrated first, then the pump is turned on.



| ACTUAL FLOW CALIBRATION MODE |          |           |      |
|------------------------------|----------|-----------|------|
| F1= RESTORE DEFAULT          |          |           |      |
|                              | BAM      | REFERENCE |      |
| AMBIENT TEMPERATURE:         | 23.8 C   | 23.4 C    |      |
| BAROMETRIC PRESSURE:         | 741 mmHg | 742 mmHg  |      |
| VOLUMETRIC FLOWRATE:         | 16.7 lpm | 16.9 lpm  |      |
| ADJUST/SAVE                  | NEXT     | PUMP ON   | EXIT |

**Previous Format of the Actual Flow Calibration Screen**

## 5.9 Field Calibration of Flow System – Standard Flow Mode

All APDA-371 monitors configured according to EN requirements are set with a FLOW TYPE of ACTUAL, and must be calibrated as described above in Section 5.8. If the APDA-371 must be operated in standard flow mode, see below:

### FLOW TYPE: STD with a Temperature Sensor:

If the APDA-371 is an older PM10 unit without a separate CONC TYPE setting, or if the operational FLOW TYPE must be set to STANDARD for some special reason, then the easiest way to calibrate the flow is to temporarily change the FLOW TYPE from STD to ACTUAL in the SETUP > CALIBRATE menu, then perform a normal actual flow audit or calibration as described above. If this method is used, be sure to set the APDA-371 back to STD flow type when finished. This works as long as the APDA-371 is equipped with an ambient temperature sensor on input channel six.

## 6 SETUP MENU DESCRIPTIONS

The APDA-371 uses a comprehensive system of setup menus which contain all of the settings and parameters needed to perform the measurement and operation of the unit. Some of these settings are set at factory default values which are correct for most applications, but may be altered by the operator to suit the specific needs of your monitoring program. This section describes the SETUP menu in detail, and should be reviewed when the instrument is put into service to ensure desired operation. Once set, most of the values in the SETUP menus will not need to be changed by the site operator. The SETUP values will not be lost if the unit is unplugged or powered down.



**CAUTION:** Some of the settings in the SETUP menus are unit-specific calibration constants which cannot be changed without affecting the accuracy and proper operation of the unit.



**CAUTION:** Entering the SETUP menu system will require stopping the sample cycle. Older versions of firmware will not warn you before stopping the sample!

Press the SETUP soft-key to enter the menu as shown below. The Setup Menu provides a choice of operations. Use the arrow keys to navigate to the desired field, then press the SELECT soft-key to enter.

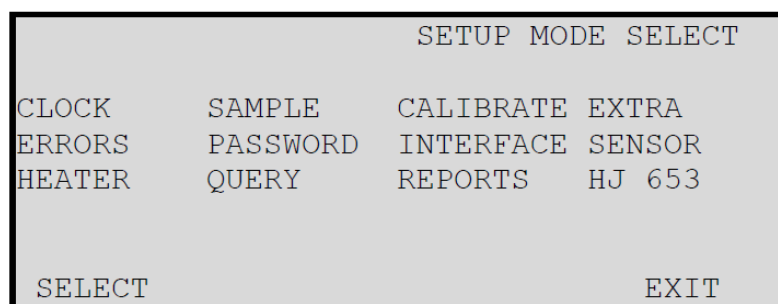

The SETUP Menu

A brief description of each sub-menu is shown in the table below. Detailed information is provided in the following sub-sections.

| Menu             | Settings  |
|------------------|---|
| <b>CLOCK</b>     | APDA-371 real-time clock date and time settings.  |
| <b>SAMPLE</b>    | Range, Offset, Sample Time, Count Time, Conc. Units, Avg Period, Unit ID, and RS-232 settings.                      |
| <b>CALIBRATE</b> | Factory Calibration Values, (C <sub>v</sub> , Q <sub>0</sub> , ABS, μsw, K, BKGD) Flow rate, Flow type, Conc. type. |
| <b>EXTRA1</b>    | Low concentration clamp, e1 – e4, Rarely used.  |
| <b>ERRORS</b>    | Analog error selections, Flow limits, Pressure drop limit.  |
| <b>PASSWORD</b>  | Password change screen.   |
| <b>INTERFACE</b> | Cycle Mode early/standard, alarm relay polarity.  |
| <b>SENSOR</b>    | Meteorological sensor scaling and configuration screens, Channels 1 – 6.  |
| <b>HEATER</b>    | RH set-point for Smart Heater.  |
| <b>QUERY</b>     | Configuration for the custom Query data output file, and the EU Bayern-Hessen protocol                              |
| <b>REPORTS</b>   | Daily data report hours, BP and Reference membrane logging options  |
| <b>HJ 653</b>    | Data format compliance with Chinese HJ 653-2013 standard  |

## 6.1 CLOCK Setup Screen

The SETUP > CLOCK screen allows for the setting of the time and date. Time is a 24-hour clock only. Use the arrow keys to select and increment/decrement the desired field, then press the SAVE soft-key. The APDA-371 clock may drift as much as a minute or two per month. HORIBA recommends checking the clock monthly to ensure correct sample timing.

## 6.2 SAMPLE Setup Screen – Important Information



The SETUP > SAMPLE screen is used to set the APDA-371 sampling and averaging periods, and some other important settings. Review each of these settings carefully. The SAMPLE screen is shown below. The fields can be edited with the arrow keys, then saved with the SAVE soft-key.

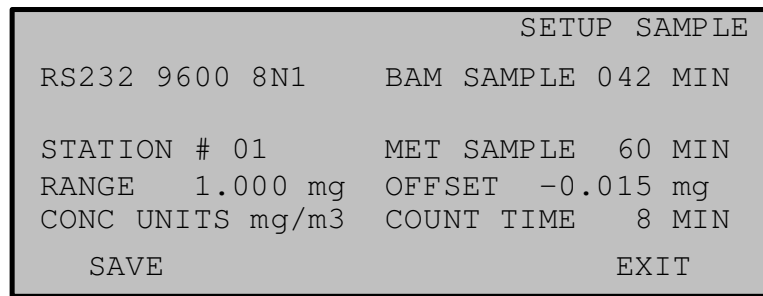

The SAMPLE Screen

### RS-232:

This allows you to set the baud rate of the RS-232 serial port. The available values are 300, 600, 1200, 2400, 4800, 9600, 19200, and 38400 baud. The default setting is 9600 baud. The APDA-371 must be set to 9600 baud during flash firmware upgrades, but may be set faster for data collection. The handshaking settings “8N1” means 8 data bits, no parity, 1 stop bit. These cannot be edited.

### BAM SAMPLE:

This value sets the amount of time that the vacuum pump is on per cycle; the actual sample period (see Section 4.1 for a description of the measurement cycle). The BAM SAMPLE time must be set in response to the COUNT TIME value, since new versions of the APDA-371 allow the option of setting the count time to 4, 6, or 8 minutes. If the unit is used for PM<sub>2.5</sub> monitoring, the BAM SAMPLE must be set to 42 minutes with 8 minute count time. PM<sub>10</sub> monitors are almost always set for 50 minutes.

| Count Time   | BAM Sample    | Used for  |
|--------------|---------------|---|
| <b>4 min</b> | <b>50 min</b> | PM10 monitoring, units without a count time setting |
| <b>8 min</b> | <b>42 min</b> | PM2.5 monitoring (FEM & EU)                         |

The BAM SAMPLE value can be set from 0-200 minutes for custom applications. If set for shorter period, such as 15 minutes, the unit will finish the sampling in 15 minutes and then wait until the end of the hour before beginning a new cycle. This may not leave time for the membrane span check. Only one cycle per hour is allowed, regardless of duration. Setting the BAM SAMPLE value too long may cause the total measurement cycle to overlap into the next hour, so that the APDA-371 only collects the concentration every second hour. Contact the Service department before setting this to anything but the values shown in the table.

### INLET TYPE:

This setting helps users identify whether the APDA-371 is collecting TSP, PM10, or PM2.5 data. Whichever option is selected sets the corresponding label to be displayed at the top of the main menu screen. This setting is for providing indication on the display only and does not impact any of the actual data collection or reports.

### STATION #:

This is a station identification number. This number has a range of 001-254, and will be included in the data reports. When used in a network, every APDA-371 should be given a different station number. Default value is 01.

### MET SAMPLE:

This value is the averaging period for the built-in met sensor data logger. It sets how often the data array is averaged and written to memory, and can be set to 1, 5, 15, or 60 minutes. For example, if an optional wind speed sensor is attached to the APDA-371, the MET SAMPLE period could be set to 1 or 5 minutes. This value applies to all parameters and sensors attached to the APDA-371, except for the dust concentration data which is always an hourly average regardless of this setting.



**CAUTION:** This setting will affect how long the memory will last before getting full.

There are **4369 records** available in the APDA memory. The default MET SAMPLE period of 60 minutes (1 record per hour) will result in over 182 days worth of memory capacity, but a 1 minute average period will fill up these memory records in only 3 days. When the memory gets full the unit over-writes the oldest data. HORIBA recommends leaving the MET SAMPLE period set at the default value of 60 minutes unless otherwise required for a particular application. The dust concentration value will always be an hourly average regardless of this setting.

| MET SAMPLE | Data Capacity |
|------------|---------------|
| 60 min     | 182 days      |
| 15 min     | 45 days       |
| 5 min      | 15 days       |
| 1 min      | 3 days        |

### RANGE:

The RANGE setting sets the full-scale range of the concentration measurement system of the analog voltage output. The APDA-371 internal digital data logger range will vary depending on the DYNAMIC RANGE setting (see section 6.11.2). The RANGE value is usually kept at the default setting of 1.000 mg, with a default OFFSET (lower limit of the range) of -0.015 mg. This means that the APDA measures a maximum full-scale range of  $-0.015 \text{ mg} + 1.000 \text{ mg} = 0.985 \text{ mg}$  by default. The table below shows some examples of how the RANGE and OFFSET setting interact to produce the concentration data outputs..

| OFFSET Setting | RANGE Setting | Dynamic Range Setting | Resulting Digital Data Range | Resulting Analog Output Range |
|----------------|---------------|-----------------------|------------------------------|-------------------------------|
| -0.015 mg      | 1.000 mg      | STANDARD              | -0.015 to 0.985 mg           | 0-1V = -0.015 to 0.985 mg     |
| -0.005 mg      | 1.000 mg      | EXTENDED              | -0.005 to 9.995 mg           | 0-1V = -0.005 to 0.995 mg     |
| -0.015 mg      | 0.200 mg      | EXTENDED              | -0.015 to 9.985 mg           | 0-1V = -0.015 to 0.185 mg     |
| 0.000 mg       | 1.000 mg      | STANDARD              | 0.000 to 1.000 mg            | 0-1V = 0.000 to 1.000 mg      |
| -0.015 mg      | 2.000 mg      | STANDARD              | -0.015 to 1.985 mg           | 0-1V = -0.015 to 1.985 mg     |

The RANGE value may be set to 0.100, 0.200, 0.250, 0.500, 2.000, 5.000, or 10.000 mg.



*It is important to understand this setting if an external data logger is used to log the APDA-371 analog output, since the data logger must be set to scale the analog voltage correctly. See Section 8.*

**NOTE:** Changing the range setting will affect past data already stored to memory. Always download any old data before changing settings, then clear the memory. Firmware version 3.2.4 or later will require you to clear the memory before letting you change this setting.

**OFFSET:**

The OFFSET value is used to set the lower end of the APDA-371 concentration range for both the analog output and internal digital ranges. The factory default value for OFFSET is -0.015 mg, which is the recommended setting. When set this way the APDA-371 can report from -.015 mg (0.0 V) to .985 mg (1.0 V).

**NOTE:** Changing the offset setting will affect past data already stored to memory. Always download any old data before changing settings, then clear the memory. Firmware version 3.2.4 or later will require you to clear the memory before letting you change this setting.

**CONC UNITS:**

This setting determines the concentration units which the APDA-371 displays and stores in memory. This can be set to µg/m³ (micrograms) or mg/m³ (milligrams) per cubic meter. This is a new option for the APDA-371. Past versions have always been set for mg/m³ and this is still the default setting.

**NOTE:** 1 mg = 1000 µg.

**COUNT TIME:**

This is the amount of time the unit takes to perform the I<sub>0</sub> and I<sub>3</sub> counts. Settings are as follows:

| Count Time | BAM Sample | Used for  |
|------------|------------|---|
| 4 min      | 50 min     | PM10 monitoring, units without a count time setting |
| 8 min      | 42 min     | PM2.5 monitoring (FEM & EU)                         |

See the BAM SAMPLE setting description above, and Section 4.1. The APDA-371 will prompt you to change the BAM SAMPLE time setting if you change the COUNT TIME to an incompatible value.

**6.3 CALIBRATE Setup Screen – Important Information**



The SETUP > CALIBRATE screen is where most of the factory-determined calibration parameters for the APDA-371 are stored. These values are unit-specific, and can also be found on the calibration certificate for the unit in case a setting is accidentally changed. Most of these settings will never be changed without specific information from HORIBA. It is good practice to periodically audit the calibration values to verify that they have not been altered. The CALIBRATE screen is shown below.

| CALIBRATE SETUP   |                   |
|-------------------|-------------------|
| CONC TYPE: ACTUAL | FLOW RATE: 16.7   |
| Cv: 1.047         | FLOW TYPE: ACTUAL |
| ABS: 0.822        | Qo: 0.000         |
| K: 1.005          | µsw: 0.306        |
| STD TEMP: 25C     | BKGD: -0.0030     |
| SAVE              | HEATER: AUTO      |
|                   | EXIT              |

**The SETUP > CALIBRATE Screen**

**SPAN CHECK:**

This setting determines how often the APDA-371 performs the automatic span membrane check. If the value is set to 1 HR, the APDA-371 measures and displays the span each hour. If this value is set to 24 HR, then the APDA will only

perform the span check once per day during the sample hour beginning at midnight and during any sample hour following a power failure. The resulting value will be displayed throughout the rest of the day. If this value is set to OFF, the span check will be disabled entirely.

**NOTE:** *This setting does not appear in any firmware before V3.7.0, where the setting is invisible and fixed at hourly.*

#### **FLOW RATE:**

This sets the air flow rate for the APDA-371 sample period. The APDA will continuously regulate the flow to this value (except manual valve models). The flow rate is almost always set for **16.7 liters per minute**, as this is required for all PM<sub>2.5</sub> and PM<sub>10</sub> monitoring. The operator may change this value temporarily in order to test the ability of the pump and flow controller to regulate the flow at different levels. The range of this setting is 10 to 20 LPM.

#### **CONC TYPE:**

This sets the way that the concentration values are reported.



*The CONC TYPE has to be set to ACTUAL for all PM2.5 monitoring as well as PM10 monitoring in Europe. For other PM10 monitoring purposes, it is set mostly to STD.*

If set to ACTUAL, then the concentration is calculated based on the volume of the air at ambient conditions, and a BX-592 or BX-596 temperature sensor is required. If set to STD, the concentration is calculated based on the standard values for temperature and pressure (usually 25C and 760mmHg), even if a temperature sensor is available.

**NOTE:** *APDA units with firmware prior to rev 3.0 does not have this setting available and the concentration reporting is determined by the FLOW TYPE setting.*

#### **FLOW TYPE:**

This setting selects the flow control scheme used by the APDA-371. The options are ACTUAL or STD. **Section 5.3 contains a detailed description of each of these flow types**, and should be studied to ensure proper operation of the APDA-371.



*The FLOW TYPE should be set to ACTUAL on all APDA-371 monitors equipped with an external temperature sensor (BX-592, BX-596 or BX-597). FLOW TYPE should be set to STD only if an external temperature sensor is unavailable.*

#### **Cv:**

This value is a factory-set scaling slope for the internal mass flow sensor. The value of Cv is never altered except when performing a flow calibration on old units without an automatic flow controller. All newer units with flow controllers and ambient temperature sensors never need to have this value altered, because the flow calibrations are done in the TEST > FLOW screen.

#### **Qo:**

This value is the factory-set zero correction offset for the internal mass flow sensor, and is almost always zero. Qo is usually never changed by the user except when troubleshooting a leak check failure if the APDA flow display does not drop to 0.0 L/min when the pump tubing is disconnected from the APDA-371.

#### **ABS:**

The ABS value is the factory-set mass of the reference membrane foil used during the automatic span check. This value is compared to the measured value each hour (see section 4.2). Each unit's ABS value is different, but is typically around 0.800 mg/cm<sup>2</sup>.



*The ABS value is never changed by the operator unless the span membrane is replaced due to damage.*

**μsw:**

This is called the -switch value, and is the factory-set mass absorption coefficient used by the APDA-371 in the concentration calculations. The value is typically around 0.3 and may vary slightly from one APDA-371 to the next. Older units before 2007 had a μsw-value near 0.285.

**K:**

K is the factory-set, instrument specific calibration factor for the APDA-371 concentrations. K is determined by running the APDA-371 against a calibration standard while both are sampling from a smoke chamber over a wide variety of concentrations. K ranges typically from 0.9 to 1.1.

**BKGD:**

BKGD is used to compensate for measured mass concentration output in the absence of PM. It is determined by operating a APDA-371 for several days (48-72 hours) in the absence of PM (achieved by equipping the APDA-371 inlet with a HEPA-filter). The average mass concentration of the 48 or 72 1-hour readings multiplied by -1 will be the calculated BKGD. With a properly set BKGD a APDA-371 making multiple readings of air with zero PM should read on average 0 μg/m<sup>3</sup>.

**STD TEMP:**

This is the value of standard temperature, used for standard flow or concentration calculations. In the U.S. the value of standard temperature is usually 25 degrees C as mandated by the USEPA. Some other countries use a standard temperature value of 0C or 20C. This setting is not available on units using firmware prior to rev 3.0.

## 6.4 EXTRA1 Setup Screen

The settings in the EXTRA1 screen are special settings for specific unusual applications and must not be changed under normal sampling conditions. Below is a brief explanation of these settings and the factory set values. These settings should never be modified without first consulting HORIBA for guidance.

- e1** Low Concentration Limit: This is the lowest concentration value the APDA-371 is allowed to store or display and must always be set to match the OFFSET value in the SETUP > SAMPLE menu. The default value is -0.015 mg.
- e2** Not used: The default value is 0.500.
- e3** Membrane OFF Delay: The default value is 0.000.
- e4** Membrane Time Out: The time the APDA-371 allows for the membrane assembly to move before generating an error. The default value is 15.00 seconds.





The following settings related to the alarms are located in the SETUP > ERRORS screen:

#### **AP Pressure-drop limit.**

This is the maximum amount of increase in pressure drop which is allowed to occur across the filter tape due to heavy dust loading, before the “P” alarm will be generated. Setting the AP higher will allow more dust to accumulate before the sample is terminated, but may cause flow regulation problems. See the pressure-drop alarm description in Section 7.2. The default setting of **150 mm Hg** is correct for most applications using the standard Medo or Gast pumps. Larger pumps can accommodate a higher AP setting and higher dust loads while still being able to regulate the sample flow. The setting range is 0-500 mm Hg.

The **CONCENTRATION ERROR** field determines what is logged, displayed, and reported whenever one of the major alarm types that affects the concentration calculation is present. Minor alarms such as E, U, R, P, or D do not trigger this behavior and will still record the actual concentration value. There are three choices: FULL SCALE VALUE, MIN SCALE VALUE, and “ERROR” TEXT.

#### **FULL SCALE VALUE**

The full scale concentration value (typically 0.985 mg) will be displayed on the APDA-371 front panel screen, stored in the data file, included on all data reports, and output on the analog output terminals.

#### **MIN SCALE VALUE**

The minimum scale concentration value (typically -0.015 mg) will be displayed on the APDA-371 front panel screen, stored in the data file, and included on all data reports. The full scale value will still be output on the analog output terminals.

#### **“ERROR” TEXT**

The full scale concentration value (typically 0.985 mg) will be output on the analog output terminals. The word ERROR will be displayed in place of the concentration value on the Main Menu, Normal, Instantaneous, and Average screens. See section 3 for more information about these screens. The word ERROR will also be stored in the data file and printed in place of the concentration value in the Daily and CSV reports.

## **6.6 PASSWORD Setup Screen**

The SETUP > PASSWORD screen allows the program administrator to change the password required to enter many of the SETUP menus. The password prevents untrained users from accidentally changing critical settings on the unit. The password can be any 4-key combination of the six function keys, F1 to F6. The default password is **F1, F2, F3, F4**. HORIBA does not recommend changing the password unless truly necessary. Contact the HORIBA Service department for instructions if the password is lost or forgotten.

## 6.7 INTERFACE Setup Screen

The SETUP > INTERFACE screen is shown below. These settings are used to configure the APDA-371 for operation with an external data logger recording the analog output. Most of these settings are rarely used, but the Cycle Mode setting must be reviewed if the analog output is being used.

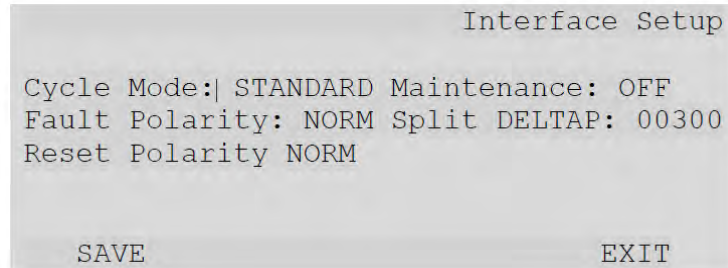

The INTERFACE screen

### Cycle Mode:

The Cycle Mode can be set to STANDARD or EARLY. If you are not using the analog output voltage of the APDA-371, leave this set to STANDARD. See Section 8.2.

### Maintenance:

This can be used to manually toggle the “M” digital maintenance flag and the maintenance relay on the back of the APDA-371 ON or OFF. This can be useful to flag data when performing the zero filter test or testing that will affect the data integrity. It will also display the words MAINTENANCE MODE on the Main Menu screen. The Maintenance flag can be toggled on and off remotely using the <ESC>MN serial command.

### Fault Polarity:

This sets the polarity of the Telemetry Fault Relay input. NORM is normally open, INV is normally closed. Almost never used.

### Split DELTAP:

Not used.

### Reset Polarity:

This tells the APDA-371 the incoming polarity of an external clock reset signal, if used. This signal is used to synchronize the APDA-371 clock to an external data logger. NORM is normally open, INV is normally closed. Almost all data loggers use normal open polarity for the signal.

## 6.8 SENSOR Setup Screen

The SETUP > SENSOR menu is where configurations and setup parameters are located for the six analog input channels used to log external meteorological sensors. Each channel must be configured to accept the sensor before data can be acquired. Description for the parameters are provided below. There is a separate configurable setup screen for each of the six external sensor inputs in the SETUP > SENSOR menu. There are also two internal channels (I1 concentration and I2 flow volume) which can be viewed but not modified.

BX-500 series meteorological sensors have an Auto ID feature which allows the APDA to automatically recognize the sensor and enter all of the setup parameters for any channel the sensor is attached to. The six channels can also be manually configured for other sensors. Almost any meteorological sensor with a voltage output range of 1.0 or 2.5 volts can be scaled and logged by the APDA-371.

| SETUP CHAN PARAMS |      |               |      |              |        |
|-------------------|------|---------------|------|--------------|--------|
| CH                | TYPE | UNITS         | PREC | MULT         | OFFSET |
| 06                | AT   | C             | 1    | 0100.0       | -050.0 |
| SENSOR FS VOLT:   |      |               |      | 1.000        |        |
| INV SLOPE:N       |      | VECT/SCALAR:S |      | MODE:AUTO ID |        |
| SAVE              |      | ID MODE       |      | EXIT         |        |

### The SENSOR Menu

- CH:** This field selects the channel to be viewed or edited. Use the up/down arrow keys to select the desired channel.
- TYPE:** This is the channel name. You can enter any desired name here by using the arrow keys to scroll through the alphabet and other ASCII characters.
- UNITS:** This is the measurement units label for the channel. You can enter a value here by using the arrow keys to scroll through the alphabet and other characters.
- PREC:** This is the precision field, which sets the number of available decimal places for the Multiplier and Offset parameters.
- MULT:** This is really the measurement range or the span of the sensor. If a baro sensor has a range of 525 to 825 mmHg, then the MULT would be 300 (mmHg). If a RH sensor has a range of 0 to 100%, then the MULT would simply be 100 (%).
- OFFSET:** This is the range offset value, or the measurement value that the sensor represents at 0.000V output. In the screen shown above, the AT sensor has a 0-1V output representing -50 to +50°C. So the MULT range is 100 (C) and the offset is -50, because 0.000V from the sensor represents -50°C.
- FS VOLT:** This is the full-scale voltage output of the sensor. The maximum voltage range that can be supplied by the sensor. This value is usually going to be either 1.000 or 2.500 volts. 2.500 is the maximum setting for this field.
- INV SLOPE:** This setting allows the channel to recognize a sensor with an inverse slope. This is always set to **N** (no) except for use with thermistor temperature sensors with resistance-only outputs.
- VECT/SCALAR:** This value sets the averaging method. **S** (scalar) is used for all measurements except wind direction, which uses **V** (vector).
- MODE:** This field is toggled by pressing the ID MODE soft-key. The value can be set to either MANUAL or AUTO ID. In MANUAL mode, the user can enter their own setup parameters for the channel. AUTO ID mode is used with 500 series sensors, and must be selected in order for the unit to recognize the sensor automatically.

**NOTE:** Any manually set parameters for that channel will be lost when changing to AUTO ID mode. Channel 6 must be set to AUTO ID for all APDA-371 monitors equipped with an ambient temperature sensor.

## 6.9 HEATER Setup Screen

The SETUP > HEATER screen is only visible if the HEATER CONTROL mode in the SETUP > CALIBRATE menu is set to AUTO. This menu is used to configure the settings used by the APDA-371 to control the Smart Inlet Heater. The APDA-371 uses an RH and temperature sensor located below the filter tape in the sample air stream to monitor the conditions of the air as it is being sampled. If the measured relative humidity of the sampled air stream is higher than about 50% then PM measurements might be skewed higher those produced from a collocated reference sampler. The Smart Heater can reduce this effect by actively heating the inlet tube by warming the sampled air stream whenever the RH value measured downstream of the filter tape exceeds a user selectable value.

It should be noted that the relative humidity downstream of the filter tape is not necessarily the same as the ambient relative humidity. Relative humidity is a measure of how much moisture the air is holding compared to how much moisture the air can hold (dew point) and is strongly temperature dependent. For example, if the ambient relative humidity is 50% and the ambient temperature is 3°C, the relative humidity downstream of the filter tape would be about 22 % were the filter temperature 15°C, which means that the Smart Heater would not have to apply additional heat were the APDA-371 to be operated inside of a temperature-controlled enclosure set maintain an instrument temperature of about 20 °C in order to maintain the filter temperature RH value of 35%.

```
HEATER SETUP
HEATER MODE: AUTO
FRH CONTROL: YES
FRH SETPOINT: 35 %
LOW POWER: 20 % ( 06)
LOG FILTER-RH: YES (CHAN 4)
LOG FILTER-T: YES (CHAN 5)
SAVE                               EXIT
```

The HEATER Setup Screen

### Heater Mode:

This setting selects which operation mode the Smart Inlet Heater uses to control RH.



*This value must be set to AUTO for all PM2.5 and PM10-monitoring.*

When set to AUTO, the Smart Heater uses the filter RH sensors to control the inlet tube heating. For most sampling conditions, HEATER MODE should not be set to MANUAL.

### FRH Control:

If YES is selected, the Smart Heater will be automatically turned on full power whenever the humidity of the sample stream exceeds the RH Set point. When the RH falls back below the set point, the heater turns down to a low power heat mode which applies only slight heating. If this is set to NO, The Smart Heater will stay in low power mode and no additional RH control will be performed.

**FRH Set point:**

This is the relative humidity level that the filter will be regulated at or below by the inlet heater.

The RH set point is set to 45% for European (EU) PM2.5 and PM10 units

The RH set point is set to 35% for the version of the APDA-371 employing the smart heater when operated as a PM2.5 US-EPA designated federal equivalent method. Otherwise it may be either 35% or 45% for PM10 units.

The RH set point is otherwise adjustable from 10% to 99%.

**Low Power:**

This is the power level of the smart heater when the Filter RH value is below the FRH setpoint.

**Log Filter-RH:**

Turns logging of the Filter RH value on and off. When set to ON, the Filter-RH value will be logged on analog input channel 4.

**F Log Filter-T:**

Turns logging of the Filter Temperature value on and off. When set to ON, the Filter-T value will be logged on analog input channel 5.

**Datalog RH:**

If YES is selected, the filter RH values will be logged on channel 4 of the APDA-371. Select YES if you do not have any external sensors attached to channel 4.

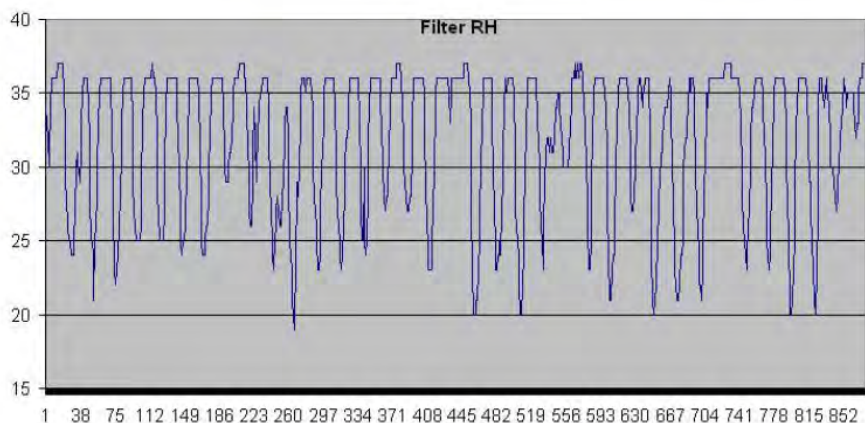

**Properly Regulated Channel 4 Hourly Filter RH Graph**

## 6.10 QUERY Setup Screen – Custom Data Array Setup

The SETUP > QUERY screen allows the user to configure a custom digital data array for the new Query Output, or for the European BH Bayern-Hessen protocol. The user can select exactly which data parameters appear in the array, and in what exact order they appear. The custom array can be as simple as a single concentration value, or it can be very comprehensive including some parameters that are not even available in any of the standard data files, such as the hourly span membrane check value. The setup of this custom array does not affect any of the standard APDA-371 data arrays. The query output is available in firmware revisions 3.6.3 and later and requires the Report Processor. The BH protocol is available in revision 5 series European firmware. A separate technical document for the Bayern-Hessen protocol functions is also available. See Section 9.9 for instructions about how to retrieve the Query output files.

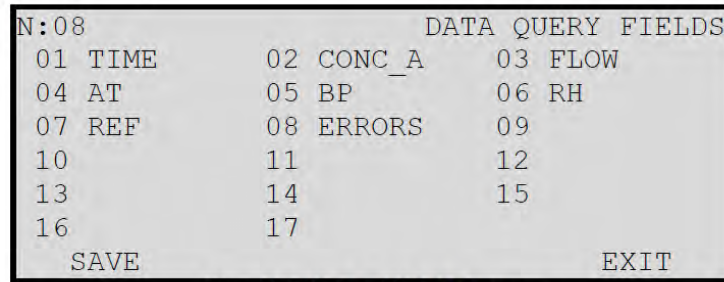

The SETUP > QUERY Screen

The **N:** field sets how many values to include in the array. Up to 17 parameters can be included. Increment the N value with the up/down arrow keys. For each increment of the N value, another position in the array will be activated, starting with position 01.

Each position in the array can be changed to any desired parameter using the left/right keys to select the position, and the up/down keys to scroll through the whole list of parameters. In the example above, eight parameters are included and the shown parameters were selected for each of the eight positions in the array. The available parameters are listed in the table below:

| Parameter       | Description  |
|-----------------|--|
| <b>CONC_A</b>   | Concentration value for the last sample period.  |
| <b>Q_STD</b>    | Sample flow volume in cubic meters at standard conditions.   |
| <b>Q_ACT</b>    | Sample flow volume in cubic meters at actual AT/BP conditions.                                       |
| <b>STAB</b>     | Stability measurement. Diagnostics use only. EU firmware only.                                       |
| <b>REF</b>      | Reference span membrane mass measurement in mg/cm <sup>2</sup> .                                     |
| <b>FLOW</b>     | Real time flow or average flow for the last sample.  |
| <b>CV</b>       | Flow coefficient of variability for the last sample period. (Standard deviation divided by the mean) |
| <b>AT</b>       | Average ambient temperature for the sample period.   |
| <b>BP</b>       | Average barometric pressure for the sample period.   |
| <b>ANALOG 1</b> | Average of analog met sensor channel 1 (user defined channel).                                       |

|                 |   |
|-----------------|---|
| <b>ANALOG 2</b> | Average of analog met sensor channel 2 (user defined channel).  |
| <b>ANALOG 3</b> | Average of analog met sensor channel 3 (user defined channel).  |
| <b>ANALOG 4</b> | Average of analog met sensor channel 4 (usually filter RH).   |
| <b>ANALOG 5</b> | Average of analog met sensor channel 5 (usually Delta T).   |
| <b>ANALOG 6</b> | Average of analog met sensor channel 6 (almost always AT).  |
| <b>CONC_S</b>   | PM10 concentration using standard conditions. Used in PM-coarse systems where the coarse PM10 value is in actual conditions, but the standard PM10 value is also needed for regular PM10 reporting requirements. This parameter is only available in the PM10 master unit of a coarse set |
| <b>PM2.5</b>    | PM2.5 concentration from the slave unit in a PM-coarse. This parameter is only available in the master unit of a coarse set.  |
| <b>PMc</b>      | PM-coarse (PM10 - PM2.5) concentration value. This parameter is only available in the master unit of a coarse set.  |
| <b>TIME</b>     | Date and Time stamp for the sample period. Ignored for BH protocol.   |
| <b>ERRORS</b>   | Decimal error codes of the 12 major error categories.   |

## 6.11 REPORTS Setup Screen – Daily Data and Dynamic Ranges

The SETUP > Reports screen provides options for setting the hours of the daily data average period and the type of dynamic range being used.

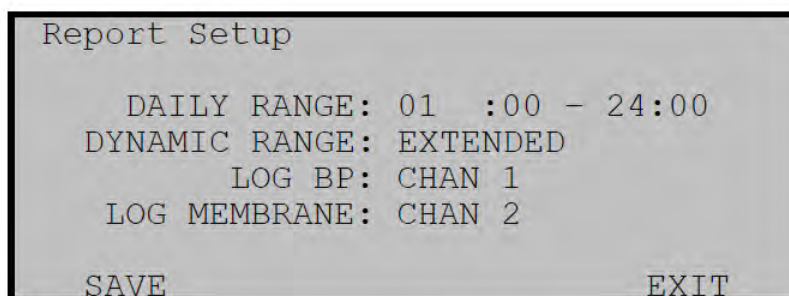

The REPORTS Setup Screen

### 6.11.1 Daily Data Range

The DAILY RANGE field is used to select which hours are included in the daily APDA-371 data file reports. The two possible choices are:

**00:00 to 23:00** (old default setting) or **01:00 to 24:00** (correct newer setting)

The APDA-371 time stamp is the end of the sample hour, not the beginning, so the 01:00 data point is for air sampled between midnight and 1:00 am. Always select 01:00 to 24:00 unless the monitor is being used in a special application requiring 00:00 to 23:00.

## 6.11.2 Dynamic Range

The DYNAMIC RANGE field is used to choose the range of the concentration value being stored in the data logger. The two possible choices are **STANDARD** or **EXTENDED**.

Both settings will utilize the same OFFSET value configured in the SETUP > SAMPLE screen. See section 6.2 for details on setting the OFFSET value.

The STANDARD range sets the logger scaling to match the analog output range as determined using the RANGE setting in the SETUP > SAMPLE screen. See section 6.2 for details on setting the RANGE value.

Choosing the EXTENDED range forces the logger scaling to be 10 mg, regardless of the analog output RANGE setting. The EXTENDED range is automatically selected when setting the HJ 653 option (see section 6.12) to YES.

Most locations will use the STANDARD range. However, areas with heavy concentrations (or where local regulations may require it) should use the EXTENDED option.

**NOTE:** *Changing this setting will clear all data stored in memory. Be certain to download and save any collected data prior to changing the range.*

## 6.11.3 Log BP

The ambient barometric pressure measurement on analog input channel 7 can be logged on channel 1, 2, or 3. This setting can also be set to NONE if it is not desired to log ambient barometric pressure.

## 6.11.4 Log Membrane

The results of the reference membrane measurement can be logged on channel 1, 2, or 3. This setting can also be set to NONE if it is not desired to log these test results.





## 7 MAINTENANCE, DIAGNOSTICS and TROUBLESHOOTING

This section provides information for maintaining your APDA-371, and for performing diagnostic tests if a problem is encountered. If the unit generates errors on the display or in the data array, first check Section 6.5 to identify the error. Many times there is a simple solution. Persistent errors often signify a failure or impending failure which will require investigation.

### 7.1 HORIBA Suggested Periodic Maintenance

| Maintenance Item   | Suggested Period                             |
|--|--|
| Nozzle and vane cleaning*  | Monthly                                      |
| Leak check*  | Monthly                                      |
| Flow system check/audit  | Monthly                                      |
| Clean capstan shaft and pinch roller tires*                                  | Monthly                                      |
| Clean PM10 inlet and PM2.5 cyclone   | Monthly                                      |
| Clean PM2.5 inlet  | Monthly                                      |
| Download and save digital data log and error log*                            | Monthly                                      |
| Compare APDA-371 data to external datalogger data (if used)                  | Monthly                                      |
| Check or set APDA real-time clock  |  |
|  |  |
| Replace filter tape roll   | 2 Months                                     |
| Run SELF-TEST function in the TAPE menu                                      | 2 Months                                     |
| Verify APDA-371 settings   | 2 Months                                     |
| Set Real-Time Clock  | 2 Months                                     |
| Full flow system audit and calibration                                       | 2 Months<br>(3 months according to EN 16450) |
|  |  |
| Replace or Clean Pump Muffler (if used)                                      | 6 months                                     |
| Test Pump Capacity   | 6 months                                     |
| Test Filter RH and Filter Temperature sensors                                | 6 months                                     |
| Test Smart Heater  | 6 months                                     |
|  |  |
| Perform 72 hour BKGD (BX-302 zero filter) test                               | 12 months                                    |
| Clean Internal Debris Filter   | 12 Months                                    |
| Check Membrane Span Foil   | 12 Months                                    |
| Beta Detector Count Rate and Dark Count Test                                 | 12 Months                                    |
| Clean Inlet Tube   | 12 months                                    |
| Test Analog DAC Output (if used)   | 12 Months                                    |
|  |  |
| Rebuild Vacuum Pump*   | 24 months                                    |
| Replace Nozzle O-ring (Special tools required)                               | 24 months                                    |
| Replace Pump Tubing  | 24 Months                                    |
|  |  |
| Factory Recalibration. Not required except for units sent for major repairs. | ---  |

\*These items may be performed more often as required.

## 7.2 APDA-371 Error and Alarm Descriptions

The following table describes the APDA-371 error and alarm codes. Errors are grouped into twelve categories. If an error or alarm occurs, it will appear at the end of the hourly digital data array as a simple “1” bit in one of the twelve error bit positions. This allows data collection systems to easily identify errors. See Section 9 for data examples. Errors and alarms are also stored in the separate APDA digital error log file, which contains more detail about the specific sub-category cause of the alarm.

**NOTE:** In general, any error which prevents the APDA-371 from making a valid, hourly concentration measurement will also cause the digital concentration value to be stored as a full-scale value (usually 0.985 mg) in order to indicate invalid data. |

In most cases, critical errors will also force the analog output to full-scale (1.00V). The rules for which errors cause invalid data and full-scale values have varied slightly with past revisions of firmware. The following descriptions explain these conditions in as much detail as possible. If an error occurs in your unit which does not seem to agree with this description, please note your firmware revision and contact Technical Service.

| Code     | Error / Alarm Type                                 | Error / Alarm Description   |
|----------|--|---|
| <b>E</b> | <b>External Reset<br/>or<br/>Interface Reset</b>   | This alarm indicates that an external data logger sent a clock synchronization signal to the APDA on the EXT RESET input, but the APDA was unable to reset its clock, because it occurred outside of the allowable time window. Hourly clock reset signals will be ignored by the APDA from minutes 5-54 (standard cycle) or minutes 0-49 (early mode). See Section 8.2. The alarm will also be generated if the synch signal occurs within the acceptable window near the end of the hour, but before the APDA has finished the previous concentration calculation. The digital error log will indicate which of these two has conditions occurred. If an external clock reset event is successful, then no alarm is logged. These alarms do not prevent the APDA from storing a valid data record for the sample hour.<br>Manually set the APDA-371 clock to match the data logger clock initially. This should cause subsequent clock synch events to succeed. Make sure the APDA lithium battery is functional. |
| <b>U</b> | <b>Telemetry Fault<br/>or<br/>Interface Fault</b>  | This alarm indicates that an external data logger has sent an error signal to the APDA-371 on the TELEM FAULT input, indicating that the logger unit has encountered a problem. This feature is almost never used. These alarms do not prevent the APDA from storing a valid data record for the sample hour.   |
| <b>M</b> | <b>Maintenance Alarm</b>                           | This alarm almost always indicates that the sample cycle was stopped because someone entered a SETUP or TEST menu for calibration or testing purposes. Maintenance flags always cause the digital concentration value to go full-scale for that hour, because the sample cycle was not finished.  |
| <b>I</b> | <b>Internal Error<br/>or<br/>Coarse Link Down</b>  | The “I” error is rare, and indicates that an error occurred in the APDA-371 concentration, mass, span, or stability calculation which prevented the generation of a valid concentration value. The digital error log will indicate which of these calculations has failed. The concentration value is set to full-scale due to invalid data. This may indicate a problem in the digital circuitry.  |
| <b>L</b> | <b>Power Failure<br/>or<br/>Processor Reset</b>    | This error occurs if AC input power is lost even momentarily, or if the power switch is turned off. Frequent “L” errors usually indicate poor quality AC power. If frequent power errors occur even when the APDA-371 is connected to a UPS backup system, contact HORIBA for instructions on possible power supply upgrades.<br>Anything that causes the microprocessor to reset will also result in an “L” error, such as low voltage on the 5.25V Vcc bus, bad connections on the internal DC power harness, or in rare cases electrical interference. All power failure errors cause the digital concentration value to go full-scale.  |
| <b>R</b> | <b>Reference Error<br/>or<br/>Membrane Timeout</b> | This error indicates that the span reference membrane assembly may not be mechanically extending or withdrawing properly. The error is generated if photo sensors S2 and S3 never change state after 15 seconds despite drive commands to the membrane motor. The digital error log will indicate which photosensor timed out. It may be a simple sensor/flag alignment problem that can be identified and corrected using the TEST > ALIGN menu. However, if the span foil assembly is stalled in a  |

|          |  |   |
|----------|--|---|
|          |  | partially extended position, it could block the beta signal and prevent valid data collection.  |
| <b>N</b> | <b>Nozzle Error</b>                                    | <p>This error indicates that the nozzle motor is not operating correctly. The error is triggered if photo sensors S4 and S5 never change state within 12 seconds, despite drive commands to nozzle motor. The concentration value is set to full-scale if the nozzle motor or sensors have failed. The digital error log will indicate which photosensor timed out.</p> <p><b>Important Note:</b> The nozzle sensors watch the motor cam rotation, not the actual action of the nozzle itself, so it is technically possible for the nozzle to become stuck in the UP position even if the motor and sensors indicate no error. This could result in a massive flow leak and useless data with no errors or alarms being generated! Proper maintenance of the nozzle O-ring and proper inlet alignment prevent this.</p>  |
| <b>F</b> | <b>Flow Error</b>                                      | <p>Flow errors can occur due to a fault with the flow controller, the flow sensor, or the vacuum pump. See section 7.5 for troubleshooting suggestions. The digital error log contains the exact subcategory which generated the alarm.</p> <p>The following minor flow alarms occur when a parameter was out of bounds, but the sample was not stopped. Concentration data is still stored normally</p> <ul style="list-style-type: none"> <li>- <b>5% out-of-regulation</b> - Flow &gt; 5% out of regulation for more than 5 minutes.</li> <li>- <b>AT Failure</b> – One minute average of the AT sensor was within 1 degree of the sensor min or max range. May occur in extreme cold or hot environments.</li> <li>- <b>Internal or External BP Failure</b> – One minute average of the barometric pressure sensor exceeded the min or max range of the BP sensor.</li> <li>- <b>Self-Test</b> – Self test flow rate less than 10 L/min.</li> </ul> <p>The following critical flow errors result in the sample being terminated and the concentration data being set to full-scale or as configured in the SETUP &gt; ERRORS menu (see section 6.5).</p> <ul style="list-style-type: none"> <li>- <b>AT Disconnected</b> - Missing or incorrectly connected AT sensor.</li> <li>- <b>Pump Off Failure</b> - Flow sensor indicates &gt;5 L/min with the pump turned off.</li> </ul> <p>This critical flow error results in the sample being terminated prematurely and the concentration being calculated with a smaller sample volume of air.</p> <ul style="list-style-type: none"> <li>- <b>Flow Failure</b> - Flow &gt; 10% out of regulation for more than 1 minute.</li> </ul> |
| <b>P</b> | <b>Pressure Drop Alarm or Delta-Pressure Alarm</b>     | <p>This error indicates that the pressure drop across the filter tape has exceeded the limit set by the “AP” value and is often due to heavy particulate loading. Current firmware will stop the sample early when this occurs, and make the concentration calculation based on the partial volume, then wait for the next hour. This feature is designed to stop the sample early if the vacuum capacity of the pump is about to be exceeded, before flow errors occur. Firmware before Rev 3.6.3 would not stop the sample for the “P” alarm, and subsequent flow errors could occur due very high concentration dust loading. The pump cycle must run for at least 5 minutes before a pressure drop alarm event can occur. See Section Fehler! Verweisquelle konnte nicht gefunden werden..</p>  |
| <b>D</b> | <b>Deviant Membrane Density Alarm or BAM CAL alarm</b> | <p>This error indicates that the reference membrane span check measurement (<b>m</b>) for that hour was out of agreement with the expected value (<b>ABS</b>) by more than <math>\pm 5\%</math>. These alarms are often caused by a dirty or damaged membrane foil. If the foil is clean and undamaged, the alarm could indicate that the beta detector tube itself is noisy or beginning to wear out, or that the membrane holder is not extending and withdrawing fully. These alarms do not prevent the APDA from storing a valid concentration for the sample hour because the dust mass is a completely separate measurement, but the alarm should be investigated and resolved in order to ensure proper beta detector operation.</p>   |
| <b>C</b> | <b>Count Error or Data Error</b>                       | <p>This error indicates that the beta particle counting system is not operating properly, and is activated if the beta count rate falls below 10,000 counts during any of the mass, membrane, or stability measurements. The 4-minute beta count rate through clean filter tape is usually more than 800,000 counts. This rare error occurs if the beta detector, high voltage, or digital counter has failed or if the beta signal is physically obstructed. This alarm sets the concentration value to full-scale.</p>  |

|          |   |  |
|----------|---|--|
|          |   | <p>The sub-category “count, failed” occurs if the beta counter is still counting 10 seconds after the scheduled end of any count period, indicating a digital fault.</p>   |
| <b>T</b> | <b>Tape System Error<br/>or<br/>Filter Tape Error</b> | <p>The tape error usually indicates that the filter tape is has run out or broken. It occurs if the right spring-loaded tensioner (tape roller nearest to the detector) is at the far left limit of its travel. In this case, tape break photosensor S6 is ON continuously, despite drive commands to the tape reel motors and the capstan motor. The tape error is also generated if the pinch rollers are latched in the up position when a new sample hour starts, preventing the cycle.</p> <p><b>NOTE:</b> <i>Firmware revision 3.6 and later will cause the concentration value to go to full-scale due to a tape error, because the cycle cannot be performed with broken tape. All previous firmware revisions did not set the concentration to full-scale, but instead repeated the last valid concentration value until the tape was replaced.</i></p> <p>In rarer cases, a tape error may also be generated due to a failure in the tape control electromechanical system. In current firmware there are several possible sub-categories for this error which will appear in the digital error log:</p> <ul style="list-style-type: none"> <li>- Tape, Latch – Pinch rollers latched up at cycle start.</li> <li>- Tape, Shuttle – Shuttle photosensor not responding to shuttle move.</li> <li>- Tape, Forward/Backward – Tape supply motor or take-up motor not responding.</li> <li>- Tape, Tension/Un-tension – Tensioner photosensor not responding.</li> <li>- Tape, Capstan – Capstan motor or capstan photosensors not responding.</li> <li>- Tape, Self-Test – Shuttle beam did not respond during self-test.</li> <li>- Tape, Break – Broken or empty tape.</li> </ul> <p>Tape errors caused by failures other than broken tape or latched pinch rollers can usually be identified using the TEST &gt; ALIGN menu to manually operate the motors and photosensors. See Section 7.18. Tape errors can be caused by grit in the shuttle beam ball slide. Contact tech service if the left/right shuttle slide action is not smooth.</p> |

### 7.3 Comparison of APDA-371 Data to Integrated Filter Sampler Data

Each new APDA-371 has been calibrated against a reference beta gauge whose calibration is traceable to a gravimetric standard. This calibration information is provided in the calibration certificate that accompanies each APDA-371 as K and as  $\mu\text{sw}$ . As the APDA-371 span response is virtually insensitive to the chemical composition of the sampled PM one should expect excellent agreement between mass density determined by a manual filter-based sampler and the mass density determined by a collocated APDA-371.

Most PM reference methods are based on manual, integrated sampling techniques in which PM is sampled onto pre-weighed filters. Sampled filters are then equilibrated and then re-weighed. The net weight gain is used along with the volume of air sampled to determine the mass density of PM in the sampled volume. PM reference methods may differ from one jurisdiction to another. Furthermore, the APDA-371 may be operated differently from one jurisdiction to another. For example, the APDA-371 may be configured to operate as a US-EPA designated PM<sub>2.5</sub> Federal Equivalent Method. Or it may be configured to operate in accordance with EU guidelines for PM<sub>2.5</sub>.

Users may collocate a PM10 or a PM2.5 reference sampler with a newly deployed APDA-371 and collect data on both devices for a period of time in order to demonstrate reasonable correlation and acceptable levels of multiplicative (slope) and additive (intercept) bias between the two methods. Performing such a field test is beneficial as it could reveal an undetected performance or data reporting issue. Common issues could include improper data logger scaling, incorrect background (BKGD) values, or improper flow calibration due to a mis-calibrated flow standard. A scatter plot between the reference standard results (plotted along the x-axis) and the APDA-371 results (plotted along the x-axis) can reveal these problems.

In order for such an analysis to be useful however it is necessary to have a suitable number of data points, an acceptable level of dispersion (range) in the measured values and acceptable level of correlation ( $r^2$ ) in a regression between the reference results and the APDA-371 measurements.

Below are several additional considerations:

- Nozzle leaks can lead to poor correlation between the APDA-371 and the reference standard.
- Improper inlet tube insulation or placing the APDA-371 directly in the path of an air conditioner vent during operation under hot, humid conditions can lead to poor correlation with the reference standard and unpredictable levels of multiplicative and additive bias.
- The collocated inlets should be at approximately the same height and within several meters of one another during the comparison test.
- The start time and the stop time of the filter-based method should correspond to the hourly APDA-371 measurement cycles.

## **7.4 Audit Sheet and Test Records**

The back of this manual contains a sample of a APDA-371 Audit Sheet. This is a test record which can be filled out as calibrations, checks, or audits are performed on the unit. The operator is encouraged to make copies of this sample sheet to use as needed. HORIBA can also supply the original document in a Microsoft Word® format to be modified as needed. Keeping records of calibrations and maintenance is critical for any monitoring program. Most agencies develop their own SOP for maintenance items and test records.

## **7.5 Self-Test Feature**

A primary method of identifying a hardware malfunction in the APDA-371 is the SELF TEST feature in the TAPE menu. This can identify a large number of the possible mechanical failures in the unit, and is a good place to start if a problem is suspected or if frequent errors are recorded. See Section 3.5 for a description of the self-test process.

## 7.6 Power-Up Problems and Electrical Safety Considerations

The APDA-371 must be at a state where it can be powered on before any other testing or diagnosis can be performed:

- Make sure that the APDA-371 is plugged into the correct AC voltage. The APDA-371 is internally wired for either 110/120V or 220/240V. The digital, analog, and user interface systems are powered from a universal-input power supply, so these should work even if the line voltage is not correct. The filter tape, nozzle, and span check control motors all run on AC voltage and will not operate correctly if the line voltage is incorrect.
- Check the two fuses (3.15A, 250V) inside the power switch housing. The power cord **MUST** be removed before the fuse door can be opened, or you will break it. Pry open the top edge of the power switch housing cover to access the fuses. See Section 2.6.
- It is possible for the display contrast to be set so lightly that it looks like the display is OFF when it is really ON. Try pressing and holding the contrast key on the front door for a few seconds while the APDA-371 scrolls through the contrast settings. In rare cases the display may fail completely. If the APDA-371 “beeps” when you press the keys, it is ON.
- If the above checks do not resolve the power-up problem, then there could be a failed power supply or other significant problem inside the APDA-371. Contact HORIBA for further instructions. Do not attempt to open or repair the power supply assembly unless qualified.

 **CAUTION!** *The APDA-371 uses hazardous live voltages which can cause electrocution if electrical safety precautions are not strictly followed during service or repair of the machine. The APDA-371 is designed to provide protection from hazardous voltages during normal operation. If the equipment is modified or used in a manner not specified by the manufacturer, protection provided by the equipment may be impaired.*

Hazardous voltages are present in the following areas:

- **Power Supply AC:** The main power supply is located inside the APDA-371, inside the power supply sub-enclosure labeled “DANGER HIGH VOLTAGE”. The power supply enclosure contains the main AC-to-DC converter and the motor driver board for the transport motors, all of which contain live AC line voltage when the APDA-371 is powered up. Do not open the power supply sub-enclosure lid without unplugging the APDA-371 power cord.
- **Detector Negative High Voltage DC:** The 3150 circuit board is inside the APDA-371, mounted vertically on the outside of the power supply sub-enclosure, and covered with a clear plastic safety shield. This circuit board generates a dangerous negative DC bias voltage for the beta detector of between -800 and -1200 volts. Do not remove the clear cover or touch the board without unplugging the APDA-371. Do not touch the large green capacitor or the detector preamp board with the APDA-371 turned on.
- **Pump AC:** The vacuum pump is powered by AC line voltage, and has its own power cord. Do not open the electrical junction box on the side of the pump, or touch the enclosed solid-state relay without first unplugging the pump power cord.
- **Inlet Heater AC:** The inlet heater is powered by AC line voltage. The heater either plugs into an external gray plastic relay enclosure on the back of the APDA-371 (with its own power cord), or it plugs directly into the back of the APDA-371 and takes power from the main power supply, with the relay located under a clear plastic cover on the inside floor of the APDA-371 enclosure. See Section 2.5. Do not open the relay cover or touch the relay while the APDA-371 and/or the relay box is plugged in. Do not remove the cylindrical metal shell from the smart heater module, or touch any of the internal parts while the heater is plugged in. The heater module does not contain any serviceable parts inside the metal shell.

## 7.7 Basic Problem and Cause/Solution Table

The following table contains information on some of the more common APDA-371 problems which may be encountered, and some steps to identify and remedy the problems. HORIBA welcomes customer suggestions for new items to include in this section of future manual revisions! If the solution cannot be found in the following table, then contact one of our expert service technicians for help in resolving your problem.

|                        |   |
|------------------------|---|
| <b>Problem:</b>        | <b>The APDA won't start a measurement cycle.</b>  |
| <b>Cause/Solution:</b> | <ul style="list-style-type: none"> <li>• The APDA-371 is programmed not to start a sample cycle until the beginning of an hour. Make sure the clock is set correctly.</li> <li>• The APDA-371 will wait until the beginning of a new hour before it starts, even if the operation mode is set to ON.</li> <li>• Don't expect the pump to turn on until the clean tape count is finished, about 8 minutes after the start of the hour.</li> <li>• The APDA-371 cannot start if the pinch rollers are latched UP! The APDA-371 cannot lower them.</li> <li>• Make sure the filter tape is installed correctly.</li> <li>• The APDA-371 will never start a cycle if the display is left in a TEST or SETUP menu! The main screen or OPERATE menu must be displayed.</li> <li>• The APDA-371 will usually display an error if it cannot start a new sample cycle.</li> </ul>  |
| <b>Problem:</b>        | <b>The analog output voltage and/or digital concentration reading are full-scale.</b>   |
| <b>Cause/Solution:</b> | <ul style="list-style-type: none"> <li>• The APDA-371 will force the analog and digital concentration values to full-scale (usually 0.985mg) to indicate that an error has prevented the collection of a valid hourly data point, or that the hourly cycle was interrupted. Download the digital error log to identify the cause. The current hourly record after power-up will also be full-scale.</li> </ul>  |
| <b>Problem:</b>        | <b>The APDA hourly concentration is reading negative values.</b>  |
| <b>Cause/Solution:</b> | <ul style="list-style-type: none"> <li>• It is possible for the APDA-371 to occasionally read negative numbers if the actual ambient particulate concentration is below the detection limit of the APDA-371, such as below 3 micrograms. This is because the APDA has a noise band of several micrograms. This should not happen often.</li> <li>• If the APDA-371 is reading negative numbers hour after hour, it may be punching holes in the filter tape. These holes can be very small. This is almost always caused by debris on the nozzle or vane. Clean the parts.</li> <li>• The BKGD zero correction offset value may have been incorrectly entered, or may need to be audited. HORIBA supplies the BX-302 zero filter kit for auditing the zero average and noise floor of the APDA-371. Set the BKGD value to 0.000 during the test.</li> <li>• Look for sources of electrical noise, such as bad grounding. Any source of noise will show up in the zero filter test.</li> <li>• Verify that the inlet tube is grounded to the chassis of the APDA-371.</li> </ul> |



|                        |  |
|------------------------|--|
| <b>Problem:</b>        | <b>The airflow rate is too low and won't adjust up to 16.7 lpm.</b>  |
| <b>Cause/Solution:</b> | <ul style="list-style-type: none"> <li>• The gray plastic pump mufflers on the Medo pumps may clog up after several months. Replace it or drill a hole in the end of it for a temporary fix. The brass mufflers on Gast pumps can often be cleaned.</li> <li>• Some users replace the pump muffler with a 30 inch length of air tubing. This will not clog and reduces the pump noise as well as the mufflers do.</li> <li>• The vacuum pump may need to be rebuilt after about 2 years. Medo pumps slowly lose flow capacity as the pump wears out. Eventually, the flow capacity drops below 16.70 lpm when it needs to be rebuilt.</li> <li>• Checking the 18.4 L/min point during the regular 3-point flow audits verifies the pump capacity.</li> <li>• Check the inlet and PM heads for obstructions.</li> </ul> |

|                        |   |
|------------------------|---|
| <b>Problem:</b>        | <b>The airflow is stuck at a particular rate, and will not change.</b>  |
| <b>Cause/Solution:</b> | <ul style="list-style-type: none"> <li>• The flow controller unit on some older units can become stuck. If your flow controller does not have a small circuit board mounted directly on the motor, it needs to be upgraded. Contact the Service dept.</li> <li>• Perform the 3-point flow audit in the TEST &gt; FLOW screen. The APDA should try to regulate to these flow values. If the flow does not change, the flow controller may not be working.</li> <li>• Unplug the pump power while performing a 3-point flow check. With the pump off, you should be able to clearly hear the flow controller pulse at 1-second intervals as it rotates and attempts to regulate the flow. If not, the flow controller is not working or the circuit board output is not working.</li> <li>• If the flow regulates lower, but not higher than 16.70 lpm, the pump is probably worn out, or there is a leak.</li> </ul> |

|                        |   |
|------------------------|---|
| <b>Problem:</b>        | <b>The nozzle gets stuck in the UP position, or won't press down onto the tape fully.</b>   |
| <b>Cause/Solution:</b> | <ul style="list-style-type: none"> <li>• With the nozzle in the down position, lift the nozzle up and down with your thumb and determine if it feels sticky or gritty.</li> <li>• The nozzle O-ring eventually breaks down and needs to be replaced. See Section 7.8 for instructions.</li> <li>• The brass nozzle bushings may have grit in them. See Section 7.8. Remove the nozzle and clean the parts. A shim kit is required for nozzle reassembly.</li> <li>• A stuck nozzle is sometimes caused by a misaligned inlet tube. Make sure it is straight up and perpendicular to the top of the APDA-371.</li> </ul> |

|                        |  |
|------------------------|--|
| <b>Problem:</b>        | <b>The unit has flow leaks, even after cleaning the nozzle and vane.</b>   |
| <b>Cause/Solution:</b> | <ul style="list-style-type: none"> <li>• The nozzle may be sticking as described above. Verify that the nozzle up/down motion is smooth and complete. If the nozzle feels sticky or gritty, it will not seal properly.</li> <li>• Check the O-rings on the sharp-cut cyclone (if used). These frequently leak.</li> <li>• Check the zero of the flow sensor in the APDA-371: Perform another leak check, but disconnect the tubing between the pump and the APDA-371, so there can be no air flow through the APDA-371. Verify that the flow reading on the APDA-371 reads less than 0.2 L/min. If not, the flow sensor <math>Q_0</math> zero offset setting may need to be adjusted in the SETUP &gt; CALIBRATE menu. The <math>Q_0</math> setting is usually very close to zero.</li> <li>• Check for bad O-rings on the APDA-371 inlet tube receiver.</li> <li>• Remove the APDA-371 case cover and inspect all air fittings inside the APDA-371. These are compression fittings, and must be fully inserted to prevent leaks.</li> <li>• Inspect the internal and external flow system for split or cracked air tubing.</li> </ul> |

|                        |   |
|------------------------|---|
| <b>Problem:</b>        | <b>The unit over-measures or under-measures concentrations compared to a collocated FRM filter sampler.</b>   |
| <b>Cause/Solution:</b> | <ul style="list-style-type: none"> <li>• The most common cause is moisture getting on the filter tape or being absorbed by the particulate. Review the Smart Heater settings for proper operation.</li> <li>• Test the filter RH sensor calibration, and log the filter RH on channel 4 if possible. RH should be controlled to 35%.</li> <li>• Verify the flow rate and temperature and pressure calibrations.</li> <li>• Make sure that the K-factor setting has not been changed on the APDA. This would appear as a slope error in the APDA concentration data.</li> <li>• Verify the BKGD (background) value is correct, and perform a 72-hour BX-302 zero filter test to verify. If the BKGD value is not correct, it will offset the APDA data by up to several micrograms.</li> <li>• Check for leaks at the nozzle. A leak can cause either a positive or a negative measurement bias depending if the air leaking around the nozzle is cleaner or dirtier than ambient air.</li> <li>• Verify the collocation setup requirements, especially making sure the inlets are spaced correctly and the same height.</li> <li>• If the analog output of the APDA is being logged by an external datalogger, make SURE the logger's scaling of the APDA output is correct! In most cases, a 0.000 volt <u>analog output</u> on the APDA does NOT equal 0.000mg, but rather -0.015 or -0.005mg. See Section 6.2 and Section 8. Periodically verify that the digital data log from the APDA matches the external logger data.</li> <li>• Single event FRM samplers often perform better than multi-channel FRM samplers. If a multi-channel unit is used, then filter collection must still be performed on a daily basis. If the FRM filters are not properly collected and retained every day, then correlation results with the APDA can suffer.</li> <li>• The daily 24-hour average of the APDA hourly values is calculated externally from the APDA. It is important that the 24 hours worth of APDA data used for correlation to the FRM is the same 24 hour period in which the sampler schedule is run. For example, if the FRM is scheduled to stop for filter changes at 9:00 am each day, but APDA data used for that same day is from midnight to midnight, then a bias can result.</li> </ul> |

|                        |   |
|------------------------|---|
| <b>Problem:</b>        | <b>The unit logs frequent "L" Power Failure errors.</b>   |
| <b>Cause/Solution:</b> | <ul style="list-style-type: none"> <li>• The 5 volt DC power supply output must be set to 5.25 volts. Contact the Service dept for instructions to check or adjust this.</li> <li>• The CHASSIS terminal needs to be connected to a good earth ground.</li> <li>• Try plugging the APDA-371 into a computer-style UPS.</li> <li>• Even a split second power failure will cause an "L" error. This will interrupt the sample cycle until the top of the next hour.</li> <li>• Local high power RF fields must be avoided if possible.</li> <li>• Some vintages of the DC power supply used in the APDA-371 can be prone to oxidization on the harness pins which can cause the APDA-371 to reset frequently. Upgrade parts may be available for certain units. Current power supplies have the output harness wires soldered to the supply. Contact the Service department.</li> <li>• Rarely, some older 220 volt units can experience resets caused by the Smart Heater control wiring inside the APDA-371. Contact the Service department.</li> </ul> |

|                        |  |
|------------------------|--|
| <b>Problem:</b>        | <b>The APDA data shows repeated concentration values hour after hour.</b>  |
| <b>Cause/Solution:</b> | <ul style="list-style-type: none"> <li>• Certain error flags, such as the "T" (tape broken) flag will cause the APDA-371 to repeat the last known good concentration value until the error is resolved. Check the error log to identify any errors for those hours. This only occurs on firmware before R3.6.</li> <li>• If the RANGE setting on the APDA-371 is set higher than 2.000mg, then the resolution of the A/D system is reduced to 2 micrograms. If the ambient air concentrations do not vary much over several hours, then the APDA-371 data may show repeated values due to lost resolution. Leave the RANGE set to 1.000mg unless very high concentrations are expected.</li> </ul> |

|                 |  |
|-----------------|--|
| <b>Problem:</b> | <b>Frequent "D" membrane density errors.</b> |
|-----------------|--|

|                        |  |
|------------------------|--|
| <b>Cause/Solution:</b> | <ul style="list-style-type: none"> <li>• This usually indicates the membrane foil surface is dirty or damaged. It can be cleaned with water rinse. Damaged membranes must be replaced.</li> <li>• The membrane assembly may not be fully extending or retracting properly, which causes the metal part of the assembly to partially or completely block the beta particles. Check the membrane motion.</li> <li>• Verify that the ABS expected membrane mass matches the calibration certificate.</li> </ul> |
| <b>Problem:</b>        | <b>The clock settings are lost when the unit is powered down.</b>  |
| <b>Cause/Solution:</b> | <ul style="list-style-type: none"> <li>• It is normal for the clock to drift as much as 1 minute per month.</li> <li>• The BR2032 lithium battery on the 3230 circuit board may need to be replaced every 1-2 years</li> </ul>   |
| <b>Problem:</b>        | <b>The filter tape keeps breaking during normal operation.</b>   |
| <b>Cause/Solution:</b> | <ul style="list-style-type: none"> <li>• The photo sensors which watch the tape transport motion may be out of alignment. Check the photo sensors as described by section 7.18.</li> <li>• This is sometimes caused by misalignment of the "SHUTTLE" photo sensor or the interrupter flag on the end of shuttle beam inside the APDA.</li> </ul>   |
| <b>Problem:</b>        | <b>The display shows "MISSING TEMP PROBE" message.</b>   |
| <b>Cause/Solution:</b> | <ul style="list-style-type: none"> <li>• The APDA-371 1020 requires a BX-596 or BX-592 ambient temperature sensor if either the CONC TYPE or FLOW TYPE are set to ACTUAL. If no sensor is attached to channel 6 of the APDA-371, this message will appear.</li> <li>• If the Auto ID line from the temperature sensor is not working, the APDA-371 will not ID the sensor, causing the alarm.</li> <li>• APDA-371 1020 units with firmware part 3236-2 (PM10 only) cannot identify the BX-596</li> </ul>     |

## 7.8 Nozzle Component Replacement

The APDA-371 sample nozzle system needs periodic inspection and service in order to prevent flow leaks. The primary indicator is if the nozzle up/down motion feels sticky or gritty when performing the normal monthly nozzle cleaning, or if the nozzle fails to fully seal against the tape when lowered, causing leakage. The nozzle O-ring may need to be replaced approximately every two years during continuous operation. This is a simple matter and no special tools are required. Instructions for O-ring replacement are below.

The sample nozzle may also be easily removed from the APDA-371 for further cleaning or rebuild. This requires a set of brass adjustment shims to set the spring tension during reassembly. The standard BX-308 APDA-371 tool kit contains all of the required tools and instructions. The BX-310 kit includes the two shims only.

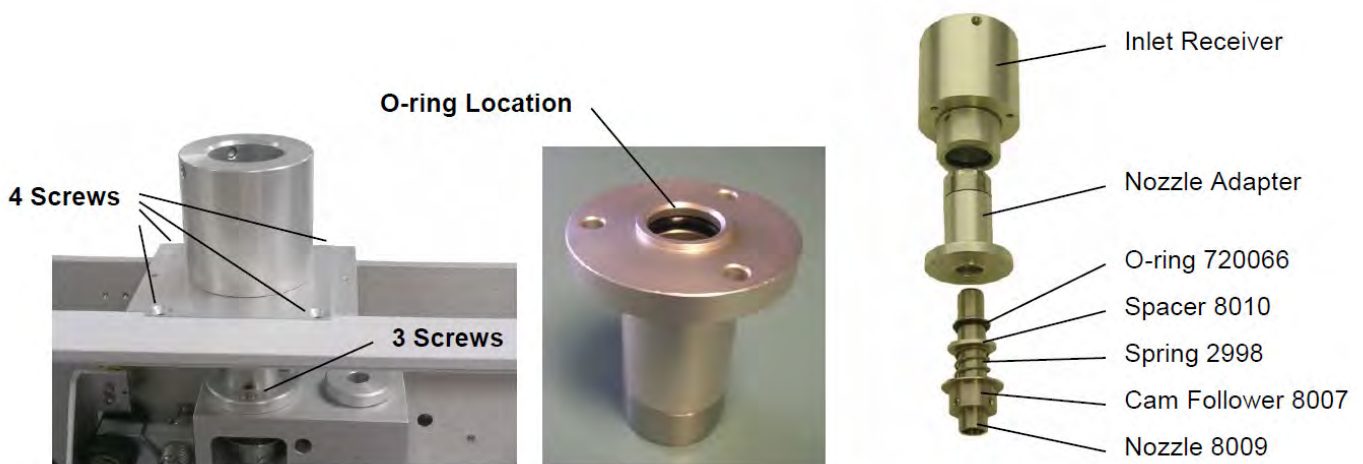

1. Remove the filter tape and the main APDA-371 case cover. The sample nozzle must be in the down position. Lower it using the TEST > PUMP menu if needed. Lift the nozzle up and down against its spring with your thumb and note the action feel.

2. Remove the four screws (two flat head Philips, two 9/64" hex) that fasten the square inlet receiver bracket to the APDA chassis. Lift the assembly off of the APDA. It is not necessary to remove the bracket from the inlet receiver cylinder.
3. Remove the three 9/64" hex screws that fasten the nozzle adapter to the top of the beta block. A T-handle hex wrench is easiest. The nozzle adapter can now be lifted off of the top of the nozzle, revealing the O-ring location. Clean the top of the nozzle.
4. Remove the O-ring from the groove. Thoroughly clean the O-ring groove and the inside of the nozzle adapter using alcohol and cotton-tipped applicators, then install the new O-ring and lubricate it with silicone grease.
5. Check the nozzle up/down action again before reassembly. If the nozzle action feels smooth, then reinstall the nozzle adapter and inlet receiver assemblies. Check the nozzle action after each step of reassembly to identify any binding or sticking. Perform a normal leak check when finished.
6. **Optional further disassembly (shim set required):** If the nozzle action feels sticky or gritty with the nozzle adapter removed, then the nozzle needs to be removed and the nozzle and bushings cleaned. Loosen the two (or three) set screws in the cam follower with a 5/64" hex wrench. The nozzle can now be lifted out of the bushings. The cam follower, spring, and spacer can be removed from the front of the block.
7. Clean the nozzle inside and out, and inspect the nozzle face for any burrs or defects. Clean the two brass bushing bores with a cotton-tipped applicator. This is also a good time to clean and inspect the tape support vane since the nozzle is out of the way. The bushings do not need to be lubricated. Reinstall the cam follower, spring, and spacer, and align them with the bushing bores.
8. Lower the nozzle down through the bore. The two brass shims must be positioned as shown before the set screws are tightened to retain the nozzle. The square shim must be under the nozzle face. The slotted shim goes under the cam follower. Tighten the set screws evenly, only a little at a time to avoid distorting or binding the nozzle.
9. Remove the shims and check the up/down action of the nozzle before reassembling the nozzle adapter and inlet receiver. It must feel smooth and even after each step of reassembly. If the nozzle still binds or sticks, then contact technical service.

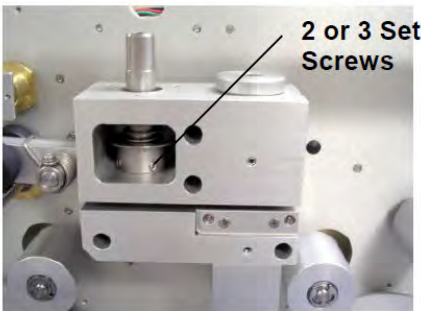

Nozzle Removal

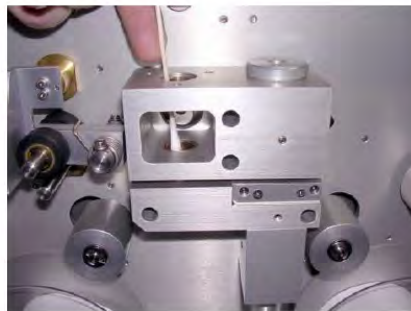

Cleaning the Bushings



Using Shims for Reassembly



## 7.9 Performing the 72-Hour Zero Filter Background Test

All APDA-371 monitors should have a zero-filter test performed before the equipment is first deployed so that an initial BKGD adjustment may be made, if necessary. This test should be repeated periodically as part of a QA/QC program, the frequency of which is up to the user.

When the APDA-371 is set up for the first time, a minimum of 48-72 valid 1-hour zero-test data points should be collected in order to accurately determine the BKGD value. Subsequent, periodic zero tests may be performed with fewer 1-hour values, but this will result in a less accurate BKGD calculation.

The initial zero-test is used to determine the instrument noise ( $\sigma$ ) and to confirm that the lower limit of detection (LLD), which is  $2\sigma$ , is within specifications. For an 8-minute count cycle the LLD is  $<4.8 \mu\text{g}/\text{m}^3$  for a 1-hour measurement cycle and for a 4-minute count cycle the LLD is  $<7 \mu\text{g}/\text{m}^3$ . The initial zero test and all subsequent zero tests should be performed using an 8-minute count cycle if the APDA-371 will be operated with an 8-minute count cycle. The zero tests should be performed with a 4-minute count cycle if the APDA-371 will be operated with a 4-minute count cycle.

The initial zero-filter test should be performed after the APDA-371 is installed at the monitoring site. If this is not feasible, then performing the test with the monitor sitting on a nearby laboratory bench before deployment is acceptable.

If the APDA-371 is to be operated with a “smart heater” (BX-826 or BX-827), the zero-filter test should be performed with the smart-heater engaged, but running in “low power mode” for the duration of the test. Low power mode is activated by setting the FRH CONTROL parameter to NO (see section 6.9).



*Weather (rain, mist, very high humidity, high dew point, etc.) can sometimes make it difficult to perform the zero-filter test with the filter mounted outdoors at the monitoring site. In these situations, the BX-302 zero filter assembly should be mounted inside the shelter. Replace the standard inlet tube, with the short 1.5 foot long inlet tube (this tube is included with each APDA-371 to sample room air). Mount the smart-heater and the BX-302 zero filter assembly on this shorter tube inside the shelter.*

The ambient temperature sensors (BX-592, BX-596, or BX-597) should always be placed in the same environment from which the air is sampled. If the BX-302 is mounted inside the shelter, the ambient temperature sensor should also be placed inside the shelter.

It is recommended that the APDA-371 be operated for at least 24-hours before commencing the zero-filter test. A leak check and flow check should be performed before proceeding on to the following steps for the zero-test. Although it is not necessary to reset the existing BKGD value to 0 for the purpose of conducting the zero-test, doing this will minimize the chance of a miscalculation.

1. Enter the SETUP > CALIBRATE menu.
  - a. Record the existing BKGD value, then change it to 0.0000 (optional).
  - b. Note the Conc type and set it to Actual if it is not.
  - c. Note the Flow type and set it to Actual if it is not.
  - d. Save and exit back to the main menu.
2. Install the BX-302 zero filter assembly onto the top of the inlet tube.



**NOTE:** *When it is necessary, the BX-302 zero filter assembly may be inside the shelter to avoid aspiration of water through the zero filter.*

3. Allow the APDA-371 to sample for 48-72 consecutive hours, not counting the warm-up period for the initial zero-test. For the zero-test to be valid, no errors should be logged either during the warm-up period or during the 48-72-hour sampling period. For subsequent zero tests the user may decide to use fewer valid data points (such as 24 for example).
4. Calculate the average of the hourly APDA-371 concentrations to the nearest 0.1  $\mu\text{g}/\text{m}^3$ .

**The new BKGD value is the negative of this average.**

For example, if the average of the data sample is 0.0021 mg (2.1  $\mu\text{g}$ ), the correct BKGD value is -0.0021. Record the new BKGD value.

**NOTE:** *If the APDA-371 is being deployed for the first time, replace the factory-set BKGD with the new BKGD value. As HORIBA runs the initial factory zero-test without the smart heater engaged, the initial zero-test performed by the end user may differ from this value if the end user used a smart heater during the test.*

5. Calculate the standard deviation of the sample (STDEV on MS Excel) to the closest 0.1  $\mu\text{g}/\text{m}^3$ . Confirm that the LLD of the APDA-371 meets the factory specified value.

**NOTE:** *Older non-FEM compatible units may not meet these noise specifications.*

6. If the results of the zero test indicate that the instrument LLD is higher than the factory specified value or that the BKGD value has changed by more than 2  $\mu\text{g}/\text{m}^3$  since the most recent field (not factory) zero-filter test, repeat the zero-filter test. If the problem persists contact the factory.
7. Enter the new BKGD value into the SETUP > CALIBRATE menu on the APDA-371. Restore the CONC and FLOW type settings to their pre-test configuration, if applicable. Save and exit back to the main menu.

## 7.10 TEST Menu System

The following sub-sections provide information for performing diagnostic checks on the APDA-371 sub-systems using the TEST menus. Most of these tests will be used for troubleshooting purposes only and are not necessary on properly functioning units. The TEST menu system is accessed by the TEST soft-key from the main menu and is shown below. These screens are used to perform calibrations and audits of various sensors, as well as some advanced diagnostics to resolve failures and errors.

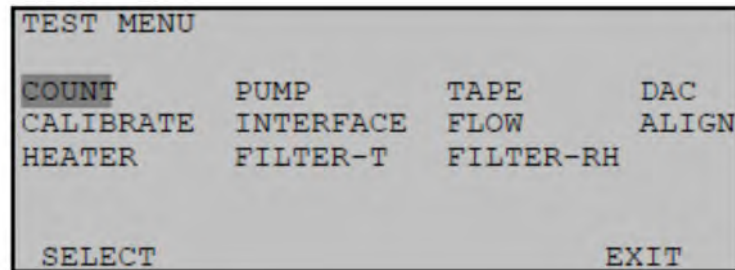

The TEST Menu

## 7.11 COUNT Test Menu

The TEST > COUNT screen allows the user to check the function of the beta detector and beta source separate from the rest of the mechanical or flow operations. Each count test will take 4 minutes, and will show the number of beta particles counted as they accumulate. The final count total will stay on the display after the counting is finished, and up to six count tests can be displayed on the screen at once. Count tests are usually performed with a clean section of filter tape between the source and detector, as in normal operation.

The GO soft key is pressed to start a new four-minute static count test. The COUNT value on the screen will immediately begin to count rapidly if the detector is operational and unobstructed. Typical four-minute count totals through clean filter tape are between 600,000 and 1,100,000 counts. The count total will be lower if the membrane is extended. After four minutes the counting will stop and wait for the operator to initiate another count or EXIT.

The M value on the screen indicates if the membrane was extended (Y) or withdrawn (N) during the count period. The MEMBRN and NO MEMBRN soft keys can be used to manually extend or withdraw the span membrane foil before a count test if desired.

**Dark Count Tests:** A steel shim such as part 7438 can be placed between the beta source and detector to perform a dark count test. The shim blocks all beta particles, and only counts created by noise or cosmic rays will appear. The total four-minute dark count value should be less than 10 counts. If the total is more than 50 counts, contact technical service.

## 7.12 PUMP Test Menu

The TEST > PUMP screen is used to perform leak checks. It can also be used to manually force the pump on and off, or to manually move the nozzle.

**NOTE:** The APDA-371 will regulate the flow to the 16.70 L/min set point, but the flow rate shown on this screen is uncorrected and always in standard conditions, even if the APDA operates in actual flow mode.

**For this reason, no flow audits or checks should be performed using this screen! Obsolete APDA-371 units with a manual flow valve were calibrated using this screen.**

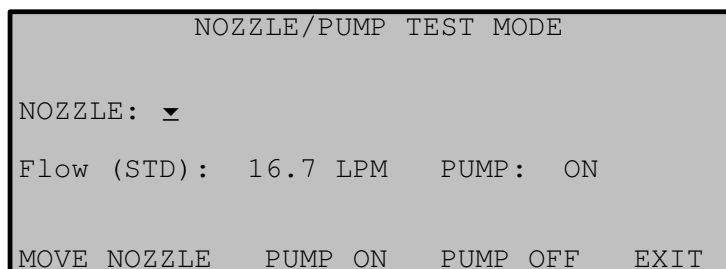

**The PUMP Test screen**

The NOZZLE status value will indicate if the nozzle is currently UP (↑) or DOWN (↓). The PUMP status indicates if the pump is turned ON or OFF. The FLOW value is the current flow rate, displayed in standard liters per minute (25°C) only. The MOVE NOZZLE soft key can be used to force the nozzle up or down for testing purposes. Elapsed time is about 5 seconds. If the pump is ON this operation is disabled.

The PUMP ON and PUMP OFF soft keys can be used to turn the vacuum pump on or off. The nozzle will be lowered automatically if PUMP ON is pressed.

## 7.13 TAPE Test Menu

The TEST > TAPE menu allows the user to manually move the filter tape forwards or backwards in increments of 12.5mm “windows”. This is useful for spooling up the first few turns of a fresh roll of tape, to test the tape transport mechanism, or to change spots of tape for flow or count tests. The nozzle will be automatically raised if necessary, and the tape will take a couple of seconds to move each window.

The “X:” value is the number of windows moved in the last motion. This number will be negative if the last move was backwards.

The FEED value is the number of tape windows you want to move. Use the arrow up/down keys to select up to 10 windows at a time.

The FWD and BKWD soft key move the tape forward or backward by the current amount of the FEED value.



## 7.14 DAC Test Menu – Analog Output Test

The TEST > DAC screen is used to test the function of the analog output voltage and the DAC (digital/analog converter) electronics. Use the up/down arrow keys to force the voltage to any value between 0.000 and 1.000 volts (0.100V increments). The corresponding voltage on the VOLT OUT +/- terminals on the back of the APDA-371 should always match within  $\pm 0.001$  volts. Use a high-quality voltmeter for these tests. If the actual voltage does not match the value on the TEST > DAC screen, contact the service department.

**NOTE:** This function is critical for all users of external analog data loggers. Measure the voltage all of the way to the input of your data logger. Every millivolt of error is a microgram of error! Make sure the logger is scaling the voltage correctly. In most cases 0.000V should scale as -0.015mg, and 1.000V should scale as 0.985mg. See Section 6.2.

## 7.15 CALIBRATE Test Menu

The TEST > CALIBRATE screen is used to perform tests of the reference membrane span check which occurs automatically every sample cycle. This test can be run if the APDA-371 has been logging **D** errors. Each APDA-371 has an individually weighed membrane, and this mass (**m**) is measured and displayed during this test. Compare the value from this test with the ABS value on the calibration sheet for your unit. The values must match within 5%, and will typically match within just a few micrograms. If not, the most common cause is a dirty membrane foil, which can be carefully cleaned with canned air or clean water rinse. Alcohol is not used because it leaves a film. CD cleaner works well for badly soiled membranes.



**CAUTION:** The span membrane foil is a thin sheet of polyester and is fragile.

It must be replaced if damaged. Contact the Service department for replacement instructions.

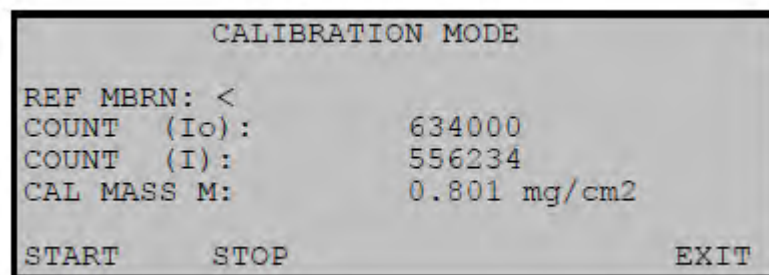

### The CALIBRATE Test Screen

The REF MBRN value indicates if the reference membrane is currently extended (>) or withdrawn (<) from the beta particle path.

The COUNT (I<sub>0</sub>) value is the total 4-minute beta count through the filter tape only.

The COUNT (I) value is the total 4-minute beta count through both the filter and the membrane, and is always less the I<sub>0</sub> count.

The CAL MASS M value is the measured mass of the foil derived from the two count values.

The START soft key starts the test cycle. Counting will immediately begin. After 4-minutes the I<sub>0</sub> count will stop, the membrane will extend, and the I count will begin. At the completion of the test, the counting will stop and the mass of the membrane will be calculated. The total elapsed time is about 8.1 minutes per test.

## 7.16 INTERFACE Test Menu

The TEST > INTERFACE screen is used to test the relay inputs and outputs on the back of the APDA-371. The two inputs TELEM FAULT and EXT RESET are tested by applying the appropriate signal to the terminals on the APDA, then verifying that the value on this screen changes in response.

The relay outputs TAPE FAULT, FLOW FAULT, INVALID DATA, MAINTENANCE, RELAY 1, and RELAY 2 are tested by turning them ON or OFF using the arrow keys, then verifying that the contact closure outputs on the back panel terminals respond accordingly with an Ohm-meter. The old RANGE relay output is no longer supported.

## 7.17 FLOW Test Menu

The TEST > FLOW screen is where the important flow audits, checks, and calibrations are performed on the APDA-371. See sections 5.4 and 5.5. This screen is also useful for checking the ambient temperature and barometric pressure sensors, and for pump capacity and flow controller tests.

## 7.18 ALIGN Test Menu – Photo Sensor Tests

The TEST > ALIGN menu system is used primarily to test the nine photosensors which monitor all of the mechanical movement in the APDA-371 tape transport assembly. This is useful if the APDA-371 has failed some of the Self-Test parameters. The function of the six ALIGN sub-menus are described in this section.

**NOTE:** The filter tape should be removed during these tests, because many of these functions will break the tape.

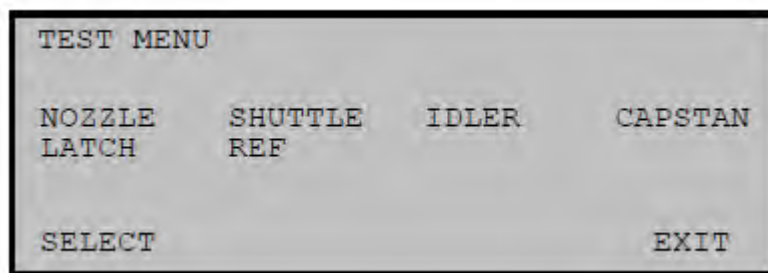

The TEST > ALIGN Menu

### NOZZLE:

This screen tests the two nozzle photosensors and the nozzle motor. Use the UP and DOWN soft-keys to move the nozzle, and monitor the status of the S4 and S5 photo sensors on the screen.

### SHUTTLE:

This screen tests the photosensor which monitors the position of the shuttle beam (the two outer tape rollers that move together). The status of photo sensor S7 should only change to ON when the beam is moved all the way to the right side. The shuttle must be moved by hand for this test. It rides on a ball slide and is not motor-driven.

### IDLER:

This screen tests the photosensors which monitors the position of the right-side spring-loaded tape tensioner. The tensioner must be moved by hand. When the tensioner is in the leftmost position under its spring pressure, both photo sensors S6 and S1 should be OFF. If the tensioner is moved to the middle of its travel, photo sensor S1 should be ON and S6 OFF. When the tensioner is at the rightmost position, S1 and S6 should both be ON. These are the sensors which monitor tape breakage and tape tensioning. The left side tensioner assembly has no photosensors.

**CAPSTAN:**

This screen tests the photosensor which watch the rotation of the Capstan shaft motor. This is the shaft under the rubber pinch rollers which drives the filter tape forwards and backwards. Press the ADVANCE soft-key to rotate the Capstan counter-clockwise, and the BACKUP soft-key to rotate clockwise. The shaft should turn one-half of a rotation each time. Photo sensor S8 should turn ON to stop the shaft at each half-turn, and will be OFF while the shaft is turning. It is helpful to put an ink mark on the end of the shaft to view the rotation.

**LATCH:**

This screen shows the status of the pinch roller latch. If the rollers are latched in the UP position, then S9 should be ON. S9 should turn OFF if the latch is unhooked.

**REF:**

This screen tests the two photo sensors which monitor the position of the reference membrane assembly. When the EXTEND soft-key is pressed the membrane should extend and the S2 photo sensor should be ON, and S3 OFF. When the WITHDRAW soft-key is pressed the membrane should withdraw and the S2 photo sensor should be OFF and S3 ON. It takes a few seconds for the membrane to move.

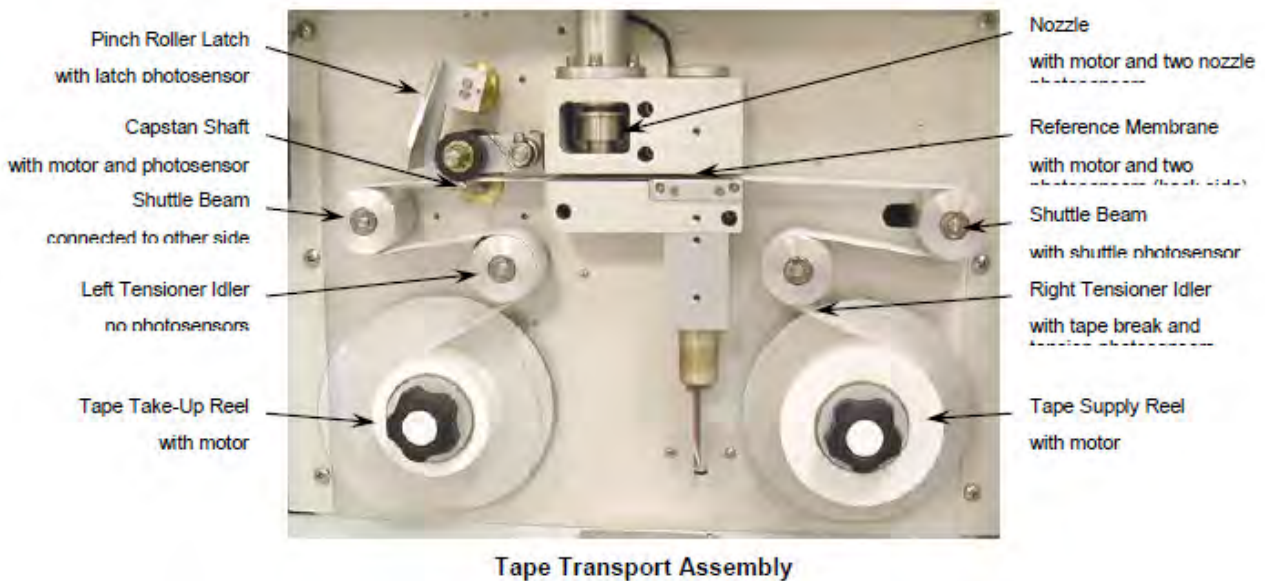

**7.19 HEATER Test Menu**

The TEST > HEATER screen is used to force the Smart Heater ON or OFF for testing purposes. The heater takes several minutes to heat up or cool down noticeably. The heater automatically turns back off upon exit from the screen.

## 7.20 FILTER-T Test Menu – Filter Temperature Sensor Test

The TEST > FILTER-T screen is used to check or calibrate the filter temperature sensor located in the air stream beneath the filter tape. When this screen is entered, the APDA will automatically raise the nozzle and turn the pump on. This allows ambient room air to equilibrate the filter temperature sensor. Allow the pump to run for at least 5 minutes to allow the sensor to equilibrate. When fully equilibrated, the filter temperature should match ambient within +/- 1 deg C. To calibrate it, enter the ambient room temperature from your reference standard into the REFERENCE field and press the CALIBRATE soft key. The RESET soft key can be used to revert to default calibrations and start over if difficulty is encountered.

**NOTE:** Never calibrate this sensor if the APDA inlet heater has been operating recently. The heater causes this sensor to measure higher than ambient. See the notes about equilibrating or removing the filter RH sensor for calibrations below.

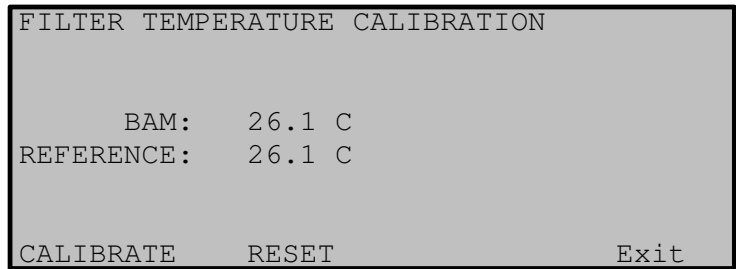

The FILTER-T Test Screen

## 7.21 RH Test Menu – Filter Humidity Sensor and Calibration

The TEST > FILTER-RH screen is used to check or calibrate the filter relative humidity sensor located in the air stream beneath the filter tape. The sensor measures the RH of the sample air to control the Smart Inlet Heater system, which turns up or down as needed to maintain the sample near or below the RH set point value. See Section 6.9. The filter RH sensor (part 9278) should match ambient RH within +/- 4% when properly equilibrated. If the sensor fails, it usually reads something impossible like -25% or 135% RH.

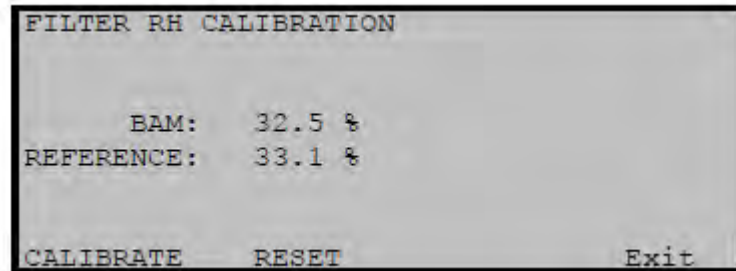

The FILTER-RH Test Screen

## Important Equilibration Notes:

It is difficult to effectively correlate an ambient RH measurement to the filter RH reading, because the APDA-371 has some self-heating from the Smart Heater which causes the filter sensor to measure significantly lower than ambient RH. For this reason it is usually best to leave the factory default calibration alone, unless you have clear evidence that it needs to be calibrated.



**CAUTION:** *If the filter RH sensor is calibrated without first being fully equilibrated to ambient, it will introduce a large artificial offset.*

For example: The ambient RH is 50%, but the filter RH sensor reads 20% due to inlet heat. If the filter sensor calibration is adjusted to that it matches 50%, this adds a +30% offset to all RH readings. Now the filter RH data values are all 30% too high and it looks like the inlet heater is not functioning and not regulating the sample RH when it actually is. In addition, the inlet heater may run at full power trying to achieve regulation to the set point.

### To equilibrate the sensor without removing it from the sample stream:

Enter the TEST > FILTER RH screen. The APDA-371 will raise the nozzle and turn the pump on to pull room air past the RH sensor. Unplug the inlet heater and allow the APDA-371 to cool completely to room conditions. This might take an hour or more. Position your RH audit device as close as possible to the APDA-371 sample nozzle during calibration.

### To remove the sensor from the flow system for calibration:

Unplug the inlet heater and remove the APDA-371 case cover. Remove the black 3-port compression manifold from the flow path. It is located under the nozzle motor and holds the two filter sensors. This is easiest with tool 9627 from the BX-308 tool kit. Leave the sensors plugged into the circuit board. Do not touch the RH sensor element because it is ESD sensitive. Move the sensor manifold away from the APDA-371 so that an accurate ambient RH value can be obtained. Enter the TEST > FILTER-RH menu and allow the sensor to equilibrate for at least five minutes, then compare the APDA-371 RH reading on the display to your reference RH device. To calibrate the sensor, enter the reference value into the APDA-371 display and press CAL to change the APDA-371 value to match.



**The RESET key can be used to remove all previous field calibrations from the sensor and restore the default factory calibration.**

Do not press the CAL key after RESET, or whatever value happens to be in the REFERENCE field will be calibrated.

## 8 EXTERNAL DATALOGGER INTERFACE SYSTEM

This section describes the configuration of the APDA-371 to work with a separate, external data logger. The APDA-371 provides an analog concentration output voltage along with a clock synchronization input feature which allows unit to function with many analog data loggers. The APDA-371 digital data outputs can also be collected with digital data loggers or automatic digital data acquisition systems. In any case, the APDA-371 internal digital data logging system still stores the complete data array, which can be collected periodically.

This section describes the APDA-371 configurations required for external data loggers. Consult your data logger documentation for the specific setup requirements for your model.

### 8.1 Analog Concentration Output Signal

The APDA-371 analog output type is selectable between voltage output (0-1 or 0-10 volt DC) or isolated current output (4-20 or 0-16 mA). The rear panel dipswitches are used to select the desired output as shown in the table below. The 1-volt voltage output is almost exclusively used for analog data logging applications

| SWITCH | ON       | OFF      |
|--------|----------|----------|
| SW1    | 0-10 vdc | 0-1 vdc  |
| SW2    | 4-20mA   | 0-16mA   |
| SW3    | Not used | Not used |
| SW4    | Not used | Not used |

**IMPORTANT NOTE:** *The scale of the output voltage of the APDA-371 is determined by the RANGE and OFFSET setting. See Section 6.2.*

In most applications where the OFFSET is set to -0.015, and the RANGE is set to 1.000 mg, the APDA-371 analog output will be scaled as

**0.000v to 1.000v equals -0.015 mg to 0.985 mg.**

It is critical that your analog data logger input is programmed to scale this voltage correctly, or a significant data offset mistake will occur! The APDA-371 digital data should be periodically compared to the analog logger data to ensure correct logger scaling. In addition, the APDA-371 output voltage DAC should be tested as described in Section 7.12 to ensure that the actual voltage output of the APDA-371 matches the expected voltage.

**Analog Error Encoding:** The analog output is the only voltage channel available between the APDA-371 and the data logger, so any errors generated by the APDA-371 are reported using the same voltage signal. The APDA-371 will set the analog output to its full-scale reading whenever a critical error prevents a valid concentration from being measured. It can optionally set the voltage to full-scale in response to other non-critical alarms as described in section 6.5. The external data logger should be programmed to recognize a full-scale reading as an error, and not a valid concentration. This method is used because it is rare for an actual concentration reading to exceed the range of the APDA-371, and if it does, it should be reported as an invalid data point anyway. The digital data values stored in the APDA-371 are always unaffected and available, if the alarm was non-critical and did not prevent the hourly concentration measurement from occurring.

## 8.2 Early Cycle Mode Description

During a standard APDA-371 measurement cycle, the APDA-371 waits for the beginning of the new hour before it sets the analog output to represent the just-finished hour's concentration. However, some types of data loggers must have the concentration value available **before** the new hour starts, or the data will be stored in the wrong hour.

The APDA-371 has a special EARLY cycle mode (in the SETUP > INTERFACE menu) which causes the APDA-371 to start and finish the measurement a few minutes early in order to output the concentration voltage for the last five minutes of the hour which was just sampled. The data logger must be programmed to read this value during the window. Because of the critical timing involved, the APDA-371 clock will have to be synchronized to the data logger clock using the EXT RESET inputs described below. The following describes the timing of the STANDARD and EARLY modes.

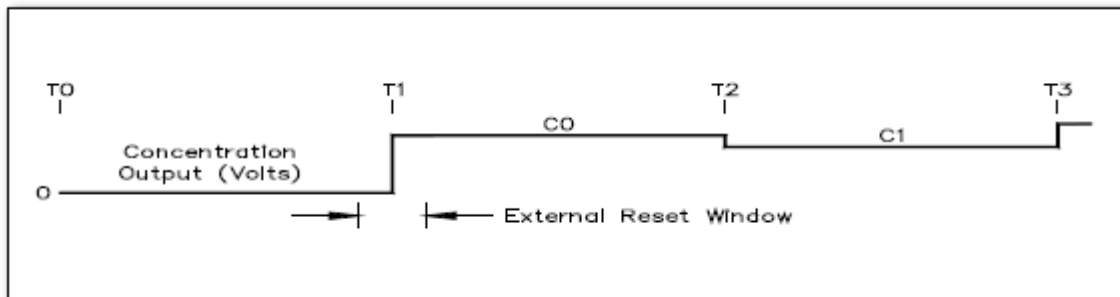

STANDARD Cycle Example

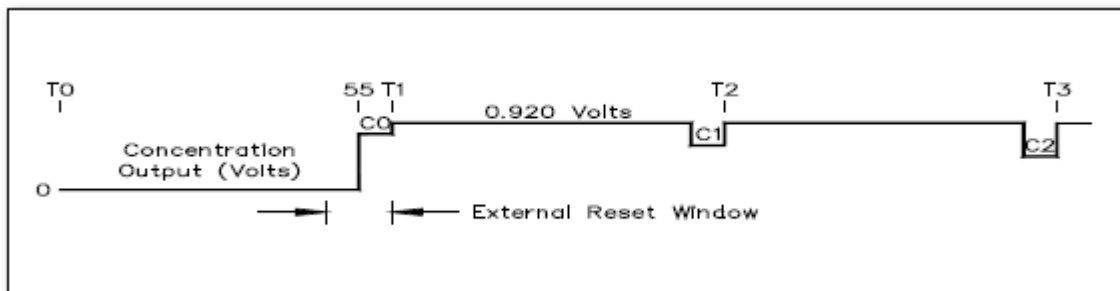

EARLY Cycle Example

### Analog Output Levels:

$C_0$  represents the concentration output level measured from time  $T_0$  to  $T_1$ , where the T labels represent the top (beginning) of an hour (such as 12:00:00). As you can see, the concentration voltage  $C_0$  for the standard cycle is present for the whole next hour following the measurement. In early mode the  $C_0$  voltage for the current hour is present for only the last 5 minutes of the hour just-sampled (minute 55 to 60), and all other times the concentration output voltage is 0.920 volts.

### External Reset Windows:

An external reset signal may be used to synchronize the APDA-371 clock to the data logger. In standard mode the external reset window is plus or minus 5 minutes around the beginning of the hour, but in early mode the external reset window is between minute 50 and 60 only. The APDA clock will not reset if the previous cycle has not finished the I3 count, and an "E" alarm will be logged. See Section 7.2.

### Standard Mode Clock Resets:

- Minute 0 to 5: An external reset signal will change the APDA-371 clock back to the 00:00 of the current hour. If a cycle has already started, it will continue. No error occurs since there is adequate time to complete the cycle.
- Minute 5 to 55: An external reset signal has no effect. The error log will contain the date and time of the “E” alarm reset attempt.
- Minute 55 to 60: If an external reset occurs after a completed cycle (idle condition), then no error occurs. The clock will be set forward to 00:00 of the next hour and a new measurement cycle will start.

### EARLY Mode Clock Resets:

- Minute 55 to 60: The external reset signal changes the clock back to minute 55:00 of the current hour. A new measurement cycle will start at that moment. If a cycle has already started, it will continue. No error occurs since there is adequate time to complete the cycle.
- Minute 0 to 50: The external reset signal has no effect. The error log will contain the date and time of the “E” alarm reset attempt.
- Minute 50 to 55: If an external reset occurs after a completed cycle (idle condition), then no error occurs. The clock will be set forward to minute 55:00 of the current hour and a new measurement cycle will start.

## 8.3 Telemetry and Error Relays

In addition to the analog output voltage, several input and output relay connections are provided on rear panel of the APDA-371. These can be connected to an external data logger as a second method of indicating alarms between the APDA and the logger, but in practice most of these relay telemetry connections are rarely used. The function of each input and output is described below.

**NOTE:** A **contact-closure input** to the APDA-371 is achieved by shorting the two terminals on that particular input together, usually with a relay on the external data logger. The data logger should not apply any voltage to the terminals.

**Contact-closure outputs** from the APDA-371 are provided by the APDA-371 shorting the two terminals together with an internal relay, without applying any voltage or current to them. The external data logger must then sense the closure. The contacts are rated at 100VDC, 0.5A max.

**Normally-Open** means that the relay contacts are not shorted together unless a certain condition occurs.

**Normally-Closed** means that the relay contacts are shorted until the condition occurs, then they open.



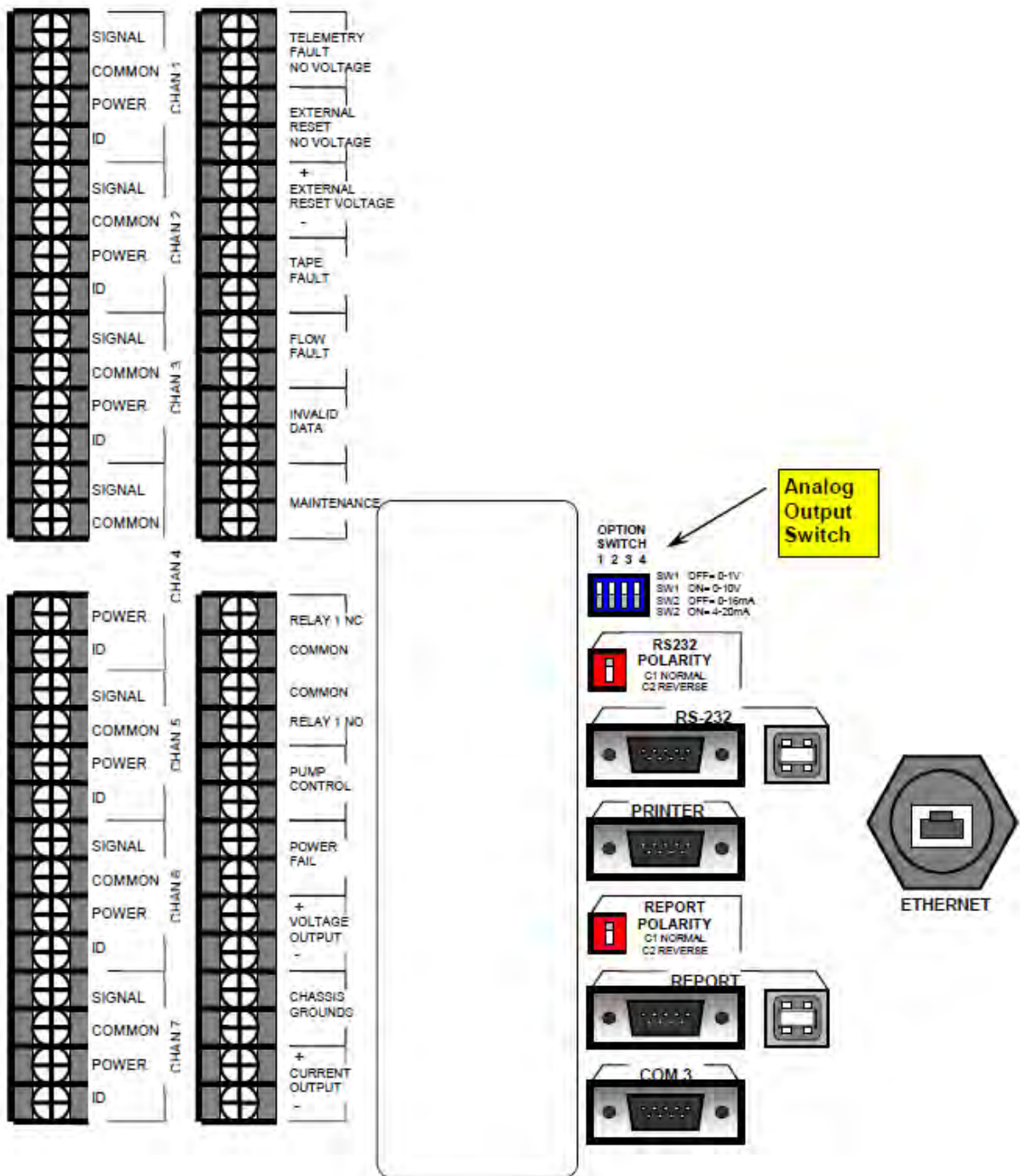

**APDA-371 Back Panel Relay Connections (Extra Report Processor Digital Outputs Shown)**

## **1. TELEMETRY FAULT NO VOLTAGE**

This input can be used to signal the APDA-371 that the external telemetry system (data logger) is not operational. This contact-closure input must be activated for a minimum of 2-seconds. If activated, the APDA-371 will continue to function and will log a "U" error (see section 7.2), and will also activate the INVALID DATA relay output. This input can be set to normally-open or normally-closed in the SETUP > INTERFACE menu. Rarely used.

## **2. EXTERNAL RESET NO VOLTAGE**

This input can be used to synchronize the APDA-371 clock to the external data logger at the top of the hour, and is often used in EARLY cycle mode. This is a contact-closure input which must be activated for a minimum of 2-seconds. The input can be set to normally-open or normally-closed in the SETUP > INTERFACE menu.

## **3. EXTERNAL RESET VOLTAGE**

This input is the same as above except the input is activated by a TTL logic voltage level instead of a contact-closure. Max 15mA @ 15V or 5mA @ 5V DC. Five-volt logic is typically used for this input.

## **4. TAPE FAULT`**

This is a contact-closure output which will be activated whenever a "T" tape error is generated by the APDA-371 (see section 7.2). Polarity is normally-open.

## **5. FLOW FAULT**

This is a contact-closure output which will be activated whenever an "F" flow error is generated by the APDA-371 (see section 7.2). Polarity is normally-open.

## **6. INVALID DATA**

This is a contact-closure output which will be activated whenever a C, P, N, R, L, I, M, or U error is generated by the APDA-371 (see section 7.2). Polarity is normally-open.

## **7. MAINTENANCE**

This is a contact-closure output which will be activated whenever a maintenance "M" flag is generated by the APDA-371 (see section 7.2). Polarity is normally-open.

## **8. RELAY 1 NC/NO**

This relay output is used in dual-unit coarse configurations only. The master APDA-371 outputs a clock synch signal to the external reset input of the slave unit using this output.

## **9. PUMP CONTROL**

This is the low-voltage output which signals the vacuum pump to turn on or off. There is no polarity on this output because the pump controller has a diode bridge input. Connect the two-wire control cable from the pump to these output terminals.

## **10. POWER FAIL**

This is a contact-closure output which will be activated (closed) whenever a power failure or an "L" error occurs in the APDA-371 (see section 7.2).

## **11. VOLTAGE OUTPUT**

This is the APDA-371 analog concentration output voltage connection. See section 8.1. Polarity must be observed on this output.

## **12. CHASSIS GROUNDS**

These are the earth-ground terminals. These should be attached to a ground rod for best operation of the APDA-371.

## **13. CURRENT OUTPUT**

This is used when the analog output is needed in current loop form instead of voltage. Typically only used if there is a long distance between the APDA-371 and the data logger. Output is selectable between 4-20mA or 0-16mA.

## 8.4 Digital Datalogger Interfacing with the APDA-371

Many APDA-371 users configure an external digital data logger to retrieve data from the APDA-371. This typically requires some programming experience with the particular type of digital logger to be used. Several environmental data logger manufacturers supply pre-made APDA-371 drivers for basic data collection applications. All digital files from the APDA-371 must be obtained through the RS-232 port or the newer REPORT serial port, or in some cases from the PRINTER port. The APDA-371 digital files are described in Section 9.

The most common method is to program the digital logger to request the last hourly comma-separated data record array from the APDA-371, once per hour, using the RS-232 or REPORT port. In this case, the logger must establish connection with the APDA-371 by sending three carriage returns (ENTER key), then send the **6 (csv report), 4 (last data)** command string just like you might when downloading the data with a computer and a terminal program as described in Section 9.4. The logger must ignore the APDA-371 menu responses, then receive the hourly data array response and parse out the desired data parameters and store them appropriately. The last concentration value, Qtot flow volume, ambient temperature, pressure, filter RH, and alarm bits are often collected in this manner.

**CPU Interruptions:** Care is required when collecting data from the classic APDA-371 RS-232 port. The APDA-371 main CPU cannot multitask, so if the APDA-371 is moving any of the filter tape or span membrane motors (especially near the top of each hour) it will ignore any RS-232 serial port commands and interrupt any serial data downloads until the mechanical motion is complete. See Section 4. The best solution when using the classic RS-232 port is to program the digital logger to make a single hourly data request to the APDA-371 near the middle of each hour, such as between minute 25 and minute 50. However, small files such as the last hourly record can be downloaded very quickly, and may be accomplished at almost any time during the hour as long as the timing is carefully controlled. If your data logger is programmed to digitally request data from the APDA-371 RS-232 port continuously throughout the hour (such as every minute), then some number of the data requests will certainly be ignored by the APDA-371 due to mechanical interrupts.

The BX-965 Report Processor back panel option was designed to allow easier digital data connectivity with the APDA-371. The REPORT serial port works exactly like the classic RS-232 port and accesses the same files, except that it has its own CPU and memory and cannot be interrupted or ignored. The REPORT port also has much more data memory capacity. The classic RS-232 port and its legacy functionality is also still supported on Report Processor back panels as a backup.

**Clock Timing With Digital Loggers:** Timing must also be considered when collection APDA-371 data with a digital system. If the APDA-371 is operating in standard cycle mode, then the digital concentration data values are updated exactly at the top of the hour. If the digital logger is set to collect the APDA-371 concentration value as soon as it is available, then the clocks should be synchronized to prevent collecting the wrong hourly record.

If the logger must have the APDA-371 concentration before the top of the hour, then the APDA-371 can be set for early cycle mode, and the APDA-371 clock will have to be synchronized to the logger. Some APDA-371 users leave the APDA-371 in standard cycle mode and set their digital logger to synchronize the APDA-371 clock at minute 59 of the hour. This causes the APDA-371 to be one minute ahead of the logger so that the concentration is available at the top of the logger hour. This method is similar to running in early cycle mode, except the timing schedule is much easier to understand.

## 9 RS-232 SERIAL COMMUNICATIONS – DATA RETRIEVAL



This section describes the methods used to retrieve digital data files through the RS-232 serial communications system on the APDA-371. The APDA-371 has one or more two-way RS-232 serial ports which may be used with a computer, laptop, modem, or digital data logger. The data can be accessed through the serial ports with a terminal program and a simple menu driven interface.

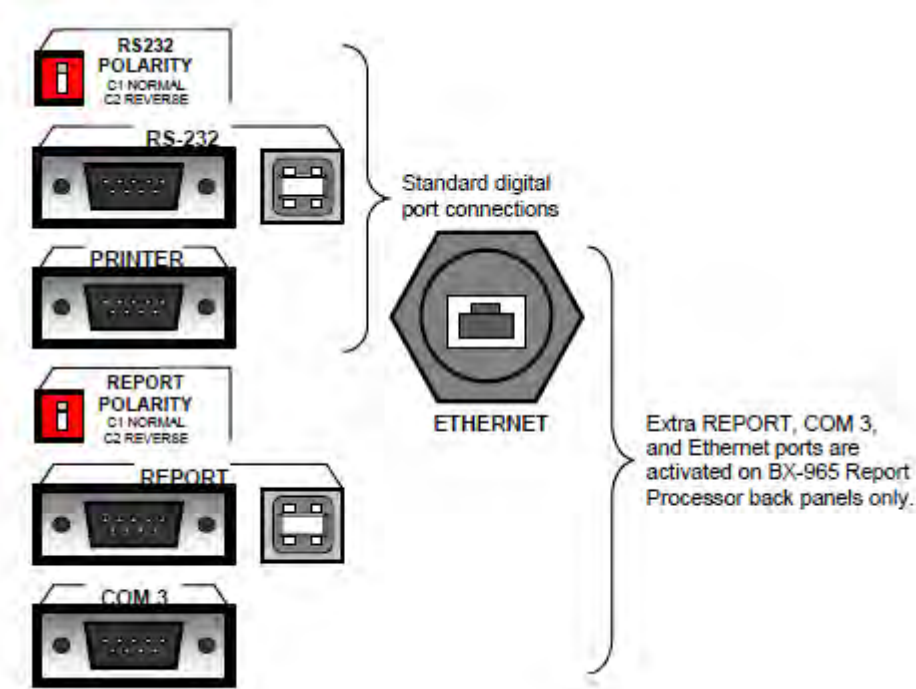

APDA-371 Back Panel Digital Connections

### 9.1 Direct Serial Port Connections and Settings

The “RS-232” serial port on the back of the APDA-371 handles data transfer directly from the APDA-371 CPU, and can be used for less intensive digital collection systems. Units with the newer Report Processor back panel option also have a second REPORT serial port and USB serial converters. The REPORT port has its own file service system which can’t be interrupted or ignored by the APDA-371 sample cycle, and should be used whenever available. Both the RS-232 and REPORT ports contain the same data files and are accessed in the same manner. The PRINTER port is output-only and is rarely used. The COM3 port is for connecting two APDA-371s together in PM-coarse systems only.

#### RS-232 Connections:

Most older desktop and laptop computers have a standard 9-Pin serial port available for communications. In these circumstances, the APDA-371 RS-232 or REPORT port can be directly connected to the serial port. Connect the port on the back of the APDA-371 to the COM port connector on the computer with the supplied APDA-371 serial cable (part 400658, female-to-female 9-pin null).



**CAUTION:** Do not confuse the parallel printer port or video adapter port on your computer with a serial port.

## USB Connections:

Most newer computers no longer have the 9-Pin serial communications port. In these situations, APDA-371 monitors may still be connected to the computers by using a USB to serial converter. Of the converters commonly available in local electronics and office supply stores, HORIBA has seen the most reliable performance from those manufactured by Belkin. Newer APDA-371 monitors (or older models with the optional Report Processor installed) will have an active USB port available on the back panel. Contact the HORIBA service department to obtain the necessary drivers for the computer to allow it to communicate with the APDA-371 in this manner.

## Communication Settings:

The APDA-371 communicates at 9600 Baud, 8 data bit, no parity, one stop bit, and no flow control. The default 9600 baud rate may be changed to a faster setting for downloading large APDA-371 data files, but in any case, the terminal program baud rate must match the APDA-371 baud setting. If unable to establish communications, try changing the RS-232 Polarity switch (or the Report Polarity switch, if using the REPORT connection) on the back of the APDA-371. This swaps the polarity of the TX and RX lines (pins 2&3) and functions as a null modem.

**NOTE:** *The APDA-371 user interface must be in the main top-level menu or OPERATE menu before any communication can be established through the RS-232 port. The LCD display and keypad on the APDA-371 are disabled whenever RS-232 communication with the CPU is in progress. The optional REPORT port does not have these limitations.*

## 9.2 HORIBA Communications Software

The APDA-371 is compatible with several communications software programs available from HORIBA:

**MicroMet® Plus:** A powerful and comprehensive data logging program for meteorological applications which is configurable to collect and manage all data from the APDA-371.

**Comet™:** A simple and easy to use communications terminal program which can retrieve data from HORIBA data loggers, including the APDA-371. This program replaces the old TUS (Terminal Utility Software) program.

### 9.3 Downloading Data Using Simple Terminal Programs

The APDA-371 data can be easily downloaded through the serial ports using HyperTerminal® or other simple terminal programs. Nearly all PCs have the HyperTerminal program already included. The following describes how to set up the program with the APDA-371:

1. Connect the RS-232 or REPORT port on the back of the APDA-371 to your computer or laptop using the appropriate cable. Connect to the COM1 serial port if available.
2. Open HyperTerminal. (Usually located in the Programs\Accessories\Communications directory). The program will ask you to type a name for the connection. Type "APDA-371" or a name of your choice, then click "OK".
3. The "Connect To" window will open. Select COM1 (or another port if used) from the drop-down menu in the "Connect Using" field. Click "OK". Note: You can also set up the program to dial the APDA through a modem in this window.
4. The "COM1 Properties" window will open. Set the following values in the drop-down menus, then click "Apply" and "OK".

**Bits per second: 9600**

**Data bits: 8**

**Parity: None**

**Stop bits: 1**

**Flow control: None**

5. The main HyperTerminal connection window should now be open. Press the ENTER key three times. The window should respond with an asterisk (\*) indicating that the program has established communication with the APDA-371.
6. Once communication is established, press the **h** key. This should cause the APDA-371 System Menu to appear on the window as shown below. You can now send any of the ASCII characters in the menu to retrieve the desired files. The menu options are described in the following section.
7. HyperTerminal will only display 100 lines of data in the window. To capture larger files (such as All Data), first select Transfer > Capture Text from the drop-down menu. Select a location for the file, then click the "Start" button. Retrieve the desired files, and HyperTerminal will automatically store them to the text file. Anything that comes through the terminal window will be saved to the file. Click the "Stop" button to stop capturing the text.
8. When you exit HyperTerminal, it will ask if you want to save your connection. Click "Yes" and a file named APDA-371.ht will be created in the HyperTerminal folder, which will have all of the settings saved. Use this for future communications with the APDA-371.

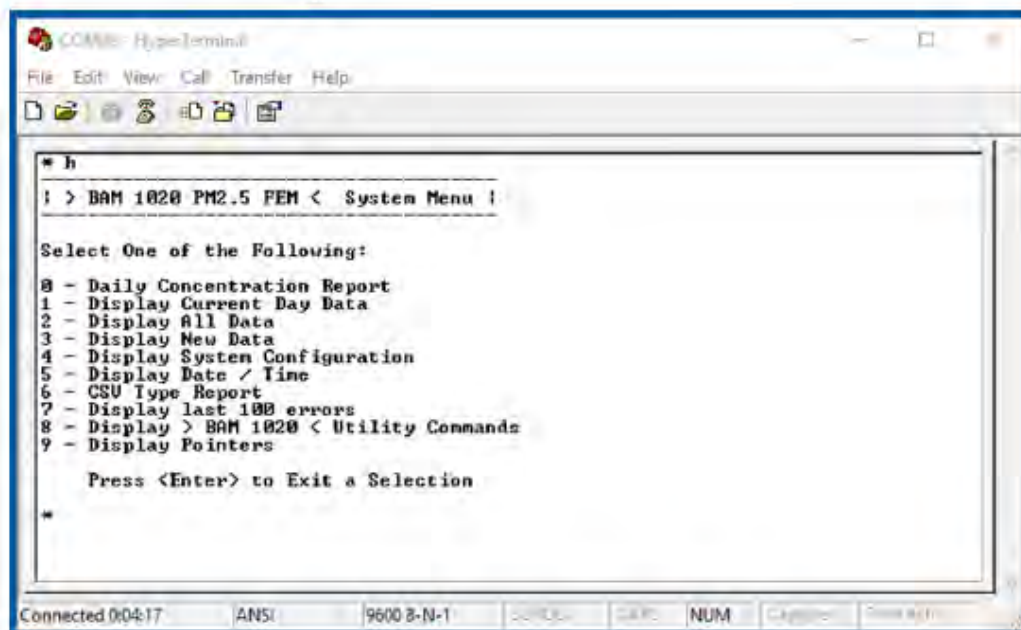

Terminal Window showing APDA-371 menu

## 9.4 System Menu and File Descriptions using a Terminal Program

Once a serial connection between a terminal program and the APDA-371 has been established as shown above, you will have access to the main APDA-371 System Menu. Each number 0-9 represents a different data file you can download from the APDA-371. Each file is described below. To get the desired file, simply press the appropriate number on your keyboard.

**NOTE:** After a few minutes, the APDA-371 will stop waiting for a command and you will have to press ENTER three times to reestablish the asterisk command prompt, then send another "h" to refresh the menu. If you already know the number of the file you want, you can skip the H menu altogether.

### File 0: Daily Concentration Report:

This file reports the daily concentration values. It provides the date, the daily concentration value, and the data percentage captured that day. Entering this menu option will display options for either all of the stored daily concentration data or just the new daily data captured since the last download. A data pointer is set in the APDA-371 indicating where the last download stopped. See Section 9.8. A typical daily concentration report looks like this:

```
Daily Conc Report
2018-05-31 12:16:55, 1
Date, Conc (mg/m3), Capture (%)
2018-05-25, 0.0001, 33
2018-05-26, 0.0012, 100
2018-05-27, 0.0007, 100
2018-05-28, 0.0007, 100
```



### Files 1, 2, and 3: Current Day Data, All Data, New Data:

These files are simple text views, and are for easy visual checks of the data only, because it is difficult to import these into a spreadsheet for analysis. An example of the data format is shown below.

File 1 Current Data is data from the current day only.

File 2 All Data is all of the data in the APDA-371 separated into daily blocks.

File 3 New Data is all data since the last download, also in daily blocks.

A data pointer is set in the APDA-371 indicating where the last download stopped. See Section 9.8.

The first data column is the time, followed by a series of dashes which represent error or alarm bits. If an error occurred, a letter representing the error will appear in this field. For this example, at 7:00 am an "L" error (power failure) occurred. Then at 8:00 an "M" error was logged, indicating that the operator was performing maintenance that hour.

The next column is the concentration. The Qtot column is total flow volume for the hour. With a flow rate of 16.70 L/min and a sample time of 50 minutes, this value will be about .834 m3 per hour. With a sample time of 42 minutes this value will be about 0.701 m3 per hour. The remaining six columns are the six data logger inputs on the APDA-371. In this example RH was logged on channel 4, and Ambient Temperature was logged on channel 6. The other four channels had nothing attached, but will appear in the array anyway. The data shown on the unused channels is only noise.

Report for 04/22/2005 - Day 112 > BAM 1020 < Station ID: 1

| Channel       |         | 01      | 02    | 03    | 04    | 05    | 06    |       |       |
|---------------|---------|---------|-------|-------|-------|-------|-------|-------|-------|
| Sensor        | Conc    | Qtot    | WS    | no    | WS    | RH    | WS    | AT    |       |
| Units         | mg/m3   | m3      | KPH   | V     | MPS   | %     | KPH   | C     |       |
| 01:00         | -----   | 0.010   | 0.834 | 019.6 | 0.012 | 000.3 | 00017 | 132.2 | 008.7 |
| 02:00         | -----   | 0.009   | 0.834 | 019.9 | 0.012 | 000.3 | 00018 | 132.1 | 007.4 |
| 03:00         | -----   | 0.011   | 0.834 | 019.8 | 0.012 | 000.3 | 00018 | 132.1 | 006.5 |
| 04:00         | -----   | 0.011   | 0.833 | 020.0 | 0.012 | 000.3 | 00018 | 132.1 | 006.1 |
| 05:00         | -----   | 0.012   | 0.833 | 019.8 | 0.012 | 000.3 | 00018 | 132.1 | 005.3 |
| 06:00         | -----   | 0.011   | 0.834 | 020.1 | 0.012 | 000.3 | 00018 | 132.0 | 005.6 |
| 07:00         | -L----- | 0.995   | 0.000 | 020.3 | 0.012 | 000.3 | 00018 | 132.0 | 007.4 |
| 08:00         | -M----- | 0.995   | 0.000 | 019.8 | 0.012 | 000.3 | 00017 | 132.1 | 009.4 |
| 09:00         | -----   | 0.008   | 0.833 | 019.9 | 0.012 | 000.3 | 00015 | 132.2 | 012.5 |
| 10:00         | -----   | 0.003   | 0.834 | 019.5 | 0.012 | 000.3 | 00014 | 132.2 | 016.2 |
| 11:00         | -----   | 0.007   | 0.833 | 019.5 | 0.012 | 000.3 | 00013 | 132.2 | 019.7 |
| 12:00         | -----   | 0.011   | 0.833 | 019.5 | 0.012 | 000.3 | 00012 | 132.0 | 020.7 |
| 13:00         | -----   | 0.008   | 0.833 | 019.1 | 0.011 | 000.3 | 00010 | 132.0 | 021.9 |
| 14:00         | -----   | 0.010   | 0.833 | 019.2 | 0.011 | 000.3 | 00010 | 131.9 | 022.3 |
| 15:00         | -----   | 0.020   | 0.833 | 019.1 | 0.011 | 000.3 | 00011 | 132.0 | 020.9 |
| 16:00         | -----   | 0.011   | 0.834 | 019.3 | 0.011 | 000.3 | 00012 | 132.1 | 018.7 |
| 17:00         | -----   | 0.010   | 0.833 | 019.5 | 0.012 | 000.3 | 00012 | 132.2 | 017.9 |
| 18:00         | -----   | 0.010   | 0.833 | 019.4 | 0.012 | 000.3 | 00012 | 132.1 | 017.1 |
| 19:00         | -----   | 0.010   | 0.834 | 019.4 | 0.012 | 000.3 | 00014 | 132.2 | 015.3 |
| 20:00         | -----   | 0.007   | 0.833 | 019.6 | 0.012 | 000.3 | 00015 | 132.1 | 014.4 |
| 21:00         | -----   | 0.006   | 0.834 | 019.5 | 0.012 | 000.3 | 00017 | 132.1 | 013.3 |
| 22:00         | -----   | 0.006   | 0.834 | 019.7 | 0.012 | 000.3 | 00021 | 132.0 | 011.2 |
| 23:00         | -----   | 0.005   | 0.833 | 019.6 | 0.012 | 000.3 | 00023 | 132.0 | 010.0 |
| 00:00         | -----   | 0.011   | 0.834 | 019.9 | 0.012 | 000.3 | 00017 | 132.2 | 009.5 |
| Savg          |         | 0.009   | 0.833 | 019.7 | 0.012 | 000.3 | 00015 | 132.1 | 013.2 |
| Vavg          |         | 0.000   | 0.000 | 000.0 | 0.000 | 000.0 | 00000 | 000.0 | 000.0 |
| Data Recovery |         | 100.0 % |       |       |       |       |       |       |       |

File 1 Current Day data text file example

### File 4: Display System Configuration (APDA Settings File):

This file contains a list of the APDA-371 settings and calibration values. This is useful for verifying the setup parameters and will most likely be requested by the factory if service is required. Following is an example of the File 4 settings report. Older revisions of APDA firmware may display a slightly different report format than the one shown on the next page.



EAM 1020 Settings Report  
08/21/2018 09:00:12

Station ID, 1  
Serial Number, P10558

Firmware, 3236-08 V3.14.2  
80350 Firmware, 80353-08 R2.6.0

K, 01.000  
BKGD, 0.0000  
usw, 00.285  
ABS, 00.890  
Range, 1.000  
Offset, -0.005  
Clamp, -0.005  
Conc Units, mg/m3  
Conc Type, ACTUAL  
Count Time, 4  
Conc Error, FULL SCALE VALUE  
Inlet Type, PM10

Cv, 01.000  
Qo, 00.000  
Flow Type, ACTUAL  
Flow Setpt, 0016.7  
Std Temp, 25

Heat Mode, AUTO  
FRH Ctrl, YES  
FRH SetPt, 35  
Low Power, 20  
FRH Log, YES  
FT Log, NO

EAM Sample, 50  
MET Sample, 1  
Cycle Mode, STANDARD  
Fault Polarity, NORM  
Reset Polarity, NORM  
Maintenance, OFF

HJ 653, NO

EUMILRNFPDCT  
llllllllllllll

AP, 000150  
Baud Rate, 9600  
Printer Report, 2  
e3, 00.000  
e4, 15.000

| Channel,     | 1,      | 2,     | 3,     | 4,     | 5,     | 6,     |
|--------------|---------|--------|--------|--------|--------|--------|
| Sensor ID,   | 255,    | 255,   | 255,   | 255,   | 255,   | 41,    |
| Channel ID,  | 255,    | 255,   | 255,   | 255,   | 255,   | 254,   |
| Name,        | BP,     | XXXXX, | Memb,  | FRH,   | XXXXX, | AT,    |
| Units,       | mHg,    | XXX,   | mg,    | %,     | XXX,   | C,     |
| Prec,        | 1,      | 0,     | 3,     | 0,     | 0,     | 1,     |
| FS Volts,    | 2.500,  | 1.000, | 2.500, | 0.500, | 1.000, | 2.500, |
| Mult,        | 300.0,  | 1,     | 4.095, | 32,    | 1,     | 100.0, |
| Offset,      | 525.0,  | 0,     | 0.000, | -26,   | 0,     | -50.0, |
| Vect/Scalar, | S,      | S,     | S,     | S,     | S,     | S,     |
| Inv Slope,   | N,      | N,     | N,     | N,     | N,     | N,     |
| Calibration, | Offset, | Slope, |        |        |        |        |
| Flow,        | 0.000,  | 1.000, |        |        |        |        |
| AT,          | 80.000, |        |        |        |        |        |
| BP,          | 0.000,  |        |        |        |        |        |
| FRH,         | 50.000, |        |        |        |        |        |
| FT,          | 0.000,  |        |        |        |        |        |

QUERY, 1, CONC\_A,  
Daily Range, 01:00 - 24:00  
Dynamic Range, EXTENDED  
Span Check, 1 HR  
Log BP, CHAN 1  
Log Membrane, CHAN 3

**File 4 System Configuration (Settings) File Example**

### File 5: Display Date / Time:

This file command will show the date and time of the APDA-371 real-time clock.

### File 6: CSV Type Report:

The CSV data menu is commonly used for APDA-371 data retrieval through terminal programs. The 6 command will respond with the sub-commands shown below. The data values in each file are separated by commas. This allows the text file to be opened directly by spreadsheets. This is the recommended data retrieval method. Be sure to capture text when downloading large files if using HyperTerminal. The CSV reports are also often used when APDA-371 data is downloaded by an external digital data logger. Following is a list of the sub-files available in CSV format. Sub files 5, 6, 7, and 8 are flow diagnostics files and are rarely used.

|                              |  |
|------------------------------|--|
| <b>2 – Display All Data</b>  | <b>(All data records in the APDA-371)</b>          |
| <b>3 – Display New Data</b>  | <b>(Data records since last download)</b>          |
| <b>4 – Display Last Data</b> | <b>(Previous hour's data only)</b>                 |
| 5 – Display All Flow Stats   | (All flow stats files)                             |
| 6 – Display New Flow Stats   | (Flow stats since last download)                   |
| 7 – Display All 5 Min Flow   | (5 minute averages of all flow stats)              |
| 8 – Display New 5-Min Flow   | (5 min averages of flow stats since last download) |
| <b>9 – Display Error Log</b> | <b>(Error/alarm log showing sub-categories)</b>    |

### Example of a CSV report of the "LAST DATA" record (File 6 sub-file 4):

The following example shows a typical CSV download of the file 6,4 last data record from the APDA-371, such as might be retrieved by an external digital data logger on an hourly basis. This file download does not reset the data pointer.

1. A series of three carriage returns is sent to the APDA-371 through the serial port. The APDA-371 responds with a single asterisk (\*) indicating that communication is established.
2. An ASCII character "6" is sent to the APDA-371 requesting the file 6 CSV menu. The APDA-371 responds with the CSV menu options as shown below, ending with ">".
3. An ASCII character "4" is sent to the APDA-371, requesting file 4 "Display Last Data". The APDA-371 responds with the Station ID number, then the header info, then the data record.

The data includes date/time stamp, concentration for the last hour (CONC), Flow volume for last hour (Qtot), then all six individual met sensor channels. The labels for these channels will vary, but will always appear in the data array regardless if used or not. In this example the six channels start with "WS" and end with "AT". At the end of the array are twelve error bits, each representing a different possible error. "0" indicates no error of that type, and "1" indicates an error.

```
* 6
CSV Type Reports

2 - Display All Data
3 - Display New Data
4 - Display Last Data

5 - Display All Flow Stats
6 - Display New Flow Stats

7 - Display All 5-Min Flow
8 - Display New 5-Min Flow

>4 - Display CSV Data
Station, 5
Time,Conc(mg/m3),Qtot(m3),WS(MPS),WD(DEG),BP(mm),RH(%),Delta(C),AT(C),E,U,M,I,L,R,N,F,P,D,C,T
01/30/08 16:00, 0.084, 0.834, 0.0,0,0,30,57.0,27.1,0,0,1,0,0,0,0,0,0,0,0,0,1,
```

**Example of CSV last data report**



### CSV Reports of Flow Statistics and 5-Min Flow Files:

The flow statistics fields available in the CSV menu are described below. These files are not available except on APDA units configured as FEM PM2.5 units. A BX-596 sensor is required. The flow statistics files are typically used for diagnostics only.

| Field   | Description  |
|---------|--|
| Start   | Start time of BAM sample period.                             |
| Elapsed | Elapsed BAM sample time.                                     |
| Flow    | Average flow rate for the BAM sample period.                 |
| CV      | Flow rate coefficient of variance for the BAM sample period. |
| Volume  | Sample volume for the BAM sample period.                     |
| Flag    | Flow regulation out of range warning flag.                   |
| AT      | Average ambient temperature for the BAM sample period.       |
| AT Min  | Minimum ambient temperature for the BAM sample period.       |
| AT Max  | Maximum ambient temperature for the BAM sample period.       |
| BP      | Average ambient pressure for the BAM sample period.          |
| BP Min  | Minimum ambient pressure for the BAM sample period.          |
| BP Max  | Maximum ambient pressure for the BAM sample period.          |

The 5-minute flow statistics averages are described below. These files are not available except on APDA units configured as FEM PM2.5 units. A BX-596 sensor is required.

| Field | Description   |
|-------|---|
| Time  | Event time stamp in seconds since January 1, 1970 00:00:00      |
| Flow  | 5 Minute average flow rate for the BAM sample period.           |
| AT    | 5 Minute average ambient temperature for the BAM sample period. |
| BP    | 5 Minute average ambient pressure for the BAM sample period.    |
| FP    | 5 Minute average filter pressure for the BAM sample period.     |

### File 7: Display Last 100 Errors (Error Log):

This file contains the date, time, and a description of each of the last 100 errors logged by the APDA-371, in text format. This file reports the 12 main alarm categories only, but not the sub-categories showing the more specific alarm cause. For this reason, the csv error log file should be used instead (file 6 sub-file 9). This file should be downloaded to identify the exact sub-category of any errors or alarms which are not immediately evident.

### File 8: Display APDA-371 Utility Commands:

This file contains a list of ASCII commands can be sent to the APDA-371 through the serial port to configure certain parameters or to perform advanced diagnostics. Most of these commands will not be used by the typical operator unless instructed by a factory technician. Some of these commands require a password to access. The password is the same as the F-key sequence used to enter SETUP screens (default password is 1 2 3 4). The functions are shown in the table below.

| Command  | Command Function   |
|----------|--|
| <b>a</b> | Printer Port Output Configuration. This sets what is output on the printer port. Sending this command will prompt the following sub-menu:<br>1 – Printer Port (default).<br>2 – Standard Diagnostic Port.<br>3 – Factory Diagnostic Port.<br>4 – Comma Separated Data Output Port. |
| <b>c</b> | Clear Data Memory. This serial command erases all stored data from memory! Password required.  |
| <b>d</b> | Set Date. This sets the date on the BAM 1020. Password required.   |
| <b>e</b> | Display Hex EEPROM Setup Values. This displays the special memory locations where the setup values are stored. Diagnostic only.  |
| <b>f</b> | Factory Calibration Test. This is used for factory calibration only!   |
| <b>h</b> | Display System Menu. This is the command used to access the data downloading menu options. Become familiar with this command.  |
| <b>i</b> | Display ID Values. This command displays the ID codes of the met sensors for diagnostic purposes.  |
| <b>m</b> | Display Hex Data Memory Values. This command displays the data memory locations for diagnostic purposes.   |
| <b>p</b> | Modify Modem Pointer. Factory use only.  |
| <b>q</b> | Display Station ID. This command displays the preset station ID number.  |
| <b>t</b> | Set Time. This command sets the time on the BAM 1020. Password required.   |
| <b>b</b> | XMODEM Data Download. This command allows binary data transfer of the BAM 1020 memory. Download only. Requires software handshaking. For use with special software only, not terminal programs. Advanced use only.   |
| <b>r</b> | XMODEM Real-Time Value Download. This command is only used by special software to scan instantaneous values of sensors, alarms and settings. Requires software handshaking. Advanced use only.   |
| <b>x</b> | XMODEM EEPROM Value Download. This command allows quick scanning of non-volatile memory for diagnostic purposes. Advanced use only.  |
| <b>z</b> | Enable concentration report to PRINTER output. This command configures the printer port to output a fixed-width concentration report at the end of the sample period. For external loggers. Available in firmware 3.2 or later only.   |

### File 9: Display Pointers:

This file is a display of the current status of the data storage memory. The current pointer position and number of full memory locations is shown. Rarely used.



## 9.5 Printer Output Port

The Printer port on the back of the APDA-371 is an output-only RS-232 serial interface which may be used with a serial printer or as a diagnostic output to a computer. The printer port output can be configured by using the “a” utility command through the main RS-232 port. (See section 9.4) The output may be set for data printouts, fixed-width data output, or one of two diagnostic modes. Diagnostic modes are not used except by a factory technician.

A new configuration has been added for the printer port which enables it to output a fixed-width concentration report at the end of the sample period, which can be used to interface to a serial data logger. This output is enabled by using the “z” utility command through the serial port. The output format is date, time, concentration, and flow volume as shown below.

|                                 |   |
|---------------------------------|---|
| Format in mg/m <sup>3</sup> is: | <b>mm/dd/yy hh:mm:ss,+99.999,+9.999</b> |
| Format in μg/m <sup>3</sup> is: | <b>mm/dd/yy hh:mm:ss,+999999,+9.999</b> |

If the APDA is set to STANDARD cycle mode, the output will occur at the top of the next hour. For example, if a measurement is made over hour 2, then the format would be:

03/28/07 03:00:00, +00.027,+0.834

If the APDA is set to EARLY cycle mode, the output will occur at minute 55:00 for the current hour. For example, if a measurement is made over hour 2, then the format would be:

03/28/07 02:55:00, +00.027,+0.834

## 9.6 Modem Option

The BX-996 modem is recommended for use with the APDA-371, as it is designed to reliably communicate when other modems may not. If a different modem is used, it must be set in “dumb terminal” mode or equivalent because the APDA-371 does not support handshaking with the modem.

**NOTE:** *The RS-232 Polarity switch on the back of the APDA-371 may need to be set to REVERSE polarity for communication using the modem.*

If you are using one of the data acquisition programs such as MicroMet Plus, Air Plus 5, or Comet you need only enter the telephone number of the site in the system setup menu of the program. Multiple telephone numbers can be entered for connection to multiple remote sites. After connection, the data collection is the same as it would be with a direct serial connection to the APDA-371.

If you are communicating with a terminal program such as HyperTerminal® or ProComm Plus® you will need to define the serial port configuration in the setup of the program. Set the baud rate to 9600, with 8 data bits, no parity, and 1 stop bit. Use the terminal program’s internal dialing command sequence to dial up the APDA-371. Verify the connection to the APDA-371 by pressing the <Enter> key at least three times until the command prompt asterisk (\*) appears. If not, verify the cabling and communications settings. Once connected, the access to the APDA-371 is the same ASCII menu driven interface as used for the direct PC connection.

## 9.7 APDA-371 Firmware Upgrades

The APDA-371 has a system of one or more firmware (embedded software) programs located in one or more EEPROM chips that control the operation of the APDA-371. There are also several different possible versions of these firmware programs depending on the intended configuration of the APDA-371.

The APDA-371 CPU board in all units runs at least the main instrument control firmware program (part number 3236-X), which can be updated through the RS-232 port. The optional BX-965 Report Processor back panel board has its own firmware (part number 80353-X), which can be updated through the REPORT port. The following is a basic table of the different firmware programs:

| Part Number | Ver/Rev Series        | Description   |
|-------------|-----------------------|---|
| 3236-02     | V 3.X.X (and earlier) | PM10-only firmware for main CPU. Units without touch screen.                                |
| 3236-02     | V 3.4.X               | PM10 and PM2.5 FEM (USA type) firmware for main CPU. Units without touch screen.            |
| 3236-05     | V 3.X.X               | PM2.5 FEM (USA type) firmware for main CPU. Units without touch screen.                     |
| 3236-06     | V 3.X.X               | PM-Coarse FEM firmware for main CPU. Units without touch screen.                            |
| 3236-07     | V 5.X.X               | PM10 & PM2.5 EU (Euro type) firmware for main CPU. Units without touch screen.              |
| 3236-55     | V 4.X.X               | PM2.5, PM10, & Coarse FEM (USA type) firmware for main CPU, units with touch screen only.   |
| 3236-77     | V 5.X.X               | PM2.5 & PM10 EU (Euro type) firmware for main CPU, units with touch screen only.            |
| 80353-1     | V 1.X.X               | BX-965 Report Processor firmware, older units with HC11 processor only                      |
| 80353-3     | R 2.X.X               | BX-965 Report Processor firmware, units with HC12 processor, all units except touch screen. |
| 80353-4     | R 2.X.X               | BX-965 Report Processor firmware, for all units with BX-970 touch screen.                   |
| 80596       | V 2.X.X               | BX-970 Touch Screen panel PC software.  |



**CAUTION!** *The compatibility and interactivity of these various firmware programs is complex. Some firmware versions and/or revisions are incompatible with others, and upgrading one program may require upgrading other programs in order to maintain compatibility. Please contact HORIBA technical service in order to ensure that you have the correct files before attempting to upgrade any firmware.*

The APDA-371 has the capability for flash firmware upgrades through the serial ports. Flash updates allow the field operator to easily reprogram the main EEPROM firmware to the latest revision through the serial port using the Flash Update Utility. Units which currently run firmware revision 3.0 or later already have a flash compatible EEPROM. If the APDA-371 has old revision 2.58 or earlier firmware, then you will need to physically replace the EEPROM chip with a flash compatible chip available from HORIBA.

You will need a computer or laptop with an RS-232 (9-pin) serial COM port and the standard APDA-371 serial cable that came with the APDA-371. Laptops without a 9-pin COM port will need a reliable USB-to-RS-232 converter, or a USB cable can be used if your APDA-371 has the USB converter port on the back. Do not update the firmware over a modem.

**NOTE:** *The main APDA-371 operating system firmware is always updated through the standard RS-232 port only. The Report Processor back panel option has its own EEPROM, its own processor, and its own memory. The Report Processor firmware can be flash updated through the REPORT port, in a similar manner to the main APDA-371 firmware.*



**CAUTION!** *Take great effort to ensure that the power source to the APDA-371 will not be interrupted during the flash firmware update process! A power interruption may cause the firmware to become inoperative, and the APDA-371 will have to be returned to the factory!*

### Before the flash firmware update:

- Download and save all APDA-371 data and error logs. These files will be erased from memory during the upgrade process!
- Download the APDA-371 settings file, or at least record your current settings in the SETUP > SAMPLE and SETUP > CALIBRATE screens.

**NOTE:** *If the APDA-371 already has revision 3.2 or later firmware, then none of the settings or calibrations should be affected by the update process.*

- Set the APDA-371 baud rate to 9600 for the flash update process.

### Flash Update Process:



**CAUTION!** *The flash update process should only be performed by a trained service technician. Please contact HORIBA service.*

### After the flash firmware update:

- Check or set the APDA-371 baud rate back to the desired rate for regular data collection.
- Reset the calibration of the filter temperature and filter RH sensors. Default and then recalibrate the ambient temperature, pressure and flow in the TEST > FLOW screen.

**NOTE:** *Sometimes false field calibration values can end up in these parameters as a result of firmware updates, and they must be cleared out for proper APDA-371 operation.*

Check and verify the settings in the SETUP > SAMPLE and SETUP > CALIBRATE screens to ensure that they are still correct. It is always good practice to review all settings after any firmware update.

## 9.8 Resetting the Data Pointer for New Data Collection

The APDA-371 sets a data pointer when data files are retrieved. The pointer indicates the last data record collected, so that next time “new data” is retrieved, only data back to that pointer is sent. This prevents collecting redundant data and needlessly large files. It is sometimes helpful to be able to manually reset this pointer back to a specific record if it becomes incorrectly set, such as if a modem hangs up in the middle of a download. APDA-371 firmware rev 3.2.6 and later allows the data pointer to be manually reset by sending an escape command through the serial port.

**NOTE:** *The REPORT port on the optional Report Processor back panel uses different pointer reset commands. See the BX-965 manual.*

The reset command is **<esc>FH<cr>** where **<esc>** is the esc key. F is the desired file number of **3** (data log file), **6** (flow stats file), or **8** (5-min flow file). H is the number of hours back from current to set the pointer (1 to 9999). **<cr>** is the enter key.

For example, sending **<esc>3 24<cr>** through the RS-232 port would set the data pointer of the main APDA-371 data memory back to 24 hours ago.

The daily concentration values pointer may also be reset in a similar manner using the command **<esc>0 D<cr>** where **<esc>** is the esc key. **0** is the daily concentration log file, and **D** is the number of days back from the current set point. The time is always set as 00:00:00, the start of the day.



## 9.9 Data Collection Using the Query Output or Bayern-Hessen Protocol

APDA-371 units equipped with revision 3.6.3 or later firmware are capable of outputting the custom Query digital data array. European units with revision 5 series firmware are compatible with the Bayern-Hessen data protocol. The format of the Query or BH data array outputs is determined by the user-selected parameters in the SETUP > QUERY menu as described in Section 6.10.

**NOTE:** The Query output can only be accessed through the REPORT serial port on the optional BX-965 Report Processor back panel.

### Bayern-Hessen “BH” Protocol:

The Bayern-Hessen protocol is used to support certain European data networks. The complete protocol is not described in this manual, but is available a separate technical document. The primary difference between the Query and the BH data configurations is that the BH protocol does not support the time/date field used in the Query array, but the BH protocol does support a diagnostic stability field which is not accessible with the Query array.

In addition, the BH protocol can only accommodate eight alarm types (0-7) instead of the standard twelve, so some of the alarm states are grouped together. The BH protocol also supports eight real-time status bits to indicate which part of the sample cycle is in progress.

### Custom Query Output:

The Query output is provided to allow easier configuration of digital data logger and more flexibility in the APDA-371 digital output array. The Query output array is set to include only the desired parameters in the desired order, and is accessed with a simple escape command sequence. This eliminates much of the work associated with programming a digital data logger to establish a command prompt, navigate the classic digital menu system, and parse out multiple unused data parameters.

No command prompt must be established with the APDA-371 as with the classic digital menu access commands. Only the <Esc> escape character (hex 1B) or the <STX> character (hex 02) followed by the desired Query file and a carriage return (enter). The resulting Query output from the APDA-371 will consist of the last data record in the APDA-371 memory, in comma-separated format. The available Query commands are listed below:

| Escape Command    | Description   |
|-------------------|---|
| <Esc> QC <enter>  | Custom Query output. Data is formatted exactly as specified in the SETUP > QUERY screen. All values are in comma separated format, with a fixed width of 7 characters per field excluding commas.   |
| <Esc> QCH <enter> | Data header for the custom Query output.  |
| <Esc> Q <enter>   | Standard Query output. Data array configured exactly like the standard csv last data output (menu 6,4) regardless of the Query setup screen. All values are in comma separated format, with a fixed width of 6 characters per field excluding commas. |
| <Esc> QH <enter>  | Data header for the standard Query output.  |

An example of one possible QCH (custom array header) and QC (custom Query array) command are shown below. Each escape command is followed by the response from the APDA-371:

```
<Esc>QCH
TIME,CONC(mg/m3),FLOW(lpm),AT(C),BP(mmHg),RH(%),REF(mg),ERRORS,*4348
<Esc>QC
07/06/10 13:22, 0.0230, 16.7, 23.6, 761, 26, 0.8160, 0,*3129
```

An example of the QH and Q commands is shown below. This mirrors the familiar csv last data output of the APDA-371, and ignores the user set format of the custom Query array:

<Esc>QH

Time,Conc(mg/m3),Qtot(m3),WS(KPH),WS(MPS),WS(MPS),RH(%),Delta(C),AT(C),E,U,M,I,L,R,N,F,P,D,C,T,\*6451

<Esc>Q

07/06/10 15:00, 0.023, 0.701, 0.8, 0.8, 0.8, 26, 8.6, 23.6,0,0,0,0,0,0,0,0,0,0,0,\*4224

If the error status is included in the custom Query array (QC), it will appear as a decimal error code as shown below. Each decimal code value corresponds to one of the twelve regular APDA-371 error or alarm types as described in Section 7.2.

| Decimal Code | Error Flag | Description                       |
|--------------|------------|-----------------------------------|
| 0            | none       | No error                          |
| 1            | T          | Tape System Errors                |
| 2            | C          | Beta Count Error                  |
| 4            | D          | Deviant Membrane Density Alarm    |
| 8            | P          | Pressure Drop Alarm               |
| 16           | F          | Flow Errors                       |
| 32           | N          | Nozzle Error                      |
| 64           | R          | Reference Error, Membrane Timeout |
| 128          | L          | Power Failure                     |
| 256          | I          | Internal Error, Coarse Link Down  |
| 512          | M          | Maintenance Flag                  |
| 1024         | U          | Telemetry Fault                   |
| 2048         | E          | External Reset Error              |



A data integrity checksum is included at the end of each Query array, after the delimiter asterisk character '\*'. The checksum is the 16-bit arithmetic sum of all characters in the line up to but not including the asterisk.

**NOTE:** Digital data loggers may be programmed to use the <STX> (hex 02) character instead of the <ESC>, to prevent the echoing of the command back to the logger.





## 10 ACCESSORIES and PARTS

### 10.1 Consumables, Replacement Parts, and Accessories



The following parts are available from HORIBA for maintenance, replacement, service, and upgrades. If unsure about a part you need, please contact the Service department. Some of these parts require technical skills or special considerations before use or installation.

| Description  | Part Number   | Graphic   |
|--|---------------|---|
| <b>Consumables</b>   |               |   |
| Filter Tape Roll, Glass Fiber, 60+ days per roll<br>30mm x 25 m    | <b>460180</b> |  |
| Cotton-Tipped Applicators, nozzle cleaning, 100 pack<br>Solon #362 | <b>995217</b> |  |



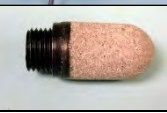

#### Tools

|   |               |   |
|---|---------------|---|
| APDA-371 Service Tool Kit: Includes nozzle shims, spring scales, reel spacer, filter sensor removal tool                          | <b>BX-308</b> |   |
| Leak Test Rubber Nozzle Seal  | <b>7440</b>   |   |
| Membrane Assembly, Replacement, 0.800 mg/cm <sup>2</sup>  | <b>8069</b>   |   |
| Membrane Assembly, Mid-Range, 0.500 mg/cm <sup>2</sup>  | <b>BX-301</b> |   |
| Mass Flow Calibration Kit, 0-20 SLPM  | <b>BX-303</b> |   |
| Flow Inlet Adapter Kit (Leak Test Valve)<br>Includes short inlet tube   | <b>BX-305</b> |  |
| Zero Filter Calibration Kit, with valve<br>Required for PM2.5 FEM monitoring<br>Same as BX-305 but with 0.2 micron filter         | <b>BX-302</b> |  |
| Volumetric Flow Calibration Kit (BGI Delta Cal™)<br>Flow, Temp, and Pressure Reference Standards<br>HORIBA recommended flow meter | <b>BX-307</b> |  |

### Pumps and Pump Parts

|  |               |   |
|--|---------------|---|
| Pump, Medo, 115 VAC, 50/60 Hz, Low Noise   | <b>BX-126</b> |  |
| Pump, Medo, 230 VAC, 50/60 Hz, Low Noise   | <b>BX-127</b> |   |
| Pump, Gast, Rotary Vane, 100 VAC, 60 Hz    | <b>BX-123</b> |  |
| Pump, Gast, Rotary Vane, 115 VAC, 50/60 Hz | <b>BX-121</b> |   |
| Pump, Gast, Rotary Vane, 230 VAC, 50 Hz    | <b>BX-122</b> |   |
| Pump, Gast, Rotary Vane, 230 VAC, 60 Hz    | <b>BX-124</b> |   |
| Muffler, Medo/Gast Pump, Replacement       | <b>580293</b> |  |
| Pump Rebuild Kit, Gast                     | <b>680828</b> |   |
| Pump Rebuild Kit, Medo                     | <b>680839</b> |   |
| Pump Service Kit, Filter Replacement, Medo | <b>8588</b>   |   |
| Pump Controller (Relay Module) Medo/Gast   | <b>BX-839</b> |   |

### Flow Components

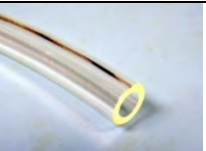
|   |               |   |
|---|---------------|---|
| Flow Sensor, Mass, 0-20 LPM, Internal Assembly                                | <b>80324</b>  |    |
| Flow Controller Assembly, Replacement Only                                    | <b>8776</b>   |   |
| Automatic Flow Controller Upgrade Kit   | <b>BX-961</b> |   |
| Filter Assembly, Pisco In-line  | <b>580291</b> |  |
| Filter Element Only, Pisco In-line  | <b>580292</b> |   |
| Filter Temperature and RH Sensor Kit  | <b>BX-962</b> |  |
| Filter RH Sensor Replacement Only   | <b>9278</b>   |   |
| Filter Temperature Sensor Replacement Only                                    | <b>9279</b>   |   |
| Nozzle, Stainless Steel, Replacement Part                                     | <b>8009</b>   |  |
| Nozzle Spring, Replacement  | <b>2998</b>   |   |
| O-Ring, Nozzle  | <b>720066</b> |   |
| O-Ring, Inlet Receiver, 2 required  | <b>720069</b> |   |
| O-Ring Kit, APDA  | <b>9122</b>   |   |
| Pump Tubing, Clear, 10mm O.D., 6.5mm I.D. Polyurethane, 25 foot roll standard | <b>960025</b> |  |

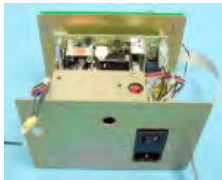

### Electrical and Electronic Parts

|  |               |   |
|--|---------------|---|
| Display, LCD, Front Panel                    | <b>2823</b>   |   |
| Circuit Board, CPU                           | <b>3230-8</b> |   |
| Circuit Board, Interface                     | <b>3250-1</b> |   |
| Circuit Board, Rear Panel Interconnect       | <b>3260-1</b> |   |
| Fuse, APDA-371, 3.15A, 250V, 5x20mm, 2 Req'd | <b>590811</b> |   |
| Motor, with gear box, 4 RPM                  | <b>8105-1</b> |  |
| Motor, with gear box, 10 RPM                 | <b>8106-1</b> |   |
| Power Supply, 115 VAC, 60 Hz                 | <b>BX-115</b> |  |
| Power Supply, 115 VAC, 50 Hz                 | <b>BX-116</b> |   |
| Power Supply, 230 VAC, 60 Hz                 | <b>BX-230</b> |   |
| Power Supply, 230 VAC, 50 Hz                 | <b>BX-231</b> |   |
| Power Supply, 100 VAC, 60 Hz                 | <b>BX-100</b> |   |
| Power Supply, 100 VAC, 50 Hz                 | <b>BX-101</b> |   |





### Inlet Components

|  |               |   |
|--|---------------|---|
| PM10 Inlet Head, EPA Specified   | <b>BX-802</b> |    |
| TSP Sampling Inlet Cap, with bug screen  | <b>BX-803</b> |   |
| PM2.5 Sharp Cut Cyclone  | <b>BX-807</b> |  |
| PM2.5 Very Sharp Cut Cyclone, BGI Inc. VSCC™<br>Required for PM2.5 FEM monitoring                            | <b>BX-808</b> |   |
| PM2.5 WINS Impactor  | <b>BX-804</b> |   |
| Inlet Roof Mounting Kit, with waterproof roof flange, inlet tube and braces. Specify tube length, 8 feet std | <b>BX-801</b> |  |
| Inlet Tube Coupler Assembly, with o-rings<br>Connects two inlet tubes together<br>Inlet tube sold separately | <b>BX-821</b> |  |
| Inlet Tube Extension Kit, 4 foot, with coupler and tube  | <b>BX-822</b> |  |
| Inlet Tube Extension Kit, 8 foot, with coupler and tube  | <b>BX-823</b> |   |
| Inlet Tube, Aluminum, 8 foot length standard   | <b>8112</b>   |  |
| Inlet Tube, Custom Length<br>Dash number is length in feet, 8' max per tube                                  | <b>8112-X</b> |   |
| Smart Heater Option, 115 VAC   | <b>BX-827</b> |   |
| Smart Heater Option, 230 VAC   | <b>BX-830</b> |   |



|   |               |   |
|---|---------------|---|
| Smart Heater Upgrade Kit, 115VAC  | <b>9307</b>   |  |
| Smart Heater Upgrade Kit, 220VAC  | <b>9308</b>   |   |
| APDA Inlet Cleaning Kit<br>Includes pull-rope, tube brush, microfiber rags, cleaning brushes, o-ring grease, cotton applicators.<br>For cleaning inlet tube and PM10, PM2.5 inlets. | <b>BX-344</b> |  |
| O-Rings, Cyclone, set of 6  | <b>720097</b> |   |
| O-Rings, PM10 Head, set of 3  | <b>8965</b>   |   |

### Meteorological Sensors

|   |               |   |
|---|---------------|---|
| 590 Wind Direction Sensor, Auto ID                          | <b>BX-590</b> |   |
| 591 Wind Speed Sensor, Auto ID                              | <b>BX-591</b> |   |
| 592 Ambient Temperature Sensor                              | <b>BX-592</b> |    |
| 593 Ambient Relative Humidity Sensor                        | <b>BX-593</b> |   |
| 594 Ambient Barometric Pressure Sensor, Auto ID             | <b>BX-594</b> |  |
| 595 Solar Radiation Sensor, Auto ID                         | <b>BX-595</b> |   |
| 596 AT/BP Combo Sensor<br>Required for PM2.5 FEM monitoring | <b>BX-596</b> |  |
| Real-Time Module (RTM), APDA Inlet Particle Sensor          | <b>BX-894</b> |  |

### Communications Components and Misc. Accessories

|   |                                |  |
|---|--------------------------------|--|
| Serial Printer Kit  | <b>BX-601</b>                  |  |
| Converter for Parallel Printers   | <b>BX-602</b>                  |  |
| Modem Kit   | <b>BX-996</b>                  |  |
| Serial Cable, 6', DB-9 female/female, null, APDA to PC  | <b>400658</b>                  |  |
| Belkin F5U109 USB-to-RS-232 Adapter   | <b>550067</b>                  |  |
| Enclosure, Outdoor, Heated, Mfg by Shelter One  | <b>BX-902</b>                  |  |
| Enclosure, Outdoor, Heated and Air Conditioned<br>Mfg by Ekto. Available with 2000 or 4000 BTU A/C. | <b>BX-903</b><br><b>BX-904</b> |  |

## 10.2 BX-500 Series Sensor Configurations

The APDA-371 has six channels of inputs available on the back of the APDA-371 for data logging external sensors. The BX-500 Series sensors are a set of meteorological sensors designed for direct compatibility with these channels. The sensors each have an auto-identification (ID) signal wire with a voltage unique to that type of sensor. When one of these sensors is attached to the APDA-371, the APDA-371 senses this ID voltage and automatically configures the channel with all the correct scaling parameters.

**The ID MODE for the desired channel must be set to AUTO in the SETUP > SENSORS menu in order for the APDA-371 to identify the sensor.**

See Section 6.8 for details about setting up the channels in the APDA-371. The scaling and setup values of the series BX-500 sensors are shown in the chart below.

### Temperature Input for Flow Control:

The ambient temperature signal used for APDA-371 flow control must always be connected to channel six. APDA-371 units are equipped with at least a BX-592 ambient temperature sensor. If the APDA-371 is configured as a PM2.5 FEM monitor, then the BX-596 sensor is required. This is a combination ambient temperature and barometric pressure sensor which attaches to channels six (AT) and seven (BP) for actual flow control and flow statistics. *The channel 7 pressure signal is not logged in the standard APDA-371 data arrays.* In order to log the barometric pressure from the BX-596, you must jumper the channel 7 signal terminal over to another unused channel input with a short wire. Then you must manually scale the second channel with the multiplier, offset, and full scale voltage of the BX-596 as shown below. BX-596-1 is an special extended range version for very low temperature or high altitude locations. BX-597 has an additional ambient RH signal and extended ranges on the other parameters.

| 500 Series Sensor Setup Parameters |      |         |                 |        |        |          |     |           |            |
|------------------------------------|------|---------|-----------------|--------|--------|----------|-----|-----------|------------|
| Model                              | Type | Units   | Range           | Mult   | Offset | FS Volts | S/V | Inv Slope | ID Voltage |
| BX-590                             | WD   | Deg     | 0 to 360        | 360    | 0      | 1.0      | V   | N         | 1.10v      |
| BX-591                             | WS   | mph     | 0 to 100        | 100    | 0      | 1.0      | S   | N         | 0.20v      |
|                                    |      | m/s     | 0 to 44.704     | 44.70  | 0      | 1.0      | S   |           |            |
| BX-592                             | AT   | °F      | -22 to +122     | 144    | -22    | 1.0      | S   | N         | 1.80v      |
|                                    |      | °C      | -30 to +50      | 80     | -30    | 1.0      | S   |           |            |
| BX-593                             | RH   | %       | 0 to 100        | 100    | 0      | 1.0      | S   | N         | 2.10v      |
| BX-594                             | BP   | inHg    | 20 to 32        | 6      | 26     | 1.0      | S   | N         | 2.60v      |
|                                    |      | mmHg    | 508.0 to 812.8  | 152.40 | 660.40 | 1.0      | S   |           |            |
|                                    |      | mbar    | 677.1 to 1083.6 | 203.19 | 880.46 | 1.0      | S   |           |            |
| BX-595                             | SR   | Ly/ min | 0 to 2          | 2      | 0      | 1.0      | S   | N         | 3.70v      |
|                                    |      | W/M2    | 0 to 2000       | 2000   | 0      | 1.0      | S   |           |            |
| BX-596                             | AT   | °C      | -40 to +55      | 95     | -40    | 2.5      | S   | N         | 3.50v      |
|                                    | BP   | mmHg    | 525 to 825      | 300    | 525    | 2.5      | S   |           |            |
| BX-596-1                           | AT   | °C      | -50 to +50      | 100    | -50    | 2.5      | S   | N         | 4.10v      |
|                                    | BP   | mmHg    | 400 to 825      | 425    | 400    | 2.5      | S   |           |            |
| BX-597                             | AT   | °C      | -50 to +70      | 120    | -50    | 2.5      | S   | N         | 4.20v      |
|                                    | BP   | mmHg    | 375 to 825      | 450    | 375    | 2.5      | S   |           |            |
|                                    | RH*  | %       | 0 to 100        | 100    | 0      | 2.5      | S   |           |            |

\* The RH signal from the BX-597 sensor may optionally be connected to an unused met channel. These setup parameters must be manually entered by the user in the SETUP > SENSOR screen for the selected channel.

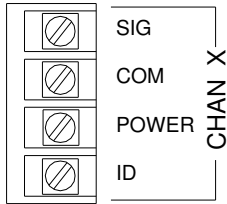

**APDA-371 Back Panel Sensor Input Terminal**



## BX-500 Series Sensor Wiring Connections for APDA-371

| BX-590 Wind Direction Sensor |                  |
|------------------------------|------------------|
| Terminal Block               | Cable Wire Color |
| SIG                          | Yellow           |
| COM                          | Black/Shield     |
| POWER                        | Red              |
| ID                           | Green            |

| BX-591 Wind Speed Sensor |                  |
|--------------------------|------------------|
| Terminal Block           | Cable Wire Color |
| SIG                      | Yellow           |
| COM                      | Black/Shield     |
| POWER                    | Red              |
| ID                       | Green            |

| BX-592 Ambient Temp Sensor |                  |
|----------------------------|------------------|
| Terminal Block             | Cable Wire Color |
| SIG                        | Yellow           |
| COM                        | Black/Shield     |
| POWER                      | Red              |
| ID                         | Green            |

| BX-593 Relative Humidity Sensor |                  |
|---------------------------------|------------------|
| Terminal Block                  | Cable Wire Color |
| SIG                             | Yellow           |
| COM                             | Green/Shield     |
| POWER                           | White            |
| ID                              | Red              |

| BX-594 Barometric Pressure Sensor |                  |
|-----------------------------------|------------------|
| Terminal Block                    | Cable Wire Color |
| SIG                               | White            |
| COM                               | Black/Shield     |
| POWER                             | Red              |
| ID                                | Yellow           |

| BX-595 Solar Radiation Sensor |                  |
|-------------------------------|------------------|
| Terminal Block                | Cable Wire Color |
| SIG                           | Yellow           |
| COM                           | Black/Shield     |
| POWER                         | Red              |
| ID                            | Green            |

| BX-596 Temperature/Pressure Combo Sensor |                  |
|--|------------------|
| Terminal Block                           | Cable Wire Color |
| Channel 6 SIG                            | Yellow           |
| Channel 6 COM                            | Black/Shield     |
| Channel 6 POWER                          | Red              |
| Channel 6 ID                             | Green            |
| Channel 7 SIG                            | White            |
|  |                  |

| BX-597 Temperature/Baro/RH Combo Sensot |                  |
|---|------------------|
| Terminal Block                          | Cable Wire Color |
| Channel 6 SIG                           | Blue (AT)        |
| Channel 6 COM                           | Black/Shield     |
| Channel 6 POWER                         | Red              |
| Channel 6 ID                            | Green            |
| Channel 7 SIG                           | White (BP)       |
| Channel 1-3 SIG                         | Brown (RH)       |

### Notes:

- BX-592 is always connected to channel 6 when used for flow control with a APDA-371.
- BX-592 or BX-596 is required for actual flow control.
- BX-596 is required for PM<sub>2.5</sub> monitoring, effective March 2007.
- BX-597 RH signal can be connected to any unused met channel, typically 1,2 or 3. It must be manually scaled.

### Mounting:

The 500 series sensors typically mount near the top of the APDA-371 inlet tube with a short cross-arm and related hardware. The sensors may also be mounted to a nearby tripod, such as HORIBA model 905.

## 11 THEORY OF OPERATION and MATHEMATICAL ANALYSIS

When the high-energy electrons emanating from the radioactive decay of  $^{14}\text{C}$  (carbon-14) interact with nearby matter they lose their energy and, in some cases, are absorbed by the matter. These high-energy electrons emitted through radioactive decay are known as beta rays and the process is known as beta-ray attenuation. When matter is placed between the radioactive  $^{14}\text{C}$  source and a device designed to detect beta rays, the beta rays are absorbed and/or their energy diminished. This results in a reduction in the number of beta particles detected. The magnitude of the reduction in detected beta particles is a function of the mass of the absorbing matter between the  $^{14}\text{C}$  beta source and the detector.

The number of beta particles passing through absorbing matter, such as dust deposited on a filter tape, decrease nearly exponentially with the mass through which they must pass. Equation 1 shows this relationship.

### Equation 1

$$I = I_0 e^{-\mu x}$$

In Equation 1,  $I$  is the measured beta ray intensity (counts per unit time), of the attenuated beta ray (dust laden filter tape),  $I_0$  is the measured beta ray intensity of the un-attenuated beta ray (clean filter tape),  $\mu$  is the absorption cross section of the material absorbing the beta rays ( $\text{cm}^2/\text{g}$ ), and  $x$  is the mass density of the absorbing matter ( $\text{g}/\text{cm}^2$ ).

Equation 1 very closely resembles the Lambert-Beers Law, which is used in spectrometric analysis. Just as the Lambert-Beers Law is an idealization of what is actually observed, Equation 1 is also an idealized simplification of the true processes occurring meant to simplify the corresponding mathematics. However, experimental measurement shows that in properly designed monitors, such as the APDA-371, the use of this equation introduces no substantial error.

Equation 1 may be rearranged to solve for  $x$ , the mass density of the absorbing matter. This is shown in Equation 2.

### Equation 2

$$-\frac{1}{\mu} \ln \left[ \frac{I}{I_0} \right] = \frac{1}{\mu} \ln \left[ \frac{I_0}{I} \right] = x$$

In practice, the absorption cross section is experimentally determined during the calibration process. Once  $I$  and  $I_0$  are experimentally measured, it is a simple matter to calculate  $x$ , the predicted mass density.

In practice, ambient air is sampled at a constant flow rate ( $Q$ ) for a specified time  $\Delta t$ . This sampled air is passed through a filter of surface area  $A$ . Once  $x$ , the mass density of collected particles, has been determined, it is possible to calculate the ambient concentration of particulate matter ( $\mu\text{g}/\text{m}^3$ ) with Equation 3.

### Equation 3

$$c \left( \frac{\mu\text{g}}{\text{m}^3} \right) = \frac{10^6 A (\text{cm}^2)}{Q \left( \frac{\text{liter}}{\text{min}} \right) \Delta t (\text{min}) \mu \left( \frac{\text{cm}^2}{\text{g}} \right)}$$

In Equation 3,  $c$  is the ambient particulate concentration ( $\mu\text{g}/\text{m}^3$ ),  $A$  is the cross sectional area on the tape over which dust is being deposited ( $\text{cm}^2$ ),  $Q$  is the rate at which particulate matter is being collected on the filter tape (liters/minute), and  $\Delta t$  is the sampling time (minutes). Combining these equations yields to the final expression for the ambient particulate concentration in terms of measured quantities. This is shown in Equation 4.

### Equation 4

$$c \left( \frac{\mu\text{g}}{\text{m}^3} \right) = \frac{10^6 A (\text{cm}^2)}{Q \left( \frac{\text{liter}}{\text{min}} \right) \Delta t (\text{min}) \mu \left( \frac{\text{cm}^2}{\text{g}} \right)} \ln \left( \frac{I_0}{I} \right)$$

The key to the success of the beta attenuation monitor is due in part to the fact that  $\mu$ , the absorption cross-section, is almost insensitive to the nature of the matter being measured. This makes the APDA-371 very insensitive to the chemical composition of the material being collected.

It is instructive to perform a conventional propagation of errors analysis on Equation 4. Doing so, one can develop an equation for the relative measurement error ( $\sigma_c/c$ ) as a function of the uncertainty in each of the parameters comprising Equation 4. This leads to Equation 5.

#### Equation 5

$$\frac{\sigma_c}{c} = \sqrt{\frac{\sigma_A^2}{A^2} + \frac{\sigma_Q^2}{Q^2} + \frac{\sigma_t^2}{t^2} + \frac{\sigma_\mu^2}{\mu^2} + \frac{\sigma_I^2}{I^2 \ln\left[\frac{I}{I_0}\right]^2} + \frac{\sigma_{I_0}^2}{I_0^2 \ln\left[\frac{I}{I_0}\right]^2}}$$

Inspection of Equation 5 reveals several things. The relative uncertainty of the measurement ( $\sigma_c/c$ ) is decreased (improved) by increasing the cross sectional area of the filter tape (A), the flow rate (Q), the sampling time (t), the absorption cross-section ( $\mu$ ), I and  $I_0$ .

In practice, the uncertainty associated with the filter area ( $\sigma_A/A$ ), may be minimized by ensuring that the tape is in exactly the same position during the  $I_0$  measurement as in the I measurement phase. Careful design of the shuttle and tape control mechanisms inside of the APDA-371 results in minimal error here.

The uncertainty in the flow rate ( $\sigma_Q/Q$ ) may be minimized by properly controlling the flow of the instrument. For APDA-371 units with a manual flow valve, this value is on the order of  $\pm 3\%$ . For APDA-371 units equipped with the mass flow controller device, ( $\sigma_Q/Q$ ) decreases to  $\pm 1\%$ .

The relative error due to the uncertainty in the absorption cross section ( $\sigma_\mu/\mu$ ), is due to its slight variation as a function of the chemical composition of the matter being monitored. Generally, this relative error is on the order of  $\pm 2-3\%$ , with judicious selection of the calibrated value of  $\mu$ .

The uncertainty associated with the measurement of I and  $I_0$  has to do with the physical nature of the process leading to the emission of beta particles from the decay of  $^{14}\text{C}$ . This process follows Poisson statistics. Poisson statistics show the uncertainty in the measurement of I ( $\sigma_I/I$ ) and  $I_0$  ( $\sigma_{I_0}/I_0$ ) are minimized by increasing the sampling time. Mathematical analysis shows that doubling the sampling time and hence the measured intensity of I or  $I_0$  will reduce the uncertainty of the measurement by a factor of 1.41 (square root of 2).

#### 11.1 Conditions

#### Converting Data Between EPA Standard and Actual

As described in this manual, the APDA-371 can obtain concentration data using either actual or standard values for ambient temperature and pressure. In some cases, it is necessary to convert past concentration data collected in standard conditions to actual conditions, or the other way around. Note: temperature is in degrees Kelvin ( $^{\circ}\text{C}+273$ ) and pressure is in mmHg.

#### Equation 6

$$C_{\text{std}} = C_{\text{amb}} * (P_{\text{std}} / P_{\text{amb}}) * (T_{\text{amb}} / T_{\text{std}})$$

Equation 6 can be used to calculate the standard concentration ( $C_{\text{std}}$ ) from the ambient concentration ( $C_{\text{amb}}$ ) data using ambient barometric pressure and temperature data ( $P_{\text{amb}}$  and  $T_{\text{amb}}$ ) from the same time period in which the ambient concentration was recorded.  $P_{\text{std}}$  and  $T_{\text{std}}$  are the values of standard barometric pressure and standard ambient temperature. These values are usually the EPA mandated 760 mmHg and 298 degrees Kelvin (25  $^{\circ}\text{C}$ ). **Note:** Some other countries use different values for standard temperature and pressure.

## Equation 7

$$C_{\text{amb}} = C_{\text{std}} * (P_{\text{amb}} / P_{\text{std}}) * (T_{\text{std}} / T_{\text{amb}})$$

Equation 7 can be used to calculate the ambient concentration ( $C_{\text{amb}}$ ) from the standard concentration ( $C_{\text{std}}$ ) data using the ambient temperature and pressure. It is necessary to have access to valid data for the ambient temperature and pressure for the desired sample hour in order to be able to make the calculations.

**Example:** You have a data value of 27 $\mu\text{g}$  from a APDA which was configured to report data in EPA Standard conditions (298 K and 760 mmHg), but you need to know what the concentration would have been in actual conditions. The actual average temperature for the hour in question was 303 K and the average pressure was 720 mmHg.

$$\begin{aligned} C_{\text{amb}} &= C_{\text{std}} * (P_{\text{amb}} / P_{\text{std}}) * (T_{\text{std}} / T_{\text{amb}}) \\ C_{\text{amb}} &= 27 * (720/760) * (298/303) \\ C_{\text{amb}} &= 27 * 0.9474 * 0.9835 \\ \mathbf{C_{\text{amb}} = 25.1 \mu\text{g}} \end{aligned}$$

**APDA-371 Audit Sheet**

Model:

Serial Number:

Audit Date:

Audited By: \_\_\_\_\_

| Flow Audits                               |        |            |                   |
|---|--------|------------|-------------------|
| <b>Flow Reference Standard Used:</b>      | Model: | Serial No: | Calibration Date: |
| <b>Temperature Standard Used:</b>         | Model: | Serial No: | Calibration Date: |
| <b>Barometric Pressure Standard Used:</b> | Model: | Serial No: | Calibration Date: |

Leak Check Value: as found:  as left:

|                                | as found: | APDA | Ref. Std. | as left: | APDA | Ref. Std. |                              |
|--------------------------------|-----------|------|-----------|----------|------|-----------|------------------------------|
| Ambient Temperature:           | as found: | C    | C         | as left: | C    | C         | N/A <input type="checkbox"/> |
| Barometric Pressure:           | as found: | mmHg | mmHg      | as left: | mmHg | mmHg      |                              |
| Flow Rate (Actual Volumetric): | as found: | lpm  | lpm       | as left: | lpm  | lpm       | N/A <input type="checkbox"/> |
| Flow Rate (EPA Standard):      | as found: | lpm  | lpm       | as left: | lpm  | lpm       | N/A <input type="checkbox"/> |

**Mechanical Audits**

|                                |          |                          |         |                          |                                   |          |                          |         |                          |     |                          |
|--------------------------------|----------|--------------------------|---------|--------------------------|-----------------------------------|----------|--------------------------|---------|--------------------------|-----|--------------------------|
| Pump muffler unclogged:        | as found | <input type="checkbox"/> | as left | <input type="checkbox"/> | PM10 particle trap clean:         | as found | <input type="checkbox"/> | as left | <input type="checkbox"/> | N/A | <input type="checkbox"/> |
| Sample nozzle clean:           | as found | <input type="checkbox"/> | as left | <input type="checkbox"/> | PM10 drip jar empty:              | as found | <input type="checkbox"/> | as left | <input type="checkbox"/> | N/A | <input type="checkbox"/> |
| Tape support vane clean:       | as found | <input type="checkbox"/> | as left | <input type="checkbox"/> | PM10 bug screen clear:            | as found | <input type="checkbox"/> | as left | <input type="checkbox"/> | N/A | <input type="checkbox"/> |
| Capstan shaft clean:           | as found | <input type="checkbox"/> | as left | <input type="checkbox"/> | PM2.5 particle trap clean:        | as found | <input type="checkbox"/> | as left | <input type="checkbox"/> | N/A | <input type="checkbox"/> |
| Rubber pinch rollers clean:    | as found | <input type="checkbox"/> | as left | <input type="checkbox"/> | Inlet tube water-tight seal OK:   | as found | <input type="checkbox"/> | as left | <input type="checkbox"/> |     |                          |
| Chassis ground wire installed: | as found | <input type="checkbox"/> | as left | <input type="checkbox"/> | Inlet tube perpendicular to APDA: | as found | <input type="checkbox"/> | as left | <input type="checkbox"/> |     |                          |

| Analog Voltage Output Audit |      |                     |                      | N/A | <input type="checkbox"/> |
|-----------------------------|------|---------------------|----------------------|-----|--------------------------|
| DAC Screen                  | Test | APDA Voltage Output | Logger Voltage Input |     |                          |
| 0.000 Volts                 |      | Volts               | Volts                |     |                          |
| 0.500 Volts                 |      | Volts               | Volts                |     |                          |
| 1.000 Volts                 |      | Volts               | Volts                |     |                          |

| Membrane Audit   |   |
|------------------|---|
| LAST (mg):       | m |
| ABS (mg):        |   |
| Difference (mg): |   |
| % Difference:    |   |

| Flow Control Range |           |
|--------------------|-----------|
| Flow Setpoint      | APDA Flow |
| 15.0 LPM           |           |
| 16.7 LPM           |           |
| 18.3 LPM           |           |

| Setup and Calibration Values |          |       |           |          |       |           |          |       |
|------------------------------|----------|-------|-----------|----------|-------|-----------|----------|-------|
| Parameter                    | Expected | Found | Parameter | Expected | Found | Parameter | Expected | Found |
|                              | d        |       |           |          |       |           | d        | d     |

|                 |  |  |           |  |  |                  |  |  |
|-----------------|--|--|-----------|--|--|------------------|--|--|
| Clock Time/Date |  |  | FLOW TYPE |  |  | AP               |  |  |
| RS232           |  |  | Cv        |  |  | FRI              |  |  |
| STATION #       |  |  | Qo        |  |  | FRh              |  |  |
| RANGE           |  |  | ABS       |  |  | Password         |  |  |
| APDA SAMPLE     |  |  | μ sw      |  |  | Cycle Mode       |  |  |
| MET SAMPLE      |  |  | K Factor  |  |  | RH Control       |  |  |
| OFFSET          |  |  | BKGD      |  |  | RH Setpoint      |  |  |
| CONC UNITS      |  |  | STD TEMP  |  |  | Datalog RH       |  |  |
| COUNT TIME      |  |  | HEATER    |  |  | Delta-T Control  |  |  |
| FLOW RATE       |  |  | e1        |  |  | Delta-T Setpoint |  |  |
| CONC TYPE       |  |  | Errors    |  |  | Datalog Delta-T  |  |  |

|  |  |  |  |  |  |
|--|--|--|--|--|--|
| <b>Last 6 Errors in APDA-371 Error Log</b> |  |  |  |  |  |
|--|--|--|--|--|--|

| Error | Date | Time | Error | Date | Time |
|-------|------|------|-------|------|------|
| 1     |      |      | 4     |      |      |
| 2     |      |      | 5     |      |      |
| 3     |      |      | 6     |      |      |

**Audit Notes:**

---



---



---



---



## **Appendix 3**

### **Manual**



# **BX-596 AT/BP SENSOR MANUAL**



**Met One Instruments, Inc**  
1600 Washington Blvd.  
Grants Pass, Oregon 97526  
Telephone 541-471-7111  
Facsimile 541-541-7116

**BX-596 Sensor Manual** - © Copyright 2007 Met One Instruments, Inc. All Rights Reserved worldwide. No part of this publication may be reproduced, transmitted, transcribed, stored in a retrieval system, or translated into any other language in any form without the express written permission of Met One Instruments, Inc.

## About this Manual:

The BX-596 is an optional combination ambient temperature and barometric pressure sensor for use with the BAM-1020 particulate monitor. The BX-596 sensor is a required accessory for all BAM-1020 configured to sample PM<sub>2.5</sub> levels, effective March 2007. The sensor provides ambient temperature and pressure data to the unit for actual (volumetric) flow control and flow statistics during the hourly sample cycle. The BX-596 is only compatible with BAM-1020 firmware version 3.2.4 or later. This manual describes the installation and operation of the BX-596 sensor. Refer to the BAM-1020 operation manual as needed.

The BX-596-1 is an extended range version for extreme cold or high altitude environments.



**BX-596 Temperature/Pressure Sensor Installed on a BAM-1020 Inlet Tube**

## Specifications:

| <b>BX-596</b>          | <b>Barometric Pressure</b> | <b>Ambient Temperature</b> |
|------------------------|----------------------------|----------------------------|
| <b>Voltage Output:</b> | 0 to 2.5 volts             | 0 to 2.5 volts             |
| <b>Range:</b>          | 525 to 825 mmHg            | -40 to +55 deg C           |
| <b>Accuracy:</b>       | ±0.25 mmHg @ 25 C          | ± 1.5C above -30           |
| <b>ID Voltage:</b>     | 3.50 volts DC ± .02        |                            |

| <b>BX-596-1</b>        | <b>Barometric Pressure</b> | <b>Ambient Temperature</b> |
|------------------------|----------------------------|----------------------------|
| <b>Voltage Output:</b> | 0 to 2.5 volts             | 0 to 2.5 volts             |
| <b>Range:</b>          | 400 to 825 mmHg            | -50 to +50 deg C           |
| <b>Accuracy:</b>       | ±1.5 mmHg                  | ± 1.5C full scale          |
| <b>ID Voltage:</b>     | 4.10 volts DC ± .02        |                            |

## Installation and Setup:

Ensure that the BAM-1020 is sited and installed properly per the instructions in the operation manual.

During the installation process, you will need to provide an access point for the BX-596 sensor cable to enter the shelter where the BAM-1020 is installed. In some cases it is easiest to simply drill a 3/8" hole through the roof of the shelter about six inches away from the inlet tube, then feed the cable through the hole and caulk around it to prevent leaks.

There may be a better place to feed the cable into the shelter in some applications. The BX-902/903 environmental shelters supplied by Met One have pre-formed access holes in the side to allow the sensor cable to be routed to the BAM-1020. Decide the best way to route the cable into the shelter. The BX-596 comes with a standard 25-foot sensor cable. Longer cables may be ordered if required.

Remove the PM<sub>10</sub> head and PM<sub>2.5</sub> cyclone from the top of the BAM inlet tube. Attach the BX-596 to the inlet tube (about 8 to 18 inches from the top) with the supplied U-bolt hardware. Make sure that the sensor is level and tighten the U-bolt securely.

Make sure the BAM-1020 is turned off, then attach the sensor cable to the connector on the bottom of the BX-596. Route the loose end of the cable into the shelter and to the back of the BAM-1020. Coil up any excess length of cable. Attach the cable to the back of the BAM as shown in the following table.

| BX-596 AT/BP Sensor Connections |                      |                 |
|---------------------------------|----------------------|-----------------|
| Wire Color                      | Function             | BAM Terminal    |
| Yellow                          | AT Signal Output     | Channel 6 SIG   |
| Black/Shield                    | Ground               | Channel 6 COM   |
| Red                             | +12 VDC              | Channel 6 POWER |
| Green                           | Auto ID Signal 3.50V | Channel 6 ID    |
| White                           | BP Signal Output     | Channel 7 SIG   |

Reinstall the PM<sub>10</sub> head and PM<sub>2.5</sub> cyclone and seal around the cable hole with silicone if required.

## Operation:

When the BAM-1020 is powered up with a BX-596 installed, the unit will automatically sense the ID voltage from the sensor and configure input channels six and seven to read and scale the outputs from the sensor. **Note:** The BX-596 sensor requires BAM-1020 firmware revision 3.2.0 or later. The BX-596-1 extended range version requires BAM-1020 firmware revision 3.6.2 or later. If the BAM firmware is not current enough, then the BAM will not automatically identify and scale the sensor.

Turn ON the BAM-1020 and perform a calibration of the BX-596. Note: The calibration is performed in the TEST > FLOW screen which *will not be available* unless the FLOW TYPE is set to ACTUAL in the SETUP > CALIBRATE screen. You will need a reference standard measurement for ambient temperature and barometric pressure.

| MULTIPOINT FLOW CALIBRATION |         |         |          |
|-----------------------------|---------|---------|----------|
|                             | TARGET  | BAM     | STD      |
| <CAL>                       | AT:     | 23.8    | 23.8 C   |
|                             | BP:     | 760     | 760 mmHg |
|                             | FLOW 1: | 15.0    | 15.0 LPM |
|                             | FLOW 2: | 18.3    | 18.3 LPM |
|                             | FLOW 3: | 16.7    | 16.7 LPM |
| CAL                         | NEXT    | DEFAULT | EXIT     |

1. Enter the TEST > FLOW menu as shown above. The nozzle will lower automatically when this screen is entered. The “BAM” column is what the BAM-1020 measures for each parameter, and the “STD” column is where you will enter the correct values from your reference standard. The <CAL> symbol will appear next to the parameter selected for calibration.
2. Measure the ambient temperature with your reference standard positioned near the BX-596 sensor. Enter the value from your reference standard into the STD field using the arrow keys. Press the CAL hot key to correct the BAM reading. The BAM and STD values should now be the same.
3. Press the NEXT hot key to move the <CAL> indicator to the BP field, and repeat the same steps for barometric pressure.

The DEFAULT hot key can be pressed to reset the user calibration from the selected parameter and replace it with a factory setting. The DEFAULT calibration should be fairly close in most cases.

The BX-596 sensor is almost always calibrated as part of a BAM-1020 flow calibration. Always calibrate the AT and BP channels before calibrating the flow channels, as the flow rate is affected by the temperature and pressure of the ambient air.

The BX-596 temperature output may also be checked in an ice bath. The ice bath test is usually never done except in some cold weather environments. First calibrate the sensor at ambient temperature, then use the following steps:

1. Remove the stop screw from the bottom of the mounting bracket so that the electronics module is free to rotate. Rotate the module counter-clockwise until it disengages from the keyhole slots and comes free from the radiation shield.
2. The sensor comes with an 18 inch long ice bath extension harness. This may be used to allow the temperature bead to reach the ice bath if necessary. Carefully unplug the black temperature bead assembly from the top of the electronics module and install the harness between the bead and the module.
3. Insert the temperature bead into the ice water bath along with your reference sensor. Avoid immersing the bead assembly past the connector.

4. Allow the bead to equilibrate, then compare the AT reading in the TEST > FLOW screen to your reference sensor. The readings should match within  $\pm 1.5$  degrees C for the BX-596-1 extended range sensor. **Note:** The tolerance for the regular BX-596 standard range sensor is  $\pm 2.5$  C in temperatures below -30C.
5. Remove the ice bath harness and reassemble the sensor.

During operation of the BAM-1020, the output from the BX-596 can be viewed from the main flow statistics screen or the OPERATE screens. See the BAM-1020 manual.



**Ice Bath Extension Harness**

## **Maintenance:**

The BX-596 is designed to be low-maintenance, easy to access, and resistant to harsh environments. There are only a few maintenance items for the sensor besides routine calibration checks.

- Remove the bottom cover and make sure that the four holes in the cover plate are clear and have not been obstructed by insects or debris. These holes allow the air pressure to equilibrate inside the sensor for the barometric pressure reading. Clean the inside of the electronics enclosure every 12 months or as needed.
- Clean the radiation shield assembly at least once per year. Dirty shields reflect away solar radiation less efficiently.
- The circuit board is not intended to be removed or serviced by the customer.
- The black temperature bead assembly may be replaced if the bead becomes damaged. The assembly simply plugs into the top of the electronics module. The sensor will need to be recalibrated any time the temperature bead is replaced.

## **Technical Support:**

Should you still require support after consulting your printed documentation, we encourage you to contact one of our expert Technical Service representatives during normal business hours of 7:00 a.m. to 4:00 p.m. Pacific Standard Time, Monday through Friday. In addition, technical information and service bulletins are often posted on our website. Please contact us and obtain a Return Authorization (RA) number before sending any equipment back to the factory. This allows us to track and schedule service work and expedite customer service.

Phone: (541) 471-7111

Fax: (541) 471-7116

E-Mail: [service@metone.com](mailto:service@metone.com)

Web: [www.metone.com](http://www.metone.com)

Mail: Technical Services Department  
Met One Instruments, Inc.  
1600 NW Washington Blvd.  
Grants Pass, OR 97526