

**TÜV RHEINLAND  
ENERGIE UND UMWELT GMBH**



Report on the suitability test of the ambient air quality measuring system Model 5014i Beta with PM<sub>2.5</sub> pre-separator of the company Thermo Fisher Scientific for the component suspended particulate matter PM<sub>2.5</sub>

TÜV-Report: 936/21209885/H  
Cologne, 20 September 2013

[www.umwelt-tuv.de](http://www.umwelt-tuv.de)



[teu-service@de.tuv.com](mailto:teu-service@de.tuv.com)

**The department of Environmental Protection of TÜV Rheinland Energie und Umwelt GmbH**  
is accredited for the following work areas:

- Determination of air quality and emissions of air pollution and odour substances;
- Inspection of correct installation, function and calibration of continuously operating emission measuring instruments, including data evaluation and remote emission monitoring systems;
- Combustion chamber measurements;
- Performance testing of measuring systems for continuous monitoring of emissions and ambient air, and of electronic data evaluation and remote emission monitoring systems;
- Determination of stack height and air quality projections for hazardous and odour substances;
- Determination of noise and vibration emissions and pollution, determination of sound power levels and execution of sound measurements at wind energy plants

**according to EN ISO/IEC 17025.**

The accreditation is valid up to 22-01-2018. DAkkS-register number: D-PL-11120-02-00.

Reproduction of extracts from this test report is subject to written consent.

**TÜV Rheinland Energie und Umwelt GmbH**  
**D - 51105 Cologne, Am Grauen Stein, Tel: +49 221 806-5200, Fax: +49 221 806-1349**

## Acknowledgement

TÜV Rheinland Energie und Umwelt GmbH would like to acknowledge the involvement of Bureau Veritas and the National Physical Laboratory as our UK partners in this project for their involvement in collecting the UK field data; project management; and data processing.



Report on the suitability test of the ambient air quality measuring system  
Model 5014i Beta with PM<sub>2.5</sub> pre-separator of the company Thermo Fisher  
Scientific for the component suspended particulate matter PM<sub>2.5</sub>,  
Report No.: 936/21209885/H

Page 3 of 417



Report on the suitability test of the ambient air quality measuring system  
Model 5014i Beta with PM<sub>2.5</sub> pre-separator of the company Thermo Fisher  
Scientific for the component suspended particulate matter PM<sub>2.5</sub>

**Instrument tested:** Model 5014i Beta with PM<sub>2.5</sub> pre-separator

**Manufacturer:** Thermo Fisher Scientific  
27 Forge Parkway  
Franklin, Ma 02038  
USA

**Test period:** June 2009 to September 2013

**Date of report:** 20 September 2013

**Report number:** 936/21209885/H

**Editor:** Dipl.-Ing. Karsten Pletscher  
Tel.: +49 221 806-2592  
[karsten.pletscher@de.tuv.com](mailto:karsten.pletscher@de.tuv.com)

**Scope of report:**

Report:	170	Pages
Annex	Page 171	
Manual	Page 213	
Manual	Of 204	Pages
Total	417	Pages

**Blank page**



## Content

1.	SUMMARY AND PROPOSAL FOR DECLARATION OF SUITABILITY .....	13
1.1	Summary .....	13
1.2	Certification proposal .....	17
1.3	Summary of test results .....	18
2.	TASK DEFINITION.....	27
2.1	Nature of test .....	27
2.2	Objective.....	27
3.	DESCRIPTION OF THE AMS TESTED .....	28
3.1	Measuring principle.....	28
3.2	Functionality of the measuring system .....	29
3.3	AMS scope and set-up.....	32
3.4	Differences between Model 5014i Beta and Model 5030i SHARP .....	45
4.	TEST PROGRAMME .....	47
4.1	General.....	47
4.2	Laboratory test.....	51
4.3	Field test.....	52
5.	REFERENCE MEASURING METHODS .....	71
6.	TEST RESULTS .....	72
6.1	4.1.1 Measured value display .....	72
6.1	4.1.2 Easy maintenance .....	74
6.1	4.1.3 Functional check .....	76
6.1	4.1.4 Set-up times and warm-up times.....	78
6.1	4.1.5 Instrument design .....	80
6.1	4.1.6 Unintended adjustment .....	81



6.1	4.1.7 Data output .....	82
6.1	5.1 General.....	84
6.1	5.2.1 Certification ranges .....	85
6.1	5.2.2 Measuring range .....	86
6.1	5.2.3 Negative output signals.....	87
6.1	5.2.4 Failure in the mains voltage .....	88
6.1	5.2.5 Operating states.....	89
6.1	5.2.6 Switch-over .....	90
6.1	5.2.7 Maintenance interval .....	91
6.1	5.2.8 Availability .....	92
6.1	5.2.9 Instrument software .....	94
6.1	5.3.1 General .....	96
6.1	5.3.2 Repeatability standard deviation at zero point.....	98
6.1	5.3.3 Repeatability standard deviation at reference point.....	100
6.1	5.3.4 Linearity (lack of fit) .....	101
6.1	5.3.5 Sensitivity coefficient of sample gas pressure .....	102
6.1	5.3.6 Sensitivity coefficient of sample gas temperature.....	103
6.1	5.3.7 Sensitivity coefficient of surrounding temperature .....	104
6.1	5.3.8 Sensitivity coefficient of supply voltage .....	107
6.1	5.3.9 Cross-sensitivity.....	109
6.1	5.3.10 Averaging effect.....	110
6.1	5.3.11 Standard deviation from paired measurement.....	111
6.1	5.3.12 Long-term drift.....	113
6.1	5.3.13 Short-term drift.....	119
6.1	5.3.14 Response time .....	120
6.1	5.3.15 Difference between sample and calibration port.....	121
6.1	5.3.16 Converter efficiency .....	122

6.1	5.3.17 Increase of NO <sub>2</sub> concentration due to residence in the measuring system ...	123
6.1	5.3.18 Overall uncertainty .....	124
6.1	5.4.1 General.....	125
6.1	5.4.2 Equivalency of the sampling system .....	126
6.1	5.4.3 Reproducibility of the sampling systems .....	127
6.1	5.4.4 Calibration.....	128
6.1	5.4.5 Cross-sensitivity.....	130
6.1	5.4.6 Averaging effect.....	133
6.1	5.4.7 Constancy of sample volumetric flow .....	134
6.1	5.4.8 Tightness of the measuring system.....	138
6.1	Methodology of the equivalence check (modules 5.4.9 – 5.4.11) .....	140
6.1	5.4.9 Determination of uncertainty between systems under test $u_{bs}$ .....	141
6.1	5.4.10 Calculation of the expanded uncertainty of the instruments.....	148
6.1	5.4.11 Application of correction factors and terms.....	162
6.1	5.5 Requirements on multiple-component measuring systems .....	167
7.	RECOMMENDATIONS FOR PRACTICAL USE.....	168
8.	LITERATURE.....	170
9.	APPENDIX.....	171

## Tables

Table 1:	Description of the test sites .....	16
Table 2:	Description of the test site (additional campaign 2013) .....	16
Table 3:	Technical data for Model 5014i Beta (manufacturer's specifications) .....	43
Table 4:	Differences between Model 5014i Beta and Model 5030i SHARP, hardware.....	45
Table 5:	Overview of software versions during suitability testing.....	48
Table 6:	Field test sites.....	53
Table 7:	Ambient conditions at the field test sites, daily mean values .....	58
Table 8:	Evaluation of the Teddington (summer) campaign with rH adjusted to 50 % .....	59
Table 9:	Ambient conditions at the additional site "Bornheim, Summer 2013", shown as daily mean values .....	62
Table 10:	Results of the equivalence test at the site Bornheim, Summer 2013, SN 1 (58 %) & SN 2 (50 %), component PM <sub>2.5</sub> , raw data .....	63
Table 11:	Results of the equivalence test at the site Bornheim, summer 2013, SN 1 (58 %) & SN 2 (50 %), component PM <sub>2.5</sub> , slope correction 1.070 .....	63
Table 12:	Results of the equivalence test "suitability testing + Bornheim, summer 2013", SN 1 & SN 2, component PM <sub>2.5</sub> , slope correction 1.070.....	64
Table 13:	Results of Grubbs outlier test – Reference PM <sub>2.5</sub> .....	66
Table 14:	Discarded reference PM <sub>2.5</sub> paired values according to Grubbs.....	67
Table 15:	Used filter materials .....	70
Table 16:	Certification ranges .....	85
Table 17:	Determination of availability (without test-related outages).....	93
Table 18:	Determination of availability (including test-related outages) .....	93
Table 19:	Detection limit PM <sub>2.5</sub> .....	99
Table 20:	Dependence of the zero point (Beta) on surrounding temperature, deviation in µg/m <sup>3</sup> , average of three measurements.....	106
Table 21:	Dependence of sensitivity (mass coefficient) on surrounding temperature, deviation in %, average of three measurements.....	106
Table 22:	Dependence of the measured values on mains voltage, deviation in % .....	108
Table 23:	Concentration averages, standard deviation, uncertainty range and reproducibility in the field, measured component PM <sub>2.5</sub> .....	112
Table 24:	Zero point drift SN 1 & SN 2, test with zero filter.....	115
Table 25:	Sensitivity drift SN 1 & SN 2.....	117
Table 26:	Parameters of the calibration and analysis function, measured component PM <sub>2.5</sub> .....	128
Table 27:	Deviation between reference measurement and candidate on days with a relative humidity > 70 %, measured component PM <sub>2.5</sub> .....	131
Table 28:	Comparison candidate SN 1 with reference instrument, rel. humidity > 70 %, all test sites, measured component PM <sub>2.5</sub> .....	132
Table 29:	Comparison candidate SN 2 with reference instrument, rel. humidity > 70 %, all test sites, measured component PM <sub>2.5</sub> .....	132
Table 30:	Results of flow rate checks.....	135

Table 31:	Parameters for flow measurement (24-h average), SN 1 (field).....	136
Table 32:	Parameters for flow measurement (24-h average), SN 2 (field).....	136
Table 33:	Results of the tightness check.....	139
Table 34:	Uncertainty between systems under test $u_{bs}$ for candidates SN 1 and SN 2, measured component PM <sub>2.5</sub> .....	143
Table 35:	Overview equivalence test of Model 5014i Beta for PM <sub>2.5</sub> .....	151
Table 36:	Uncertainty between the reference devices $u_{ref}$ for PM <sub>2.5</sub> .....	153
Table 37:	Summary of the results of the equivalence test, SN 1 & SN 2, measured component PM <sub>2.5</sub> , raw data.....	154
Table 38:	Summary of the results of the equivalence check, SN 1 & SN 2, after slope correction.....	166
Table 39:	Stability of standard weight.....	207
Table 40:	Stability of the control filters.....	209
Table 41:	Conditioning and weighing timescales.....	210

## Figures

Figure 1:	Hardware components Model 5014i Beta – Beta module.....	29
Figure 2:	Diagram – Set-up of Model 5014i Beta .....	30
Figure 3:	Model 5014i Beta.....	32
Figure 4:	(European) PM <sub>2.5</sub> sampling inlet for Model 5014i Beta .....	33
Figure 5:	Heated sampling tube (DHS) .....	34
Figure 6:	Model 5014i Beta measuring system – here as Model 5030i SHARP after disassembly of the nephelometer module .....	34
Figure 7:	Model 5014i Beta measuring system (Systems 1 and 2 from right) at measuring station – here as Model 5030i SHARP with nephelometer module .....	35
Figure 8:	Vacuum pump (type: GAST Model 75R647, PN 110836-00) .....	35
Figure 9:	Main screen of the user interface .....	36
Figure 10:	Flow chart – Overview of menu-assisted firmware .....	39
Figure 11:	Zero filter for supplying air free of suspended particles and its connection adapter .....	40
Figure 12:	Set with foil holder and test foils.....	41
Figure 13:	Leak test adapter .....	42
Figure 14:	Course of PM <sub>2.5</sub> concentrations (reference) at the test site “Cologne, parking lot, winter“.....	54
Figure 15:	Course of PM <sub>2.5</sub> concentrations (reference) at the test site “Bornheim, motorway parking lot, summer” .....	54
Figure 16:	Course of PM <sub>2.5</sub> concentrations (reference) at the test site “Bornheim, motorway parking lot, winter“ .....	55
Figure 17:	Course of PM <sub>2.5</sub> concentrations (reference) at the test site “Teddington, summer“ .....	55
Figure 18:	Field test site Cologne, parking lot .....	56
Figure 19:	Field test site Bornheim, motorway parking lot.....	56
Figure 20:	Field test site Teddington .....	57
Figure 21:	Comparison of reference and candidate SN 1, measured component PM <sub>2.5</sub> , Teddington (summer), relative humidity threshold adjusted to 50 % .....	60
Figure 22:	Comparison of reference and candidate SN 2, measured component PM <sub>2.5</sub> , Teddington (summer), relative humidity threshold adjusted to 50 % .....	60
Figure 23:	Grubbs test results for the PM <sub>2.5</sub> reference method, Cologne (winter) .....	67
Figure 24:	Grubbs test results for the PM <sub>2.5</sub> reference method, Bornheim (summer).....	68
Figure 25:	Grubbs test results for the PM <sub>2.5</sub> reference method, Bornheim (winter) .....	68
Figure 26:	Grubbs test results for the PM <sub>2.5</sub> reference method, Teddington (summer) .....	69
Figure 27:	Display of the measured concentration .....	73
Figure 28:	Rear view of Model 5014i Beta .....	83
Figure 29:	Software version (here V02.00.00.232+) displayed by selection of the menu “Diagnostics / Program Versions” .....	95
Figure 30:	Zero point drift SN 1, measured component PM <sub>2.5</sub> .....	116

Figure 31:	Zero point drift SN 2, measured component PM <sub>2.5</sub> .....	116
Figure 32:	Drift of the measured value SN 1, measured component PM <sub>2.5</sub> .....	117
Figure 33:	Drift of the measured value SN 2, measured component PM <sub>2.5</sub> .....	118
Figure 34:	Flow of candidate SN 1 (field) .....	137
Figure 35:	Flow of candidate SN 2 (field) .....	137
Figure 36:	Results of the parallel measurements with the candidates SN 1 / SN 2, measured component PM <sub>2.5</sub> , all test sites .....	144
Figure 37:	Results of the parallel measurements with the candidates SN 1 / SN 2, measured component PM <sub>2.5</sub> , test site Cologne (winter) .....	144
Figure 38:	Results of the parallel measurements with the candidates SN 1 / SN 2, measured component PM <sub>2.5</sub> , test site Bornheim (summer).....	145
Figure 39:	Results of the parallel measurements with the candidates SN 1 / SN 2, measured component PM <sub>2.5</sub> , test site Bornheim (winter) .....	145
Figure 40:	Results of the parallel measurements with the candidates SN 1 / SN 2, measured component PM <sub>2.5</sub> , test site Teddington (summer) .....	146
Figure 41:	Results of the parallel measurements with the candidates SN 1 / SN 2, measured component PM <sub>2.5</sub> , all test sites, values ≥ 18 µg/m <sup>3</sup> .....	146
Figure 42:	Results of the parallel measurements with the candidates SN 1 / SN 2, measured component PM <sub>2.5</sub> , all test sites, values < 18 µg/m <sup>3</sup> .....	147
Figure 43:	Reference vs. candidate, SN 1 & SN 2, measured component PM <sub>2.5</sub> , all test sites .....	155
Figure 44:	Reference vs. candidate, SN 1, measured component PM <sub>2.5</sub> , all test sites .....	156
Figure 45:	Reference vs. candidate, SN 2, measured component PM <sub>2.5</sub> , all test sites .....	156
Figure 46:	Reference vs. candidate, SN 1, measured component PM <sub>2.5</sub> , Cologne (winter) .....	157
Figure 47:	Reference vs. candidate, SN 2, measured component PM <sub>2.5</sub> , Cologne (winter) .....	157
Figure 48:	Reference vs. candidate, SN 1, measured component PM <sub>2.5</sub> , Bornheim (summer) .....	158
Figure 49:	Reference vs. candidate, SN 2, measured component PM <sub>2.5</sub> , Bornheim (summer) .....	158
Figure 50:	Reference vs. candidate, SN 1, measured component PM <sub>2.5</sub> , Bornheim (winter).....	159
Figure 51:	Reference vs. candidate, SN 2, measured component PM <sub>2.5</sub> , Bornheim (winter).....	159
Figure 52:	Reference vs. candidate, SN 1, measured component PM <sub>2.5</sub> , Teddington (summer) .....	160
Figure 53:	Reference vs. candidate, SN 2, measured component PM <sub>2.5</sub> , Teddington (summer) .....	160
Figure 54:	Reference vs. candidate, SN 1, measured component PM <sub>2.5</sub> , values ≥ 18 µg/m <sup>3</sup> .....	161
Figure 55:	Reference vs. candidate, SN 2, measured component PM <sub>2.5</sub> , values ≥ 18 µg/m <sup>3</sup> .....	161
Figure 56:	Stability of standard weight .....	206
Figure 57:	Stability of the control filters .....	208
Figure 58:	Distribution for Emfab filters of (A) Pre spread weighed relative to the check weight and (B) Post spread weighed relative to the check weight. ....	213

Report on the suitability test of the ambient air quality measuring system  
Model 5014i Beta with PM<sub>2.5</sub> pre-separator of the company Thermo Fisher  
Scientific for the component suspended particulate matter PM<sub>2.5</sub>,  
Report No.: 936/21209885/H

**Blank page**



## 1. Summary and proposal for declaration of suitability

### 1.1 Summary

According to Directive 2008/50/EC of 21 May 2008 [7] on “Air quality and cleaner air for Europe” (replaces Council Directive 96/62/EC of 27 September 1996 on ambient air quality assessment and management including its daughter directives 1999/30/EC, 2000/69/EC, 2002/3/EC and the Council Decision 97/101/EC), the methods described in Standard EN 12341 “Air quality - Determination of the PM<sub>10</sub> fraction of suspended particulate matter. Reference method and field test procedure to demonstrate reference equivalence of measurement methods” and Standard EN 14907 “Ambient air quality - Standard gravimetric measurement method for the determination of the PM<sub>2.5</sub> mass fraction of suspended particulate matter” [3] serve as reference methods for suspended particle measurement of the respective mass fraction. However, EC member states are free to use any other method in the case of particulate matter for which the Member State concerned can demonstrate displays a consistent relationship to the reference method. In that event the results achieved by that method must be corrected to produce results equivalent to those that would have been achieved by using the reference method. (2008/50/EC, Annex VI, B).

The Guidance “Demonstration of Equivalence of Ambient Air Monitoring Methods” [4], which was developed by an ad hoc EC task group (Source:

<http://ec.europa.eu/environment/air/quality/legislation/pdf/equivalence.pdf>, Version January 2010) describes an equivalence check method for non-standard measurement methods.

The specifications of the Guide for the equivalence testing were included in the last revision of the VDI Standards VDI 4202, Part 1 [1] as well as VDI 4203, Part 3 [2].

The following limits were applied during suitability testing:

	PM <sub>2.5</sub>
Daily limit value (24 h)	not defined
Annual limit value (1 a)	25 µg/m <sup>3</sup> *

as well as for the calculations according to the Guide [4]

	PM <sub>2.5</sub>
Limit value	30 µg/m <sup>3</sup>

Standard VDI 4202, Part 1 of 2002 describes all “Performance criteria for performance tests of automated ambient air measuring systems”. General parameters for the related tests are given in Standard VDI 4203, Part 1 “Testing of automated measuring systems - General con-

cepts" of October 2001 and further specified in VDI 4203, Part 3 "Testing of automated measuring systems - Test procedures for point-related ambient air measuring systems for gaseous and particulate air pollutants" of August 2004.

Standard VDI 4202, Part 1 and VDI 4203, Part 3 were republished after an extensive revision with latest update September 2010. Unfortunately, after this revision uncertainties and contradictions remain regarding the concrete minimum requirements on the one hand, and the general relevance of the test points on the other hand when testing particulate ambient air measuring devices. The following test points require clarification:

- 6.1 5.3.2 Repeatability standard deviation at zero point  
no minimum requirement defined
- 6.1 5.3.3 Repeatability standard deviation at reference point  
not relevant for particulate devices
- 6.1 5.3.4 Linearity (lack of fit)  
not relevant for particulate devices
- 6.1 5.3.7 Sensitivity coefficient of surrounding temperature  
no minimum requirement defined
- 6.1 5.3.8 Sensitivity coefficient of supply voltage  
no minimum requirement defined
- 6.1 5.3.11 Standard deviation from paired measurement  
no minimum requirement defined
- 6.1 5.3.12 Long-term drift  
no minimum requirement defined
- 6.1 5.3.13 Short-term drift  
not relevant for particulate devices
- 6.1 5.3.18 Overall uncertainty  
not relevant for particulate devices, covered by 5.4.10

For this reason an official request to the competent German body was made, to define a coordinated procedure for dealing with inconsistencies in the Standard.

The following procedure was suggested:

Test points 5.3.2, 5.3.7, 5.3.8, 5.3.11 and 5.3.12 are evaluated as before basing on the minimum requirements stated in VDI 4202 Part 1 of 2002 (i.e. using the reference values B<sub>0</sub>, B<sub>1</sub> and B<sub>2</sub>).

The performance of the test points 5.3.3, 5.3.4, 5.3.13 and 5.3.18 is omitted, as they are not relevant for particulate measuring devices.

The competent German body agreed with the proposed procedure by decisions of 27 June 2011 and 07 October 2011.

Since according to the applied standards the reference values to be used are explicitly adjusted to component PM<sub>10</sub>, for component PM<sub>2.5</sub> the following reference values have been agreed upon:

	PM <sub>2.5</sub>	PM <sub>10</sub> (for comparison)
B <sub>0</sub>	2 µg/m <sup>3</sup>	2 µg/m <sup>3</sup>
B <sub>1</sub>	25 µg/m <sup>3</sup>	40 µg/m <sup>3</sup>
B <sub>2</sub>	200 µg/m <sup>3</sup>	200 µg/m <sup>3</sup>

B<sub>1</sub> shall be merely adjusted to the level of the limit value for the annual average.

Thermo Fisher Scientific has commissioned TÜV Rheinland Energie und Umwelt GmbH to perform of a suitability test of Model 5014i Beta measuring system for component suspended particulate matter PM<sub>2.5</sub>.

- Standard VDI 4202 Part 1, "Performance criteria for performance tests of automated ambient air measuring systems – Point-related measurement methods for gaseous and particulate air pollutants", September 2010 or June 2002 [1]
- Standard VDI 4203 Part 3, "Testing of automated measuring systems - Test procedures for point-related ambient air measuring systems for gaseous and particulate air pollutants", September 2010 or August 2004 [2]
- Standard EN 14907, "Ambient air quality - Standard gravimetric measurement method for the determination of the PM<sub>2.5</sub> mass fraction of suspended particulate matter", German version EN 14907: 2005 [3]
- Guide "Demonstration of Equivalence of Ambient Air Monitoring Methods", English version of January 2010 [4]

The measuring system Model 5014i Beta determines particulate concentration using a radiometric method of measurement. With the aid of a pump, ambient air is sucked at 16.67 l/min via a PM<sub>2.5</sub> pre-separator. The dust-laden sampling air is then suctioned on a filter tape. The determination of particulate mass collected on the filter tape is performed continuously during sampling by means of the radiometric measuring principle of beta absorption.

The tests took place in the laboratory and for several months in the field.

The following test sites were chosen for the field test according to Table 1.

**Table 1:** Description of the test sites

	Cologne, parking lot, winter	Bornheim, motorway parking lot, summer	Bornheim, motorway parking lot, winter	Teddington (UK) summer
Period	03/2011 – 05/2011	07/2011 – 11/2011	01/2012 – 03/2012	07/2012 – 10/2012
No. of paired values: Candidates	52	91	49	50
Characteristics	Urban background	Rural structure + mo- torway	Rural structure + mo- torway	Urban background
Rank of pollution	Average to high	Low to average	Average	Average

To qualify the necessary change of the threshold for the relative humidity to control the sample heating from originally 50 % to 58 % (necessary due to the results of the campaign in Teddington UK), an additional campaign at one of the German sites with two candidate systems with settings of each 50 % and 58 % was performed (decision of the 32<sup>nd</sup> Expert Meeting "test reports" of May 14/15 2013). Table 2 gives an overview on the additional campaign. The results of this campaign are shown in chapter 4.3 Field test from page 52.

**Table 2:** Description of the test site (additional campaign 2013)

	Bornheim, motorway parking lot, summer
Period	06/2013 – 07/2013
No. of paired values: Candidates	45
Characteristics	Rural structure + motorway
Rank of pollution	Low to average

The complete test was performed within the scope of the test programme "Combined MCERTS and TÜV PM Equivalence Testing Programme". In the context of European harmonisation, the test programme was developed and carried out by British and German test institutes (Bureau Veritas UK & Ireland, National Physical Laboratory NPL and TÜV Rheinland). It comprises the testing of the latest series of suspended particle measuring systems by different manufacturers in the laboratory and at field test sites in the UK and in Germany.

The minimum requirements were fulfilled during suitability testing.

TÜV Rheinland Energie und Umwelt GmbH therefore suggests publication as a suitability-tested measuring system for continuous monitoring of suspended particulate matter PM<sub>2.5</sub> in ambient air.

## 1.2 Certification proposal

Due to the positive results achieved, the following recommendation is put forward for the notification of the AMS as a suitability-tested measuring system:

### AMS designation:

Model 5014i Beta with PM<sub>2.5</sub> pre-separator for suspended particulate matter PM<sub>2.5</sub>

### Manufacturer:

Thermo Fisher Scientific, Franklin, USA

### Field of application:

Continuous monitoring of suspended particulate matter of the PM<sub>2.5</sub> fraction in ambient air (stationary operation)

### Measuring ranges during suitability test:

Component	Certification range	Unit
PM <sub>2.5</sub>	0 – 1000	µg/m <sup>3</sup>

### Software version:

V02.00.00.232+

### Restrictions:

None

### Notes:

1. The requirements according to guide "Demonstration of Equivalence of Ambient Air Monitoring Methods" are fulfilled for the measured component PM<sub>2.5</sub>.
2. The measuring system shall be operated within a lockable measuring cabinet.
3. The measuring system is to be calibrated on site at regular intervals by application of the gravimetric PM<sub>2.5</sub> reference method according to EN 14907.
4. It is recommended that the measuring system is operated with a threshold for the relative humidity of 58 %, in particular at sites with significantly high ratio of volatiles in the suspended particulate matter.
5. The test report on the suitability test is available online under [www.qal1.de](http://www.qal1.de).

### Test report:

TÜV Rheinland Energie und Umwelt GmbH, Cologne, Germany  
Report No.: 936/21209885/H of 20 September 2013

### 1.3 Summary of test results

Minimum requirement	Specification	Test result	Ful-filled	Page
4	Requirements on the instrument design			
4.1	General requirements			
4.1.1	Measured value display	Shall be available.	The measuring system is fitted with a measured value display.	yes 72
4.1.2	Easy maintenance	Necessary maintenance of the measuring systems should be possible without larger effort, if possible from outside.	Maintenance works can be carried out with commonly available tools taking reasonable time and effort.	yes 74
4.1.3	Functional check	If the operation or the functional check of the measuring system require particular instruments, they shall be considered as part of the measuring system and be applied in the corresponding sub-tests and included in the assessment.	All system functions listed in the manual are available, can be activated and function well. The current system status is continuously monitored and displayed by a series of status messages.	yes 77
4.1.4	Set-up times and warm-up times	Shall be specified in the instruction manual.	The set-up and warm-up times were determined.	yes 79
4.1.5	Instrument design	Shall be specified in the instruction manual.	The instrument design specifications listed in the operating manual are complete and correct.	yes 80
4.1.6	Unintended adjustment	It shall be possible to secure the adjustment of the measuring system against illicit or unintended adjustment during operation.	The AMS is protected against unauthorised and unintended adjustment. In addition, the AMS shall be locked up in a measuring cabinet.	yes 81
4.1.7	Data output	The output signals shall be provided digitally and/or as analogue signals	Measured signals are output as analogue signals (in V or mA) and digitally (via Ethernet, RS 232, RS 485).	yes 82
5.	Performance requirements			
5.1	General	The manufacturer's specifications in the instruction manual shall be by no means better than the results of the performance test.	No differences between the instrument design and the descriptions given in the manual were detected.	yes 84

Minimum requirement	Specification	Test result	Ful-filled	Page
5.2 General requirements on measuring systems				
5.2.1 Certification ranges	Have to comply with the requirements of Table 1 of the Standard VDI 4202 Part 1.	It is possible to assess the measuring system in the range of the relevant limit values.	yes	85
5.2.2 Measuring range	The upper limit of measurement of the measuring systems shall be greater or equal to the upper limit of the certification range.	A measuring range of 0 – 10 000 µg/m <sup>3</sup> is set by default. It is possible to adjust other measuring ranges. The upper limit of the measuring range of the measuring system is greater than the respective upper limit of the certification range.	yes	86
5.2.3 Negative output signals	Negative output signals or measured values may not be suppressed (life zero).	Negative measured signals are displayed directly on the AMS and are transmitted correctly via the respective signal outputs of the measuring system.	yes	87
5.2.4 Failure in the mains voltage	Uncontrolled emission of operation and calibration gas shall be avoided. The instrument parameters shall be secured by buffering against loss caused by failure in the mains voltage. When mains voltage returns, the instrument shall automatically reach the operation mode and start the measurement according to the operating instructions.	All instrument parameters are protected against loss through buffering. After the power supply has returned, the measuring device goes back to failure-free operational condition and resumes measurement. However, at least the first 12 h worth of data after voltage returns shall be discarded, since the system needs an equilibration phase after restart until the BETA detector adjusts to ambient conditions.	yes	88
5.2.5 Operating states	The measuring system shall allow the control of important operating states by telemetrically transmitted status signals.	The measuring systems can be extensively monitored and operated from an external PC via modem or router.	yes	89
5.2.6 Switch-over	Switch-over between measurement and functional check and/or calibration shall be possible telemetrically by computer control or manual intervention.	In principle, all necessary operations for performing a functional check can be monitored directly on the system or via telemetric remote control.	yes	90
5.2.7 Maintenance interval	If possible 3 months, minimum 2 weeks.	The maintenance interval is defined by the necessary maintenance procedures and has been set to 1 month.	yes	91

Minimum requirement	Specification	Test result	Ful-filled	Page
5.2.8 Availability	Minimum 95 %.	The availability was 97.4 % for SN 1 and 97.1 % for SN 2 without test-related outages, or 90.2 % for SN 1 and 90.0 % for SN 2 including test-related outages.	yes	92
5.2.9 Instrument software	The version of the instrument software to be tested shall be displayed during switch-on of the measuring system. The test institute shall be informed on changes in the instrument software, which have influence on the performance of the measuring system.	The version of the instrument software is shown on the display. Changes to the instrument software are communicated to the test institute.	yes	94
<b>5.3 Requirements on measuring systems for gaseous air pollutants</b>				
5.3.1 General	Minimum requirement according VDI 4202 Part 1.	The test is based on the minimum requirements of Standard VDI 4202, Part 1 (September 2010). Test points 5.3.2, 5.3.7, 5.3.8, 5.3.11 and 5.3.12 are evaluated as before basing on the minimum requirements stated in VDI 4202 Part 1 of 2002 (i.e. using the reference values B <sub>0</sub> , B <sub>1</sub> and B <sub>2</sub> ). The performance of the test points 5.3.3, 5.3.4, 5.3.13 and 5.3.18 is omitted, as they are not relevant for particulate measuring devices.	yes	96
5.3.2 Repeatability standard deviation at zero point	The repeatability standard deviation at zero point shall not exceed the requirements of Table 2 in the certification range according to Table 1 of Standard VDI 4202 Part 1 (September 2010). For PM: Max. B <sub>0</sub> .	The investigations result in detection limits of 1.77 µg/m <sup>3</sup> for system 1 (SN 1) and 2.25 µg/m <sup>3</sup> for system 2 (SN 2).	yes	98
5.3.3 Repeatability standard deviation at reference point	The repeatability standard deviation at reference point shall not exceed the requirements of Table 2 in the certification range according to Table 1 of Standard VDI 4202 Part 1 (September 2010).	Not applicable.	-	100
5.3.4 Linearity (lack of fit)	The analytical function describing the relationship between the output signal and the value of the air quality characteristic shall be linear.	For PM <sub>2.5</sub> particulate measuring systems, this test shall be performed according to minimum requirement 5.4.10 "Calculation of the expanded uncertainty of the instruments".	-	101



Minimum requirement	Specification	Test result	Ful-filled	Page
5.3.5 Sensitivity coefficient of sample gas pressure	The sensitivity coefficient of the sample gas pressure at reference point shall not exceed the specifications of Table 2 of Standard VDI 4202 Part 1 (September 2010).	Not applicable.	-	102
5.3.6 Sensitivity coefficient of sample gas temperature	The sensitivity coefficient of the sample gas temperature at reference point shall not exceed the specifications of Table 2 of Standard VDI 4202 Part 1 (September 2010).	Not applicable.	-	103
5.3.7 Sensitivity coefficient of surrounding temperature	The sensitivity coefficient of the surrounding temperature at zero and reference point shall not exceed the specifications of Table 2 of Standard VDI 4202 Part 1 (September 2010). For PM: Zero point value for $\Delta T_u$ of 15 K between +5 °C and +20 °C or 20 K between +20 °C and +40 °C shall not exceed $B_0$ . The measurement value in the range of $B_1$ shall not exceed $\pm 5\%$ for $\Delta T_u$ of 15 K between +5 °C and +20 °C or for 20 K between +20 °C and +40 °C.	The maximum dependence on surrounding temperature in the range 5 °C to 40 °C was -2.4 $\mu\text{g}/\text{m}^3$ at zero. No deviation > -2.6 % of the default value at 20 °C could be observed at reference point.	yes	104
5.3.8 Sensitivity coefficient of supply voltage	The sensitivity coefficient of the electric voltage at reference point shall not exceed the specifications made in Table 2 of Standard VDI 4202 Part 1 (September 2010). For PM: Change in measured value at $B_1$ maximum $B_0$ within the voltage interval (230 +15/-20) V.	No deviations > -1.4 % in relation to the default value at 230 V caused by voltage changes could be detected for PM <sub>2.5</sub> .	yes	107
5.3.9 Cross-sensitivity	The change in the measured value caused by interfering components in the sample gas shall not exceed the requirements of Table 2 of Standard VDI 4202 Part 1 (September 2010) at zero and reference point.	Not applicable.	-	109

Minimum requirement	Specification	Test result	Ful-filled	Page
5.3.10 Averaging effect	For gaseous components the measuring system shall allow the formation of hourly averages. The averaging effect shall not exceed the requirements of Table 2 of Standard VDI 4202 Part 1 (September 2010).	Not applicable.	-	110
5.3.11 Standard deviation from paired measurement	The standard deviation from parallel determinations shall be done with two identical measuring devices during field test. It shall not exceed the specifications stated in Table 2 of Standard VDI 4202 Part 1 (September 2010). For PM: RD ≥ 10 related to B <sub>1</sub> .	The reproducibility for PM <sub>2.5</sub> was 11 for the complete dataset of the field test.	yes	111
5.3.12 Long-term drift	The long-term drift at zero point and reference point shall not exceed the requirements of Table 2 in the field test of Standard VDI 4202 Part 1 (September 2010) in the field test. For PM: Zero point: within 24 h and within the maintenance interval a maximum of B <sub>0</sub> . As reference point: within 24 h and within the maintenance interval a maximum 5 % of B <sub>1</sub> .	The maximum deviation at zero point was -2.9 µg/m <sup>3</sup> in relation to the previous value and -2.6 µg/m <sup>3</sup> in relation to the start value. It should be noted that all absolute measured values lie within the permissible range of ± 2 µg/m <sup>3</sup> . All further deviations both from the previous value and from the start value are also within the permissible limits of B <sub>0</sub> = 2 µg/m <sup>3</sup> . The values obtained during the sensitivity drift tests amount to a maximum of -2.9 % in relation to the previous value for PM <sub>2.5</sub> .	yes	113
5.3.13 Short-term drift	The short-term drift at zero point and reference point shall not exceed the requirements of Table 2 of Standard VDI 4202 Part 1 (September 2010) within 12 h (for benzene 24 h) in the laboratory test and within 24 h in the field test.	Not applicable.	-	119

Minimum requirement	Specification	Test result	Ful-filled	Page
5.3.14 Response time	The response time (rise) of the measuring system shall not exceed 180 s. The response time (fall) of the measuring system shall not exceed 180 s. The difference between the response time (rise) and response time (fall) of the measuring system shall not exceed 10% of response time (rise) or 10 s, whatever value is larger.	Not applicable.	-	120
5.3.15 Difference between sample and calibration port	The difference between the measured values obtained by feeding gas at the sample and calibration port shall not exceed the requirements of Table 2 of Standard VDI 4202 Part 1 (September 2010).	Not applicable.	-	121
5.3.16 Converter efficiency	In the case of measuring systems with a converter, the efficiency of the converter shall be at least 98 %.	Not applicable.	-	122
5.3.17 Increase of NO <sub>2</sub> concentration due to residence in the measuring system	In case of NO <sub>x</sub> measuring systems, the increase of NO <sub>2</sub> concentration due to residence in the measuring system shall not exceed the requirements of Table 2 of Standard VDI 4202 Part 1 (September 2010).	Not applicable.	-	123
5.3.18 Overall uncertainty	The expanded uncertainty of the measuring system shall be determined. The value determined shall not exceed the corresponding data quality objectives in the applicable EU Directives on air quality listed in Annex A, Table A1 of Standard VDI 4202 Part 1 (September 2010).	By resolution of the competent German body (see module 5.3.1), this test is not relevant for particulate measuring systems. Reference is made to module 5.4.10.	-	124

Minimum requirement	Specification	Test result	Ful-filled	Page
<b>5.4 Requirements on measuring systems for particulate air pollutants</b>				
5.4.1 General	Test according to the minimum requirement stated in Table 5 of Standard VDI 4202, Part 1. Furthermore, the particle mass concentration shall be related to a defined volume.	Testing was carried out in compliance with the minimum requirements stated in Table 5 of Standard VDI 4202, Part 1 (September 2010). The calculated mass is related to a defined and actively regulated sampling volume, thus determining the particulate mass concentration.	yes	125
5.4.2 Equivalency of the sampling system	The equivalency to the reference method according to EN 12341 [T2] shall be demonstrated.	Not applicable to PM <sub>2.5</sub> sampling systems. Reference is made to module 5.4.10 of this report.	--	126
5.4.3 Reproducibility of the sampling systems	This shall be demonstrated in the field test for two identical systems according to EN 12341 [T2].	Not applicable to PM <sub>2.5</sub> sampling systems. Reference is made to module 5.4.9 of this report.	-	127
5.4.4 Calibration	The systems under test shall be calibrated in the field test by comparison measurements with the reference method according to EN 12341 and EN 14907. Here, the relationship between the output signal and the gravimetrically determined reference concentration shall be determined as a steady function.	A statistical correlation between the reference measuring method and the device reading could be demonstrated.	yes	128
5.4.5 Cross-sensitivity	Shall not exceed 10 % of the limit value	No deviation of the measured signal from the nominal value > 0.9 µg/m <sup>3</sup> caused by interference of moisture in the sample could be observed for PM <sub>2.5</sub> . No negative influence on the measured values at varying relative humidity was detected during the field test. Comparability of the candidates with the reference method according to Guide „Demonstration of Equivalence of Ambient Air Monitoring Methods” [4] is also given for days with a relative humidity > 70 %.	yes	130
5.4.6 Averaging effect	The measuring system shall allow for formation of 24 h averages. The time of the sum of all filter changes within 24 h may not exceed 1 % of this averaging time.	It is possible to form daily averages based on the three measurement cycles using the described instrument configuration and a cycle duration of 8 hours.	yes	133

Minimum requirement	Specification	Test result	Ful-filled	Page
5.4.7 Constancy of sample volumetric flow	± 3 % of the rated value. All instantaneous values of the sample volumetric flow shall be within a range of ± 5 % of the rated value during sampling.	All determined daily averages present deviations less than ±3 % from the nominal value; all instantaneous values deviate less than ±5 %.	yes	134
5.4.8 Tightness of the measuring system	Leakage shall not exceed 1 % of the sample volume sucked.	The criteria specified by the manufacturer upon which the tightness check is considered passed – maximum difference of ±0.42 l/min (= ±2.5 % of the flow rate) between the flow rates measured by the instrument and by the external flow meter under application of the adapter – proved to be appropriate parameters for monitoring the instrument's tightness. The laboratory tests resulted in a maximum leakage < 1 % of the nominal flow rate of 16.67 l/min for both candidates.  The tightness check must only be performed with the tightness check adapter and the described procedure. It can otherwise damage the instrument.	yes	138
5.4.9 Determination of uncertainty between systems under test	Shall be determined according to chapter 9.5.2.1 of the guidance document "Demonstration of Equivalence of Ambient Air Monitoring Methods" in the field test for at least two identical systems.	The uncertainty between the candidates $u_{bs}$ is with a maximum of 1.69 µg/m <sup>3</sup> for PM <sub>2.5</sub> below the required value of 2.5 µg/m <sup>3</sup> .	yes	141
5.4.10 Calculation of the expanded uncertainty of the instruments	Determination of the expanded uncertainty of the candidates according to chapter 9.5.2.2ff of the guidance document „Demonstration of Equivalence of Ambient Air Monitoring Methods“.	The determined uncertainties WCM without application of correction factors lay for all observed datasets below the defined expanded relative uncertainty $Wd_{q0}$ of 25 % for fine dust.	yes	148

Minimum requirement	Specification	Test result	Ful- filled	Page
5.4.11 Application of correction factors and terms	If the maximum expanded uncertainty of the systems under test exceeds the data quality objectives according to the European Directive on ambient air quality [7] for the test of PM <sub>2.5</sub> measuring systems, the application of correction factors and terms is allowed. Values corrected shall meet the requirements of chapter 9.5.2.2 ff. of the guidance document „Demonstration of Equivalence of Ambient Air Monitoring Methods“.	The candidate systems fulfil the requirements on data quality of ambient air quality measurements during the test even without application of correction factors. A correction of the slope leads nevertheless to a significant improvement of the expanded measuring uncertainty of the full data comparison.	yes	162
5.5 Requirements on multiple-component measuring systems	Shall comply with the requirements set for each component also in the case of simultaneous operation of all measuring channels.	Not applicable.	-	167

## **2. Task definition**

### **2.1 Nature of test**

Thermo Fisher Scientific has commissioned TÜV Rheinland Energie und Umwelt GmbH to carry out suitability testing of the measuring system Model 5014i Beta with PM<sub>2.5</sub> pre-separator. The test was performed as a complete suitability test.

### **2.2 Objective**

The AMS shall determine the content of PM<sub>2.5</sub> fine dust in ambient air within the concentration range of 0 - 1000 µg/m<sup>3</sup>.

The suitability test was carried out in accordance with the current standards for suitability tests while taking into account the latest developments.

The test was performed in consideration of the following standards:

- Standard VDI 4202 Part 1, "Performance criteria for performance tests of automated ambient air measuring systems – Point-related measurement methods for gaseous and particulate air pollutants", September 2010 or June 2002 [1]
- Standard VDI 4203 Part 3, "Testing of automated measuring systems – Test procedures for point-related ambient air measuring systems for gaseous and particulate air pollutants", September 2010 or August 2004 [2]
- Standard EN 14907, "Ambient air quality - Standard gravimetric measurement method for the determination of the PM<sub>2.5</sub> mass fraction of suspended particulate matter", German version EN 14907: 2005 [3]
- Guide "Demonstration of Equivalence of Ambient Air Monitoring Methods", English version of January 2010 [4]

### 3. Description of the AMS tested

#### 3.1 Measuring principle

The ambient air measuring system Model 5014i Beta operates under the principle of beta attenuation.

The principle of radiometric mass determination is based on the physics law of beta attenuation as effect of passing through a thin layer of matter.

This relation is described as follows:

$$C_{\beta} = \frac{A}{\mu_m Q t} \left( \ln \left[ \frac{f_o}{f_f} \right] \right)$$

where:

$C_{\beta}$	= particle mass concentration	$A$	= particle collection area (filter spot)
$\mu_m$	= mass attenuation coefficient (dependent on the energy of the beta source)		
$Q$	= sampling flow rate	$t$	= sampling time
$f_o$	= initial beta count rate (tare)	$f_f$	= final beta count rate

The radiometric mass determination is calibrated on site with help of null and span foils. In using the "mass transfer standard" foil set (= span foil set), the radiometric measurement can be checked anytime for quality assurance purposes and, if required, calibrated.

This principle is identical to the one used by the radiometric measurement module of the Model 5030i SHARP measuring system (see test report 936/21209885/F).

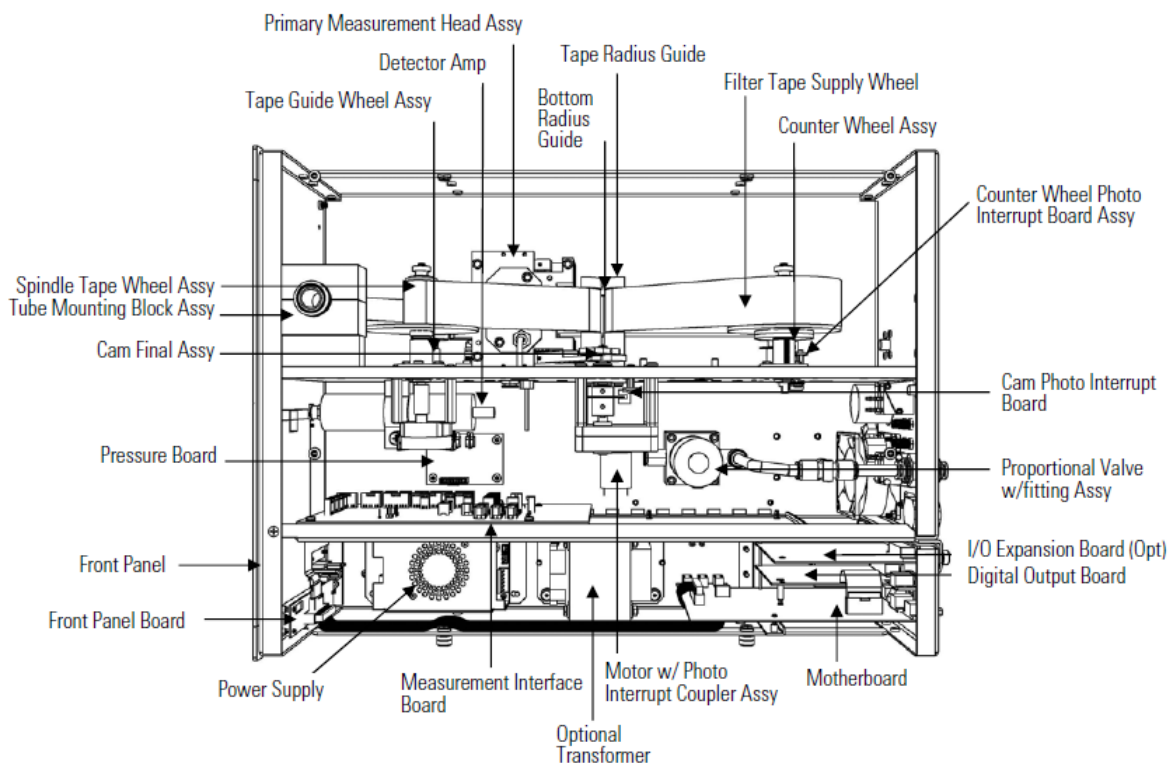


### 3.2 Functionality of the measuring system

The Model 5014i Beta measuring system is based on the principle of beta attenuation (analogous to Model 5030i SHARP, see test report 936/21209985/F).

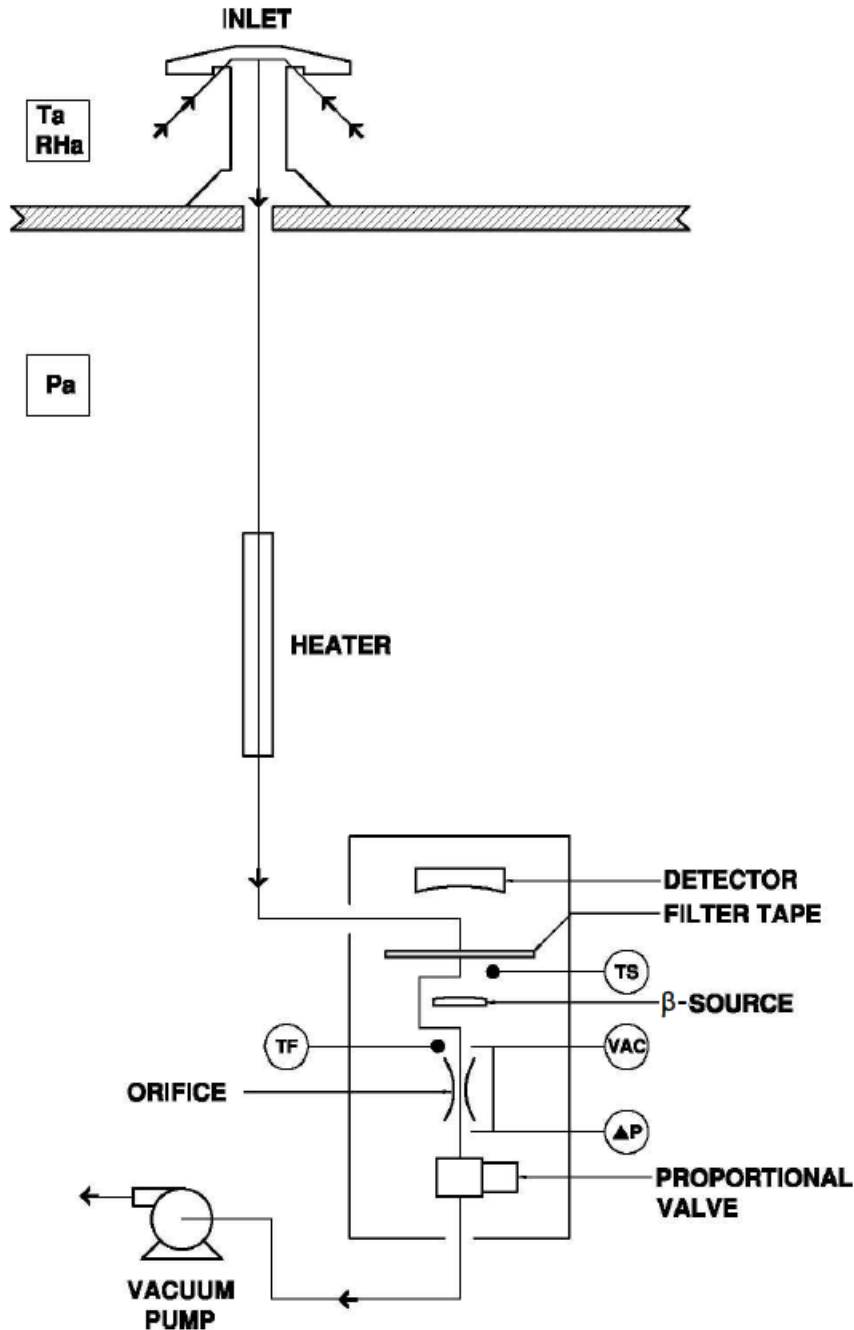
The particle sample passes through the PM<sub>2.5</sub> sampling inlet with a flow rate of 1 m<sup>3</sup>/h (=16.67 l/min) and reaches via the heated sampling tube (DHS = dynamic heating system) the actual Model 5014i Beta measuring instrument.

The use of the dynamic heating system DHS ensures that the relative humidity of the air passing through the filter tape of the radiometric stage stays well below the point at which the collected particles accrete and condensation effects that may distort the measured value appear. It also allows for maintaining the relative humidity below a specified threshold in the system (set value during suitability testing: 50 % and 58 % rel. humidity). This system minimises the internal temperature rise ensuring negligible loss of semi-volatiles from the collected sample when the ambient relative humidity is below the threshold to which the heater is controlling. As the ambient relative humidity increases above the threshold, the applied heating is optimised to maintain the relative humidity threshold above the beta attenuation filter tape of the radiometric stage. The regulation of the DHS is carried out using the control variable “relative sample humidity” rH (here: nominal value < 50 % / 58 %, see Section 4.3 Field test) and the filter temperature sensor (here: maximum value of 30 °C). The heating conditions can be adjusted subject to the requirements of the measurement network.



**Figure 1:** Hardware components Model 5014i Beta – Beta module

Figure 2 shows the path a particle sample travels within the Model 5014i Beta measuring system after passing the sampling inlet and sampling tube, including the DHS.



**Figure 2:** Diagram – Set-up of Model 5014i Beta

The enclosure of the Model 5014i measuring system is under the heated tube. The fine dust passes the sampling tube and reaches the radial tube above the radiometric assembly.

There, the particles are deposited on the glass fibre filter tape for radiometric measurement. The particles are collected on the filter tape up to a specified threshold (during test: fast-forward of filter tape after 8 h or when mass is >1500 µg on the filter tape or when the deviation of the current flow rate from the nominal flow rate is more than 2.5 %).

The filter tape can be found between the proportional detector and the 14C beta source. The beta ray is transmitted from the bottom upwards passing through the filter tape and the accumulated particle layer. The intensity of the beta ray is attenuated by the increasing mass load, thus reducing its intensity. The reduced beta intensity is then measured by the proportional detector. The mass on the filter tape is calculated from the continuous integrated count rate. The determined count rate is continuously corrected with regard to changes in the air density.

Furthermore, the radiometric mass determination is optimised by the simultaneous determination and consideration of the natural  $\alpha$  activity of aerosols. This additional  $\alpha$  count rate serves the purpose of measuring radon, which causes undesirable interference in the radiometric mass determination of particles and must therefore be compensated.

In order to keep the sampling flow rate at a constant nominal value, the continuous measurement of the flow rate as well as its adjustment is carried out by means of a proportional valve.

The PM concentrations are shown on the display on the front side of the measuring system as PM (= radiometrically measured values). The measured values can be obtained through different output paths (analogue, digital, Ethernet).

The set-up and functionality of the radiometric determination of PM concentrations of the Model 5014i Beta measuring system are identical to the radiometric measurement of Model 5030i SHARP (see test report 936/21209885/F)

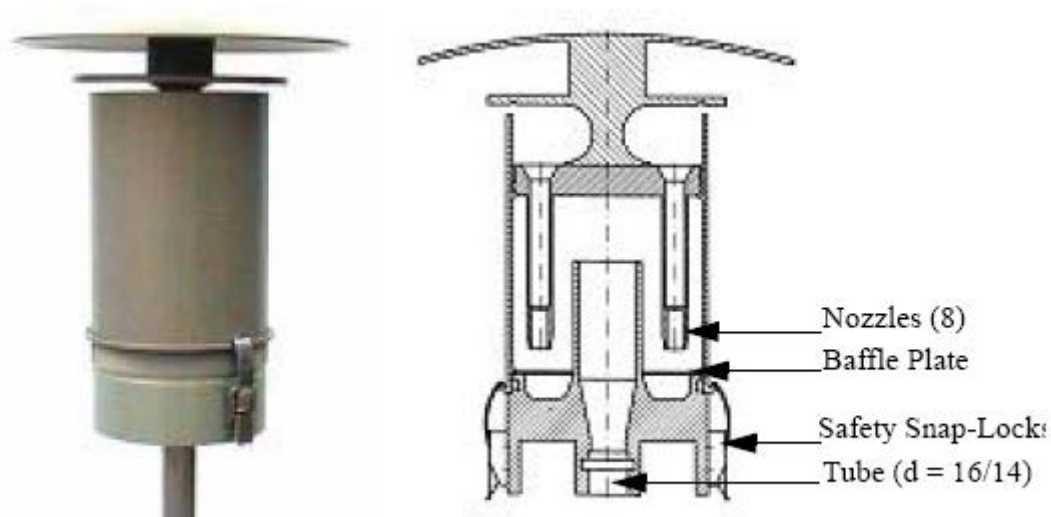
### 3.3 AMS scope and set-up

The measuring system comprises the PM<sub>2.5</sub> sampling inlet, the heated sampling tube (dynamic heating system DHS), the (optional) extension tube, the ambient air sensor (including radiation protection shield), the vacuum pump, the central unit 5014i including glass fibre filter tape, the respective connection lines, cables and adapters, roof bushing with flange, and a manual in German.



**Figure 3:** Model 5014i Beta

As sampling inlet, a PM<sub>2.5</sub> inlet (manufacturer: Digital, type: DPM2.5/01/00/16) which serves as pre-separator for suspended particles sucked in from outside air, is used. The instruments are operated at a constant volume flow rate adjusted to 16.67 l/min = 1.0 m<sup>3</sup>/h. It is also possible to use PM<sub>10</sub> and PM<sub>1</sub> sampling inlets instead.



**Figure 4:** (European) PM<sub>2.5</sub> sampling inlet for Model 5014i Beta

The heated sampling tube (approx. 0.9 m long) and the (optional) extension tube (approx. 1.8 m long) connect the sampling inlet to the actual measuring system. The adjustment of the sample heater (dynamic heating system DHS) is carried out as described in Section 3.2 Functionality of the measuring system.



**Figure 5:** Heated sampling tube (DHS)

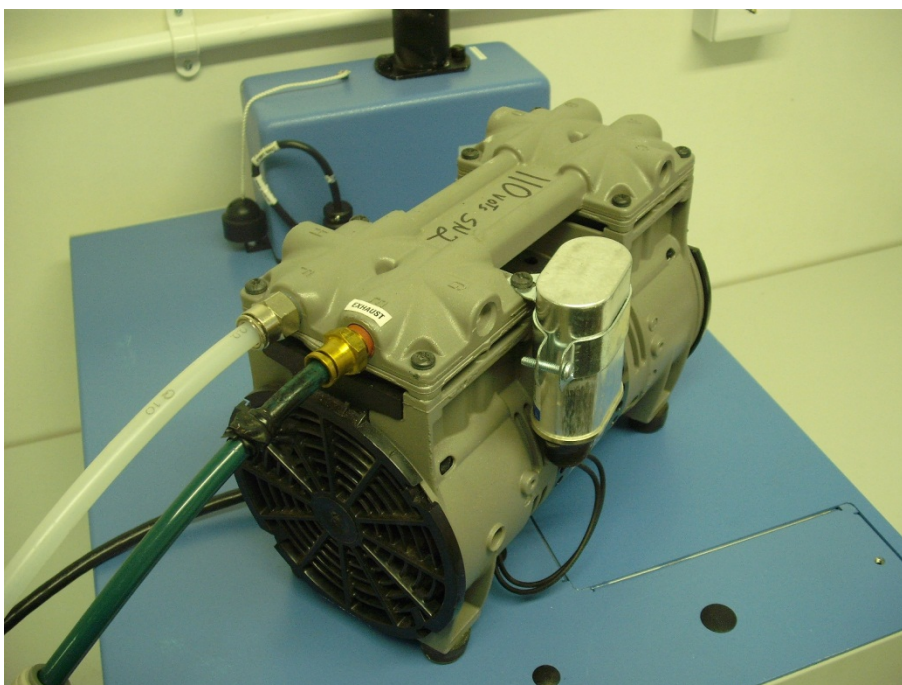


**Figure 6:** Model 5014i Beta measuring system – here as Model 5030i SHARP after disassembly of the nephelometer module





**Figure 7:** Model 5014i Beta measuring system (Systems 1 and 2 from right) at measuring station – here as Model 5030i SHARP with nephelometer module



**Figure 8:** Vacuum pump (type: GAST Model 75R647, PN 110836-00)

The measuring system is operated through pushbuttons and an LCD display on the front side of the instrument. Here, the user can retrieve measurement data and instrument information, change parameters and perform tests for controlling the functionality of the measuring system.

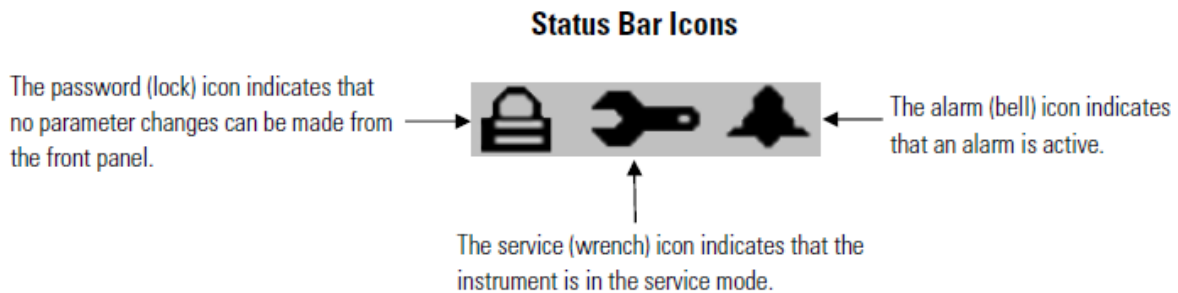



**Figure 9:** Main screen of the user interface



The main screen is on the top level of the user interface. It usually displays the PM concentration. By scrolling down with the arrow buttons ↑↓, the screens for ambient air conditions, flow conditions and mass sensor data are displayed.

In addition, the main screen displays a status bar with the current time as well as different status messages (e.g. the status of the measuring chamber). In some cases, the following symbols can be observed:



The main menu for operating the measuring system can be reached by pressing . This button always leads to the previous sub-menu.

The four keys directly below the LCD display are programmable soft keys – by default, the keys lead to the sub-menus “RANGE”, “AVG”, “DIAGS” and “ALARM”.

The sub-menu “Range” allows for setting the unit the concentration values are to be output in and adjusting standard as well as customised measuring ranges.

In the sub-menu “Integration Time” it is possible to adjust the averaging period of the radiometric measurement within the range 15 – 60 min (by default set to 20 min).

The sub-menu “24-Hour Average” allows the user to define the start time of the 24-hour averaging period of the concentration measurement.

The “Calibration Factors” sub-menu displays the calibration factors adjusted in the measuring system as well as those determined during manual and/or automatic calibrations. It is also possible to adjust them using this menu.

The “Instrument Controls” sub-menu may be selected to control various instrument operational parameters. It allows for parameterising the flow rate, turning the pump on and off, configuring the sample heater DHS, adjusting filter tape control operations (moving the tape manually, adjusting a reliable mass limit → during test: 1500 µg, setting a time and interval for the next filter tape change, etc.), determining volumetric conditions, configuring the internal data logging and communication settings, adjusting the screen contrast, turning the service mode on and off (wrench icon appears on the main screen when service mode is on) as well as setting up the date and time.

The “Diagnostics” sub-menu provides access to diagnostic information and functions, e.g. software version, current reading of the different sensors, radiometric detector status, status of the analogue and digital inputs and outputs, etc. This information is especially useful when troubleshooting the instrument.

The “Alarms” sub-menu displays the status of the measuring system with regard to potentially upcoming alarm messages. The bell icon on the main screen indicates that one (or more) alarm(s) are active.

The “Service” sub-menu (available only when the service mode is activated on the “Instrument Controls” sub-menu → if on, the wrench icon appears on the main screen) provides access to advanced diagnostic functions. These include, for example, the adjustment of the sensors with regard to ambient air temperature, flow temperature, ambient humidity, air pressure and flow. Furthermore, it allows for checking / adjusting the radiometric determination / mass coefficient, calibrating the detector (to be performed by a service technician of the manufacturer only) as well as setting up the analogue inputs and outputs.

The “Password” sub-menu allows the user to configure and activate password protection for the instrument (the lock icon on the main screen indicates that password protection is active).

Report on the suitability test of the ambient air quality measuring system  
Model 5014i Beta with PM<sub>2.5</sub> pre-separator of the company Thermo Fisher  
Scientific for the component suspended particulate matter PM<sub>2.5</sub>,  
Report No.: 936/21209885/H

Figure 10 provides an overview of the menu-assisted firmware.

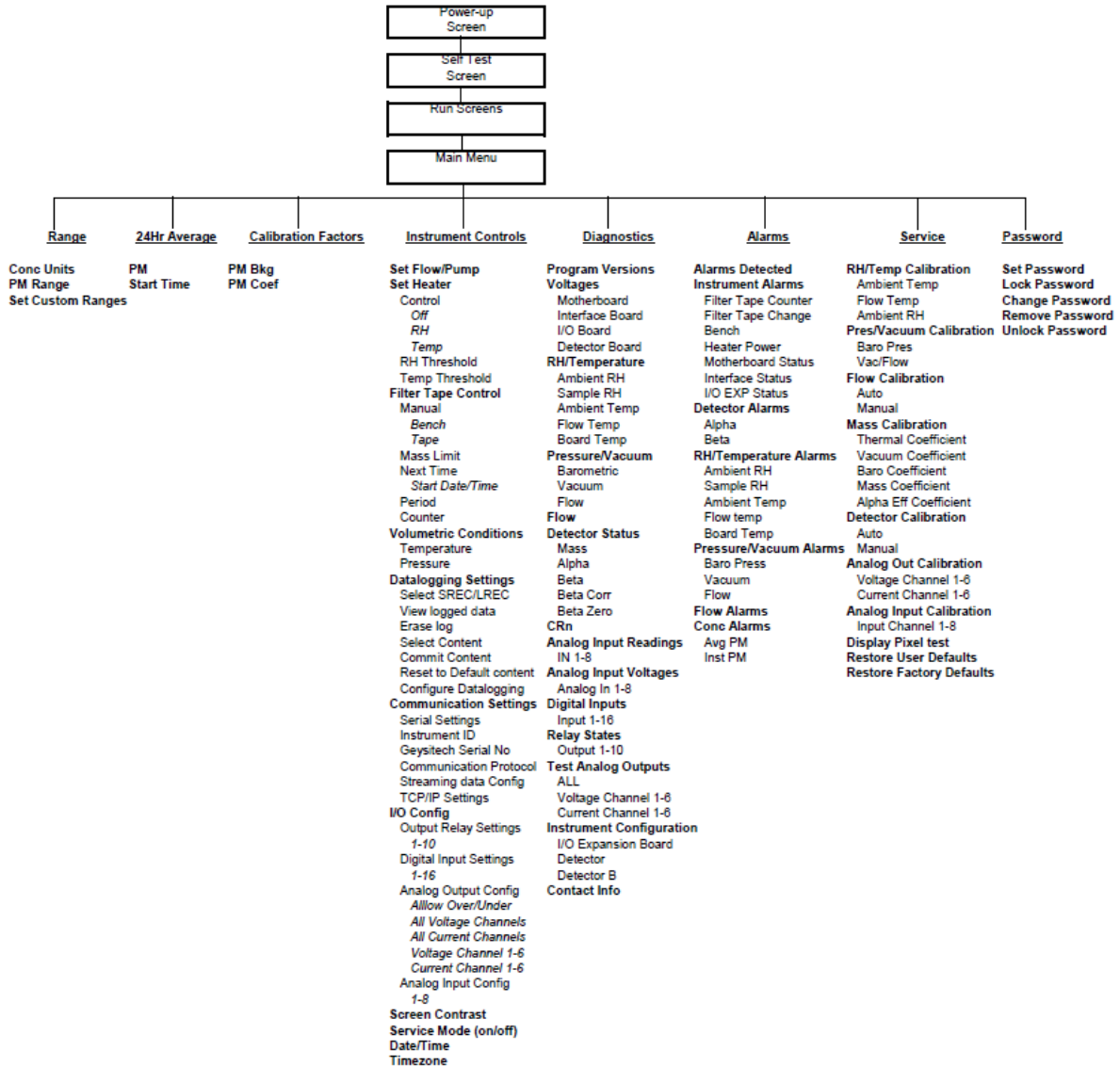


Figure 10: Flow chart – Overview of menu-assisted firmware

In addition to the possibility of direct communication via pushbuttons/display, the measuring system may be completely operated and parameterised over RS232/RS485 and Ethernet – both directly from a PC and indirectly via modem or network. During suitability testing, the measuring system was accessed over Ethernet and the terminal software iPort, especially for downloading the measurement data saved internally. The nature and scope of internal data logging (logging interval, recorded parameters) can be configured on the “Instrument Controls” menu. This remote operation of the measuring system contains the same features as direct operation.

The measuring system supports C-Link, MODBUS, Gesytec (Bayern-Hessen), ESM, Streaming Data and NTP protocols.

To perform external zero checks of the measuring system, a zero filter is mounted to the AMS inlet. This filter ensures the supply of air free of suspended particles.



**Figure 11:** Zero filter for supplying air free of suspended particles and its connection adapter

In order to check and, if required, calibrate the radiometric measurement, the manufacturer provides a set of mass transfer standard foils. This set comprises one null foil and two span foils. The null foil has the same approximate mass as a clean filter spot and the span foil is a calibrated mass increase above the null foil. Therefore, the foils come in a set and must not be mixed with other sets.



**Figure 12:** Set with foil holder and test foils

A special adapter for connecting an external flow measuring instrument is mounted to the inlet in order to check the leak tightness of the measuring system. The leak test adapter produces a high vacuum in the system. The leak tightness of the measuring system can be evaluated by comparing the flow rate measured by the system (at high vacuum) and the flow rate at the inlet (= external flow measuring instrument). If the difference exceeds the manufacturer's specification of 420 ml/min (= approx. 2.5 % of the nominal flow rate), the system shall be tested for leaks.

Report on the suitability test of the ambient air quality measuring system  
Model 5014i Beta with PM<sub>2.5</sub> pre-separator of the company Thermo Fisher  
Scientific for the component suspended particulate matter PM<sub>2.5</sub>,  
Report No.: 936/21209885/H



**Figure 13:** Leak test adapter



Table 3 contains a list of important technical data of the ambient air quality measuring system Model 5014i Beta for suspended particles.

**Table 3:** Technical data for Model 5014i Beta (manufacturer's specifications)

<b>Dimensions / Weight</b>	<b>Model 5014i Beta</b>
Measuring system	425 x 584 x 219 mm / 19 kg (without pump)
Sampling tube	Approx. 0.9 m long, isolated heated tube + 1.8 m extension tube
Sampling inlet	Depends on manufacturer, during suitability testing: Digitel DPM2.5/01/00/16
<b>Power requirements</b>	Analyser: 100-240 V, 50-60 Hz Pump: 115 V, 50-60 Hz
<b>Power input</b>	Approximate maximum of 880 W
<b>Ambient conditions</b>	
Temperature	+5 to +40 °C (during suitability testing)
Humidity	Non-condensing
<b>Sample flow rate (Inlet)</b>	16.67 l/min = 1 m <sup>3</sup> /h
<b>Radiometry Source</b>	<sup>14</sup> C, <3.7 MBq (< 100 µCi)
<b>Detector</b>	Proportional radiation detector
<b>Temporal resolution</b>	1 min
<b>Parameter: Filter change</b>	
Filter change: time (cycle)	0 h – 100 h → Default: 8 h (3 changes per day)
Filter change: particle mass	0 – 9999 µg → Default: 1500 µg
<b>Parameter: Sample heater</b>	
Max. heating temperature	30 °C (during suitability testing)
Nominal relative humidity	50 % / 58 % (during suitability testing)
<b>Data storage capacity (internal)</b>	Max. 190,000 datasets (> 650 d at storage intervals of 5 min)
<b>Instrument inputs and outputs</b>	Outputs: Analogue 0-20 mA or 4-20 mA (optional) Digital RS232, RS485, TCP/IP, 10 status relays Inputs: 16 digital inputs 8 analogue inputs (optional)

<b>Protocols</b>	Communication with PC over Ethernet and iPort software C-Link, MODBUS, Gesytec, ESM, Data Streaming and NTP Simultaneous connections from different locations over Ethernet
<b>Status signals / Error messages</b>	Available, for an overview please refer to Chapter 6 of the instruction manual



### 3.4 Differences between Model 5014i Beta and Model 5030i SHARP

Both measuring systems Model 5014i Beta and Model 5030i SHARP manufactured by Thermo Fisher Scientific are identical with regard to the configuration and functionality of the complete sampling system as well as of the radiometric assembly. The same hardware components, parameters and evaluation algorithms are used in both AMS for sampling and determining fine dust concentrations with a radiometric measurement method. The Model 5030i SHARP measuring system differs in hardware from the Model 5014i Beta measuring system in that the former has an additional nephelometric module. As for its software, Model 5030i SHARP integrates and evaluates the nephelometer's signal and produces hybrid values (nephelometer + radiometric measurement).

Table 4 below presents an overview of the hardware differences of both systems.

**Table 4:** Differences between Model 5014i Beta and Model 5030i SHARP, hardware

Differences	Model 5014i Beta	Model 5030i SHARP	Comment
Inlet T-fitting	X	✓	The SHARP uses a T-fitting to permit the introduction of filtered air for the purpose of zeroing the SHARP optics (nephelometer). The Beta has no inlet T-fitting.
Nephelometer	X	✓	The SHARP incorporates an external nephelometer assembly. The flow is laminar throughout and particle penetration is of a high efficiency (greater than that of a PM10 inlet)
Pump vacuum T-fitting	X	✓	The SHARP uses a push connect T-fitting with a 0.040" orifice open to atmosphere. This T-fitting is located downstream of the flow controller and upstream of the pump intake. This creates make-up air so that the pump exhaust flow is greater than the inlet flow. This make-up air is used to provide > 16.67 lpm at the inlet for zero air when the pump exhaust 3-way valve is activated. The Beta uses no T-fitting.
Pump exhaust zero valve	X	✓	The pump exhaust is routed through a HEPA filter and through a 3-way solenoid valve and vented to atmosphere. The valve is used to direct particle free air towards the inlet T-fitting for the purpose of zeroing the nephelometer. The Beta pump exhausts directly to atmosphere.
Inline HEPA Filters	X	✓	Two inline HEPA filters are used on the SHARP. The first is to clean the pump exhaust to avoid clogging the 3-way valve. The second is to provide particle-free air downstream of the activated 3-way valve for nephelometer auto-zero. The Beta does not make use of any HEPA filters.

Differences	Model 5014i Beta	Model 5030i SHARP	Comment
Sample heating	✓	✓	Both SHARP and Beta use precisely the same heating routine and the same reference points for controlling the sample to the preferred RH control or to the fixed sample temperature control.
PM data	✓	✓	The beta attenuation data for the 5014i and 5030i are the same. There are no differences in processing the particulate matter (PM) concentration for either device.

It is possible to reconfigure / upgrade Model 5014i Beta into Model 5030i SHARP. The procedure is described in detail in the manual of the Model 5030i SHARP measuring system (chapter 10). The implemented software allows for operating the AMS both as Model 5014i Beta and as Model 5030i SHARP. The switch-over between both modes of operation (DETECTOR: SHARP or BETA) is enabled in the menu Diagnostics/Instrument Configuration.

An influence of the additional hardware components of Model 5030i SHARP on the measured values of the radiometric measurement in the system is not expected. The data of the radiometric measurement of Model 5030i SHARP are therefore regarded as equivalent to those of Model 5014i Beta.

Accordingly, the present suitability test of Model 5014i Beta was performed with the hardware of Model 5030i SHARP (see test report 936/21209885/F) by evaluating the measured values of the respective radiometric measurement.

## **4. Test programme**

### **4.1 General**

The suitability test was carried out with two candidates of the type Model 5030i SHARP (see test report 936/21209885/F) by evaluating the measured values of the respective radiometric measurement. This is possible, because an influence of the additional hardware components of Model 5030i SHARP on the measured values of the radiometric measurement in the system is not to be expected. The data of the radiometric measurement of Model 5030i SHARP are therefore regarded as equivalent to those of Model 5014i Beta (see item 3.4 Differences between Model 5014i Beta and Model 5030i SHARP).

The suitability test was carried out with two instruments of identical design with the serial numbers SN 1 and SN 2.

The test started in the year 2009 with the software version V00.05.41.114. The software was steadily enhanced and optimised during the course of testing.

At the beginning of the field test in January 2011, software version V01.00.01.197 was implemented. This version was used during the whole field test.

The software was updated to version V01.00.03.225 after conclusion of the field regular test and before starting the remaining laboratory tests. This software version was as well used for the additional campaign "Bornheim, Summer 2013".

In the meantime the software version was updated another time due to a discontinuation of a processor board to version V02.00.00.232+.

The following software modifications were implemented:

**Table 5:** Overview of software versions during suitability testing

Version	Description of change	Status during suitability test
V00.05.41.114	Initial version	Installed during laboratory test, part 1
V01.00.00.163	<ol style="list-style-type: none"> <li>1. Integration of support for Model 5030i</li> <li>2. Improvement of algorithms for controlling RH and TEMP</li> <li>3. Addition of "Carriage return" to ESM protocol</li> <li>4. Replacement of term "Zero" with "Offset"</li> <li>5. Adjustment of digital filter for "Mass" and "PM" to 60 min</li> <li>6. Elimination of sample temperature from user interface</li> <li>7. Raise of limit for Temp offset values to +/- 10°C</li> <li>8. Implementation of mass determination without flow in service mode for improving the calibration of mass measurement</li> <li>9. Implementation of the "Infinite Mass Accumulation Method"</li> </ol>	Not installed
V01.00.01.197	<ol style="list-style-type: none"> <li>1. Release of Model 5030i code</li> <li>2. Integration time variable for mass and concentration determination (range 15 – 60 min) added</li> <li>3. Necessary code adjustments for the amplifier, due to the change from batteries to capacitor for buffering high voltage supply for up to 2 h during power outages</li> <li>4. Increase of filter tape movements per roll by approx. 50 %</li> <li>5. Change of filter tape after three failed attempts no longer possible</li> <li>6. Elimination of minor bugs</li> </ol>	Installed during field test

V01.00.02.199	<ol style="list-style-type: none"> <li>1. Calibration coefficient is frozen at c (BETA) &lt; 2.5 µg/m<sup>3</sup> and/or c (NEPH) &lt; 1 µg/m<sup>3</sup> instead of c (BETA) &lt; 2.5 µg/m<sup>3</sup> and/or c (SHARP) &lt; 1 µg/m<sup>3</sup></li> <li>2. Flow temp replaced by sample temp in Bayern-Hessen protocol</li> <li>3. Increase of accuracy of "diag volts" command</li> </ol>	Not installed
V01.00.03.225	<ol style="list-style-type: none"> <li>1. Modification of key variables and soft keys for USB keypad support</li> <li>2. Alarms added to the list of digital outputs</li> <li>3. Additional parameters for recording added</li> <li>4. Changes to timing procedure after filter exchange – no calculations in the first 15 min following pump stop</li> <li>5. Update of algorithms for calculating ambient temperature, ambient humidity and flow temperature in order to provide a more precise sample humidity value (sample rH)</li> <li>6. Recording of amplification and mode for NEPH added</li> <li>7. Update of pressure calculations smoothing in order to improve flow control</li> <li>8. Update of heating control (PID control optimised)</li> </ol>	Installed during laboratory test, part 2, as well as the additional campaign "Bornheim, Summer 2013"
V02.00.00.232+	<ol style="list-style-type: none"> <li>1. Modification to new i-series processor board 110570</li> <li>2. Menu navigation "Service/Pres/Vacuum Calibration/Vac/Flow" changed</li> <li>3. Diagnostics/Voltages/detector Board menu no longer locks up</li> <li>4. Title line on "Calibration factors/Neph BKG Values/restore Prev Values" displaced</li> <li>5. "range" Clink command now deliberately writes a response in every case</li> <li>6. Several parameters are no longer displayed when the unit is password locked</li> <li>7. Remove blanket rejection of "set" for the "sp field" Clink command</li> </ol>	Not installed, examined during regular production audit.

The reliability of the AMS was consistently increased with every change. The changes introduced up to version V02.00.00.232+ are not expected to affect the performance of the AMS significantly.

The suitability test comprised a laboratory test for determining the system's performance characteristics and a field test carried out over several months at different locations.

All determined concentrations are given as  $\mu\text{g}/\text{m}^3$  (operating conditions).

The report in hand provides a description of the minimum requirement for each test item in accordance with the number and wording used in standards [1, 2, 3, 4].

## 4.2 Laboratory test

The laboratory test was carried out with two identical instruments of the type Model 5030i SHARP with serial numbers SN 1 and SN 2 (see test report 936/21209885/F) by evaluating the measured values of the respective radiometric measurements. In conformity with standards [1, 2], the following performance criteria were tested in the laboratory:

Laboratory test, part 1 (2009):

- Description of system functions
- Determination of dependence of sensitivity on ambient temperature
- Determination of dependence of sensitivity on mains voltage

Laboratory test, part 2 (2012/2013):

- Detection limit
- Determination of the dependence of zero point / sensitivity on ambient temperature
- Determination of the dependence of zero point / sensitivity on the mains voltage
- Tightness of the sampling system

The following auxiliary devices were used to determine the system characteristics during the laboratory test:

- Climatic chamber (temperature range from -20 °C to +50 °C, accuracy < 1 °C)
- Adjustable isolating transformer
- Zero filter for external zero point checks
- Span foil sets

The measured values were recorded internally by the instruments. Once stored in the systems, they were transmitted via Ethernet to the iPort software for read-out.

The laboratory tests and results are presented in Section 6.

### 4.3 Field test

The field test was carried out with two identical systems with the serial numbers:

System 1: SN 1

System 2: SN 2

The following performance criteria were tested in the field:

- Comparability of the candidates according to the Guide “Demonstration of Equivalence of Ambient Air Monitoring Methods”
- Comparability of the candidates with the reference methods according to the Guide “Demonstration of Equivalence of Ambient Air Monitoring Methods”
- Calibratability, analytical function
- Reproducibility
- Zero drift and sensitivity
- Dependence of the measured values on sample humidity
- Maintenance interval
- Availability
- Constancy of sample volumetric flow
- Overall uncertainty of the test candidates

The following auxiliary devices were used during the field test:

- Measuring cabinet provided by TÜV Rheinland, air-conditioned to approx. 20 °C
- Measuring cabinet for low-volume samplers provided by DEFRA (UK), air-conditioned to approx. 20 °C
- Weather station (WS 500 manufactured by ELV Elektronik AG for use in Germany and MK III Series manufactured by Rainwise (US) for use in the UK) for the determination of meteorological characteristics such as air temperature, air pressure, air humidity, wind velocity, wind direction and precipitation
- 2 reference samplers LVS3 for PM<sub>2.5</sub> in accordance with point 5
- 1 gas meter, dry
- 1 mass flow meter Model 4303 (manufactured by TSI)
- 1 mass flow meter type BIOS volumeter (manufactured by BIOS) for use in the UK
- 1 mass flow meter type TetraCal venturi (manufactured by BGI), for use in the UK
- Power consumption measuring device type Metratester 5 (manufactured by Gosen Metrawatt)
- Zero filter for external zero point checks
- Span foil sets

Two candidate systems and two PM<sub>2.5</sub> reference instruments were each operated simultaneously for 24 h during the field test. The reference equipment worked discontinuously, i.e. the filter had to be changed manually after each sample drawing.



The impaction plates of the PM<sub>2.5</sub> sampling inlets of the reference devices were cleaned approx. every 2 weeks and lubricated with silicone grease in order to guarantee a safe separation and deposition of the particulate. The PM<sub>2.5</sub> sampling inlets of the candidates were cleaned approx. every 4 weeks. The inlet was cleaned according to the manufacturer's instruction while taking into account the local suspended particle concentrations.

The flow rate was tested on each candidate and reference device prior to and after each change of location with a dry gas meter and a mass flow meter connected with a hose to the air inlet.

### Test sites and arrangement of the measuring systems

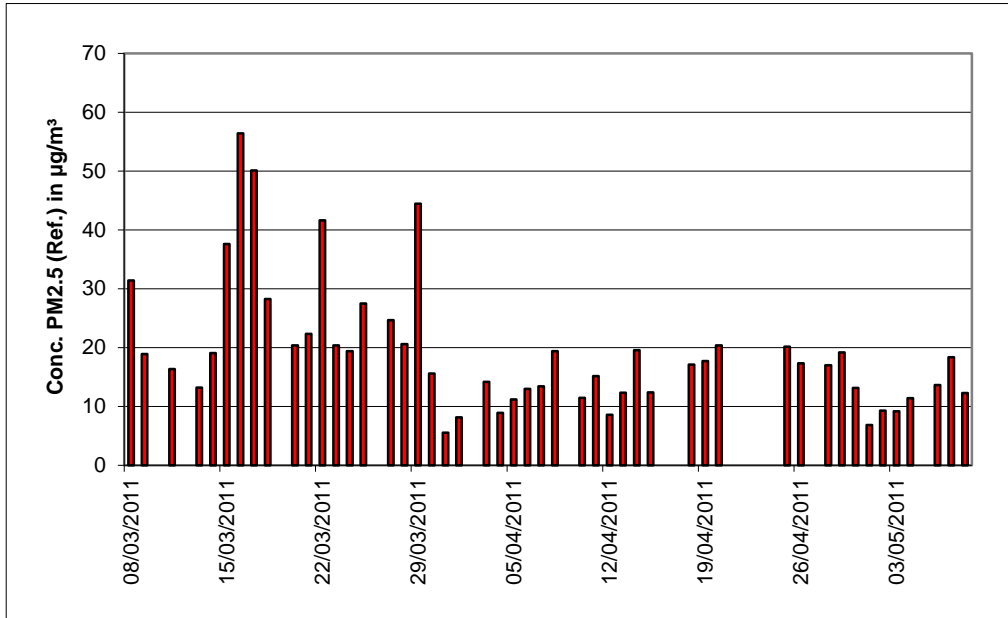
During the field test, the measuring systems were arranged in such a way that the sampling inlets were positioned outside the measuring cabinet above its roof. The central units of both candidates were located inside the air-conditioned measuring cabinet. The entire reference equipment (LVS3) was placed outdoors on the roof of the cabinet.

The field test was carried out at the following test sites:

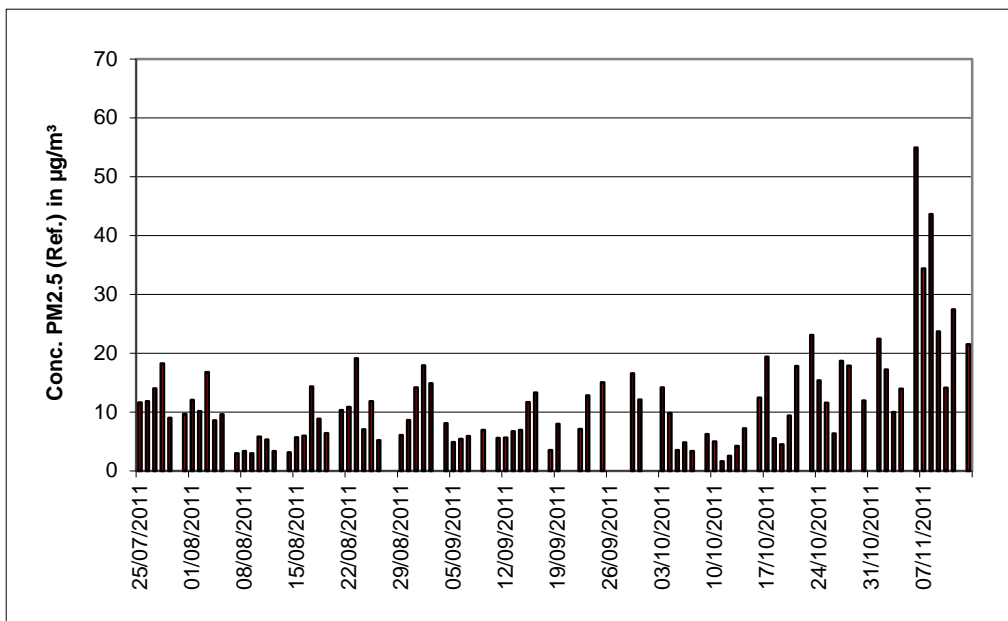
**Table 6:** Field test sites

No.	Measurement site	Period	Characteristics
1	Cologne, parking lot, winter	03/2011 – 05/2011	Urban background
2	Bornheim, motorway parking lot, summer	07/2011 – 11/2011	Rural structure + traffic influence
3	Bornheim, motorway parking lot, winter	01/2012 – 03/2012	Rural structure + traffic influence
4	Teddington, summer	07/2012 – 10/2012	Urban background

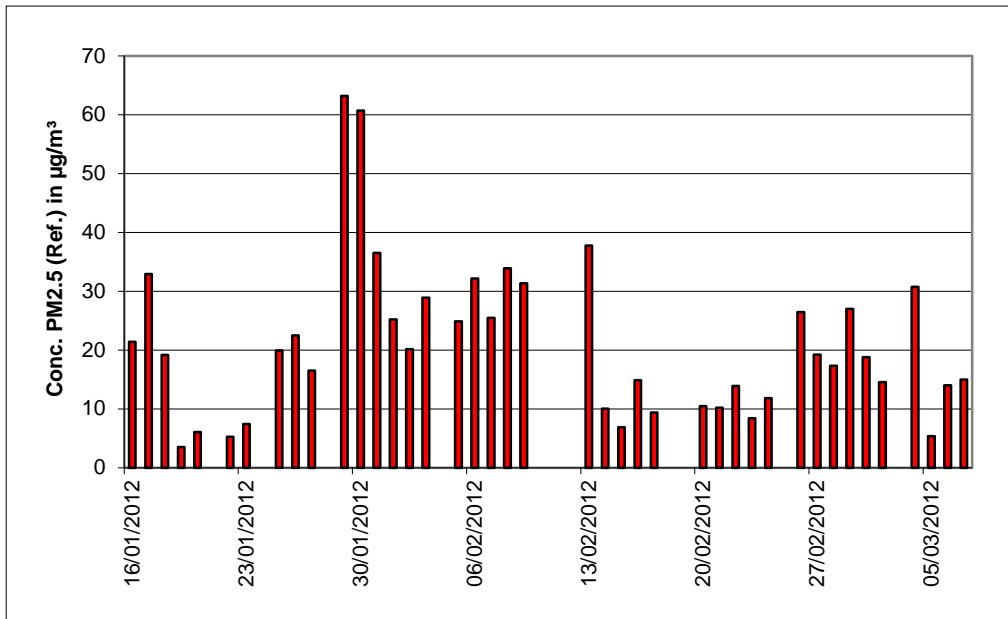
Figure 14 to Figure 17 show the course of PM<sub>2.5</sub> concentrations at the field test sites obtained with the reference systems.



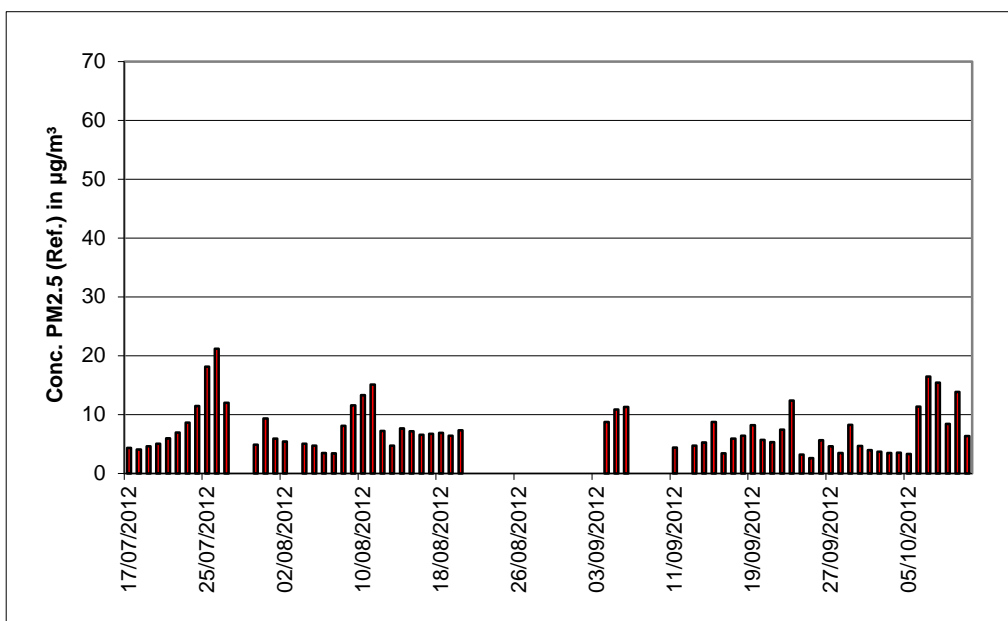
**Figure 14:** Course of PM<sub>2.5</sub> concentrations (reference) at the test site “Cologne, parking lot, winter“



**Figure 15:** Course of PM<sub>2.5</sub> concentrations (reference) at the test site “Bornheim, motorway parking lot, summer“



**Figure 16:** Course of PM<sub>2.5</sub> concentrations (reference) at the test site “Bornheim, motorway parking lot, winter“



**Figure 17:** Course of PM<sub>2.5</sub> concentrations (reference) at the test site “Teddington, summer“

The following figures show the measuring cabinet at the field test sites Cologne (parking lot),  
Bornheim (motorway parking lot) and Teddington.



**Figure 18:** Field test site Cologne, parking lot



**Figure 19:** Field test site Bornheim, motorway parking lot



**Figure 20:** Field test site Teddington

In addition to the measuring systems used for determining the content of suspended particulate matter in ambient air, a data acquisition system was installed at the cabinet/measurement site in order to determine the meteorological characteristics. Air temperature, pressure and humidity as well as wind velocity, direction and precipitation were continuously assessed and their half-hourly averages recorded.

The installation of the cabinet itself and the arrangement of the sampling probes are described as follows:

- Height of cabinet roof: 2.50 m
- Height of the sampling point for testing 1.10 m / 0.51 m above the cabinet roof
- Reference instrument 3.61 / 3.01 m above ground
- Height of weather vane: 4.5 m above ground (Germany)  
2.5 m above ground (UK)

Table 7 contains, therefore, not only an overview of the most important meteorological factors determined during measurement at the four test sites, but also an overview of the PM ratio during the entire test. The individual values are presented in annexes 5 and 6.

**Table 7:** Ambient conditions at the field test sites, daily mean values

	Cologne, parking lot, winter	Bornheim, motorway parking lot, summer	Bornheim, motorway parking lot, winter	Teddington (UK), summer
No. of paired values (reference)	48	87	41	65
<b>Ratio PM<sub>2.5</sub>/PM<sub>10</sub> [%]</b>				
Range	38.8 – 86.3	27.1 – 88.1	43.1 – 91.1	36.2 – 70.5
Average	61.7	57.3	73.0	53.9
<b>Ratio Volatiles/PM<sub>2.5</sub> [%]*</b>				
Range	11.0 – 44.8	0.0 - 53.3	10.4 – 73.2	10.8 – 70.8
Average	26.2	21.6	25.2	34.3
<b>Air temperature [°C]</b>				
Range	5.0 – 22.1	5.2 – 24.5	-8.9 – 10.4	8.9 – 24.2
Average	12.3	15.5	1.9	16.4
<b>Air pressure [hPa]</b>				
Range	998 – 1031	995 – 1024	1003 – 1031	971 – 1010
Average	1012	1008	1018	996
<b>Rel. humidity [%]</b>				
Range	34.7 – 90.4	53.8 – 91.1	50.2 – 90.5	47.1 – 94.6
Average	61.8	75.1	77.7	72.7
<b>Wind velocity [m/s]</b>				
Range	0.3 – 5.3	0.3 – 4.1	0.6 – 5.7	0.1 – 1.9
Average	1.9	1.4	2.1	0.5
<b>Precipitation [mm/d]</b>				
Range	0.0 – 11.1	0.0 – 51.7	0.0 – 12.8	0.0 – 30.0
Average	0.9	2.7	1.5	1.6

\* The content of volatiles was measured with a TEOM-FDMS system operated simultaneously



## Parameterisation of the relative humidity threshold for the Dynamic Heating System DHS

The Model 5014i Beta measuring system uses a heated sampling system in order to prevent the effects of condensation in the system (especially in the filter tape). The heater must also be designed in such a way that the potential risk of volatile particle loss is minimised. The Dynamic Heating System DHS implemented in the Model 5014i Beta measuring system ensures that the relative humidity of the air passing through the filter tape at the radiometric stage is kept well below the point at which the collected particles adhere together, thus producing disrupting condensation effects. Furthermore, the relative humidity in the system is adjusted below the specified limit. The system minimises the increase of internal temperature. This ensures a negligible loss of semi-volatile particle components, provided that the relative ambient humidity is maintained below the limit to which the heater is adjusted. As that the relative ambient humidity rises above the threshold, the applied heating is optimised to maintain the relative humidity threshold above the filter tape of the radiometric stage. The DH-System is adjusted using the controlled variable rH (= "rel. ambient humidity of the sample" → calculated from the rel. humidity of ambient air, ambient temperature and sample temperature) and the filter temperature sensor. The heating conditions can be adjusted according to the requirements of each measurement network.

The parameters were adjusted as follows during suitability testing:

Rel. air humidity threshold: 50 %

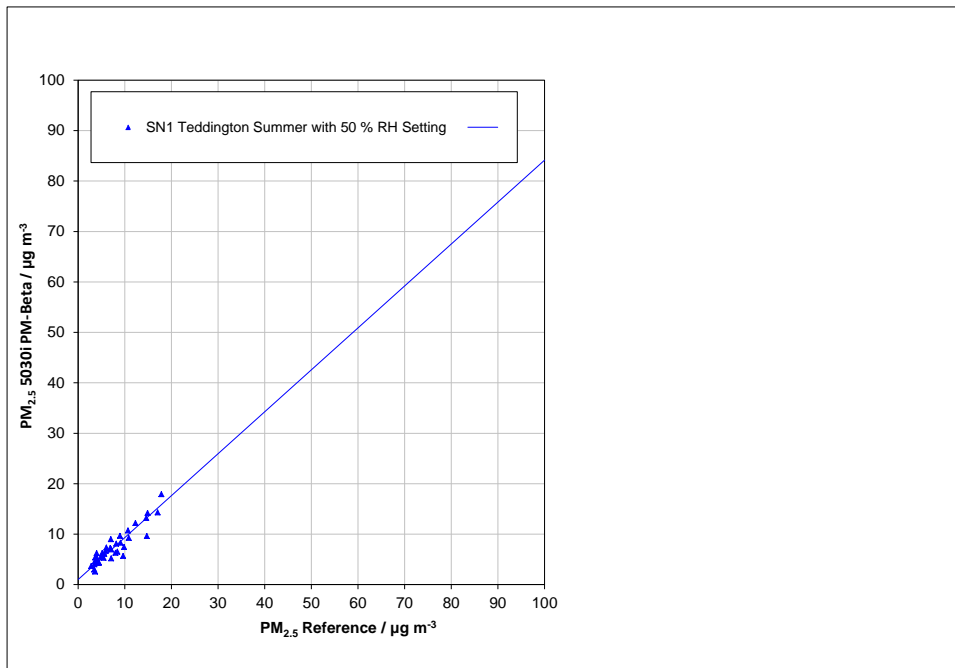
Filter temperature sensor: max. 30 °C

This means that the heater turns on as soon as the relative humidity rH rises above 50 %. However, the filter temperature does not exceed 30 °C. The relative humidity threshold value of 50 % was specified by the manufacturer, since it represents the filter conditioning value of the gravimetric reference method.

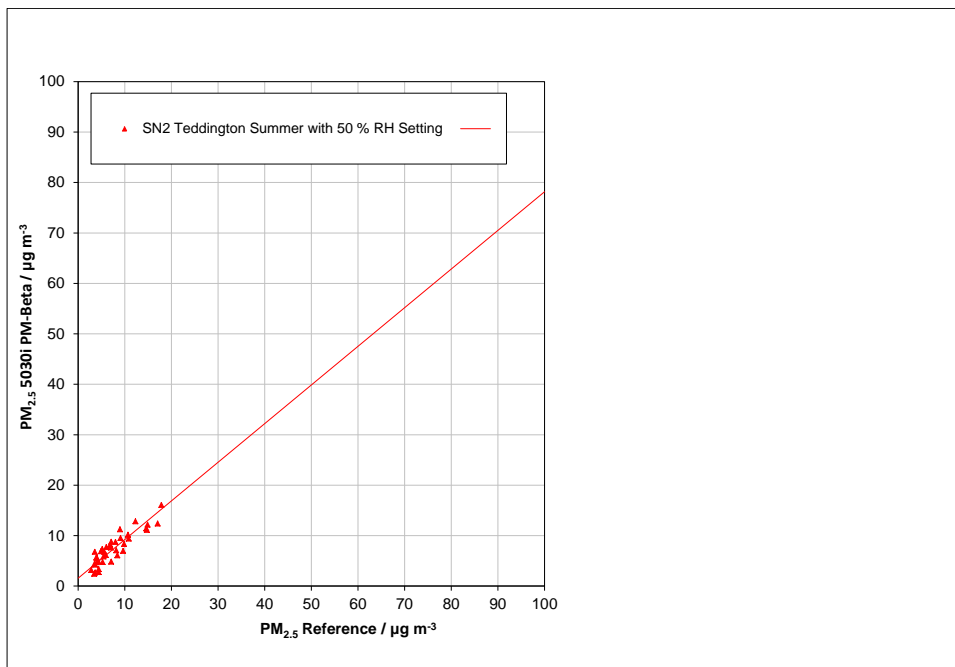
None of the slopes or offsets determined from the comparison with the reference method were significantly visible during the comparison campaigns at the test sites Cologne (winter), Bornheim (summer) and Bornheim (winter). All expanded measurement uncertainties calculated according to the Guide "Demonstration of Equivalence of Ambient Air Monitoring Methods" [4] lay below the maximum permissible value of 25 % without application of correction factors. After concluding the measurements in Germany, the final comparison campaign started in summer of 2012 at the test site Teddington. During this campaign, an underestimation of the suspended particulate content measured by the candidates was observed in comparison with the reference method. The evaluation of the campaign led to the following results:

**Table 8:** Evaluation of the Teddington (summer) campaign with rH adjusted to 50 %

PM2.5 5030i PM-Beta	Dataset	Orthogonal Regression				Limit Value of 30 µg m <sup>-3</sup>	
		n <sub>C-S</sub>	r <sup>2</sup>	Slope (b) +/- u <sub>b</sub>	Intercept (a) +/- u <sub>a</sub>	W <sub>CM</sub> / %	% ≥ 17 µg m <sup>-3</sup>
SN1	Teddington Summer with 50 % RH Setting	38	0.860	0.832 +/- 0.053	0.992 +/- 0.450	28.43	5.3
SN2	Teddington Summer with 50 % RH Setting	38	0.806	0.766 +/- 0.058	1.546 +/- 0.494	37.67	5.3



**Figure 21:** Comparison of reference and candidate SN 1, measured component PM<sub>2.5</sub>, Teddington (summer), relative humidity threshold adjusted to 50 %



**Figure 22:** Comparison of reference and candidate SN 2, measured component PM<sub>2.5</sub>, Teddington (summer), relative humidity threshold adjusted to 50 %



Since these parameters differ from the ones determined during previous campaigns, the possible causes for this discrepancy were analysed. In this context, the volatile content in fine dust was reviewed in detail. The content of volatiles in suspended particulate matter had been determined in measurements carried out in parallel with measuring systems of the type TEOM-FDMS. The results showed that the test site Teddington (summer) is characterised by a generally very low level of suspended particulate matter and a significantly high content of volatile dust components. The average content of volatiles in suspended particulate matter PM<sub>2.5</sub> amounted to approx. 35 % during the campaign carried out in Teddington (summer), compared to a content of approx. 20 – 25 % during the three previous campaigns.

Based on similar experiences during measurement campaigns in China, the manufacturer suggested a change in the parameterisation of the relative air humidity threshold from 50 % to 58 % to solve the problem. This would activate the heater only when the relative humidity exceeds 58 % instead of 50 % as in the previous campaigns. The Teddington (summer) comparison campaign was subsequently repeated using the new parameters (average volatile content during this campaign: 34.3 %). No problems demonstrating the equivalence during this measurement campaign were detected after applying this change. The results are presented in detail in Section 6.1 5.4.10 Calculation of the expanded uncertainty of the instruments.

Table 7 and Annex 6 of this report present the results of the measurement campaigns with regard to content of volatiles in suspended particulate matter PM<sub>2.5</sub>.

To qualify the necessary change of the threshold for the relative humidity to control the sample heating from originally 50% to 58% (necessary due to the results of the campaign in Teddington UK), an additional campaign at one of the German sites with two candidate systems with settings of each 50 % and 58 % was performed (decision of the 32. Expert discussion "test reports" of May 14/15 201) **Table 2** gives an overview on the additional campaign. The results of this campaign are shown in chapter 4.3 Field test from page 52.

The tests were performed at the site Bornheim with the candidate systems SN 1 and SN 2. The candidates were set up as follows:

	Component	threshold for heater regulation
SN 1	PM <sub>2.5</sub>	58 %
SN 2	PM <sub>2.5</sub>	50 %

The following test program was performed:

- comparison campaign with a minimum of 40 valid paired values reference vs candidate system
- determination of the uncertainty between candidate systems  $u_{bs}$  according to Guide
- determination of the expanded uncertainty of the candidate systems according to Guide
- application of the correction factors/ terms determined in chapter 6.1 5.4.10 Calculation of the expanded uncertainty of the instruments
- recalculation of equivalence of the 4 data sets from the existing suitability test and the additional data set "Bornheim Summer 2013 with different thresholds for the heater regulation according to the approach from point "8.2 Suitability testing" der CEN/TS 16450 [9]

The additional campaign was performed between 07 June 2013 and 25 July 2013. The ambient conditions during the campaign were as follows:

**Table 9:** Ambient conditions at the additional site “Bornheim, Summer 2013”, shown as daily mean values

	Bornheim, motorway parking lot, summer 2013
No. of paired values (reference)	44
<b>Ratio PM<sub>2.5</sub>/PM<sub>10</sub> [%]</b> Range Average	39.1 – 75.1 59.9
<b>Ratio Volatiles/PM<sub>2.5</sub> [%]*</b> Range Average	4.7 – 38.4 17.4
<b>Air temperature [°C]</b> Range Average	13.2 – 27.6 19.8
<b>Air pressure [hPa]</b> Range Average	1001 – 1020 1010
<b>Rel. humidity [%]</b> Range Average	52.2 – 86.1 67.8
<b>Wind velocity [m/s]</b> Range Average	0.2 – 3.5 1.2
<b>Precipitation [mm/d]</b> Range Average	0.0 – 34.6 3.2

All values are to be found in Appendix 7 (PM-measuring values) and 8 (ambient conditions).

In total 45 paired values were determined. A Significant outlier according to Grubbs is the paired value for the reference PM<sub>2.5</sub> of 18 July 2013 (Ref1: 11.3µg/m<sup>3</sup>; Ref2: 9.0 µg/m<sup>3</sup>). These values were discarded from the data pool. Therefore 44 paired values are available for evaluation.

The evaluation of the comparison measurements according to the Guide [4] leads to the following result:

**Table 10:** Results of the equivalence test at the site Bornheim, Summer 2013, SN 1 (58 %) & SN 2 (50 %), component PM<sub>2.5</sub>, raw data

SN1	Dataset	Orthogonal Regression				Limit Value of 30 µg m-3	
		n <sub>C-S</sub>	r <sup>2</sup>	Slope (b) +/- u <sub>b</sub>	Intercept (a) +/- u <sub>a</sub>	W <sub>CM</sub> / %	% ≥ 17 µg m-3
Individual Datasets	Bornheim Summer 2013	44	0.892	1.082 +/- 0.055	1.497 +/- 0.667	29.34	11.4
SN2	Dataset	Orthogonal Regression				Limit Value of 30 µg m-3	
		n <sub>C-S</sub>	r <sup>2</sup>	Slope (b) +/- u <sub>b</sub>	Intercept (a) +/- u <sub>a</sub>	W <sub>CM</sub> / %	% ≥ 17 µg m-3
Individual Datasets	Bornheim Summer 2013	44	0.861	0.945 +/- 0.055	1.435 +/- 0.669	12.99	11.4

**Assessment:**

1. The uncertainty between the two candidate systems is 1.54 µg/m<sup>3</sup> and thus is below the permissible 2.5 µg/m<sup>3</sup>
2. The expanded uncertainty for the raw data for SN 1 (58 %) is higher as the acceptable 25 %, the expanded uncertainty for the raw data for SN 2 (50 %) is below the permissible 25 %.

The correction factors/ terms detected during suitability testing in 6.1 5.4.10 Calculation of the expanded uncertainty of the instruments are afterwards applied to the raw data sets.

Therefore a correction of the data sets for SN 1 and SN 2 with a slope of 1.070 (uncertainty of slope 0.013) is carried out. This results to the following evaluation:

**Table 11:** Results of the equivalence test at the site Bornheim, summer 2013, SN 1 (58 %) & SN 2 (50 %), component PM<sub>2.5</sub>, slope correction 1.070

SN1	Dataset	Orthogonal Regression				Limit Value of 30 µg m-3	
		n <sub>C-S</sub>	r <sup>2</sup>	Slope (b) +/- u <sub>b</sub>	Intercept (a) +/- u <sub>a</sub>	W <sub>CM</sub> / %	% ≥ 17 µg m-3
Individual Datasets	Bornheim Summer 2013	44	0.892	1.007 +/- 0.051	1.443 +/- 0.623	16.46	11.4
SN2	Dataset	Orthogonal Regression				Limit Value of 30 µg m-3	
		n <sub>C-S</sub>	r <sup>2</sup>	Slope (b) +/- u <sub>b</sub>	Intercept (a) +/- u <sub>a</sub>	W <sub>CM</sub> / %	% ≥ 17 µg m-3
Individual Datasets	Bornheim Summer 2013	44	0.861	0.878 +/- 0.051	1.392 +/- 0.625	19.40	11.4

**Assessment:**

- 1 The expanded uncertainty of the data corrected by the slope of 1.070 lies for SN 1 (58 %) and SN 2 (50 %) beneath the allowed 25 %.

Closing, the corrected data set for Bornheim, Summer 2013 was included in the original equivalence evaluation from suitability testing (see Table 38) according to point "8.2 Suitability testing of CEN/TS 16450 [9] as additional 5th data set, to check whether the criteria for equivalence test are still fulfilled.

**Table 12:** Results of the equivalence test "suitability testing + Bornheim, summer 2013", SN 1 & SN 2, component PM<sub>2.5</sub>, slope correction 1.070

PM2.5 5014i Beta Slope Corrected	25.1% ≥ 17 µg m-3	Orthogonal Regression				Between Instrument Uncertainties	
	W <sub>CM</sub> / %	n <sub>C-S</sub>	r <sup>2</sup>	Slope (b) +/- u <sub>b</sub>	Intercept (a) +/- u <sub>a</sub>	Reference	Candidate
All Data	12.0	251	0.968	0.994 +/- 0.011	0.381 +/- 0.189	0.59	1.21
< 18 µg m-3	15.5	197	0.875	1.060 +/- 0.027	-0.098 +/- 0.268	0.53	1.15
≥ 18 µg m-3	16.7	54	0.954	1.026 +/- 0.030	-0.948 +/- 0.928	0.77	1.60
SN1	Dataset	Orthogonal Regression				Limit Value of 30 µg m-3	
		n <sub>C-S</sub>	r <sup>2</sup>	Slope (b) +/- u <sub>b</sub>	Intercept (a) +/- u <sub>a</sub>	W <sub>CM</sub> / %	% ≥ 17 µg m-3
Individual Datasets	Bornheim Winter	41	0.979	1.018 +/- 0.023	-0.130 +/- 0.580	12.30	56.1
	Cologne Winter	41	0.976	1.011 +/- 0.025	0.325 +/- 0.563	12.47	53.7
	Bornheim Summer	78	0.940	1.005 +/- 0.028	0.254 +/- 0.394	14.12	15.4
	Teddington Summer	55	0.834	0.950 +/- 0.053	0.071 +/- 0.455	14.99	3.6
	Bornheim Summer 2013	44	0.892	1.007 +/- 0.051	1.443 +/- 0.623	16.46	11.4
Combined Datasets	< 18 µg m-3	204	0.852	1.110 +/- 0.030	-0.500 +/- 0.299	22.30	4.4
	≥ 18 µg m-3	55	0.955	1.041 +/- 0.030	-1.069 +/- 0.921	16.73	100.0
	All Data	259	0.963	1.013 +/- 0.012	0.246 +/- 0.203	13.66	24.7
SN2	Dataset	Orthogonal Regression				Limit Value of 30 µg m-3	
		n <sub>C-S</sub>	r <sup>2</sup>	Slope (b) +/- u <sub>b</sub>	Intercept (a) +/- u <sub>a</sub>	W <sub>CM</sub> / %	% ≥ 17 µg m-3
Individual Datasets	Bornheim Winter	41	0.969	1.036 +/- 0.029	-0.522 +/- 0.717	15.84	56.1
	Cologne Winter	43	0.971	0.977 +/- 0.026	1.265 +/- 0.575	12.81	53.5
	Bornheim Summer	70	0.941	0.860 +/- 0.026	1.641 +/- 0.362	20.89	15.7
	Teddington Summer	65	0.787	0.910 +/- 0.053	0.631 +/- 0.451	18.17	3.1
	Bornheim Summer 2013	44	0.861	0.878 +/- 0.051	1.392 +/- 0.625	19.40	11.4
Combined Datasets	< 18 µg m-3	209	0.832	1.044 +/- 0.030	0.005 +/- 0.296	14.96	4.8
	≥ 18 µg m-3	54	0.937	1.027 +/- 0.036	-1.371 +/- 1.094	20.18	100.0
	All Data	263	0.955	0.982 +/- 0.013	0.438 +/- 0.212	13.79	24.3

### Assessment summary

To verify the equivalence of the data between both candidates with the threshold set for the heating of 50 % respectively 58 % a comparison campaign was performed at one of the German sites. The gathered data sets (SN 1 with 58 % setting, SN 2 with 50 % setting) were subjected to an equivalence test. The assessment led to the following results:

1. The uncertainty between the two candidate systems is 1.54 µg/m<sup>3</sup> and thus is below the permissible 2.5 µg/m<sup>3</sup>
2. The expanded uncertainty of the data corrected by the slope of 1.070 is for SN 1 (58 %) and SN 2 (50 %) below the permissible 25 %
3. The combined evaluation of the 4 original data sets of suitability testing with the additional 5<sup>th</sup> data set Bornheim, summer 2013 leads as well to a compliance with the equivalence criteria according to the guide [4]

Hence the verification of the equivalence of the candidate systems with a threshold for the rel. humidity of 58 % was proved also for a German site.

Therefore, the Model 5014i Beta measuring system can alternatively as well be operated with a relative humidity threshold of 58 %, in particular for any site where a significantly high volatile content is expected.

### Sampling period

EN 14907 defines a sampling period of 24 h ± 1 h.

The sampling period was set to 24 h for all instruments during the entire field test (10:00 – 10:00 in Teddington and Cologne, and 7:00 – 7:00 in Bornheim).

### Data handling

All paired reference values determined during the field tests were subject to statistical testing according to Grubbs (99 %) to prevent influences of clearly implausible data on the measurement results. Paired values identified as significant outliers may be discarded from the data pool as long as the critical value of the test statistic does not fall below the target. The January 2010 version of Guide [4] stipulates that only 2.5 % of the paired values may be identified as outliers and discarded.

During the “Combined MCERTS and TÜV PM Equivalence Testing” programme we agreed with our British partners not to discard any value measured by the candidates, unless the implausibility is attributed to technical causes. Thus, no values measured by the candidates were discarded during the entire testing period.

Table 13 shows an overview of the amount of paired values (reference) recognised as significant outliers and discarded at each test site.

**Table 13:** Results of Grubbs outlier test – Reference PM<sub>2.5</sub>

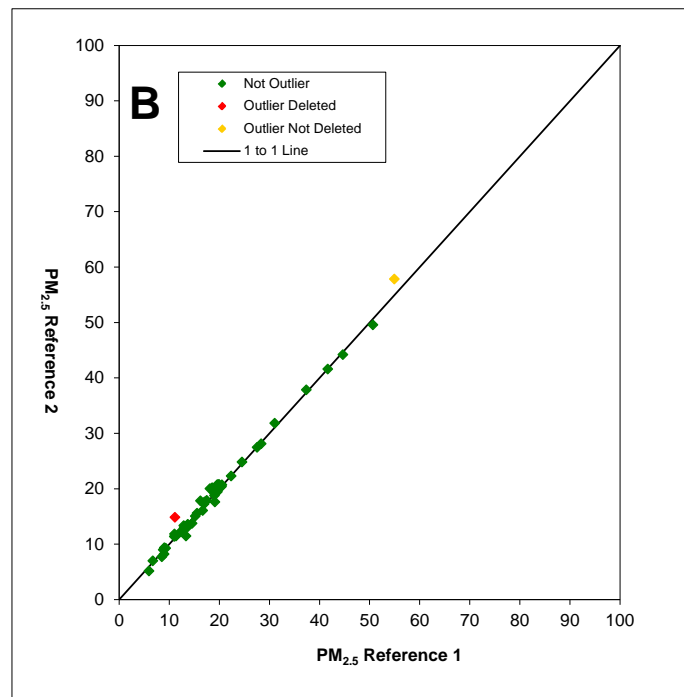
Graph Number	Site	Sampler	Number of data-pairs	Maximum Number that can be deleted	Number Identified	Number Deleted	Number of data-pairs remaining
A	Bornheim Winter	PM <sub>2.5</sub> Reference	41	1	0	0	41
B	Cologne Winter	PM <sub>2.5</sub> Reference	49	1	2	1	48
C	Bornheim Summer	PM <sub>2.5</sub> Reference	87	2	0	0	87
D	Teddington Summer	PM <sub>2.5</sub> Reference	66	2	1	1	65

Report on the suitability test of the ambient air quality measuring system  
Model 5014i Beta with PM<sub>2.5</sub> pre-separator of the company Thermo Fisher  
Scientific for the component suspended particulate matter PM<sub>2.5</sub>,  
Report No.: 936/21209885/H

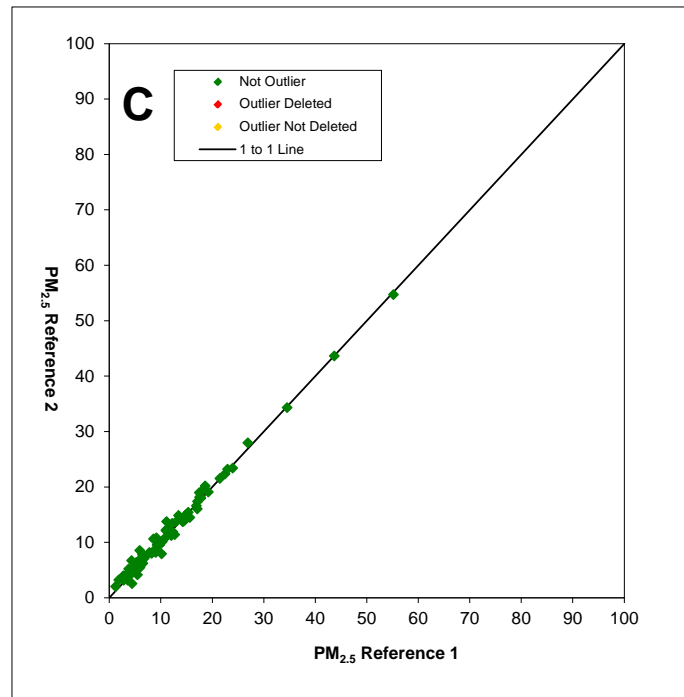
The following paired values were discarded:

**Table 14:** Discarded reference PM<sub>2.5</sub> paired values according to Grubbs

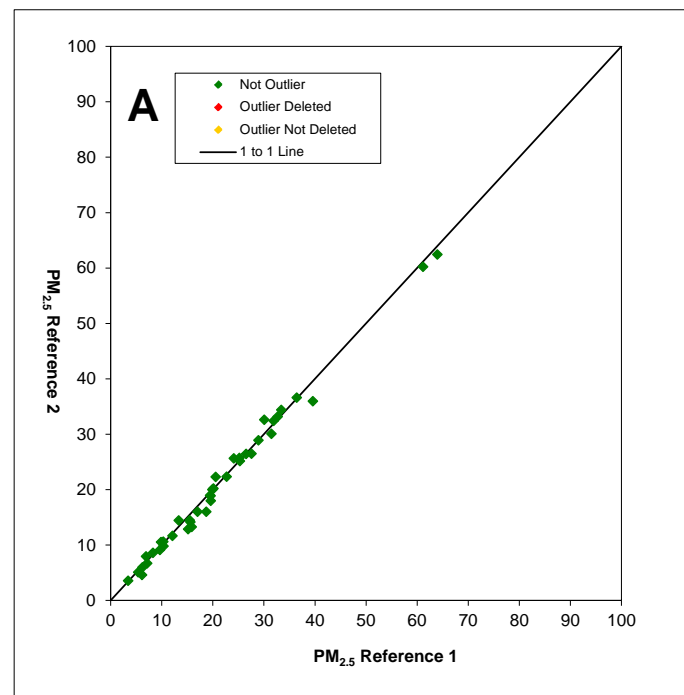
Test site	Date	Reference 1 [µg/m <sup>3</sup> ]	Reference 2 [µg/m <sup>3</sup> ]
Cologne (Winter)	05 May 2011	11.2	14.8
Teddington (summer)	03 Aug 2012	5.5	4.6



**Figure 23:** Grubbs test results for the PM<sub>2.5</sub> reference method, Cologne (winter)



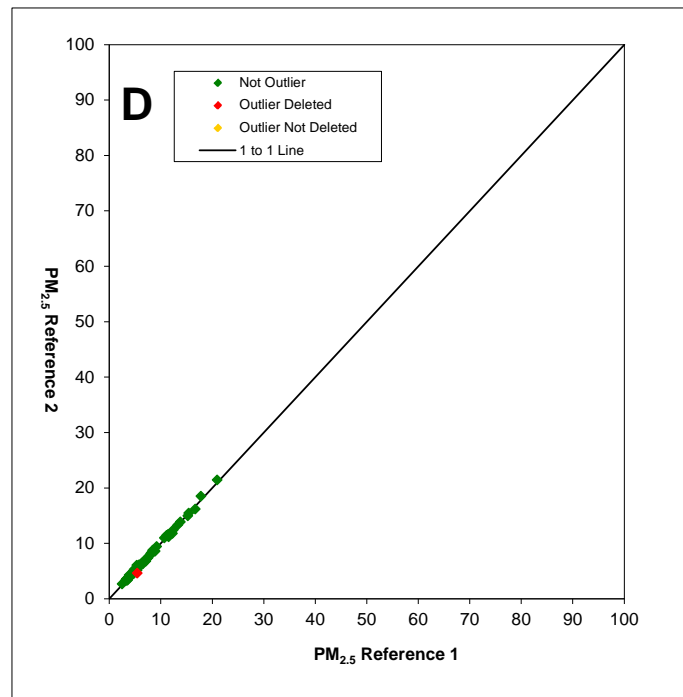
**Figure 24:** Grubbs test results for the PM<sub>2.5</sub> reference method, Bornheim (summer)



**Figure 25:** Grubbs test results for the PM<sub>2.5</sub> reference method, Bornheim (winter)



Report on the suitability test of the ambient air quality measuring system  
Model 5014i Beta with PM<sub>2.5</sub> pre-separator of the company Thermo Fisher  
Scientific for the component suspended particulate matter PM<sub>2.5</sub>,  
Report No.: 936/21209885/H



**Figure 26:** Grubbs test results for the PM<sub>2.5</sub> reference method, Teddington (summer)

### Filter handling – Mass determination

The following filters were used for suitability testing:

**Table 15:** Used filter materials

Measuring instrument	Filter material, type	Manufacturer
Reference instrument LVS3	Emfab™, Ø 47 mm	Pall

The filter material Emfab™ (Teflon-coated glass fibre filters) was used during the “Combined MCERTS and TÜV PM Equivalence Testing“ programme by special request of our British partners, because according to [8], they consider it most appropriate for the measurement task.

The handling of filters meets the requirements of EN 14907.

The procedures for filter handling and weighing are described in detail in Appendix 2 of this report.

## 5. Reference measuring methods

In accordance with the specifications of EN 14907, the following instruments were used during the field test:

### 1. Reference equipment for PM<sub>2.5</sub>:

Low-Volume Sampler LVS3

Manufacturer: Ingenieurbüro Sven Leckel, Leberstraße 63, Berlin  
Germany

Date of manufacture: 2007

PM<sub>2.5</sub> Sampling inlet

Two PM<sub>2.5</sub> reference instruments were operated simultaneously during the test, each with a controlled volume flow of 2.3 m<sup>3</sup>/h. The accuracy of the volume flow control is <1 % of the nominal volume flow under real operating conditions.

The sampling air for the LVS3 is sucked in through the sampling inlet by a rotary vane vacuum pump. The sampling air volume flow is measured between the filter and the vacuum pump with a measuring orifice. The suctioned air streams then out of the pump passing through a separator for abrasion of the rotary vane towards the air outlet.

The electronic measuring equipment displays the inlet sampling air volume in standard or operating m<sup>3</sup> as soon as the sampling is complete.

To determine the PM<sub>2.5</sub> concentration, the laboratory performed a gravimetric determination of the amount of suspended particulate matter on the respective filters. The obtained result was then divided by the respective volume of sampling air in operating m<sup>3</sup>.

## **6. Test results**

### **6.1 4.1.1 Measured value display**

*The measuring system shall be fitted with a measured value display.*

### **6.2 Equipment**

No additional equipment is required.

### **6.3 Performance of test**

It was checked whether the measuring system has a display for measured values.

### **6.4 Evaluation**

The measuring system has a display for measured values. The main screen displays the current PM concentration at all times. From here, it is easy to select the screens displaying the ambient conditions, the flow conditions and the mass sensor data using the arrow keys ↑↓.

### **6.5 Assessment**

The measuring system is fitted with a measured value display.

Minimum requirement fulfilled? yes

## 6.6 Detailed presentation of test results

Figure 27 shows the user interface with the current concentration values.



**Figure 27:** Display of the measured concentration

## **6.1 4.1.2 Easy maintenance**

*Necessary maintenance for the measuring systems should be possible without larger effort, if possible from outside.*

## **6.2 Equipment**

No additional equipment required.

## **6.3 Performance of test**

Necessary regular maintenance works were carried out according to the instructions of the manual.

## **6.4 Evaluation**

The following maintenance works must be performed by the user:

1. Check of system status:  
The system status can be monitored and controlled directly on the system itself or online.
2. In general, the sampling inlet must be cleaned according to the manufacturer's instructions while taking into account the local suspended particle concentrations (during suitability test every 4 weeks).
3. Inspection of filter tape supply – one filter tape is enough for approx. 650 filter tape changes per roll (approx. 215 days at cycles of 8 hours). Semi-annual filter tape changes are expected to be sufficient under normal conditions (no unscheduled filter changes due to significantly high dust concentrations). The "Filter Tape Counter" function allows for monitoring the current number of filter tape changes as well as configuring alarm thresholds which remind the user of upcoming changes.
4. An inspection of the sensors for ambient temperature and ambient pressure shall be carried out every three months according to the manufacturer's specifications.
5. A flow rate check must be performed every three months according to the manufacturer's specifications.
6. The system's leak tightness shall be inspected every three months according to the manufacturer's specifications.
7. The external pump exhaust filter shall be exchanged every six months.
8. As part of an annual basic maintenance, the carbon vanes of the vacuum pump shall be exchanged once a year. Furthermore, it is recommended to carry out a yearly inspection and, if required, a re-calibration of the radiometric measurement using the foil set.
9. The cleaning of the sampling tube shall be paid attention to during the annual basic maintenance.

The instructions of the manual (chapters 4 and 5) shall be observed when performing maintenance works. In general, all works can be carried out with commonly available tools.

## **6.5 Assessment**

Maintenance works can be carried out with commonly available tools taking reasonable time and effort. The semi-annual filter tape change and the works described in points 7ff are to be performed while the system is on standstill only. These works come up every six or twelve months. In the meantime, maintenance works are limited to the check of contaminations, plausibility checks and possible status/error messages.

Minimum requirement fulfilled? yes

## **6.6 Detailed presentation of test results**

The maintenance works were carried out during the test in accordance with the instructions given in the manual. No problems were noticed while following the described procedures. All maintenance works could be performed smoothly with customary tools.

## **6.1 4.1.3 Functional check**

*If the operation or the functional check of the measuring system requires particular instruments, they shall be considered as part of the measuring system and be applied in the corresponding sub-tests and included in the assessment.*

*Test gas units included in the measuring system shall indicate their operational readiness to the measuring system by a status signal and shall provide direct as well as remote control via the measuring system.*

## **6.2 Equipment**

Manual, zero filter and span foil set.

## **6.3 Performance of test**

The system status is constantly monitored and problems are indicated by a series of different warning messages. Parameters which are relevant for a proper functioning of the measuring system (e.g. flow rates, pump vacuum) can also be reviewed on the instrument itself and/or recorded continuously by a data logger.

Furthermore, it is possible to check the zero point of the measuring system externally. For this, a zero filter is installed at the device inlet. The use of this filter allows the provision of particle-free air.

During the test, the position of the zero point was determined approx. every 4 weeks using a zero filter.

In order to check the stability of the beta measurement, the “mass transfer standard” foil set is required. This set comprises one null foil and two span foils. The null foil has the same approximate mass as a clean filter spot and the span foil is a calibrated mass increase above the null foil. Therefore, the foils come in a set and must not be mixed with other sets. The foil set is used for determining mass only.

A comparison campaign was carried out once at the beginning and once at the end of the test in order to determine the mass coefficient.

## **6.4 Evaluation**

All instrument functions listed in the manual are available and can be activated. The current system status is monitored continuously and problems are indicated by a series of different warning messages.

An external check of the zero point using a zero filter is possible at any time. A check of the radiometric measurement using the “mass transfer standard” foil set can also be performed anytime.



## **6.5 Assessment**

All system functions listed in the manual are available, can be activated and function well. The current system status is continuously monitored and displayed by a series of status messages.

The results of the external zero checks performed with a zero filter during the field tests as well as the results of the regular mass coefficient checks can be found in Section 6.1

5.3.12 Long-term drift of this report.

Minimum requirement fulfilled? yes

## **6.6 Detailed presentation of test results**

Please refer to Section 6.1      5.3.12 Long-term drift

## **6.1 4.1.4 Set-up times and warm-up times**

*The set-up times and warm-up times shall be specified in the instruction manual.*

## **6.2 Equipment**

A clock was required for this test.

## **6.3 Performance of test**

The AMS were put into operation in accordance with the manufacturer's description. The necessary set-up and warm-up times were recorded separately.

Constructional measures undertaken prior to the measurement, such as the opening of an inlet through the cabinet roof, were not taken into account for evaluation.

## **6.4 Evaluation**

The set-up time comprises the time needed for all necessary works from system installation to start-up.

The measuring system must be protected from weather inconsistencies, e.g. in an air-conditioned measuring cabinet. Moreover, extensive on-site construction work is required in order to lead the sampling tube through the roof of a measuring cabinet. A non-stationary application is therefore only to be undertaken together with the associated peripheral devices.

The following steps are strictly necessary for the installation of the measuring device:

- Unpacking and installation of the measuring system (in a rack or on a bench)
- Installation of the sampling tube, dynamic heating system and PM<sub>2.5</sub> sampling inlet
- Connection of the pump
- Fitting of the ambient temperature sensor (near the sampling inlet)
- Set-up of all connecting and control lines
- Connection of power supply
- Optional: Connection of peripheral recording and control systems (data logger, PC with iPort) to the respective ports
- Switch-on of the measuring system
- Set-up of filter tape

The time it takes to perform these works makes up the set-up time. In this case, it amounts to approx. 1 hour.

The warm-up time is the time between the start of operation of the measuring system and the point when it is ready for measurement.

After switching on the system, the system is in the equilibration phase until the BETA detector has adjusted to the ambient conditions. This phase has a duration of at least 12 hours. After the equilibration phase, the following actions are necessary for starting operation the first time:

- Check of system settings with regard to flow, heating, filter tape parameters, recording of measured values, date and time
- Check and, if required, adjustment of the temperature sensors (ambient temperature, flow temperature)
- Check and, if required, adjustment of the ambient air pressure measurement
- Check and, if required, adjustment of the flow rate
- Leak test
- If necessary, check of the radiometric mass determination – calibration with mass foils

Duration: approx. 1 hour

In case of restarting operation after a short downtime, e.g. after a power outage, the above mentioned steps can be omitted with exception of a check of the system parameters, a plausibility test of the sensor values and an inspection of possible status/error messages.

If required, potential changes in the basic parameterisation of the measuring instrument can likewise be performed in just a few minutes by staff familiarised with the instruments.

## 6.5 Assessment

The set-up and warm-up times were determined.

The measuring system can be operated at different measurement sites with manageable effort. The set-up time is approximately 1 hour and the warm-up time takes a minimum of approx. 12 hours after the measuring system has adjusted to ambient conditions.

Minimum requirement fulfilled? yes

## 6.6 Detailed presentation of test results

Not required for this test.

## **6.1 4.1.5 Instrument design**

*The instruction manual shall include specifications of the manufacturer regarding the design of the measuring system. The main elements are:*

*Instrument shape (e.g. bench mounting, rack mounting, free mounting)*

*Mounting position (e.g. horizontal or vertical mounting)*

*Safety requirements*

*Dimensions*

*Weight*

*Power consumption*

## **6.2 Equipment**

A power consumption measuring instrument and a scale were used for this test.

## **6.3 Performance of test**

The installation of the delivered instruments was compared with the description given in the manuals. The specified power consumption was determined for a period of 24 h under normal operating conditions during field test.

## **6.4 Evaluation**

The measuring system must be installed in horizontal mounting position (e.g. on a bench or a rack) protected from weather inconsistencies. The temperature at the installation site shall be within the range of 5 °C to 40 °C with a relatively low amount of temperature fluctuation (no direct sunlight, no direct exposure to heater or air conditioner).

The dimensions and weights of the measuring system conform to the specifications in the manual.

The power consumption of the measuring system and pump is specified by the manufacturer as a maximum of approx. 880 W. During a 24-hour test, these specifications were checked. At no time the mentioned value was exceeded during these investigations.

## **6.5 Assessment**

The instrument design specifications listed in the operating manual are complete and correct.

Minimum requirement fulfilled? yes

## **6.6 Detailed presentation of test results**

Not required for this test.

#### **6.1 4.1.6 Unintended adjustment**

*It shall be possible to secure the adjustment of the measuring system against illicit or unintended adjustment during operation.*

#### **6.2 Equipment**

No additional equipment required.

#### **6.3 Performance of test**

The measuring system is operated using the front panel pushbuttons and LCD display.

A change of the parameters or the adjustment of sensors is only possible by pressing several key sequences.

The measuring system can also be password protected. If a password protection is activated (lock icon), it is still possible to see data, parameters and settings on the front panel user interface. It is, however, not possible to perform any changes.

As an outside installation of the measuring device is not possible, additional protection is given by installation at locations, to which unauthorised people have no access (e.g. locked measuring cabinet).

#### **6.4 Evaluation**

Unintended and unauthorised adjustment of instrument parameters can be avoided by password protection. Even without password protection, the adjustment of sensors and change of the parameters can only be done by pressing several key sequences. Moreover, additional protection against unauthorised intervention is given by installing the system in a locked measuring cabinet.

#### **6.5 Assessment**

The AMS is protected against unauthorised and unintended adjustment. In addition, the AMS shall be locked up in a measuring cabinet.

Minimum requirement fulfilled? yes

#### **6.6 Detailed presentation of test results**

Not required for this test.

## **6.1 4.1.7 Data output**

*The output signals shall be provided digitally (e.g. RS232) and/or as analogue signals (e.g. 4 mA to 20 mA).*

## **6.2 Equipment**

PC with "iPort" software.

## **6.3 Performance of test**

The test was carried out using a PC with the software "iPort"(via Ethernet).

The AMS was connected to a PC via Ethernet and the data were downloaded.

The AMS also offers the possibility of outputting analogue signals and measured signals or communicating via serial interface RS 232/RS 485.

## **6.4 Evaluation**

The measured signals are offered as follows at the rear side of the instrument:

Analogue:	0-0.1, 0-1, 0-5 and 0-10 V	selectable concentration range
	0-20 or 4-20 mA	selectable concentration range

Digital:	Ethernet with "iPort" software
	RS 232 / RS 485 interface

## **6.5 Assessment**

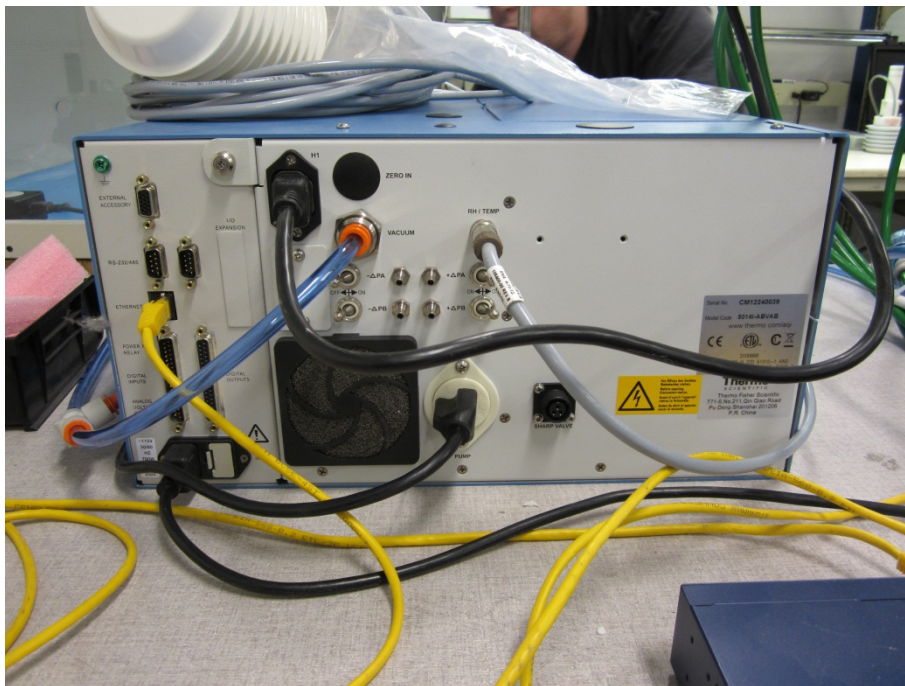
Measured signals are output as analogue signals (in V or mA) and digitally (via Ethernet, RS 232, RS 485).

The connection of additional measuring and peripheral devices to the respective ports of the devices is possible (e.g. analogue inputs).

Minimum requirement fulfilled? yes

## 6.6 Detailed presentation of test results

Figure 28 shows a view of the rear side of the instrument with the respective measured value outputs.



**Figure 28:** Rear view of Model 5014i Beta

## **6.1 5.1 General**

*The manufacturer's specifications in the instruction manual shall be by no means better than the results of the performance test.*

## **6.2 Equipment**

No additional equipment required.

## **6.3 Performance of test**

The test results were compared with the specifications of the manual.

## **6.4 Evaluation**

Deviations found on the first draft of the manual from the actual design were cleared.

## **6.5 Assessment**

No differences between the instrument design and the descriptions given in the manual were detected.

Minimum requirement fulfilled? yes

## **6.6 Detailed presentation of test results**

Please refer to Section 6.4 of this module.



## 6.1 5.2.1 Certification ranges

*The certification range intended for testing shall be determined.*

## 6.2 Equipment

No additional equipment required.

## 6.3 Performance of test

The certification range intended for testing shall be determined.

## 6.4 Evaluation

Standard VDI 4202, Part 1 contains the following minimum requirements on certification ranges for systems measuring suspended particulate matter in ambient air:

**Table 16:** Certification ranges

Measured component	Lower limit of CR	Upper limit of CR	Limit value	Evaluation period
	in µg/m <sup>3</sup>	in µg/m <sup>3</sup>	in µg/m <sup>3</sup>	
PM <sub>2.5</sub>	0	50	25	Calendar year

The certification ranges are related to the limit value with the shortest assessment period and used for the assessment of the measuring system in the range of the limit value. This assessment of the measuring system in the range of the limit value is performed as part of the determination of the expanded uncertainty of the candidates according to Guide [4]. For this purpose, the following values are used as reference values in accordance with the specifications of the guide:

PM<sub>2.5</sub>: 30 µg/m<sup>3</sup>

Reference is made to test point 6.1 5.4.10 Calculation of the expanded uncertainty of the instruments of this report.

## 6.5 Assessment

It is possible to assess the measuring system in the range of the relevant limit values.

Minimum requirement fulfilled? yes

## 6.6 Detailed presentation of test results

Please refer to test point 6.1 5.4.10 Calculation of the expanded uncertainty of the instruments of this report.

## **6.1 5.2.2 Measuring range**

*The upper limit of the measuring range shall be greater or equal to the upper limit of the certification range.*

## **6.2 Equipment**

No additional equipment required.

## **6.3 Performance of test**

It was tested, whether the upper limit of the measuring range of the measuring system is greater or equal to the upper limit of the certification range.

## **6.4 Evaluation**

As a standard, a measuring range of 0 – 10 000 µg/m<sup>3</sup> is adjusted on the measuring system. As appropriate default setting of the analogue output for European conditions a measuring range of 0 – 200 or 0 – 1000 µg/m<sup>3</sup> is recommended.

(Recommended) measuring range: 0 – 200 or 0 – 1000 µg/m<sup>3</sup>

Upper limit of the certification range: PM<sub>2.5</sub>: 50 µg/m<sup>3</sup>

## **6.5 Assessment**

A measuring range of 0 – 10 000 µg/m<sup>3</sup> is set by default. It is possible to adjust other measuring ranges.

The upper limit of the measuring range of the measuring system is greater than the respective upper limit of the certification range.

Minimum requirement fulfilled? yes

## **6.6 Detailed presentation of test results**

Not required for this test.

## **6.1 5.2.3 Negative output signals**

*Negative output signals or measured values may not be suppressed (life zero).*

## **6.2 Equipment**

No additional equipment required.

## **6.3 Performance of test**

The AMS was tested on its ability to display negative output signals in the laboratory and in the field.

## **6.4 Evaluation**

The AMS can display negative values both on the front panel and over data outputs.

## **6.5 Assessment**

Negative measured signals are displayed directly on the AMS and are transmitted correctly via the respective signal outputs of the measuring system.

Minimum requirement fulfilled? yes

## **6.6 Detailed presentation of test results**

Not required for this test.

## **6.1 5.2.4 Failure in the mains voltage**

*In case of malfunction of the measuring system or failure in the mains voltage for a period of up to 72 h, uncontrolled emission of operation and calibration gas shall be avoided. The instrument parameters shall be secured by buffering against loss caused by failure in the mains voltage. When mains voltage returns, the instrument shall automatically reach the operation mode and start the measurement according to the operating instructions.*

## **6.2 Equipment**

Not additional equipment required.

## **6.3 Performance of test**

A failure in the mains voltage was simulated and it was tested, whether the instrument remains undamaged and is ready for measurement after restart of the power supply.

## **6.4 Evaluation**

Since the measuring systems need neither operation nor calibration gases an uncontrolled escape of gases is not possible.

In case of a failure in the mains voltage, the measuring system resumes operation automatically. However, at least the first 12 h worth of data after voltage returns shall be discarded, since the system needs an equilibration phase after restart until the BETA detector adjusts to ambient conditions (see point 6.1 4.1.4 Set-up times and warm-up times).

## **6.5 Assessment**

All instrument parameters are protected against loss through buffering. After the power supply has returned, the measuring device goes back to failure-free operational condition and resumes measurement. However, at least the first 12 h worth of data after voltage returns shall be discarded, since the system needs an equilibration phase after restart until the BETA detector adjusts to ambient conditions.

Minimum requirement fulfilled? yes

## **6.6 Detailed presentation of test results**

Not required for this test.

## 6.1 5.2.5 Operating states

*The measuring system shall allow the control of important operating states by telemetrically transmitted status signals.*

## 6.2 Equipment

PC for data acquisition.

## 6.3 Performance of test

A PC was connected locally via Ethernet to the AMS and the transfer of data including system status was tested.

Furthermore, it is possible to monitor and operate the instrument via serial interface.

It is also easy to monitor and operate the AMS remotely with an appropriate router or modem.

## 6.4 Evaluation

The measuring system enables an extensive telemetric control and operation in a variety of ways (Ethernet, RS232, RS485).

## 6.5 Assessment

The measuring systems can be extensively monitored and operated from an external PC via modem or router.

Minimum requirement fulfilled? yes

## 6.6 Detailed presentation of test results

Not required for this test.

## **6.1 5.2.6 Switch-over**

*Switch-over between measurement and functional check and/or calibration shall be possible telemetrically by computer control or manual intervention.*

## **6.2 Equipment**

No additional equipment required.

## **6.3 Performance of test**

The AMS can be monitored and partly operated by the user directly on the instrument or via telemetric remote control.

Some functions, e.g. performing a span foil test for checking the mass coefficient of the radiometric measurement, can only be activated directly on the instrument.

## **6.4 Evaluation**

All operating procedures that do not require practical work on site can be monitored by the user directly on the instrument as well as by telemetric remote control.

## **6.5 Assessment**

In principle, all necessary operations for performing a functional check can be monitored directly on the system or via telemetric remote control.

Minimum requirement fulfilled? yes

## **6.6 Detailed presentation of test results**

Not required for this test.

## **6.1 5.2.7 Maintenance interval**

*The maintenance interval of the measuring system shall be determined during the field test and specified. The maintenance interval should be three months, if possible, but at least two weeks.*

## **6.2 Equipment**

No additional equipment required.

## **6.3 Performance of test**

This test was carried out in order to determine, which maintenance procedures are required at which period to maintain the correct functionality of the measuring system. Furthermore, the results of the zero and span drift test described in point 6.1 5.3.12 Long-term drift were taken into account for the determination of the maintenance interval.

## **6.4 Evaluation**

No drifts beyond the permissible limits were detected during the entire field test period. Therefore, the maintenance interval is determined by the specified maintenance procedures (see module 4.1.2).

During operation, the maintenance works can be limited to checks of contamination, plausibility and status/error messages.

## **6.5 Assessment**

The maintenance interval is defined by the necessary maintenance procedures and has been set to 1 month.

Minimum requirement fulfilled? yes

## **6.6 Detailed presentation of test results**

The necessary maintenance works can be found in module 4.1.2 of this report and in chapter 5 of the instruction manual.

## **6.1 5.2.8 Availability**

*The availability of the measuring system shall be determined during the field test and shall be at least 95 %.*

## **6.2 Equipment**

No additional equipment required.

## **6.3 Performance of test**

The start and end times of the availability tests were defined by the start and end of the field tests at each test site. All measurement interruptions, e.g. due to system failures or maintenance works, were taken into account.

## **6.4 Evaluation**

Table 17 and Table 18 show a summary of the operation, maintenance and malfunction times. The measuring systems were operated over a period of 313 measurement days (see annex 5). This period includes a total of 22 days of zero filter operation, audits and days, which had to be rejected due to the change to zero filter (see annex 5).

Outages caused by external influences, which cannot be attributed to the devices themselves, were recorded on 10 March 2011 and 14 March 2011 (power outage). Since the AMS needs some hours for stabilising, one day following the outages had to be discarded as well. Furthermore, SN 1 was switched off inadvertently on 26 April 2011. Therefore, both the 26 and 27 April 2011 could not be evaluated. An unintended switch-off of SN 1 was also recorded on 3 May 2011. This time, the system was down for a very short time, so that the data of the following day did not have to be discarded. On this account, the total operating time is reduced to 306 days for SN 1 and 309 days for SN 2.

The systems presented the following malfunctions:

SN 1:

A malfunction of SN 1 was observed on 8 August 2012 at the test site Teddington (summer). It was, however, not noticed directly and the staff on site could not identify its cause. Troubleshooting was also delayed due to vacation of the staff and the associated communication problems. For this reason, the measuring system could only be brought back to normal operation on 6 September 2012. The cause of the failure was a faulty pressure sensor.

The long outage period cannot only be attributed to the measuring system itself, since the identification and troubleshooting of such a problem by the staff is usually performed within a week. Therefore, this outage was taken up in the evaluation with a duration of 8 days.

SN 2:

SN 2 presented a malfunction of the nephelometer (see test report 936/21209885/F, 20 September 2013) at the test site Bornheim (summer). The system had to be repaired, for which the values measured from 28 July 2011 to 4 August 2011 had to be discarded.

On 9 August 2011, a failure of the filter tape was observed. The cause was not identified.

No further malfunctions of the instruments were observed.

The customary maintenance works (not including zero filter operation), e.g. maintenance of the sampling inlet and check of flow rate / leak tightness, generally do not take more than approx. 1 h per day. For this reason, the pertaining daily averages were not discarded.

## **6.5 Assessment**

The availability was 97.4 % for SN 1 and 97.1 % for SN 2 without test-related outages, or 90.2 % for SN 1 and 90.0 % for SN 2 including test-related outages.

Minimum requirement fulfilled?  yes



## 6.6 Detailed presentation of test results

**Table 17:** Determination of availability (without test-related outages)

		System 1 (SN 1)	System 2 (SN 2)
Operating time	d	306	309
Outage time	d	8	9
Maintenance	d	0	0
Actual operating time	d	298	300
Availability	%	97.4	97.1

**Table 18:** Determination of availability (including test-related outages)

		System 1 (SN 1)	System 2 (SN 2)
Operating time	d	306	309
Outage time	d	8	9
Maintenance incl. zero filter operation	d	22	22
Actual operating time	d	276	278
Availability	%	90.2	90.0

## **6.1 5.2.9 Instrument software**

*The version of the instrument software to be tested shall be displayed during switch-on of the measuring system. The test institute shall be informed on changes in the instrument software, which have influence on the performance of the measuring system.*

## **6.2 Equipment**

No additional equipment required.

## **6.3 Performance of test**

It was tested, whether the instrument software version can be displayed on the instrument. The manufacturer was made aware that any change to the instrument software must be reported to the test institute.

## **6.4 Evaluation**

The current software version is not displayed on the instrument during switch-on. It can, however, be reviewed at any time by selecting the menu "Diagnostics", item "Program Versions".

The test started in the year 2009 with the software version V00.05.41.114. The software was steadily enhanced and optimised during the course of testing.

At the beginning of the field test in January 2011, software version V01.00.01.197 was implemented. This version was used during the whole field test.

The software was updated to version V01.00.03.225 after conclusion of the regular field test and before starting the remaining laboratory tests. This software version was as well installed during the additional comparison campaign "Bornheim, summer 2013.

In the meantime the software version was set to the current version V02.00.00.232+ due to a discontinuation of a processor board.

An overview of software changes can be found in Section 4.1 General.

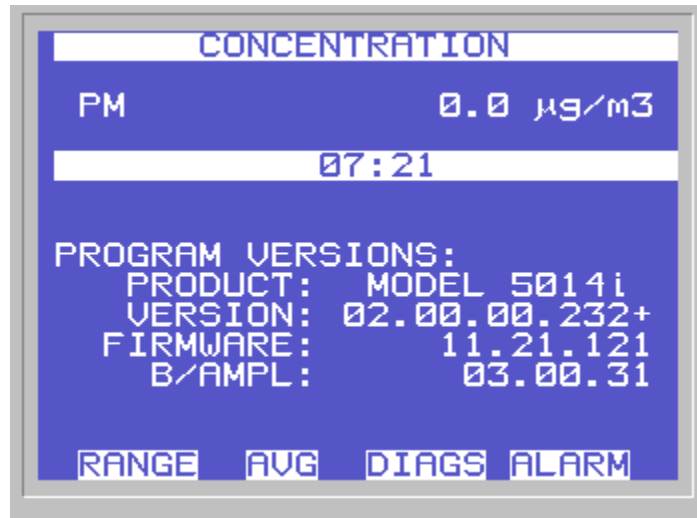
The reliability of the AMS was consistently increased with every change. The changes introduced up to version V02.00.00.232+ are not expected to affect the performance of the AMS significantly.

## **6.5 Assessment**

The version of the instrument software is shown on the display. Changes to the instrument software are communicated to the test institute.

Minimum requirement fulfilled? yes

## 6.6 Detailed presentation of test results



**Figure 29:** Software version (here V02.00.00.232+) displayed by selection of the menu “Diagnostics / Program Versions”

**Note:**

The subordinate software versions FIRMWARE (general parameters of the i-series) and B/AMPL (beta / amplifier) listed in the software display above are fixed main software components. Changes to the subordinate programmes FIRMWARE (general parameters of the i-series) and B/AMPL (beta / amplifier) are necessarily bound to a change in the main software.



## **6.1 5.3.1 General**

*The test is based on the minimum requirements of Standard VDI 4202 Part 1 (September 2010).*

## **6.2 Equipment**

No additional equipment required.

## **6.3 Performance of test**

The test is based on the minimum requirements of Standard VDI 4202, Part 1 (September 2010).

## **6.4 Evaluation**

Standard VDI 4202, Part 1 and VDI 4203, Part 3 were republished after an extensive revision with latest update September 2010. Unfortunately, after this revision uncertainties and contradictions remain regarding the concrete minimum requirements on the one hand, and the general relevance of the test points on the other hand when testing particulate ambient air measuring devices. The following test points require clarification:

6.1 5.3.2 Repeatability standard deviation at zero point

no minimum requirement defined

6.1 5.3.3 Repeatability standard deviation at reference point

not relevant for particulate devices

6.1 5.3.4 Linearity (lack of fit)

not relevant for particulate devices

6.1 5.3.7 Sensitivity coefficient of surrounding temperature

no minimum requirement defined

6.1 5.3.8 Sensitivity coefficient of supply voltage

no minimum requirement defined

6.1 5.3.11 Standard deviation from paired measurement

no minimum requirement defined

6.1 5.3.12 Long-term drift

no minimum requirement defined

6.1 5.3.13 Short-term drift

not relevant for particulate devices

6.1 5.3.18 Overall uncertainty

not relevant for particulate devices

For this reason an official request to the competent German body was made, to define a co-ordinated procedure for dealing with inconsistencies in the Standard.

Report on the suitability test of the ambient air quality measuring system  
Model 5014i Beta with PM<sub>2.5</sub> pre-separator of the company Thermo Fisher  
Scientific for the component suspended particulate matter PM<sub>2.5</sub>,  
Report No.: 936/21209885/H

Page 97 of 417

The following procedure was suggested:

Test points 5.3.2, 5.3.7, 5.3.8, 5.3.11 and 5.3.12 are evaluated as before basing on the minimum requirements stated in VDI 4202 Part 1 of 2002 (i.e. using the reference values B<sub>0</sub>, B<sub>1</sub> and B<sub>2</sub>).

The performance of the test points 5.3.3, 5.3.4, 5.3.13 and 5.3.18 is omitted, as they are not relevant for particulate measuring devices.

The competent German body agreed with the proposed procedure by decisions of 27 June 2011 and 07 October 2011.

## **6.5 Assessment**

The test is based on the minimum requirements of Standard VDI 4202, Part 1 (September 2010). Test points 5.3.2, 5.3.7, 5.3.8, 5.3.11 and 5.3.12 are evaluated as before basing on the minimum requirements stated in VDI 4202 Part 1 of 2002 (i.e. using the reference values B<sub>0</sub>, B<sub>1</sub> and B<sub>2</sub>). The performance of the test points 5.3.3, 5.3.4, 5.3.13 and 5.3.18 is omitted, as they are not relevant for particulate measuring devices.

Minimum requirement fulfilled? yes

## **6.6 Detailed presentation of test results**

Not required for this test.

## 6.1 5.3.2 Repeatability standard deviation at zero point

*The repeatability standard deviation at zero point shall not exceed the requirements of Table 2 in the certification range according to Table 1 of Standard VDI 4202 Part 1 (September 2010).*

*In case of deviating certification ranges, the repeatability standard deviation at zero point shall not exceed 2% of the upper limit of this certification range.*

Note:

This item cannot be evaluated according to the current versions of Standards VDI 4202 Part 1 (September 2010) and VDI 4203 Part 3 (September 2010) when testing particulate measuring systems, due to the fact that a minimum requirement has not been defined. By resolution of the competent German body (see module 5.3.1), reference is made to the following requirement in the previous version of Standard VDI 4202 Part 1 (June 2002):

*The detection limit of the measuring system shall be smaller or equal to reference value  $B_0$ . The detection limit shall be determined in the field.*

## 6.2 Equipment

Zero filter for testing the zero point.

## 6.3 Performance of test

The detection limit is determined for candidates SN 1 and SN 2 by operating the devices with the respective zero filters installed at the inlets of both measuring systems. Sampling air free of suspended particulate matter was offered over a period of 15 days, for a duration of 24 h a day. The determination of the detection limit was done in the laboratory, since the provision of particulate-free air for such a long time was not possible under field conditions.

## 6.4 Evaluation

The detection limit  $X$  is determined from the standard deviation  $s_{x_0}$  of the Beta measured values by applying particulate-free sampling air to both candidates. It corresponds to the standard deviation of the average  $\bar{x}_0$  of the measured values  $x_{0i}$  of each candidate multiplied with the Students factor:

$$X = t_{n-1;0.95} \cdot s_{x_0} \quad \text{where } s_{x_0} = \sqrt{\frac{1}{n-1} \cdot \sum_{i=1,n} (x_{0i} - \bar{x}_0)^2}$$

Reference value:  $B_0 = 2 \mu\text{g}/\text{m}^3$

## 6.5 Assessment

The investigations result in detection limits of 1.77 µg/m<sup>3</sup> for system 1 (SN 1) and 2.25 µg/m<sup>3</sup> for system 2 (SN 2).

Minimum requirement fulfilled? yes

## 6.6 Detailed presentation of test results

**Table 19:** Detection limit PM<sub>2.5</sub>

		System SN 1	System SN 2
Number of values n		15	15
Mean of the zero values $\bar{x}_0$	µg/m <sup>3</sup>	1.94	2.72
Standard deviation of values $s_{x_0}$	µg/m <sup>3</sup>	0.82	1.05
Students Factor $t_{n-1;0.95}$		2.14	2.14
Detection limit X	µg/m <sup>3</sup>	<b>1.77</b>	<b>2.25</b>

Single values from the determination of the detection limit can be looked up in annex 1 of the appendix.

### **6.1 5.3.3 Repeatability standard deviation at reference point**

*The repeatability standard deviation at reference point shall not exceed the requirements of Table 2 in the certification range according to Table 1 of Standard VDI 4202 Part 1 (September 2010). The limit value or the alert threshold shall be used as reference point.*

*In case of deviating certification ranges, the repeatability standard deviation at reference point shall not exceed 2% of the upper limit of this certification range. In this case a value  $c_t$  at 70% to 80% of the upper limit of this certification range shall be used as reference point.*

Note:

By resolution of the competent German body (see module 5.3.1), this test is not relevant for particulate measuring systems.

### **6.2 Equipment**

Not applicable.

### **6.3 Performance of test**

Not applicable.

### **6.4 Evaluation**

Not applicable.

### **6.5 Assessment**

Not applicable.

Minimum requirement fulfilled? -

### **6.6 Detailed presentation of test results**

Not applicable.



## 6.1 5.3.4 Linearity (lack of fit)

*The analytical function describing the relationship between the output signal and the value of the air quality characteristic shall be linear.*

*Reliable linearity is given, if deviations of the group averages of measured values about the calibration function meet the requirements of Table 2 of in the certification range according to Table 1 of Standard VDI 4202 Part 1 (September 2010).*

*For all other certification ranges the group averages of measured values about the calibration function shall not exceed 5 % of the upper limit of the corresponding certification range.*

Note:

By resolution of the competent German body (see module 5.3.1), this test is not relevant for particulate measuring systems. For PM<sub>2.5</sub> particulate measuring systems, this test shall be performed according to minimum requirement 5.4.10 "Calculation of the expanded uncertainty of the instruments".

## 6.2 Equipment

See module 5.4.10 (PM<sub>2.5</sub>)

## 6.3 Performance of test

For PM<sub>2.5</sub> particulate measuring systems, this test shall be performed according to minimum requirement 5.4.10 "Calculation of the expanded uncertainty of the instruments"

## 6.4 Evaluation

See module 5.4.10 (PM<sub>2.5</sub>)

## 6.5 Assessment

For PM<sub>2.5</sub> particulate measuring systems, this test shall be performed according to minimum requirement 5.4.10 "Calculation of the expanded uncertainty of the instruments".

Minimum requirement fulfilled? -

## 6.6 Detailed presentation of test results

See module 5.4.10 (PM<sub>2.5</sub>)

## **6.1 5.3.5 Sensitivity coefficient of sample gas pressure**

*The sensitivity coefficient of sample gas pressure at reference point shall not exceed the requirements of Table 2 of Standard VDI 4202 Part 1 (September 2010). A value  $c_t$  at 70 % to 80 % of the upper limit of the certification range shall be used as reference point.*

Note:

This test is not relevant for particulate measuring systems.

## **6.2 Equipment**

Not applicable.

## **6.3 Performance of test**

Not applicable.

## **6.4 Evaluation**

Not applicable.

## **6.5 Assessment**

Not applicable.

Minimum requirement fulfilled? -

## **6.6 Detailed presentation of test results**

Not applicable.

## 6.1 5.3.6 Sensitivity coefficient of sample gas temperature

*The sensitivity coefficient of sample gas temperature at reference point shall not exceed the requirements of Table 2 of Standard VDI 4202 Part 1 (September 2010). A value  $c_t$  at 70 % to 80 % of the upper limit of the certification range shall be used as reference point.*

Note:

This test is not relevant for particulate measuring systems.

## 6.2 Equipment

Not applicable.

## 6.3 Performance of test

Not applicable.

## 6.4 Evaluation

Not applicable.

## 6.5 Assessment

Not applicable.

Minimum requirement fulfilled? -

## 6.6 Detailed presentation of test results

Not applicable.



## 6.1 5.3.7 Sensitivity coefficient of surrounding temperature

*The sensitivity coefficient of surrounding temperature at zero and reference point shall not exceed the requirements of Table 2 of Standard VDI 4202 Part 1 (September 2010). A value  $c_i$  at 70 % to 80 % of the upper limit of the certification range shall be used as reference point.*

### Note:

This item cannot be evaluated according to the current versions of Standards VDI 4202 Part 1 (September 2010) and VDI 4203 Part 3 (September 2010) when testing particulate measuring systems, due to the fact that a minimum requirement has not been defined. By resolution of the competent German body (see module 5.3.1), reference is made to the following requirement in the previous version of Standard VDI 4202 Part 1 (June 2002):

*The temperature dependence of the measured value at zero concentration shall not exceed the reference value  $B_0$  if ambient temperature is changed by 15 K in the range of +5 °C to +20 °C or by 20 K in the range of +20 °C to +40 °C.*

*The temperature dependence of the measured value in the range of the reference value  $B_1$  shall not exceed 5 % of the measured value if ambient temperature is changed by 15 K in the range of +5 °C and +20 °C or by 20 K in the range of +20 °C and +40 °C.*

## 6.2 Equipment

Climatic chamber for a temperature range of +5 to +40 °C, zero filter for testing the zero point and span foil set for testing the span point.

## 6.3 Performance of test

In order to test the dependence of zero point and measured values on the surrounding temperature, the complete measuring systems were operated in a climatic chamber.

For the zero point test zero filters were installed at the inlets of both measuring systems SN 1 and SN 2, to which particle-free sampling air was applied.

The reference point test comprised a check of the mass coefficient in order to test the stability of the sensitivity of both candidates SN 1 and SN 2.

The devices were exposed to the following surrounding temperature sequence in the climatic chamber:

20 °C – 5 °C – 20 °C – 40 °C – 20 °C.

After an equilibration time of approx. 24 h per temperature step, the recording of measured values at zero point (3 x 24 h per temperature step) and at reference point (3 x per temperature step) started.

## 6.4 Evaluation

### Zero point:

The values measured at the concentration of the respective 24 h single measurements were read out and evaluated. The absolute deviation in µg/m<sup>3</sup> per temperature step was examined in relation to the default value at 20 °C.

Reference value:  $B_0 = 2 \mu\text{g}/\text{m}^3$

### Reference point:

The percentage change of the determined measured values for the mass coefficient was examined at each temperature step in relation to the default value at 20 °C.

It should be noted that concentration values could not be simulated by checking the mass coefficient. It was therefore not possible to examine the range of B<sub>1</sub>.

## 6.5 Assessment

The maximum dependence on surrounding temperature in the range 5 °C to 40 °C was -2.4 µg/m<sup>3</sup> at zero.

No deviation > -2.6 % of the default value at 20 °C could be observed at reference point.

Minimum requirement fulfilled? yes

## 6.6 Detailed presentation of test results

**Table 20:** Dependence of the zero point (Beta) on surrounding temperature, deviation in  $\mu\text{g}/\text{m}^3$ , average of three measurements

Temperature		Deviation	
Start temperature	End temperature	SN 1	SN 2
$^{\circ}\text{C}$	$^{\circ}\text{C}$	$\mu\text{g}/\text{m}^3$	$\mu\text{g}/\text{m}^3$
20	5	-0.9	-2.1
5	20	0.7	0.3
20	40	0.5	-0.9
40	20	-0.1	-2.4

**Table 21:** Dependence of sensitivity (mass coefficient) on surrounding temperature, deviation in %, average of three measurements

Temperature		Deviation	
Start temperature	End temperature	SN 1	SN 2
$^{\circ}\text{C}$	$^{\circ}\text{C}$	[%]	[%]
20	5	0.2	-1.3
5	20	-0.5	-2.6
20	40	2.0	-1.0
40	20	0.6	-0.5

The results of the three single measurements are presented in annexes 2 and 3 of the appendix.

## 6.1 5.3.8 Sensitivity coefficient of supply voltage

*The sensitivity coefficient of supply voltage shall not exceed the requirements of Table 2 of Standard VDI 4202 Part 1 (September 2010). A value  $c_i$  at 70 % to 80 % of the upper limit of the certification range shall be used as reference point.*

Note:

This item cannot be evaluated according to the current versions of Standards VDI 4202 Part 1 (September 2010) and VDI 4203 Part 3 (September 2010) when testing particulate measuring systems, due to the fact that a minimum requirement has not been defined. By resolution of the competent German body (see module 5.3.1), reference is made to the following requirement in the previous version of Standard VDI 4202 Part 1 (June 2002):

*The change in the measured values at reference value  $B_1$  caused by normal changes in the mains voltage in the interval (230 +15/-20) V shall not exceed  $B_0$ .*

## 6.2 Equipment

Adjustable isolating transformer and span foil set for testing the reference point.

## 6.3 Performance of test

In order to test the dependence of the measured signals on supply voltage, the voltage was reduced from 230 V to 210 V and then increased with an intermediate step of 230 V to 245 V.

The reference point test comprised a check of the mass coefficient in order to test the stability of the sensitivity of both candidates SN 1 and SN 2.

Since the AMS is not intended for mobile application, a separate check of the dependence of the measured signals on the mains frequency was omitted.

## 6.4 Evaluation

The percentage change of the determined measured values for the mass coefficient was examined at each voltage step in relation to the default value at 230 V.

It should be noted that concentration values could not be simulated by checking the mass coefficient. It was therefore not possible to examine the range of  $B_1$ .

## 6.5 Assessment

No deviations > -1.4 % in relation to the default value at 230 V caused by voltage changes could be detected for PM<sub>2.5</sub>.

Minimum requirement fulfilled? yes

## 6.6 Detailed presentation of test results

Table 22 shows a summary of the test results.

**Table 22:** Dependence of the measured values on mains voltage, deviation in %

Mains voltage		Deviation	
Start voltage	End voltage	SN 1	SN 2
V	V	[%]	[%]
230	190	-0.2	-0.7
190	230	0.3	-1.3
230	245	0.1	-0.9
245	230	-0.4	-1.4

The single values are presented in annex 4 of the appendix.



## 6.1 5.3.9 Cross-sensitivity

*The change in the measured value caused by interfering components in the sample gas shall not exceed the requirements of Table 2 of Standard VDI 4202 Part 1 (September 2010) at zero and reference point.*

Note:

This test is not relevant for particulate measuring systems. Instead, minimum requirement 5.4.5 is valid. The results of this test can be found in module 5.4.5.

## 6.2 Equipment

Not applicable.

## 6.3 Performance of test

Not applicable.

## 6.4 Evaluation

Not applicable.

## 6.5 Assessment

Not applicable.

Minimum requirement fulfilled? -

## 6.6 Detailed presentation of test results

Not applicable.

## **6.1 5.3.10 Averaging effect**

*For gaseous components the measuring system shall allow the formation of hourly averages.*

*The averaging effect shall not exceed the requirements of Table 2 of Standard VDI 4202 Part 1 (September 2010).*

Note:

This test is not relevant for particulate measuring systems.

## **6.2 Equipment**

Not applicable.

## **6.3 Performance of test**

Not applicable.

## **6.4 Evaluation**

Not applicable.

## **6.5 Assessment**

Not applicable.

Minimum requirement fulfilled? -

## **6.6 Detailed presentation of test results**

Not applicable.

## 6.1 5.3.11 Standard deviation from paired measurement

*The standard deviation from paired measurements under field conditions shall be determined with two identical measuring systems by paired measurements in the field test. It shall not exceed the requirements of Table 2 of Standard VDI 4202 Part 1 (September 2010).*

Note:

This item cannot be evaluated according to the current versions of Standards VDI 4202 Part 1 (September 2010) and VDI 4203 Part 3 (September 2010) when testing particulate measuring systems, due to the fact that a minimum requirement has not been defined. By resolution of the competent German body (see module 5.3.1), reference is made to the following requirement in the previous version of Standard VDI 4202 Part 1 (June 2002):

*The "Reproduzierbarkeit" [reproducibility]  $R_D$  of the measuring system shall be determined by parallel measurements with two identical measuring systems and shall be at least equal to 10.  $B_1$  shall be used as the reference value.*

## 6.2 Equipment

The reproducibility was determined with the auxiliary equipment described in Section 5.

## 6.3 Performance of test

Reproducibility is defined as the maximum difference between two randomly chosen single values obtained under equal conditions. This test was carried out with two identical systems operated simultaneously during the field test. All measurement data obtained during the field test was evaluated.

## 6.4 Evaluation

The reproducibility is calculated as follows:

$$R = \frac{B_1}{U} \geq 10 \quad \text{where} \quad U = \pm s_D \cdot t_{(n,0,95)} \quad \text{and} \quad s_D = \sqrt{\frac{1}{2n} \cdot \sum_{i=1}^n (x_{1i} - x_{2i})^2}$$

- $R$  = Reproducibility at  $B_1$
- $U$  = Uncertainty
- $B_1$  = 25  $\mu\text{g}/\text{m}^3$  for PM<sub>2.5</sub>
- $s_D$  = Standard deviation from paired measurements
- $n$  = No. of paired measurements
- $t_{(n,0,95)}$  = Students factor at confidence level of 95%
- $x_{1i}$  = Measured signal of system 1 (e.g. SN 1) at  $i^{\text{th}}$  concentration
- $x_{2i}$  = Measured signal of system 2 (e.g. SN 2) at  $i^{\text{th}}$  concentration

## 6.5 Assessment

The reproducibility for PM<sub>2.5</sub> was 11 for the complete dataset of the field test.

Minimum requirement fulfilled? yes

## 6.6 Detailed presentation of test results

The test results are summarised in Table 23. The graphical representation for PM<sub>2.5</sub> is shown in Figure 36 to Figure 40.

Note: The determined uncertainties are applied to reference value B<sub>1</sub> for each test site.

**Table 23:** Concentration averages, standard deviation, uncertainty range and reproducibility in the field, measured component PM<sub>2.5</sub>

Test site	No. of values	$\bar{c}$ (SN 1)	$\bar{c}$ (SN 2)	$\bar{c}_{ges}$	S <sub>D</sub>	t	U	R
		µg/m <sup>3</sup>	µg/m <sup>3</sup>	µg/m <sup>3</sup>	µg/m <sup>3</sup>		µg/m <sup>3</sup>	
Cologne (winter)	52	20.9	21.2	21.0	1.014	2.007	2.04	12
Bornheim (summer)	91	12.3	12.0	12.1	1.153	1.986	2.29	11
Bornheim (winter)	49	21.7	21.6	21.6	1.061	2.010	2.13	12
Teddington (summer)	59	7.5	7.6	7.5	0.611	2.001	1.22	20
All sites	251	14.8	14.8	14.8	1.167	1.969	2.30	11

- $\bar{c}$  (SN 1): Concentration averages, system SN 1
- $\bar{c}$  (SN 2): Concentration averages, system SN 2
- $\bar{c}_{ges}$ : Concentration averages of systems SN 1 & SN 2

The single values are presented in annex 5 of the appendix.

## 6.1 5.3.12 Long-term drift

*The long-term drift at zero point and reference point shall not exceed the requirements of Table 2 of Standard VDI 4202 Part 1 (September 2010) in the field test. A value  $c_i$  at 70 % to 80 % of the upper limit of the certification range shall be used as reference point.*

Note:

This item cannot be evaluated according to the current versions of Standards VDI 4202 Part 1 (September 2010) and VDI 4203 Part 3 (September 2010) when testing particulate measuring systems, due to the fact that a minimum requirement has not been defined. By resolution of the competent German body (see module 5.3.1), reference is made to the following requirement in the previous version of Standard VDI 4202 Part 1 (June 2002):

*The temporal change in the measured value at zero concentration shall not exceed the reference value  $B_0$  in 24 h and in the maintenance interval.*

*The temporal change in the measured value in the range of the reference value  $B_1$  shall not exceed 5 % of  $B_1$  in 24 h and in the maintenance interval.*

## 6.2 Equipment

Zero filter for testing the zero point and span foil set for testing the reference point.

## 6.3 Performance of test

The test was performed as part of the field test over a period 20 months.

As part of the monthly regular checks (including those at the beginning and at the end of tests at each field test site), the measuring systems were operated with a zero filter at the device inlet over a period of at least 24 h each. The values obtained at zero concentration were evaluated.

Furthermore, the stability of the mass coefficient was tested and evaluated as reference point check at the beginning and at the end of the tests at each field test site.

## 6.4 Evaluation

An evaluation of the drift at zero point and of the measured value in 24 h is not possible.

The zero point drift was evaluated on the basis of the results of the external zero point measurements performed on a regular basis. For this, the values were compared with the “measured values” of the previous test and with the “measured values” of the first test.

On 11 May 2011, a zero value of  $-1.0 \mu\text{g}/\text{m}^3$  was measured by SN 1. This value deviates by  $2.9 \mu\text{g}/\text{m}^3$  from the previous and next value as well as by  $2.6 \mu\text{g}/\text{m}^3$  from the start value. A cause for this strong fluctuation could not be determined. The measured value lies, however, within the permissible range of  $\pm 2 \mu\text{g}/\text{m}^3$ .

The AMS was not re-adjusted during the test.

The reference point drift was evaluated on the basis of the results of the mass coefficient determination. Here again, the values were compared with the “measured values” of the previous test and with the “measured values” of the first test.

The large deviation found for SN 1 during the span foil measurements carried out from 12 May 2011 to 19 July 2011 was caused by a damaged filter foil set. This was only detected on 14 November 2011, after another unusually large deviation was found. The test was then repeated with a new set of filter foils and the system passed showing no abnormalities. The deviations determined by comparison with the previous values (see yellow marking in Table 25) are therefore not attributable to the measuring system.

It should be noted that concentration values could not be simulated by checking the mass coefficient. It was therefore not possible to examine the range of  $B_1$ .

## 6.5 Assessment

The maximum deviation at zero point was  $-2.9 \mu\text{g}/\text{m}^3$  in relation to the previous value and  $-2.6 \mu\text{g}/\text{m}^3$  in relation to the start value. It should be noted that all absolute measured values lie within the permissible range of  $\pm 2 \mu\text{g}/\text{m}^3$ . All further deviations both from the previous value and from the start value are also within the permissible limits of  $B_0 = 2 \mu\text{g}/\text{m}^3$ .

The values obtained during the sensitivity drift tests amount to a maximum of  $-2.9 \%$  in relation to the previous value for PM<sub>2.5</sub>.

Minimum requirement fulfilled? yes

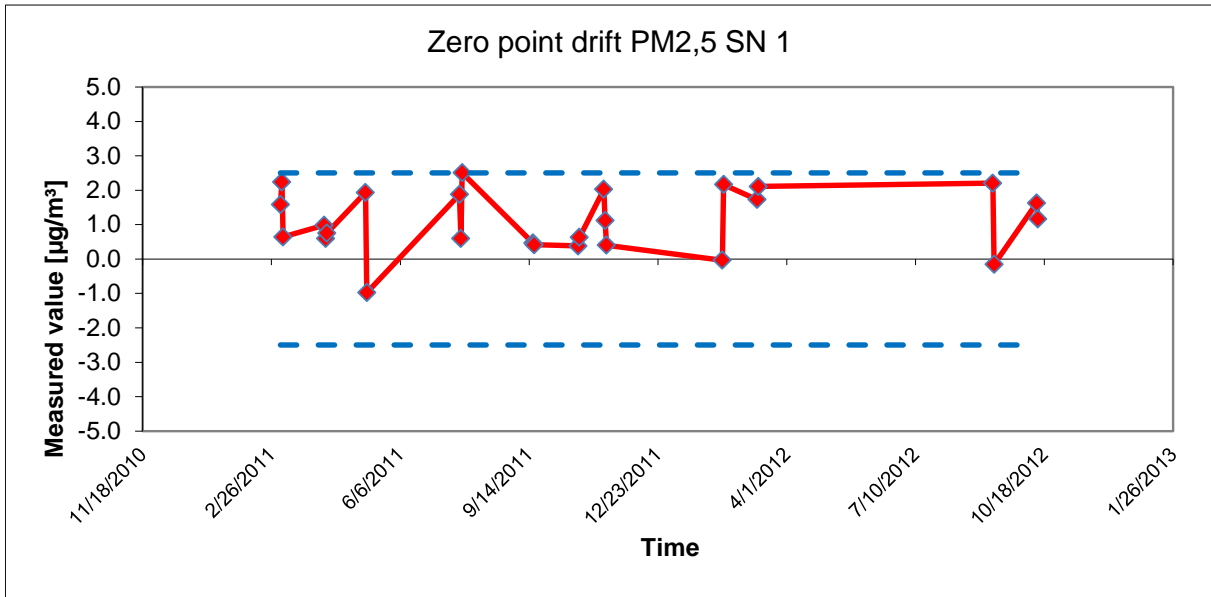
## 6.6 Detailed presentation of test results

Table 24 presents the values obtained at zero concentration and the calculated deviations in relation to the previous value and to the start value in  $\mu\text{g}/\text{m}^3$ . Figure 30 to Figure 31 presents a graph of the zero point drift during the entire test.

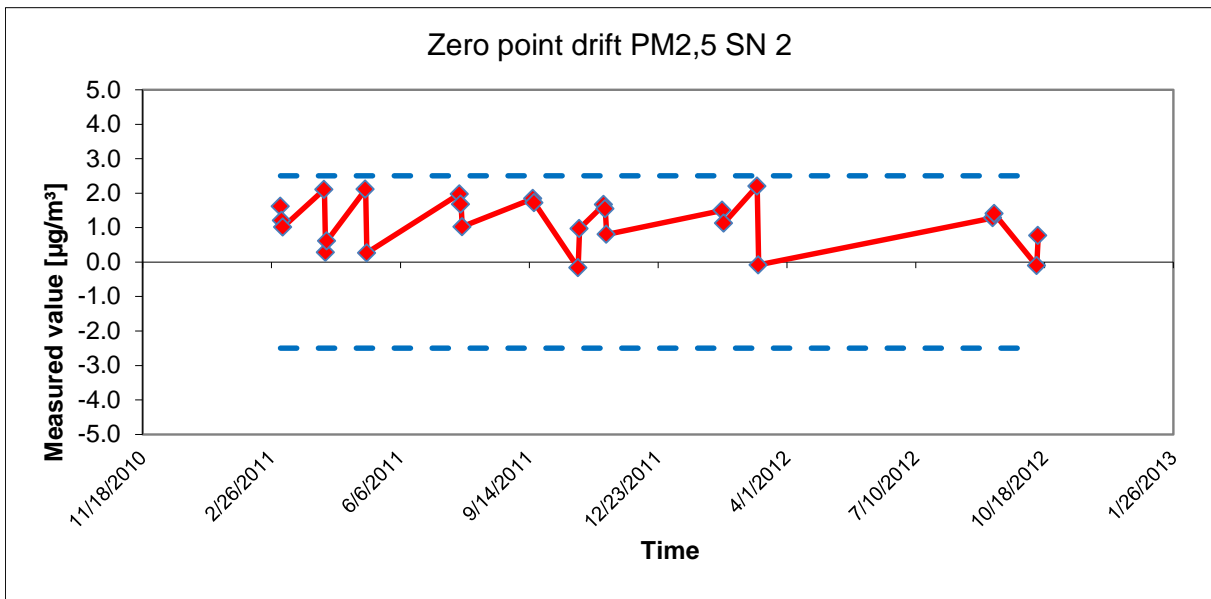
Table 25 shows the deviations of the measured values from the respective previous value in %. Figure 32 and Figure 33 presents a graph of the drift of the measured values (in relation to the previous value).

**Table 24:** Zero point drift SN 1 & SN 2, test with zero filter

Date	SN 1			Date	SN 2		
	Measured Value	Deviation from previous value	Deviation from start value		Measured Value	Deviation from previous value	Deviation from start value
	$\mu\text{g}/\text{m}^3$	$\mu\text{g}/\text{m}^3$	$\mu\text{g}/\text{m}^3$		$\mu\text{g}/\text{m}^3$	$\mu\text{g}/\text{m}^3$	$\mu\text{g}/\text{m}^3$
3/5/2011	1.6	-	-	3/5/2011	1.6	-	-
3/6/2011	2.2	0.7	0.7	3/6/2011	1.2	-0.4	-0.4
3/7/2011	0.6	-1.6	-0.9	3/7/2011	1.0	-0.2	-0.6
4/8/2011	1.0	0.3	-0.6	4/8/2011	2.1	1.1	0.5
4/9/2011	0.6	-0.4	-1.0	4/9/2011	0.3	-1.8	-1.3
4/10/2011	0.8	0.2	-0.8	4/10/2011	0.6	0.3	-1.0
5/10/2011	1.9	1.2	0.4	5/10/2011	2.1	1.5	0.5
5/11/2011	-1.0	-2.9	-2.6	5/11/2011	0.3	-1.8	-1.3
7/22/2011	1.9	2.9	0.3	7/22/2011	2.0	1.7	0.4
7/23/2011	0.6	-1.3	-1.0	7/23/2011	1.7	-0.3	0.1
7/24/2011	2.5	1.9	0.9	7/24/2011	1.0	-0.7	-0.6
9/17/2011	0.5	-2.0	-1.1	9/17/2011	1.8	0.8	0.3
9/18/2011	0.4	-0.1	-1.2	9/18/2011	1.7	-0.1	0.1
10/22/2011	0.4	0.0	-1.2	10/22/2011	-0.2	-1.9	-1.7
10/23/2011	0.6	0.3	-0.9	10/23/2011	1.0	1.1	-0.6
11/11/2011	2.0	1.4	0.4	11/11/2011	1.7	0.7	0.1
11/12/2011	1.1	-0.9	-0.5	11/12/2011	1.6	-0.1	0.0
11/13/2011	0.4	-0.7	-1.2	11/13/2011	0.8	-0.7	-0.8
2/11/2012	0.0	-0.4	-1.6	2/11/2012	1.5	0.7	-0.1
2/12/2012	2.2	2.2	0.6	2/12/2012	1.1	-0.4	-0.5
3/9/2012	1.7	-0.4	0.2	3/9/2012	2.2	1.1	0.6
3/10/2012	2.1	0.4	0.5	3/10/2012	-0.1	-2.3	-1.7
9/8/2012	2.2	0.1	0.6	9/8/2012	1.3	1.4	-0.3
9/9/2012	-0.2	-2.4	-1.7	9/9/2012	1.4	0.1	-0.2
10/12/2012	1.6	1.8	0.0	10/12/2012	-0.1	-1.5	-1.7
10/13/2012	1.2	-0.5	-0.4	10/13/2012	0.8	0.9	-0.8



**Figure 30:** Zero point drift SN 1, measured component PM<sub>2.5</sub>



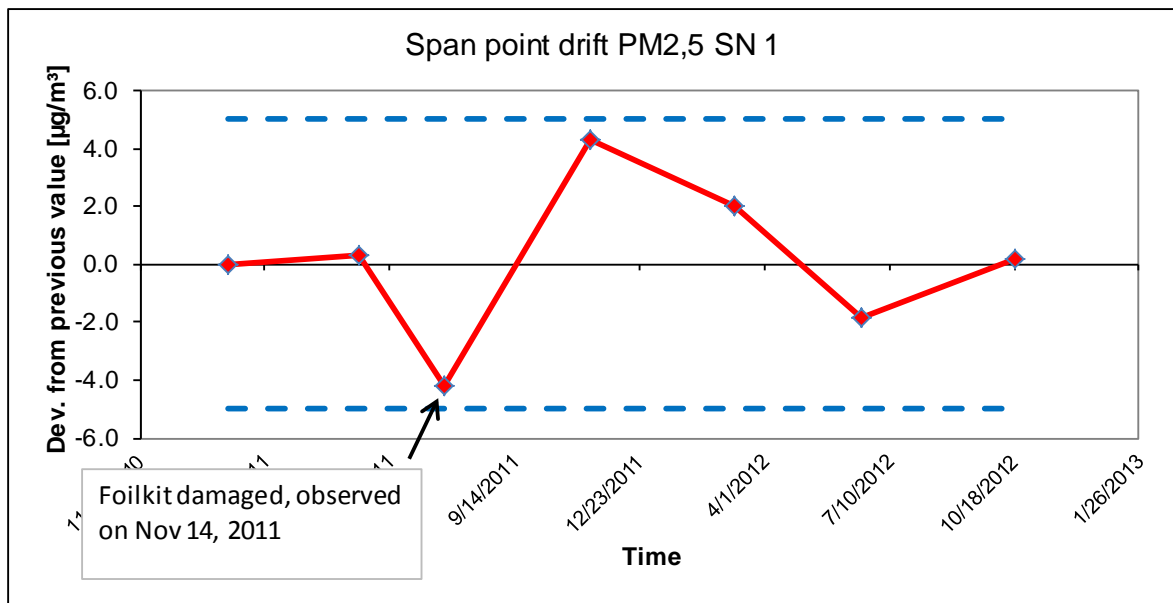
**Figure 31:** Zero point drift SN 2, measured component PM<sub>2.5</sub>



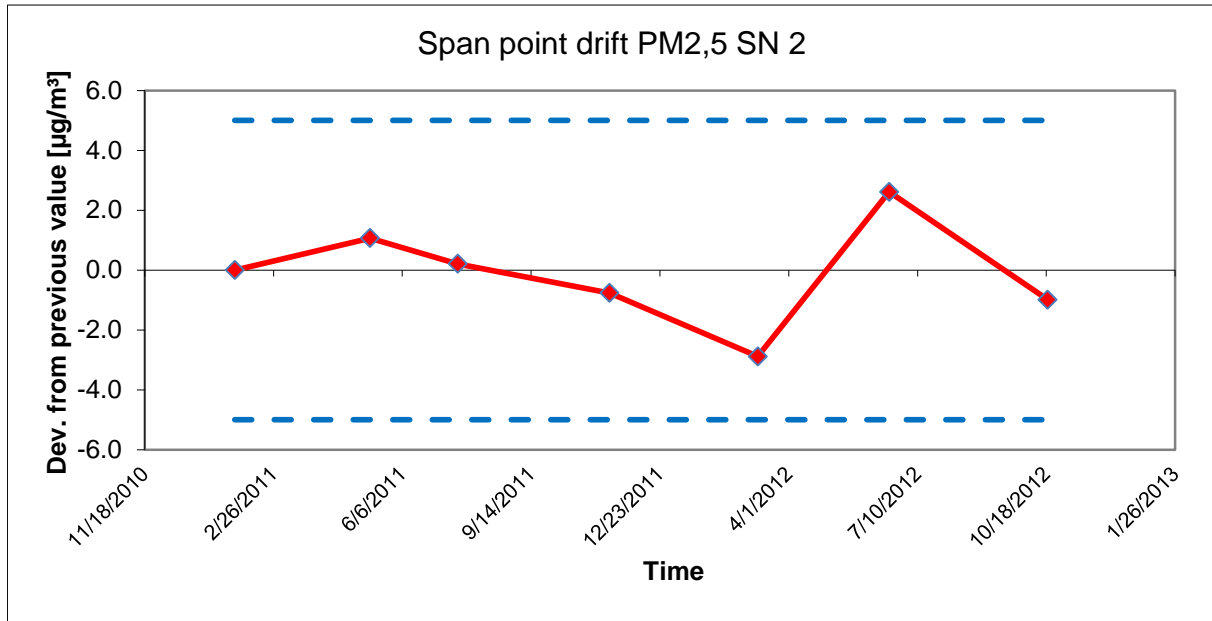
Report on the suitability test of the ambient air quality measuring system  
Model 5014i Beta with PM<sub>2.5</sub> pre-separator of the company Thermo Fisher  
Scientific for the component suspended particulate matter PM<sub>2.5</sub>,  
Report No.: 936/21209885/H

**Table 25:** Sensitivity drift SN 1 & SN 2

Date	SN 1			Date	SN 2		
	Measured Value	Deviation from previous value	Deviation from start value		Measured Value	Deviation from previous value	Deviation from start value
		%	%			%	%
1/27/2011	7170.9	-	-	1/27/2011	7178.5	-	-
5/12/2011	7194.2	0.3	0.3	5/12/2011	7255.4	1.1	1.1
7/19/2011	6890.2	-4.2	-3.9	7/19/2011	7270.6	0.2	1.3
11/14/2011	7189.0	4.3	0.3	11/14/2011	7215.0	-0.8	0.5
3/8/2012	7332.3	2.0	2.3	3/8/2012	7006.9	-2.9	-2.4
6/18/2012	7199.5	-1.8	0.4	6/18/2012	7190.2	2.6	0.2
10/19/2012	7214.0	0.2	0.6	10/19/2012	7119.2	-1.0	-0.8



**Figure 32:** Drift of the measured value SN 1, measured component PM<sub>2.5</sub>



**Figure 33:** Drift of the measured value SN 2, measured component PM<sub>2.5</sub>

## 6.1 5.3.13 Short-term drift

*The short-term drift at zero point and reference point shall not exceed the requirements of Table 2 of Standard VDI 4202 Part 1 (September 2010) within 12 h (for benzene 24 h) in the laboratory test and within 24 h in the field test. A value  $c_t$  at 70 % to 80 % of the upper limit of the certification range shall be used as reference point.*

Note:

By resolution of the competent German body (see module 5.3.1), this test is not relevant for particulate measuring systems.

## 6.2 Equipment

Not applicable.

## 6.3 Performance of test

Not applicable.

## 6.4 Evaluation

Not applicable.

## 6.5 Assessment

Not applicable.

Minimum requirement fulfilled? -

## 6.6 Detailed presentation of test results

Not applicable.

## **6.1 5.3.14 Response time**

*The response time (rise) of the measuring system shall not exceed 180 s.*

*The response time (fall) of the measuring system shall not exceed 180 s.*

*The difference between the response time (rise) and response time (fall) of the measuring system shall not exceed 10 % of response time (rise) or 10 s, whatever value is larger.*

Note:

This test is not relevant for particulate measuring systems.

## **6.2 Equipment**

Not applicable.

## **6.3 Performance of test**

Not applicable.

## **6.4 Evaluation**

Not applicable.

## **6.5 Assessment**

Not applicable.

Minimum requirement fulfilled? -

## **6.6 Detailed presentation of test results**

Not applicable.

## **6.1 5.3.15 Difference between sample and calibration port**

*The difference between the measured values obtained by feeding gas at the sample and calibration port shall not exceed the requirements of Table 2 of Standard VDI 4202 Part 1 (September 2010). A value  $c_t$  at 70 % to 80 % of the upper limit of the certification range shall be used as reference point.*

Note:

This test is not relevant for particulate measuring systems.

## **6.2 Equipment**

Not applicable.

## **6.3 Performance of test**

Not applicable.

## **6.4 Evaluation**

Not applicable.

## **6.5 Assessment**

Not applicable.

Minimum requirement fulfilled? -

## **6.6 Detailed presentation of test results**

Not applicable.

**6.1 5.3.16 Converter efficiency**

*In the case of measuring systems with a converter, the converter efficiency shall be at least 98 %.*

Note:

This test is not relevant for particulate measuring systems.

**6.2 Equipment**

Not applicable.

**6.3 Performance of test**

Not applicable.

**6.4 Evaluation**

Not applicable.

**6.5 Assessment**

Not applicable.

Minimum requirement fulfilled? -

**6.6 Detailed presentation of test results**

Not applicable.

## **6.1 5.3.17 Increase of NO<sub>2</sub> concentration due to residence in the measuring system**

*In case of NO<sub>x</sub> measuring systems the increase of NO<sub>2</sub> concentration due to residence in the measuring system shall not exceed the requirements of Table 2 of Standard VDI 4202 Part 1 (September 2010).*

*The requirements of Table 2 apply to certification ranges according to Table 1 of Standard VDI 4202 Part 1 (September 2010). For deviating certification ranges the requirements shall be proportionally converted.*

Note:

This test is not relevant for particulate measuring systems.

## **6.2 Equipment**

Not applicable.

## **6.3 Performance of test**

Not applicable.

## **6.4 Evaluation**

Not applicable.

## **6.5 Assessment**

Not applicable.

Minimum requirement fulfilled? -

## **6.6 Detailed presentation of test results**

Not applicable.

## **6.1 5.3.18 Overall uncertainty**

*The expanded uncertainty of the measuring system shall be determined. The value determined shall not exceed the corresponding data quality objectives in the applicable EU Directives on air quality listed in Annex A, Table A1 of Standard VDI 4202 Part 1 (September 2010).*

Note:

By resolution of the competent German body (see module 5.3.1), this test is not relevant for particulate measuring systems. Reference is made to module 5.4.10.

## **6.2 Equipment**

By resolution of the competent German body (see module 5.3.1), this test is not relevant for particulate measuring systems. Reference is made to module 5.4.10.

## **6.3 Performance of test**

By resolution of the competent German body (see module 5.3.1), this test is not relevant for particulate measuring systems. Reference is made to module 5.4.10.

## **6.4 Evaluation**

By resolution of the competent German body (see module 5.3.1), this test is not relevant for particulate measuring systems. Reference is made to module 5.4.10.

## **6.5 Assessment**

By resolution of the competent German body (see module 5.3.1), this test is not relevant for particulate measuring systems. Reference is made to module 5.4.10.

Minimum requirement fulfilled? -

## **6.6 Detailed presentation of test results**

By resolution of the competent German body (see module 5.3.1), this test is not relevant for particulate measuring systems. Reference is made to module 5.4.10.



## 6.1 5.4.1 General

*Testing of measuring systems for particulate air pollutants is carried out in compliance with the minimum requirement stated in Table 5 of Standard VDI 4202, Part 1.*

*Furthermore, the particle mass concentration shall be related to a defined volume. The relation to volume with respect to pressure and temperature shall be comprehensively described.*

## 6.2 Equipment

No additional equipment required.

## 6.3 Performance of test

Testing was carried out in compliance with the minimum requirements stated in Table 5 of Standard VDI 4202, Part 1 (September 2010).

It was tested, whether the measured particulate mass concentrations are related to a defined volume.

## 6.4 Evaluation

Testing was carried out in compliance with the minimum requirements stated in Table 5 of Standard VDI 4202, Part 1 (September 2010).

The Model 5014i Beta measuring system is a radiometric AMS. The mass collected on the filter tape is determined by the radiometric measurement. The calculated mass is then related to a defined and actively regulated sampling volume, thus determining the particulate mass concentration.

## 6.5 Assessment

Testing was carried out in compliance with the minimum requirements stated in Table 5 of Standard VDI 4202, Part 1 (September 2010).

The calculated mass is related to a defined and actively regulated sampling volume, thus determining the particulate mass concentration.

Minimum requirement fulfilled? yes

## 6.6 Detailed presentation of test results

Not required for this test.

## **6.1 5.4.2 Equivalency of the sampling system**

*The equivalency between the PM<sub>10</sub> sampling system and the reference method according to EN 12341 [T5] shall be demonstrated.*

Note:

Not applicable to PM<sub>2.5</sub> sampling systems. Reference is made to module 5.4.10 of this report.

## **6.2 Equipment**

Not applicable to PM<sub>2.5</sub> sampling systems. Reference is made to module 5.4.10 of this report.

## **6.3 Performance of test**

Not applicable to PM<sub>2.5</sub> sampling systems. Reference is made to module 5.4.10 of this report.

## **6.4 Evaluation**

Not applicable to PM<sub>2.5</sub> sampling systems. Reference is made to module 5.4.10 of this report.

## **6.5 Assessment**

Not applicable to PM<sub>2.5</sub> sampling systems. Reference is made to module 5.4.10 of this report.  
Minimum requirement fulfilled? --

## **6.6 Detailed presentation of test results**

Not applicable to PM<sub>2.5</sub> sampling systems. Reference is made to module 5.4.10 of this report.

## 6.1 5.4.3 Reproducibility of the sampling systems

*The PM<sub>10</sub> sampling systems of two identical systems under test shall be reproducible among themselves according to EN 12341 [T5]. This shall be demonstrated in the field test.*

Note:

Not applicable to PM<sub>2.5</sub> sampling systems. Reference is made to module 5.4.9 of this report.

## 6.2 Equipment

Not applicable to PM<sub>2.5</sub> sampling systems. Reference is made to module 5.4.9 of this report.

## 6.3 Performance of test

Not applicable to PM<sub>2.5</sub> sampling systems. Reference is made to module 5.4.9 of this report.

## 6.4 Evaluation

Not applicable to PM<sub>2.5</sub> sampling systems. Reference is made to module 5.4.9 of this report.

## 6.5 Assessment

Not applicable to PM<sub>2.5</sub> sampling systems. Reference is made to module 5.4.9 of this report.  
Minimum requirement fulfilled? -

## 6.6 Detailed presentation of test results

Not applicable to PM<sub>2.5</sub> sampling systems. Reference is made to module 5.4.9 of this report.

## 6.1 5.4.4 Calibration

*The systems under test shall be calibrated in the field test by comparison measurements with the reference method. Here, the relationship between the output signal and the gravimetrically determined reference concentration shall be determined as a steady function.*

## 6.2 Equipment

See module 5.4.10.

## 6.3 Performance of test

For PM<sub>2.5</sub>:

The comparability of the measuring systems according to module 5.4.10 was demonstrated during the test.

The determination of the calibration and analysis function was carried out using the complete dataset (215 (SN 1) and 219 (SN 2) valid paired values).

The parameters of the calibration function

$$y = m * x + b$$

were determined by orthogonal regression. The analysis function is the reversal of the calibration function. It reads:

$$x = 1/m * y - b/m$$

The slope  $m$  of the regression line characterises the sensitivity of the measuring system; the ordinate intercept  $b$  characterises the zero point.

## 6.4 Evaluation

This results in the following parameters:

**Table 26:** Parameters of the calibration and analysis function, measured component PM<sub>2.5</sub>

System No.	Calibration function		Analysis function	
	Y = m * x + b		x = 1/m * y - b/m	
	m	b	1/m	b/m
	µg/m <sup>3</sup> / µg/m <sup>3</sup>	µg/m <sup>3</sup>	µg/m <sup>3</sup> / µg/m <sup>3</sup>	µg/m <sup>3</sup>
System 1 (SN 1)	1.089	-0.062	0.918	-0.057
System 2 (SN 2)	1.056	0.430	0.950	0.407

Report on the suitability test of the ambient air quality measuring system  
Model 5014i Beta with PM<sub>2.5</sub> pre-separator of the company Thermo Fisher  
Scientific for the component suspended particulate matter PM<sub>2.5</sub>,  
Report No.: 936/21209885/H

Page 129 of 417

## **6.5 Assessment**

A statistical correlation between the reference measuring method and the device reading could be demonstrated.

Minimum requirement fulfilled? yes

## **6.6 Detailed presentation of test results**

See module 5.4.10.

## **6.1 5.4.5 Cross-sensitivity**

*The interference caused by moisture in the sample may not exceed 10 % of the limit value in the range of the limit value.*

## **6.2 Equipment**

No additional equipment required.

## **6.3 Performance of test**

The determination of interference caused by moisture in the sample was carried out under field conditions.

For this purpose, the differences between the determined reference value (= nominal value) and the measured value of the respective candidate were calculated for days with more than 70 % relative humidity during the field test. The average difference was set as conservative estimate of the interference caused by moisture in the sample.

In addition, the reference equivalence functions of both candidates were determined from the field investigations for days with more than 70 % relative humidity.

## **6.4 Evaluation**

The average difference between the determined reference value (= nominal value) and the measured value of the respective candidate was calculated for days with more than 70 % relative humidity during the field test. The relative deviation from the average concentration was calculated.

Annual limit value PM<sub>2.5</sub> = 25 µg/m<sup>3</sup>

10 % of ALV = 2.5 µg/m<sup>3</sup>

Further investigations were made to determine whether the comparability of both candidates with the reference method according to Guide „Demonstration of Equivalence of Ambient Air Monitoring Methods” [4] is also given for days with more than 70 % relative humidity.

## 6.5 Assessment

No deviation of the measured signal from the nominal value  $> 0.9 \mu\text{g}/\text{m}^3$  caused by interference of moisture in the sample could be observed for PM<sub>2.5</sub>. No negative influence on the measured values at varying relative humidity was detected during the field test. Comparability of the candidates with the reference method according to Guide „Demonstration of Equivalence of Ambient Air Monitoring Methods” [4] is also given for days with a relative humidity  $> 70 \%$ .

Minimum requirement fulfilled? yes

## 6.6 Detailed presentation of test results

A summary of the results is presented in Table 27.

**Table 27:** Deviation between reference measurement and candidate on days with a relative humidity  $> 70 \%$ , measured component PM<sub>2.5</sub>

Field test, days with a relative humidity $> 70 \%$				
		Reference	SN 1	SN 2
Average	$\mu\text{g}/\text{m}^3$	12.1	13.0	12.8
Deviation from reference mean value in $\mu\text{g}/\text{m}^3$	$\mu\text{g}/\text{m}^3$	-	0.9	0.8
Deviation from reference mean value in %	%	-	7.9	6.2
Deviation from ALV in %	%	-	3.8	3.0

The single values are presented in annexes 5 and 6 of the appendix.

The presentation and the assessment of the measuring uncertainties  $W_{\text{CM}}$  of days with a relative humidity  $> 70 \%$  are shown in Table 28 and Table 29. The single values are presented in annexes 5 and 6 of the appendix.

**Table 28:** Comparison candidate SN 1 with reference instrument, rel. humidity > 70 %, all test sites, measured component PM<sub>2.5</sub>

Comparison candidate with reference according to Guide "Demonstration of Equivalence Of Ambient Air Monitoring Methods", January 2010				
Candidate	Model 5014i BETA	SN	SN 1	
Test site	All test sites, rH>70%	Limit value	30	µg/m <sup>3</sup>
Status of measured values	Raw data	Allowed uncertainty	25	%
Results of regression analysis				
Slope b	<b>1.08</b>	<b>significant</b>		
Uncertainty of b	<b>0.02</b>			
Ordinate intercept a	<b>0.06</b>	<b>not significant</b>		
Uncertainty of a	<b>0.28</b>			
Results of the equivalence test				
Deviation at limit value	<b>2.34</b>	<b>µg/m<sup>3</sup></b>		
Uncertainty $u_{c,s}$ at limit value	<b>3.11</b>	<b>µg/m<sup>3</sup></b>		
Combined measurement uncertainty $w_{CM}$	<b>10.36</b>	<b>%</b>		
Expanded measurement uncertainty $W_{CM}$	<b>20.73</b>	<b>%</b>		
Status equivalence test	<b>pass</b>			

**Table 29:** Comparison candidate SN 2 with reference instrument, rel. humidity > 70 %, all test sites, measured component PM<sub>2.5</sub>

Comparison candidate with reference according to Guide "Demonstration of Equivalence Of Ambient Air Monitoring Methods", January 2010				
Candidate	Model 5014i BETA	SN	SN 2	
Test site	All test sites, rH>70%	Limit value	30	µg/m <sup>3</sup>
Status of measured values	Raw data	Allowed uncertainty	25	%
Results of regression analysis				
Slope b	<b>1.07</b>	<b>significant</b>		
Uncertainty of b	<b>0.02</b>			
Ordinate intercept a	<b>0.13</b>	<b>not significant</b>		
Uncertainty of a	<b>0.29</b>			
Results of the equivalence test				
Deviation at limit value	<b>2.11</b>	<b>µg/m<sup>3</sup></b>		
Uncertainty $u_{c,s}$ at limit value	<b>2.97</b>	<b>µg/m<sup>3</sup></b>		
Combined measurement uncertainty $w_{CM}$	<b>9.91</b>	<b>%</b>		
Expanded measurement uncertainty $W_{CM}$	<b>19.81</b>	<b>%</b>		
Status equivalence test	<b>pass</b>			



## 6.1 5.4.6 Averaging effect

*The measuring system shall allow for formation of 24 h averages.*

*The time of the sum of all filter changes within 24 h may not exceed 1 % of this averaging time.*

## 6.2 Equipment

A clock was required for this test.

## 6.3 Performance of test

It was tested, whether the AMS allows the formation of daily averages.

## 6.4 Evaluation

By default, the measuring system saves the measured values as 5-minute averages or hourly averages (configuration used during suitability testing) in the internal storage. These values can, for example, be read out on the iPort software and processed as required with a spread sheet analysis. Furthermore, it is also possible to parameterise the AMS in a way that daily averages are calculated internally and output as such.

The filter tape transport itself takes approx. 1 min. After changing the filter tape, the radiometric measurement is zeroed. The radiometric measurement zeroes within 15 minutes after pump stop.

The time required for filter tape transport is 1 min. It corresponds to approx. 0.21 % lag time for 24-h measurements with three tape changes a day.

The available time of the Beta signal at cycles of 8 h is 465 min (=480 min – 15 min), covering 96.9 % of the total time.

## 6.5 Assessment

It is possible to form daily averages based on the three measurement cycles using the described instrument configuration and a cycle duration of 8 hours.

The time required for changing the filter tape amounts to a maximum of 0.21 %, thus lying well below the permissible 1 %.

Minimum requirement fulfilled? yes

## 6.6 Detailed presentation of test results

Not required for this test.

## **6.1 5.4.7 Constancy of sample volumetric flow**

*The sample volumetric flow averaged over the sampling time shall be constant within  $\pm 3$  % of the rated value. All instantaneous values of the sample volumetric flow shall be within a range of  $\pm 5$  % of the rated value during sampling.*

## **6.2 Equipment**

A flow meter was used for testing this requirement, as indicated in Section 4.

## **6.3 Performance of test**

The sample volumetric flow was calibrated before testing at the first field test site, checked with a dry gas meter or a mass flow meter before testing at the other field test sites, and if necessary readjusted.

The constancy of the sample volumetric flow is monitored internally with a reliable deviation from the nominal value of  $\pm 2.5$  %. If this criterion is not met during operation, the measuring system performs a filter change.

To determine the constancy of the sample volumetric flow, the internal data regarding flow rate and pump vacuum (= information on filter load) were recorded for the test site Cologne (winter), characterised partly by high concentrations, and the flow rates were evaluated on a 24-h basis.

## **6.4 Evaluation**

Average values, standard deviations as well as maximum and minimum values were determined from the flow rate measured values.

## 6.5 Assessment

The results of the flow rate checks performed before testing at each field test site are presented in Table 30.

**Table 30:** Results of flow rate checks

Flow rate check before testing at:	SN 1		SN 2	
	[l/min]	Deviation from nominal value [%]	[l/min]	Deviation from nominal value [%]
Test site:				
Cologne, winter	16.33	-2.04	16.44	-1.38
Bornheim, summer	16.48	-1.14	16.51	-0.96
Bornheim, winter	16.66	-0.06	16.68	0.06
Teddington, summer	16.80	0.78	16.62	-0.30

The graphical representation of the flow rates at the test site used as example (Cologne, winter, nominal: 16.67 l/min) shows that all values determined during sampling deviate less than  $\pm 5$  % from the respective nominal value. The deviation of the 24-h averages for the total flow rate of 16.67 l/min is as well significantly smaller than the specified  $\pm 3$  % of the nominal value.

All determined daily averages present deviations less than  $\pm 3$  % from the nominal value; all instantaneous values deviate less than  $\pm 5$  %.

Minimum requirement fulfilled? yes

## 6.6 Detailed presentation of test results

Table 31 and Table 32 show the determined flow parameters. Figure 34 and Figure 35 illustrate the flow measurements for both candidates SN 1 and SN 2.

**Table 31:** Parameters for flow measurement (24-h average), SN 1 (field)

No. 24h-values	Mean [l/min]	Dev. from nominal [%]	Std.Dev. [l/min]	Max [l/min]	Min [l/min]
102	16.67	0.00	0.02	17.20	16.56

**Table 32:** Parameters for flow measurement (24-h average), SN 2 (field)

No. 24h-values	Mean [l/min]	Dev. from nominal [%]	Std.Dev. [l/min]	Max [l/min]	Min [l/min]
103	16.67	0.00	0.02	16.74	16.60

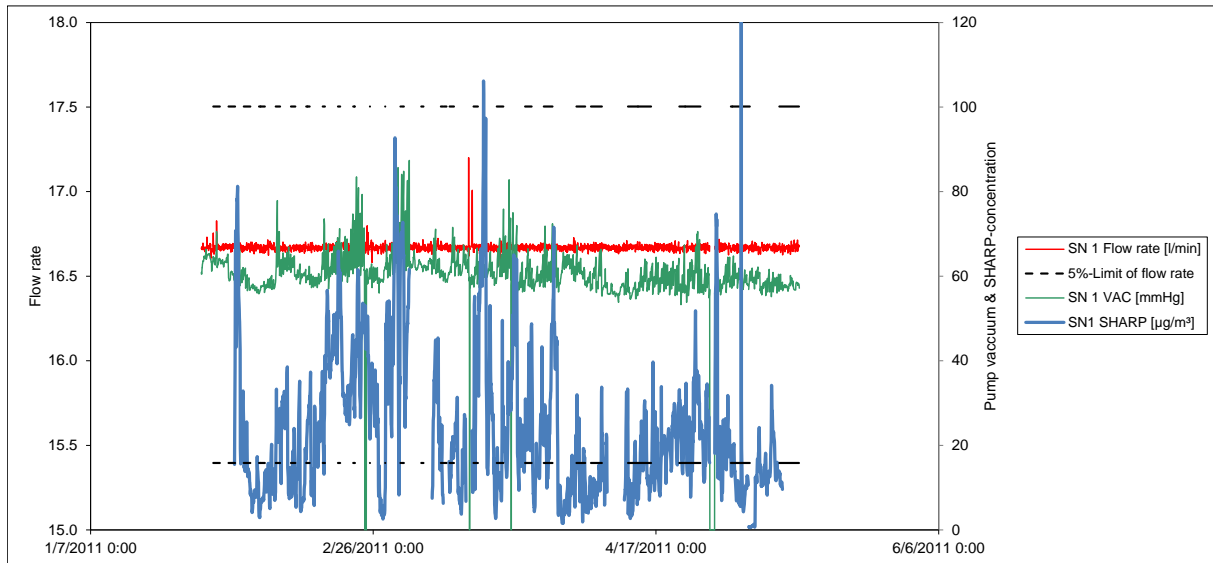


Figure 34: Flow of candidate SN 1 (field)

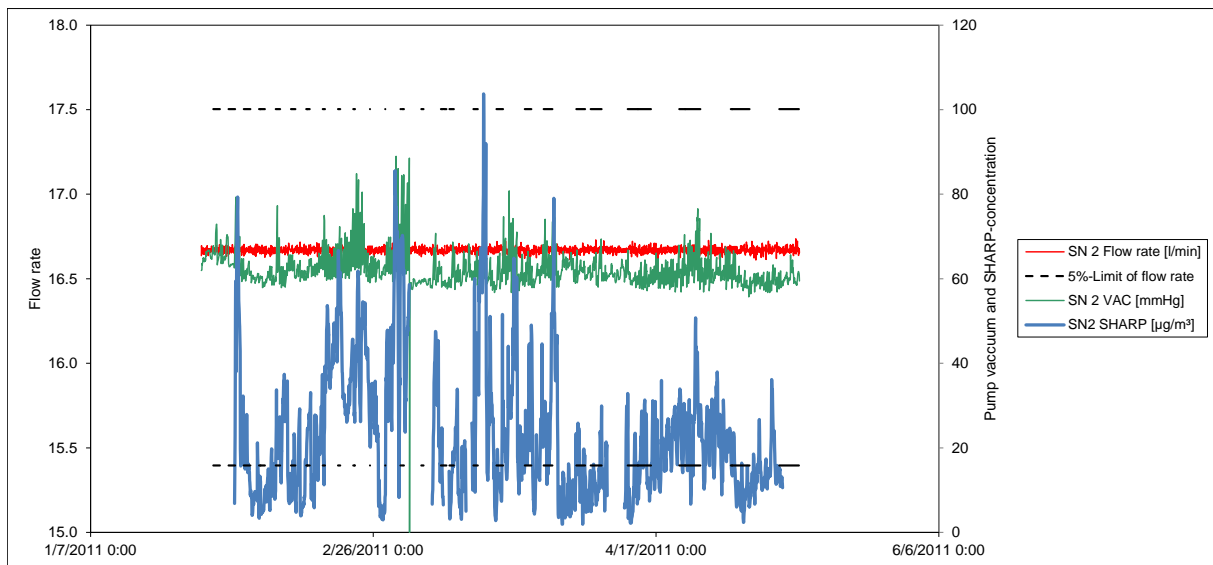


Figure 35: Flow of candidate SN 2 (field)

## **6.1 5.4.8 Tightness of the measuring system**

*The complete measuring system shall be checked for tightness. Leakage shall not exceed 1 % of the sample volume sucked.*

## **6.2 Equipment**

The test required an adapter for tightness check and a mass flow meter.

## **6.3 Performance of test**

The Model 5014i Beta can perform a tightness check using an adapter.

For testing the leak tightness, the instrument is switched to service mode. First, an external flow meter is installed at the inlet, followed by a recording of the flow rates indicated on the instrument itself and by the external measurement as well as of the displayed vacuum (VAC in mmHg). The instrument flow rate is compared with the flow rate of the external flow meter and adjusted. Then, the tightness check adapter is inserted into the inlet as connection between inlet and external flow meter. The adapter creates a significantly higher vacuum in the instrument for it reduces the size of the air sampling opening. The flow rates indicated by the instrument and by the external flow meter are compared again. Ideally (i.e. at absolute tightness), there should be no difference between both flow rates. The manufacturer specifies a maximum permissible difference of 0.42 l/min (= 2.5 % of the flow rate). If greater deviations were to be found, a leak test must be performed taking special care of checking the many fittings above the radiometric measuring head. If the cause cannot be found, the manufacturer should be contacted.

The tightness check must only be performed with the tightness check adapter and the described procedure. It can otherwise damage the instrument.

It is recommended to check the tightness of the measuring system on a quarterly basis according to the described procedure

## **6.4 Evaluation**

The tightness was checked with the adapter as part of the laboratory test.

The criteria specified by the manufacturer upon which the tightness check is considered passed – maximum difference of 0.42 l/min (= 2.5 % of the flow rate) between the flow rates measured by the instrument and by the external flow meter under application of the adapter – proved to be appropriate parameters for monitoring the instrument's tightness. The laboratory tests resulted in a maximum leakage < 1 % of the nominal flow rate of 16.67 l/min for both candidates.

The tightness check must only be performed with the tightness check adapter and the described procedure. It can otherwise damage the instrument.

## 6.5 Assessment

The criteria specified by the manufacturer upon which the tightness check is considered passed – maximum difference of  $\pm 0.42$  l/min (=  $\pm 2.5$  % of the flow rate) between the flow rates measured by the instrument and by the external flow meter under application of the adapter – proved to be appropriate parameters for monitoring the instrument's tightness. The laboratory tests resulted in a maximum leakage < 1 % of the nominal flow rate of 16.67 l/min for both candidates.

The tightness check must only be performed with the tightness check adapter and the described procedure. It can otherwise damage the instrument.

Minimum requirement fulfilled? yes

## 6.6 Detailed presentation of test results

Table 33 contains the values determined during the tightness check.

**Table 33:** Results of the tightness check

		System's measured value, without adapter	Pump vacuum, without adapter	System's measured value, with adapter	Pump vacuum, with adapter	Ext. flow meter's measured value, with adapter	Difference of flow rates, with adapter	Related to nominal flow rate
		l/min	mm Hg	l/min	mm Hg	l/min	l/min	%
SN 1	1	16.65	66	16.58	106	16.59	0.01	0.1
	2	16.67	66	16.59	106	16.66	0.07	0.4
	3	16.63	66	16.58	106	16.64	0.06	0.4
	Avg.	16.65	66	16.58	106	16.63	0.05	0.3
SN 2	1	16.70	140	16.56	197	16.57	0.01	0.1
	2	16.60	140	16.40	197	16.48	0.08	0.5
	3	16.58	140	16.45	197	16.51	0.06	0.4
	Avg.	16.63	140	16.47	197	16.52	0.05	0.3

## 6.1 Methodology of the equivalence check (modules 5.4.9 – 5.4.11)

According to the version of the Guide from January 2010 [4] the following 5 criteria must be fulfilled to proof the equivalence.

1. Of the full dataset at least 20 % of the results obtained using the standard method shall be greater than the upper assessment threshold specified in 2008/50/EC for annual limit values *i.e.*: 28 µg/m<sup>3</sup> for PM<sub>10</sub> and currently 17 µg/m<sup>3</sup> for PM<sub>2.5</sub>.
2. The in-between uncertainty of the candidate must be less than 2.5 µg/m<sup>3</sup> for all data and for two sub datasets corresponding to all the data split greater than or equal to and lower than 30 µg/m<sup>3</sup> or 18 µg/m<sup>3</sup> for PM<sub>10</sub> and PM<sub>2.5</sub> respectively.
3. The in-between uncertainty of the reference method must be less than 2.0 µg/m<sup>3</sup>.
4. The expanded uncertainty ( $W_{CM}$ ) is calculated at 50 µg/m<sup>3</sup> for PM<sub>10</sub> and 30 µg/m<sup>3</sup> for PM<sub>2.5</sub> for each individual candidate instrument against the average results of the reference method. For each of the following permutations, the expanded uncertainty must be less than 25 %:
  - Full dataset;
  - Datasets representing PM concentrations greater than or equal to 30 µg/m<sup>3</sup> for PM<sub>10</sub>, or concentrations greater than or equal to 18 µg/m<sup>3</sup> for PM<sub>2.5</sub>, provided that the subset contains 40 or more valid data pairs;
  - Datasets for each individual test site.
5. Preconditions for acceptance of the full dataset are that: the slope  $b$  is insignificantly different from 1:  $|b - 1| \leq 2 \cdot u(b)$ , and the intercept  $a$  is insignificantly different from 0:  $|a| \leq 2 \cdot u(a)$ . If these preconditions are not met, the candidate method may be calibrated using the values obtained for slope and/or intercept of all paired instruments together.

The fulfilment of the 5 criteria is checked in the following chapters:

In chapter 6.1 5.4.9 Determination of uncertainty between systems under test  $u_{bs}$  criteria 1 and 2 will be checked.

In chapter 6.1 5.4.10 Calculation of the expanded uncertainty of the instruments criteria 3, 4 and 5 will be checked.

In chapter 6.1 5.4.11 Application of correction factors and terms, there is an exemplary evaluation for the case, that criterion 5 cannot be fulfilled without the application of correction factors or terms.



## 6.1 5.4.9 Determination of uncertainty between systems under test $u_{bs}$

*For the test of PM<sub>2.5</sub> measuring systems the uncertainty between the systems under test shall be determined according to chapter 9.5.3.1 of the guidance document „Demonstration of Equivalence of Ambient Air Monitoring Methods“ in the field test at least at four sampling sites representative of the future application.*

## 6.2 Equipment

No additional equipment required.

## 6.3 Performance of test

The test was carried out at four different comparisons during field test. Different seasons and varying concentrations for PM<sub>2.5</sub> were taken into consideration.

Of the complete dataset, at least 20 % of the concentration values determined with the reference method shall be greater than the upper assessment threshold according to 2008/50/EC [7]. For PM<sub>2.5</sub> the upper assessment threshold is at 17 µg/m<sup>3</sup>.

At each comparison campaign at least 40 valid data pairs were determined. Of the complete dataset (4 test sites, 215 valid data pairs for SN 1, 219 valid data pairs for SN 2) a total of 28 % of the measured values are above the upper assessment threshold of 17 µg/m<sup>3</sup> for PM<sub>2.5</sub>. The measured concentrations were referred to ambient conditions.

## 6.4 Evaluation

According to **point 9.5.3.1** of the Guide „Demonstration of Equivalence of Ambient Air Monitoring Methods“ applies:

The uncertainty between the candidates  $u_{bs}$  must be  $\leq 2.5$  µg/m<sup>3</sup>. An uncertainty  $> 2.5$  µg/m<sup>3</sup> between the two candidates is an indication that the performance of one or both systems is not sufficient and the equivalence cannot be declared.

The uncertainty is determined for:

- All test sites and comparisons together (full dataset)
- 1 dataset with measured values  $\geq 18$  µg/m<sup>3</sup> for PM<sub>2.5</sub> (Basis: averages of reference measurement)

Furthermore the evaluation of the following datasets is done for:

- Each test site and comparison individually
- 1 dataset with measured values < 18 µg/m<sup>3</sup> for PM<sub>2.5</sub> (Basis: averages of reference measurement)

The uncertainty between the candidates  $u_{bs}$  is calculated from the differences of all 24-hour results of the simultaneously operated candidate systems according to the following equation:

$$u_{bs}^2 = \frac{\sum_{i=1}^n (y_{i,1} - y_{i,2})^2}{2n}$$

with  $y_{i,1}$  and  $y_{i,2}$  = results of the parallel measurements of individual 24-h values  $i$   
 $n$  = No. of 24-h values

## 6.5 Assessment

The uncertainty between the candidates  $u_{bs}$  is with a maximum of 1.69 µg/m<sup>3</sup> for PM<sub>2.5</sub> below the required value of 2.5 µg/m<sup>3</sup>.

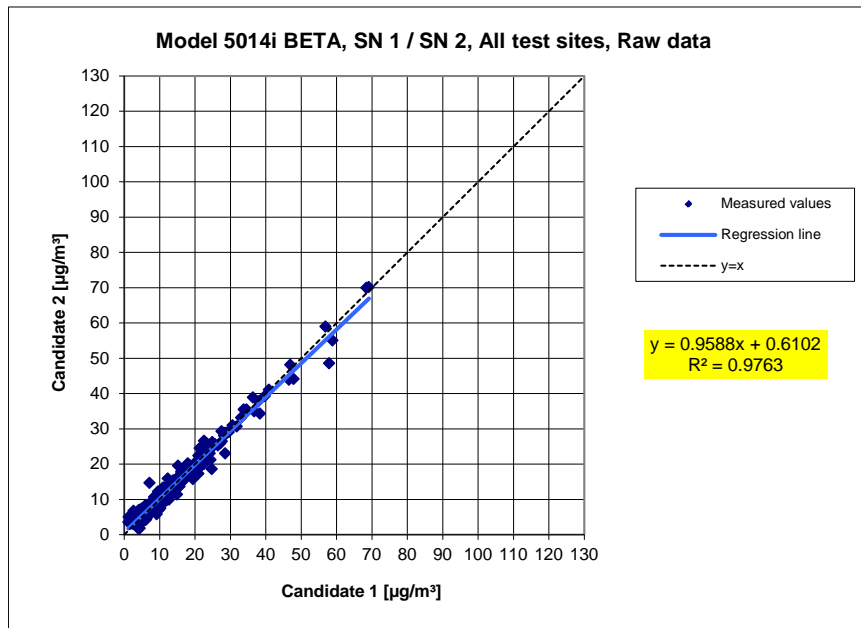
Minimum requirement fulfilled? yes

## 6.6 Detailed presentation of test results

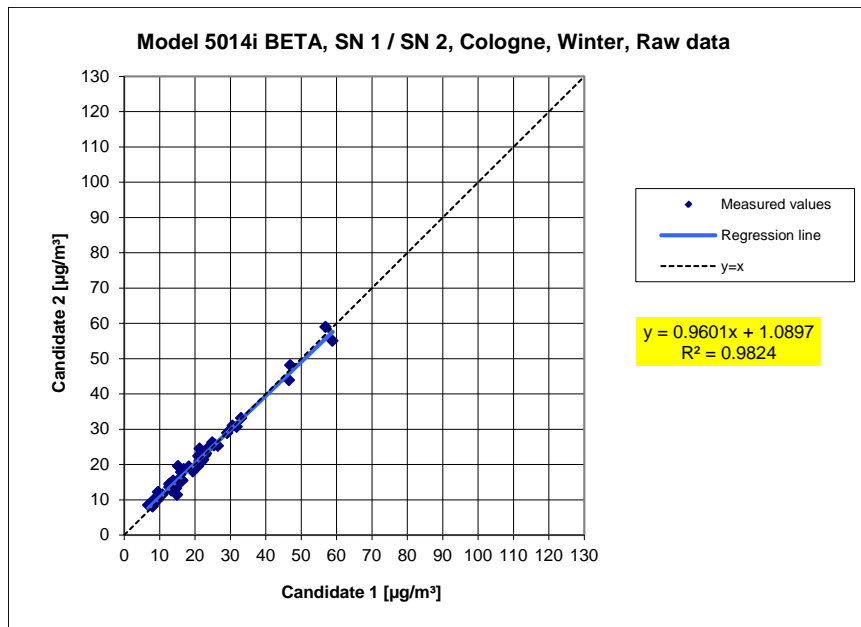
Table 34 shows the values calculated for the uncertainty between systems under test  $u_{bs}$ . The graphical representation is displayed in Figure 36 to Figure 42.

**Table 34:** Uncertainty between systems under test  $u_{bs}$  for candidates SN 1 and SN 2, measured component PM<sub>2.5</sub>

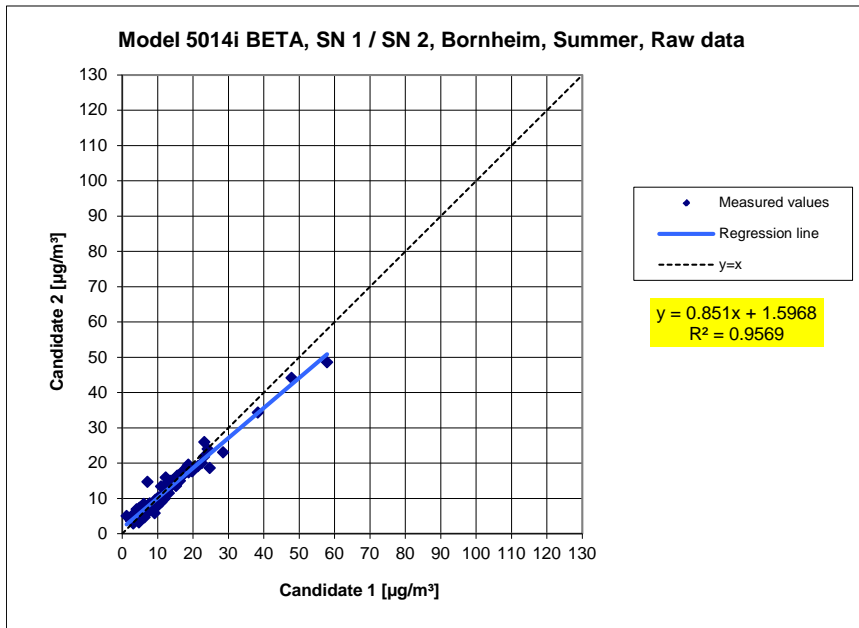
Candidate	Test site	No. of values	Uncertainty $u_{bs}$
SN			$\mu\text{g}/\text{m}^3$
<b>SN 1 / SN 2</b>	<b>All test sites</b>	<b>251</b>	<b>1.24</b>
Single test sites			
SN 1 / SN 2	Cologne, winter	52	1.07
SN 1 / SN 2	Bornheim, summer	91	1.51
SN 1 / SN 2	Bornheim, winter	49	1.07
SN 1 / SN 2	Teddington, summer	59	1.05
Classification over reference value			
<b>SN 1 / SN 2</b>	<b>Values <math>\geq 18 \mu\text{g}/\text{m}^3</math></b>	<b>51</b>	<b>1.69</b>
SN 1 / SN 2	Values $< 18 \mu\text{g}/\text{m}^3$	156	1.15



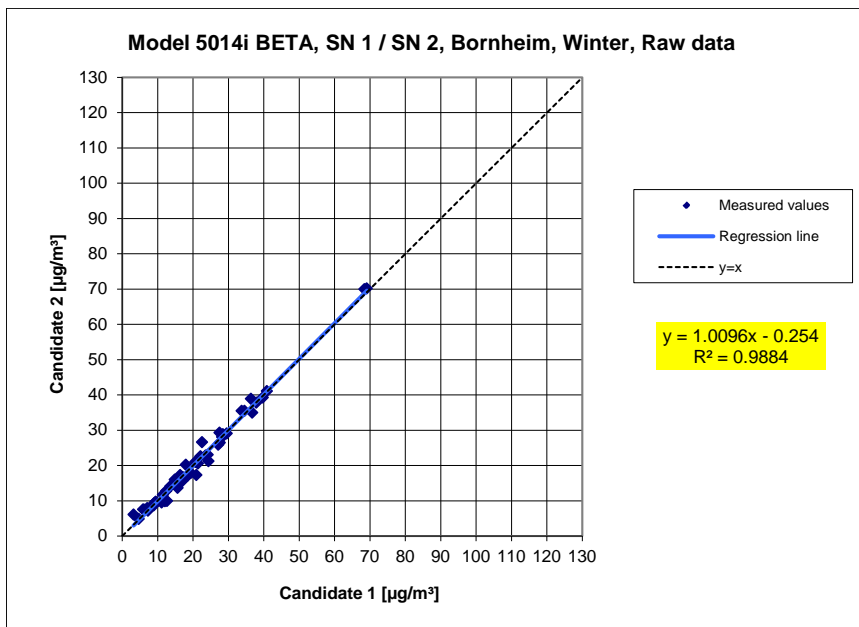
**Figure 36:** Results of the parallel measurements with the candidates SN 1 / SN 2, measured component PM<sub>2.5</sub>, all test sites



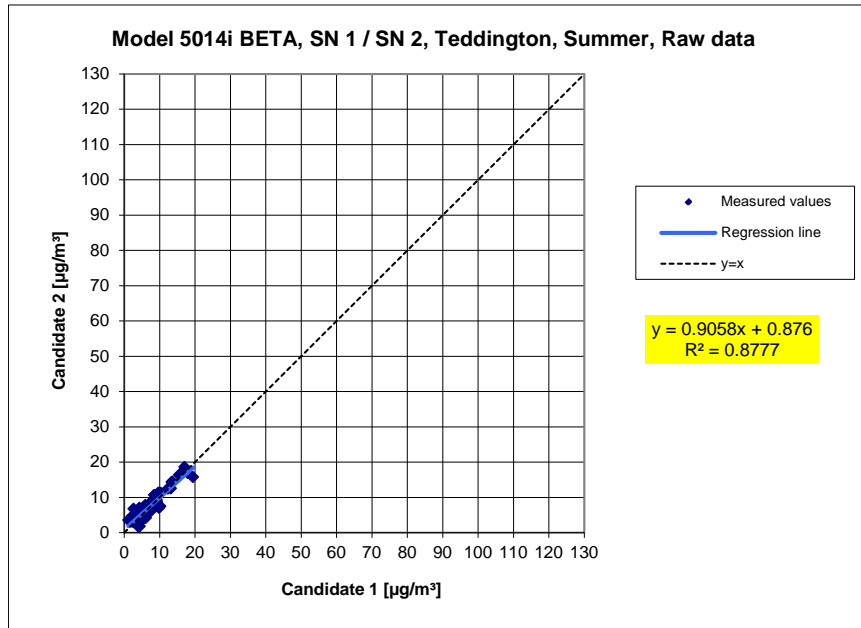
**Figure 37:** Results of the parallel measurements with the candidates SN 1 / SN 2, measured component PM<sub>2.5</sub>, test site Cologne (winter)



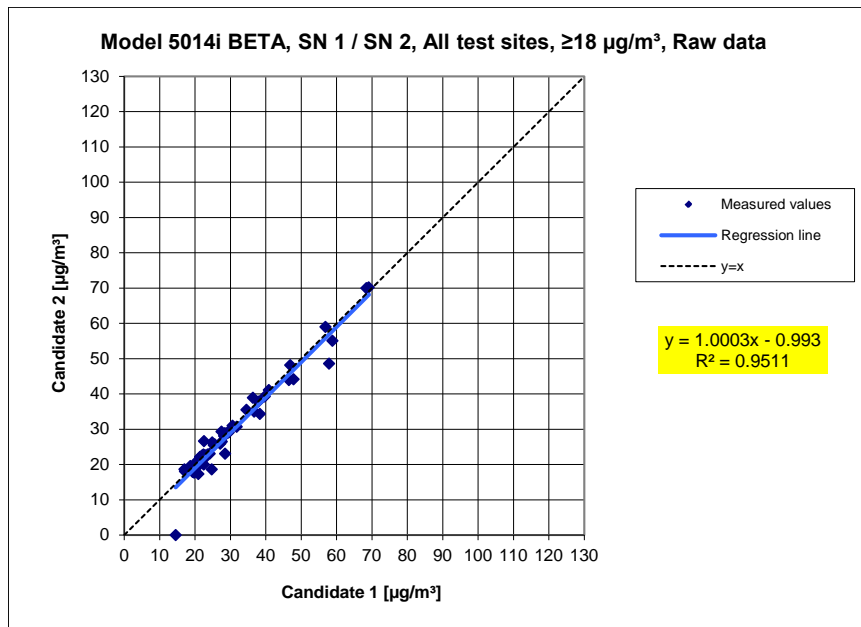
**Figure 38:** Results of the parallel measurements with the candidates SN 1 / SN 2, measured component PM<sub>2.5</sub>, test site Bornheim (summer)



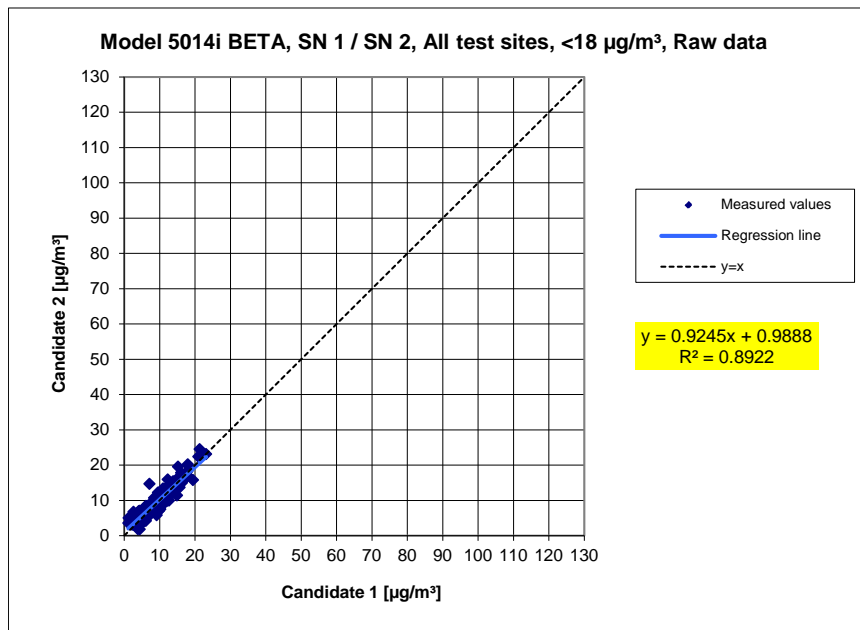
**Figure 39:** Results of the parallel measurements with the candidates SN 1 / SN 2, measured component PM<sub>2.5</sub>, test site Bornheim (winter)



**Figure 40:** Results of the parallel measurements with the candidates SN 1 / SN 2, measured component PM<sub>2.5</sub>, test site Teddington (summer)



**Figure 41:** Results of the parallel measurements with the candidates SN 1 / SN 2, measured component PM<sub>2.5</sub>, all test sites, values ≥ 18 µg/m<sup>3</sup>



**Figure 42:** Results of the parallel measurements with the candidates SN 1 / SN 2, measured component PM<sub>2.5</sub>, all test sites, values < 18 µg/m<sup>3</sup>

## 6.1 5.4.10 Calculation of the expanded uncertainty of the instruments

*For the test of PM<sub>2.5</sub> measuring systems the equivalency with the reference method shall be demonstrated according to chapter 9.5.3.2 to chapter 9.6 of the guidance document „Demonstration of Equivalence of Ambient Air Monitoring Methods“ in the field test at least at four sampling sites representative of the future application. The maximum expanded uncertainty of the systems under test shall be compared with data quality objectives according to Annex A of Standard VDI 4202 Part 1 (September 2010).*

## 6.2 Equipment

Auxiliary equipment described in Section 5.

## 6.3 Performance of test

The test was carried out at four different comparisons during field test. Different seasons and varying concentrations for PM<sub>2.5</sub> were taken into consideration.

Of the complete dataset, at least 20 % of the concentration values determined with the reference method shall be greater than the upper assessment threshold according to 2008/50/EC [7]. For PM<sub>2.5</sub> the upper assessment threshold is at 17 µg/m<sup>3</sup>.

At each comparison campaign at least 40 valid data pairs were determined. Of the complete dataset (4 test sites, 215 valid data pairs for SN 1, 219 valid data pairs for SN 2) a total of 28 % of the measured values are above the upper assessment threshold of 17 µg/m<sup>3</sup> for PM<sub>2.5</sub>. The measured concentrations were referred to ambient conditions.

## 6.4 Evaluation

[Point 9.5.3.2] The calculation of the in-between uncertainty of the reference devices  $u_{\text{ref}}$  is carried out prior to the calculation of the expanded uncertainty of the candidates.

The in-between uncertainty of the reference devices  $u_{\text{ref}}$  is determined analogous to the uncertainty between candidates and shall be  $\leq 2 \mu\text{g}/\text{m}^3$ .

The evaluated results are illustrated in “Detailed presentation of test results” of this test item.

A linear correlation  $y_i = a + bx_i$  is assumed between the results of both methods in order to evaluate the comparability of the candidates  $y$  and the reference procedure  $x$ . The correlation between the average values of the reference devices and the candidates is established by orthogonal regression.

Regression is calculated for:

- All test sites and comparisons together
- Each test site and comparison separately
- 1 dataset with measured values  $\text{PM}_{2.5} \geq 18 \mu\text{g}/\text{m}^3$  (Basis: average value of reference measurement)

For further evaluation, the results of the uncertainty  $u_{\text{c}_s}$  of the candidates compared with the reference method are described with the following equation, which describes  $u_{\text{CR}}$  as a function of the PM concentration  $x_i$ :

$$u_{\text{CR}}^2(y_i) = \frac{\text{RSS}}{(n-2)} - u^2(x_i) + [a + (b-1)x_i]^2$$

With  $\text{RSS} =$  Sum of the (relative) residuals from orthogonal regression



$u(x_i)$  = random uncertainty of the reference procedure if value  $u_{bs}$ , which is calculated for using the candidates, can be used in this test (refer to point 6.1 5.4.9 Determination of uncertainty between systems under test  $u_{bs}$ )

Algorithms for the calculation of ordinate intercept  $a$  as well as slope  $b$  and its variances by orthogonal regression are described in detail in annex B of [4].

The sum of the (relative) residuals RSS is calculated by the following equation:

$$RSS = \sum_{i=1}^n (y_i - a - bx_i)^2$$

Uncertainty  $u_{CR}$  is calculated for:

- All test sites and comparisons together
- Each test site and comparison individually
- 1 dataset with measured values PM<sub>2.5</sub> ≥ 18 µg/m<sup>3</sup> (Basis: average values of the reference measurement)

Preconditions for acceptance of the full dataset are that:

- The slope  $b$  is insignificantly different from 1:  $|b - 1| \leq 2 \cdot u(b)$

and

- The intercept  $a$  is insignificantly different from 0:  $|a| \leq 2 \cdot u(a)$

Where  $u(b)$  and  $u(a)$  are the standard uncertainties of the slope and intercept, respectively calculated as the square root of their variances. If these preconditions are not met, the candidate method may be calibrated according to point 9.7 of the Guide (refer to 6.1 5.4.11

Application of correction factors and terms. The calibration shall only be applied to the full dataset.

[Point 9.5.4] The combined uncertainty of the candidates  $w_{c,CM}$  is calculated for each dataset by combining the contributions from 9.5.3.1 and 9.5.3.2 according to the following equation:

$$w_{c,CM}^2(y_i) = \frac{u_{CR}^2(y_i)}{y_i^2}$$

For each dataset, the uncertainty  $w_{c,CM}$  is calculated at the level of  $y_i = 30 \mu\text{g}/\text{m}^3$  for PM<sub>2.5</sub>.

[Point 9.5.5] The expanded relative uncertainty of the results of the candidates is calculated for each dataset by multiplication of  $w_{c,CM}$  with a coverage factor  $k$  according to the following equation:

$$W_{CM} = k \cdot w_{c,CM}$$

In practice:  $k=2$  for large  $n$

[Point 9.6] The highest resulting uncertainty  $W_{CM}$  is compared and assessed with the requirements on data quality of ambient air measurements according to EU Standard [7]. Two results are possible:

1.  $W_{CM} \leq W_{d,qo}$  → Candidate method is accepted as equivalent to the standard method.
2.  $W_{CM} > W_{d,qo}$  → Candidate method is not accepted as equivalent to the standard method.

The specified expanded relative uncertainty  $W_{d,qo}$  for particulate matter is 25 % [7].

## 6.5 Assessment

The determined uncertainties  $W_{CM}$  without application of correction factors lay for all observed datasets below the defined expanded relative uncertainty  $W_{d,qo}$  of 25 % for fine dust.

Minimum requirement fulfilled? yes

The following Table 35 shows an overview of the results of the equivalence check for the candidate Model 5014i Beta for PM<sub>2.5</sub>. In case that a criterion is fulfilled or not the text is represented in green or red. Furthermore, the five criteria from chapter 6.1 Methodology of the equivalence check (modules 5.4.9 – 5.4.11) are taken into account; the related cells are highlighted in colour.

**Table 35:** Overview equivalence test of Model 5014i Beta for PM<sub>2.5</sub>






PM2.5 5014i Beta	28% ≥ 17 µg m-3	Orthogonal Regression				Between Instrument Uncertainties	
	WCM / %	nc-s	r2	Slope (b) +/- ub	Intercept (a) +/- ua	Reference	Candidate
All Data	19.9	207	0.972	1.070 +/- 0.013	0.216 +/- 0.220	0.61	1.24
< 18 µg m-3	25.1	156	0.856	1.113 +/- 0.034	-0.058 +/- 0.330	0.56	1.15
≥ 18 µg m-3	20.6	51	0.965	1.100 +/- 0.029	-0.952 +/- 0.902	0.76	1.69

SN1	Dataset	Orthogonal Regression				Limit Value of 30 µg m-3	
		nc-s	r2	Slope (b) +/- ub	Intercept (a) +/- ua	WCM / %	% ≥ 17 µg m-3
Individual Datasets	Bornheim Winter	41	0.979	1.090 +/- 0.025	-0.155 +/- 0.620	21.28	56.1
	Cologne Winter	41	0.976	1.083 +/- 0.027	0.331 +/- 0.602	22.45	53.7
	Bornheim Summer	78	0.940	1.078 +/- 0.030	0.247 +/- 0.422	22.61	15.4
	Teddington Summer	55	0.834	1.023 +/- 0.057	0.028 +/- 0.487	13.12	3.6
Combined Datasets	< 18 µg m-3	163	0.842	1.138 +/- 0.035	-0.383 +/- 0.347	28.01	4.3
	≥ 18 µg m-3	52	0.963	1.118 +/- 0.030	-1.220 +/- 0.928	22.50	100.0
	All Data	215	0.969	1.089 +/- 0.013	-0.062 +/- 0.229	22.01	27.4

SN2	Dataset	Orthogonal Regression				Limit Value of 30 µg m-3	
		nc-s	r2	Slope (b) +/- ub	Intercept (a) +/- ua	WCM / %	% ≥ 17 µg m-3
Individual Datasets	Bornheim Winter	41	0.969	1.110 +/- 0.031	-0.584 +/- 0.768	24.45	56.1
	Cologne Winter	43	0.971	1.046 +/- 0.028	1.333 +/- 0.615	22.24	53.5
	Bornheim Summer	70	0.941	0.923 +/- 0.027	1.735 +/- 0.387	13.46	15.7
	Teddington Summer	65	0.787	0.982 +/- 0.057	0.613 +/- 0.483	12.50	3.1
Combined Datasets	< 18 µg m-3	168	0.810	1.125 +/- 0.038	-0.031 +/- 0.367	28.37	4.8
	≥ 18 µg m-3	51	0.951	1.099 +/- 0.035	-1.296 +/- 1.076	21.92	100.0
	All Data	219	0.960	1.056 +/- 0.014	0.430 +/- 0.247	20.38	26.9

KEY	
	Criterion 1
	Criterion 2
	Criterion 3
	Criterion 4
	Criterion 5
	Other

The check of the five criteria from chapter 6.1 Methodology of the equivalence check (modules 5.4.9 – 5.4.11) resulted as follows:

- Criterion 1: More than 20 % of the data are greater than 17 µg/m<sup>3</sup>.
- Criterion 2: The in-between uncertainty of the candidates is smaller than 2.5 µg/m<sup>3</sup>.
- Criterion 3: The in-between uncertainty of the reference is smaller than 2.0 µg/m<sup>3</sup>.

- Criterion 4: All of the expanded uncertainties are below 25 %.
- Criterion 5: The slopes used for evaluation of the complete dataset are significantly greater than the permissible values for SN 1 and SN 2.
- Other: The evaluation of the complete dataset for both candidates together shows that the AMS demonstrates a very good correlation with the reference method with a slope of 1.070 and an intercept of 0.216 at an expanded total uncertainty of 19.9 %

The January 2010 version of The Guidance is ambiguous with respect to which slope and intercept should be used to correct a candidate should it fail the test of equivalence. After communication with the convenor of the EC working group, which is responsible for setting up the Guide (Mr Theo Hafkenscheid), it was decided that the requirement of the November 2005 version of the Guidance are still valid, and that the slope and intercept from the orthogonal regression of all the paired data should be used. These are shaded gold and marked 'other' in the key on the above Table 35.

The 2006 UK Equivalence Report [8] highlighted that this was a flaw in the mathematics required for equivalence as per the November 2005 version of The Guidance as it penalised instruments that were more accurate (Appendix E Section 4.2 therein). This same flaw is copied in the January 2010 version. It is the opinion of TÜV Rheinland and their UK partners that the Model 5014i Beta measuring system for PM<sub>2.5</sub> is indeed being penalised by the mathematics for being accurate. It is proposed that the same pragmatic approach is taken here that was previously undertaken in earlier studies.

Therefore, according to Table 35, the slope offset should be corrected for PM<sub>2.5</sub> due to its significance. Nonetheless it should be noted that the determined uncertainties  $W_{CM}$  lie below the specified expanded relative uncertainty  $W_{dqo}$  of 25 % for particulate matter for all datasets considered without application of correction factors.

In this particular case the slope for the complete dataset comparison is 1.070. Therefore, under point 6.1 5.4.11 Application of correction factors and terms, an additional evaluation using the respective calibration factor for the datasets is carried out.

The intercept for the complete dataset comparison is 0.216.

The reworked version of the Guide of January 2010 requires that when operating in networks, a candidate method needs to be tested annually at a number of sites and that the number of the instruments to be tested is dependent on the expanded measurement uncertainty of the device. The respective realisation is the responsibility of the network operator or of the responsible authority of the member state. However, TÜV Rheinland and their UK partners recommend that the expanded uncertainty for the full dataset is referred to for this, i.e. 19.9 %, which again would require an annual test at 4 measurement sites (Guide [4], chapter 9.9.2, Table 6).

## 6.6 Detailed presentation of test results

Table 36 presents an overview on the uncertainties between the reference devices  $u_{ref}$  from the field tests. In Table 37, the results of the equivalence test including the determined expanded measuring uncertainties  $W_{CM}$  from the field test are summarised.

**Table 36:** Uncertainty between the reference devices  $u_{ref}$  for PM<sub>2.5</sub>

Reference device	Test site	Amount values	Uncertainty $u_{bs}$
No.			$\mu\text{g}/\text{m}^3$
1 / 2	Cologne, winter	48	0.58
1 / 2	Bornheim, summer	87	0.66
1 / 2	Bornheim, winter	41	0.91
1 / 2	Teddington, summer	65	0.17
1 / 2	All test sites	241	0.61

The uncertainty between the reference devices  $u_{ref}$  is  $< 2 \mu\text{g}/\text{m}^3$  for all test sites.

**Table 37:** Summary of the results of the equivalence test, SN 1 & SN 2, measured component PM<sub>2.5</sub>, raw data

PM <sub>2.5</sub> 5014i Beta	28% ≥ 17 µg m <sup>-3</sup>	Orthogonal Regression				Between Instrument Uncertainties	
	W <sub>CM</sub> / %	n <sub>C-S</sub>	r <sup>2</sup>	Slope (b) +/- u <sub>b</sub>	Intercept (a) +/- u <sub>a</sub>	Reference	Candidate
All Data	19.9	207	0.972	1.070 +/- 0.013	0.216 +/- 0.220	0.61	1.24
< 18 µg m <sup>-3</sup>	25.1	156	0.856	1.113 +/- 0.034	-0.058 +/- 0.330	0.56	1.15
≥ 18 µg m <sup>-3</sup>	20.6	51	0.965	1.100 +/- 0.029	-0.952 +/- 0.902	0.76	1.69

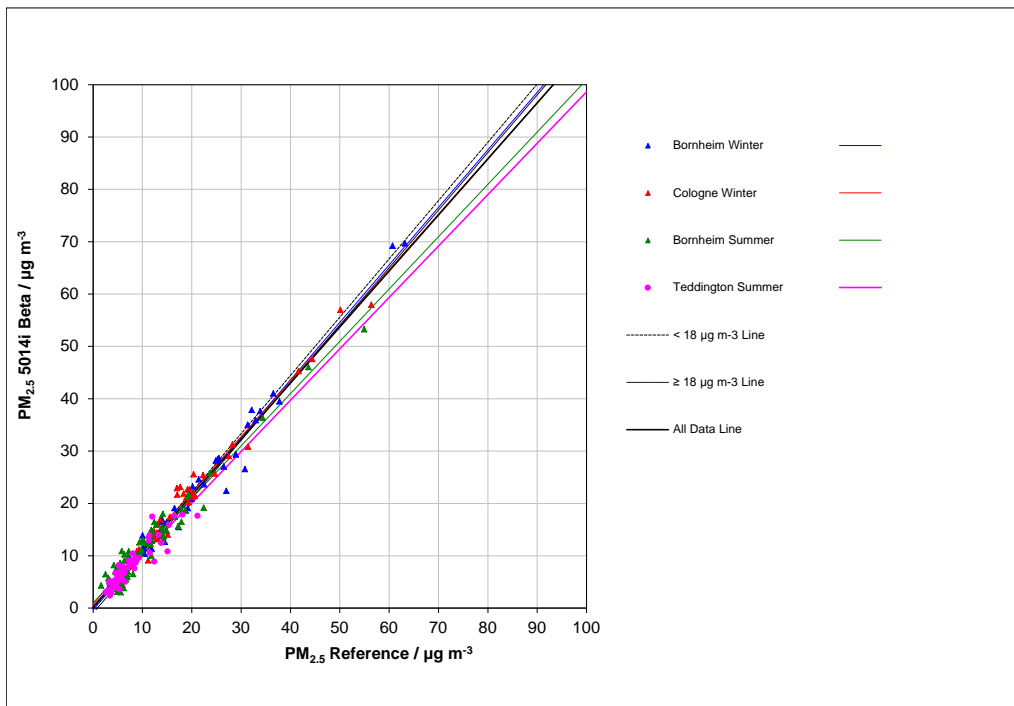
  

SN1	Dataset	Orthogonal Regression				Limit Value of 30 µg m <sup>-3</sup>	
		n <sub>C-S</sub>	r <sup>2</sup>	Slope (b) +/- u <sub>b</sub>	Intercept (a) +/- u <sub>a</sub>	W <sub>CM</sub> / %	% ≥ 17 µg m <sup>-3</sup>
Individual Datasets	Bornheim Winter	41	0.979	1.090 +/- 0.025	-0.155 +/- 0.620	21.28	56.1
	Cologne Winter	41	0.976	1.083 +/- 0.027	0.331 +/- 0.602	22.45	53.7
	Bornheim Summer	78	0.940	1.078 +/- 0.030	0.247 +/- 0.422	22.61	15.4
	Teddington Summer	55	0.834	1.023 +/- 0.057	0.028 +/- 0.487	13.12	3.6
Combined Datasets	< 18 µg m <sup>-3</sup>	163	0.842	1.138 +/- 0.035	-0.383 +/- 0.347	28.01	4.3
	≥ 18 µg m <sup>-3</sup>	52	0.963	1.118 +/- 0.030	-1.220 +/- 0.928	22.50	100.0
	All Data	215	0.969	1.089 +/- 0.013	-0.062 +/- 0.229	22.01	27.4

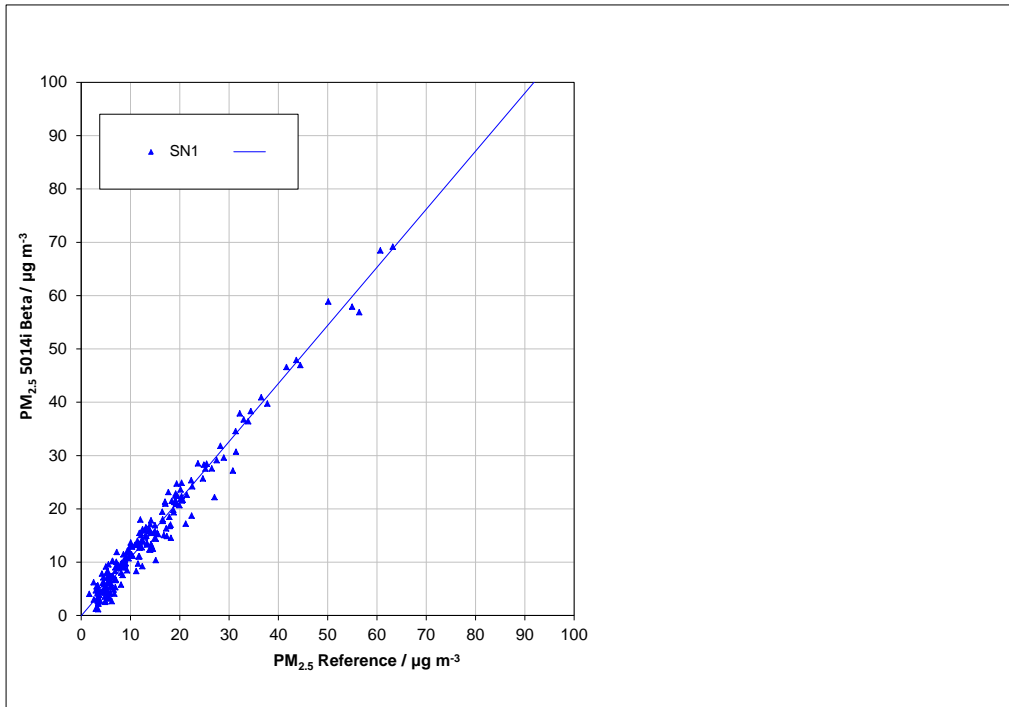
  

SN2	Dataset	Orthogonal Regression				Limit Value of 30 µg m <sup>-3</sup>	
		n <sub>C-S</sub>	r <sup>2</sup>	Slope (b) +/- u <sub>b</sub>	Intercept (a) +/- u <sub>a</sub>	W <sub>CM</sub> / %	% ≥ 17 µg m <sup>-3</sup>
Individual Datasets	Bornheim Winter	41	0.969	1.110 +/- 0.031	-0.584 +/- 0.768	24.45	56.1
	Cologne Winter	43	0.971	1.046 +/- 0.028	1.333 +/- 0.615	22.24	53.5
	Bornheim Summer	70	0.941	0.923 +/- 0.027	1.735 +/- 0.387	13.46	15.7
	Teddington Summer	65	0.787	0.982 +/- 0.057	0.613 +/- 0.483	12.50	3.1
Combined Datasets	< 18 µg m <sup>-3</sup>	168	0.810	1.125 +/- 0.038	-0.031 +/- 0.367	28.37	4.8
	≥ 18 µg m <sup>-3</sup>	51	0.951	1.099 +/- 0.035	-1.296 +/- 1.076	21.92	100.0
	All Data	219	0.960	1.056 +/- 0.014	0.430 +/- 0.247	20.38	26.9

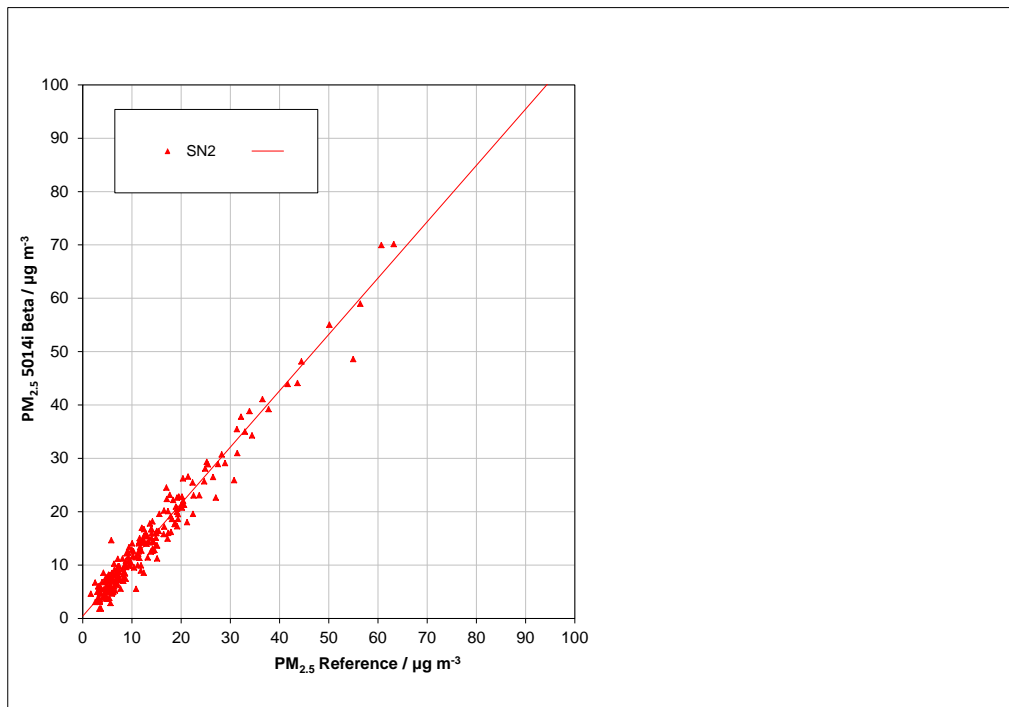
Report on the suitability test of the ambient air quality measuring system  
Model 5014i Beta with PM<sub>2.5</sub> pre-separator of the company Thermo Fisher  
Scientific for the component suspended particulate matter PM<sub>2.5</sub>,  
Report No.: 936/21209885/H



**Figure 43:** Reference vs. candidate, SN 1 & SN 2, measured component PM<sub>2.5</sub>, all test sites



**Figure 44:** Reference vs. candidate, SN 1, measured component PM<sub>2.5</sub>, all test sites



**Figure 45:** Reference vs. candidate, SN 2, measured component PM<sub>2.5</sub>, all test sites



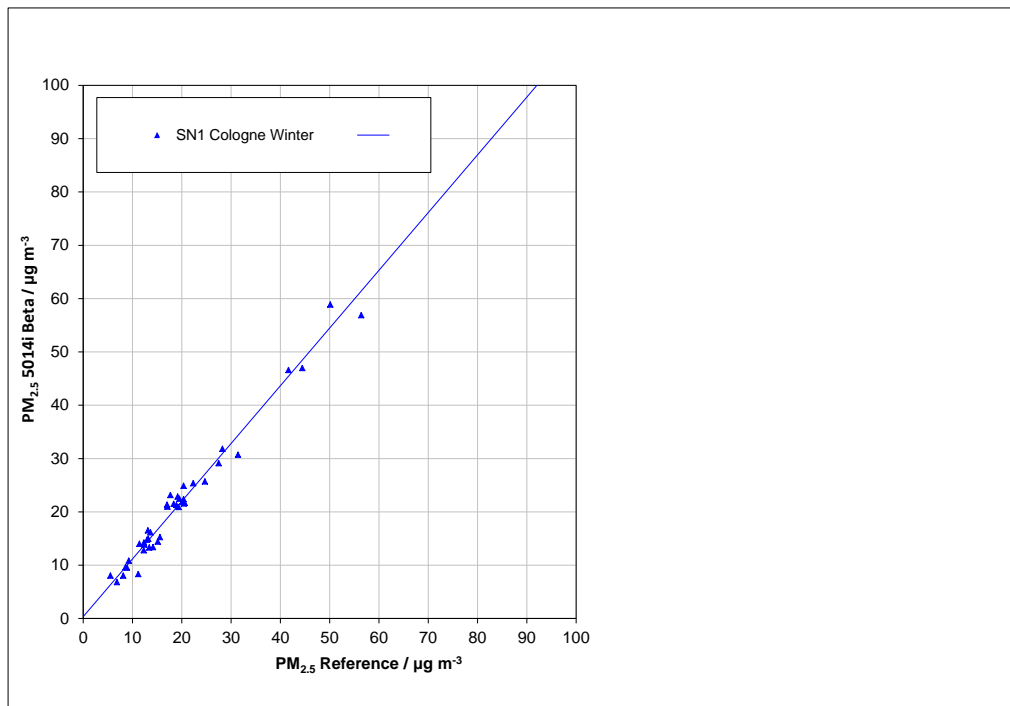


Figure 46: Reference vs. candidate, SN 1, measured component PM<sub>2.5</sub>, Cologne (winter)

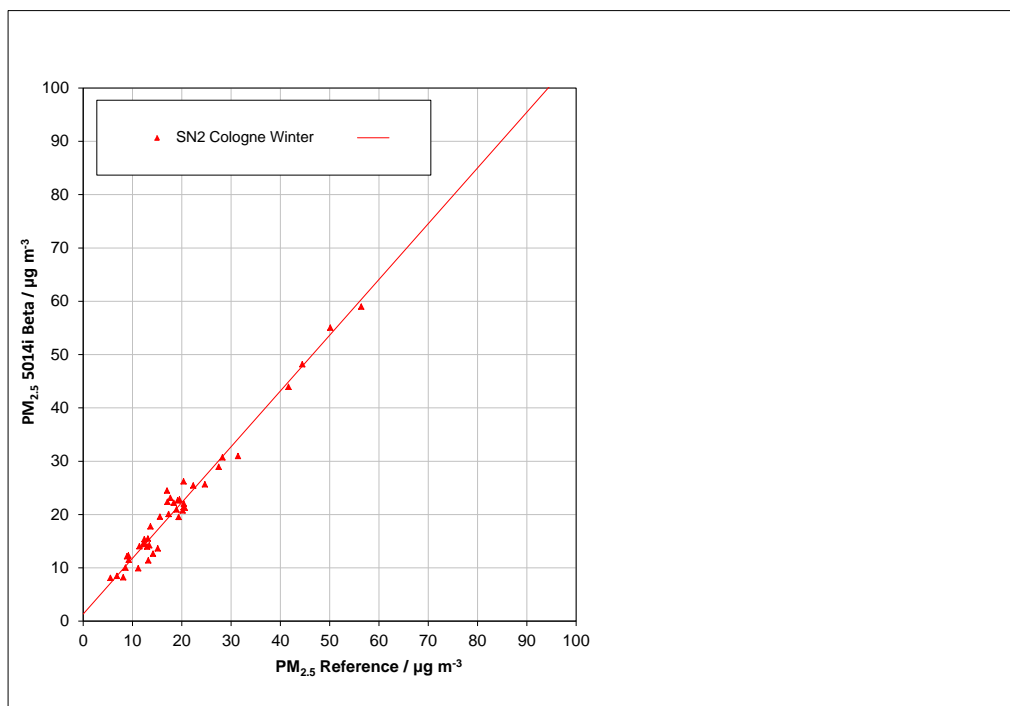
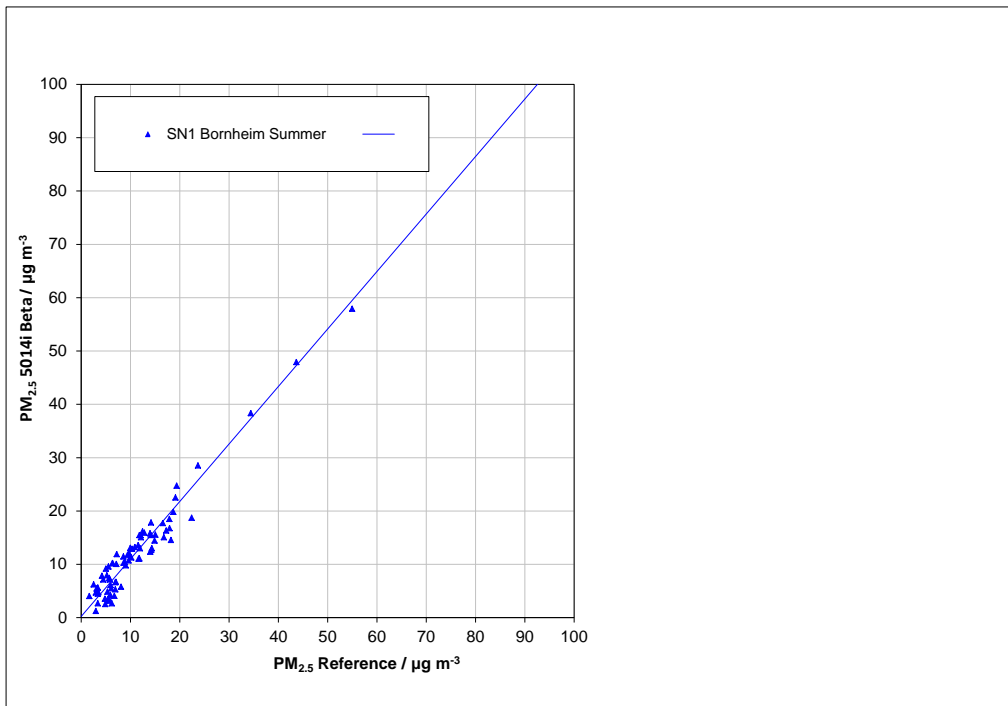
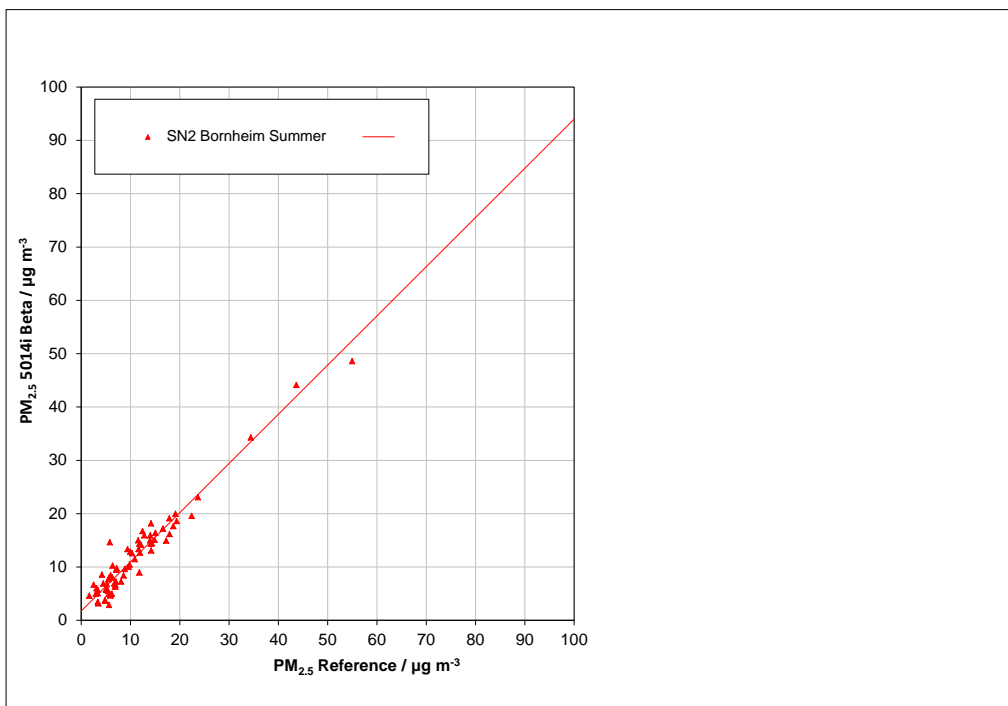


Figure 47: Reference vs. candidate, SN 2, measured component PM<sub>2.5</sub>, Cologne (winter)



**Figure 48:** Reference vs. candidate, SN 1, measured component PM<sub>2.5</sub>, Bornheim (summer)



**Figure 49:** Reference vs. candidate, SN 2, measured component PM<sub>2.5</sub>, Bornheim (summer)

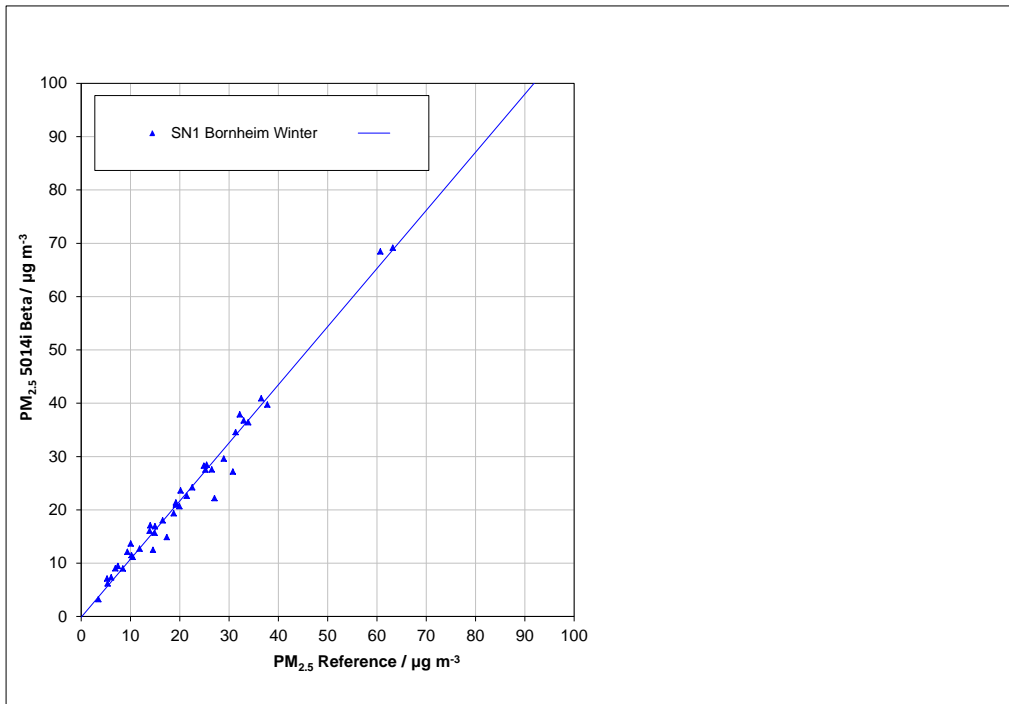


Figure 50: Reference vs. candidate, SN 1, measured component PM<sub>2.5</sub>, Bornheim (winter)

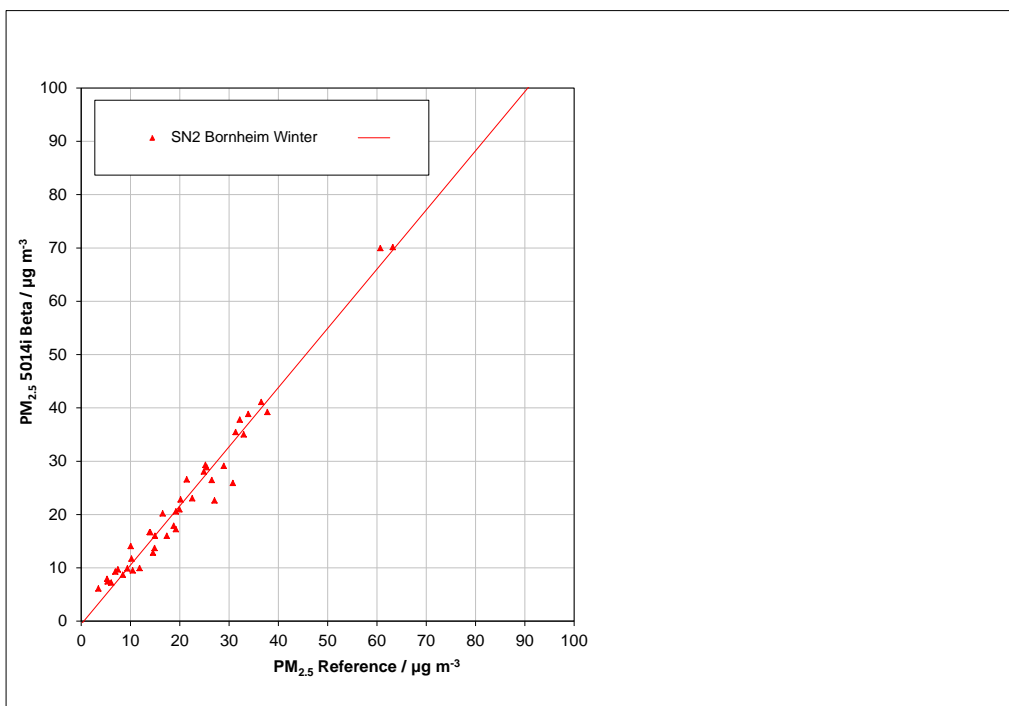
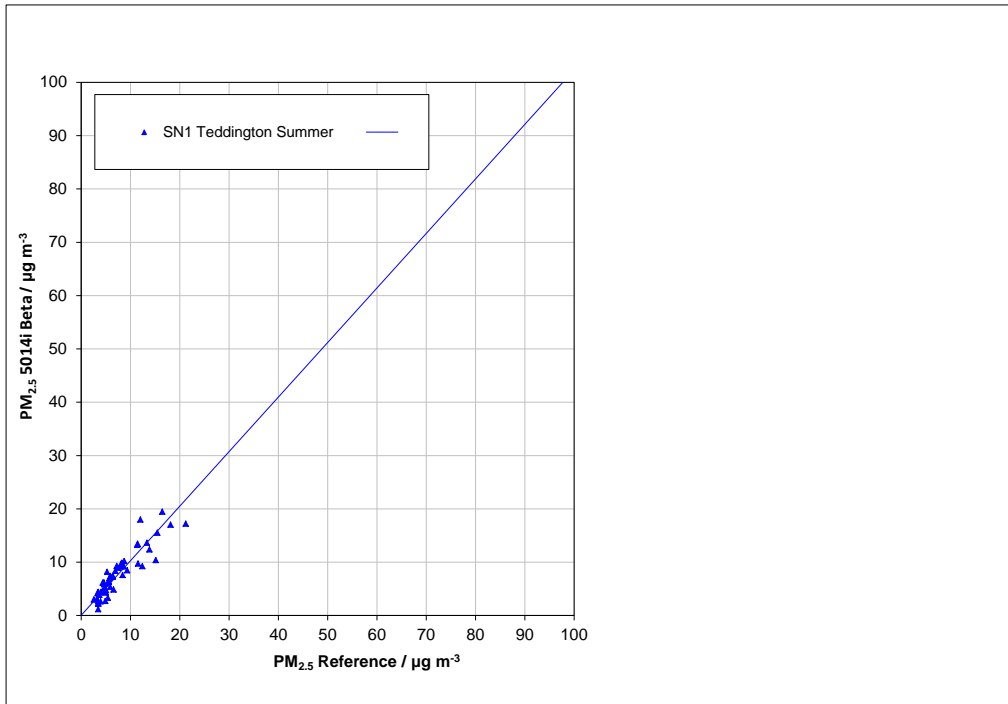
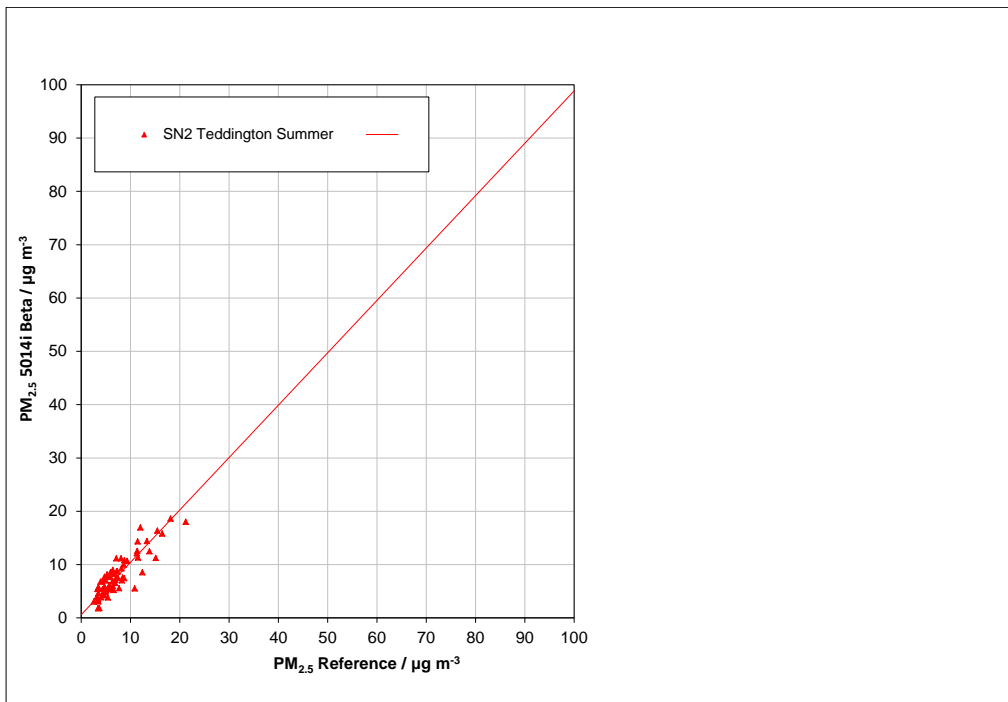


Figure 51: Reference vs. candidate, SN 2, measured component PM<sub>2.5</sub>, Bornheim (winter)



**Figure 52:** Reference vs. candidate, SN 1, measured component PM<sub>2.5</sub>, Teddington (summer)



**Figure 53:** Reference vs. candidate, SN 2, measured component PM<sub>2.5</sub>, Teddington (summer)

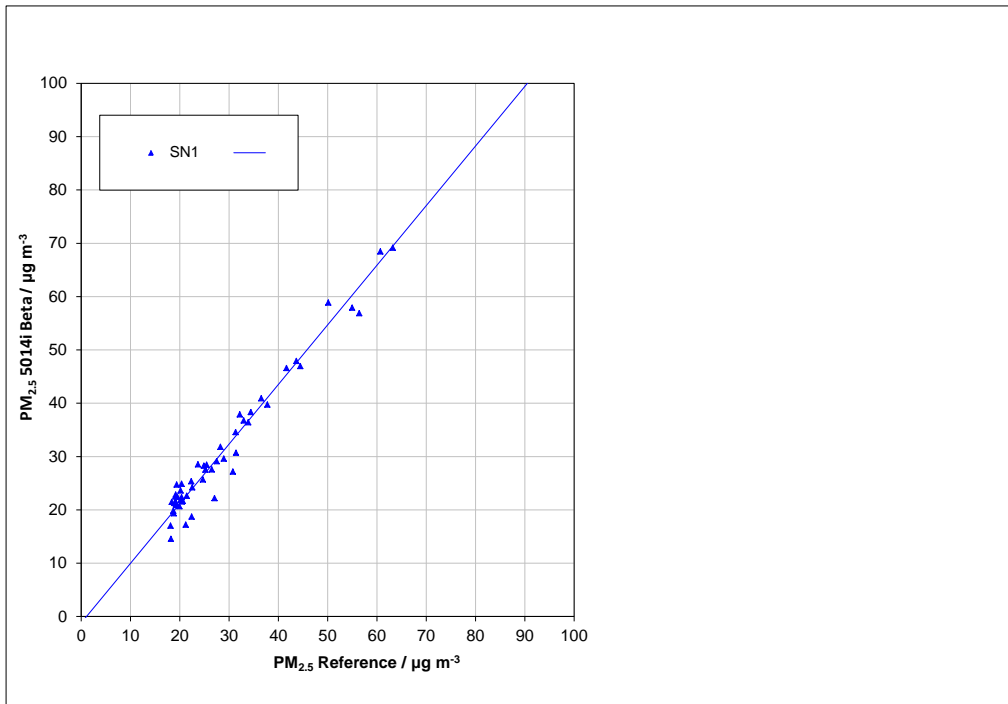


Figure 54: Reference vs. candidate, SN 1, measured component PM<sub>2.5</sub>, values  $\geq 18 \mu\text{g}/\text{m}^3$

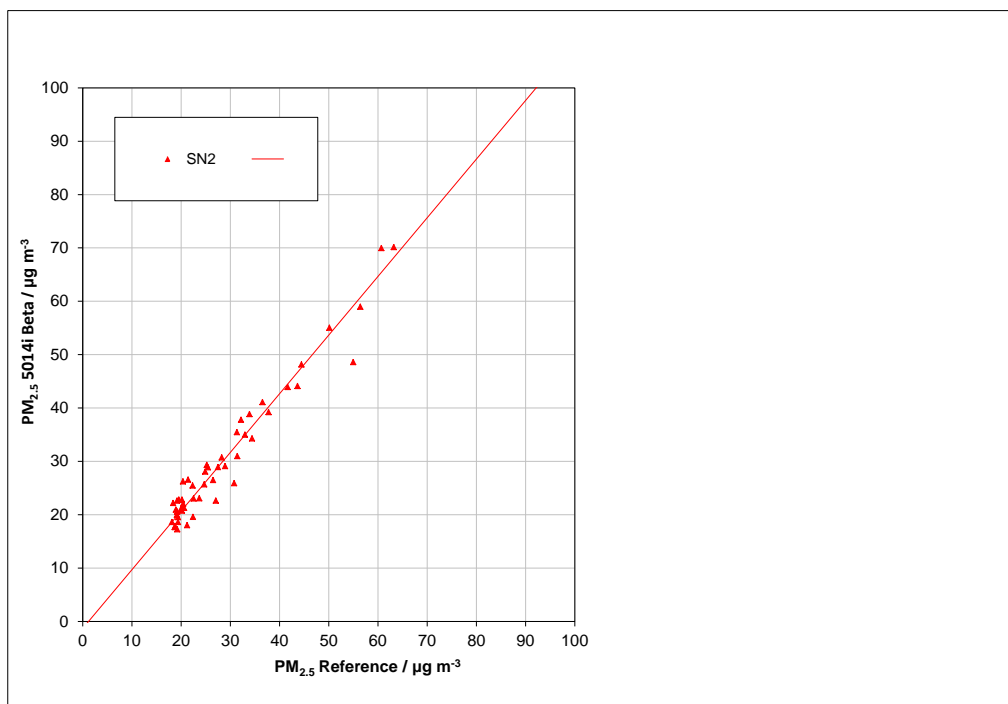


Figure 55: Reference vs. candidate, SN 2, measured component PM<sub>2.5</sub>, values  $\geq 18 \mu\text{g}/\text{m}^3$

## 6.1 5.4.11 Application of correction factors and terms

*If the highest resulting expanded uncertainty of the candidate method is larger than the expanded relative uncertainty, which is defined in the requirements on the data quality of ambient air measurements according to EU-Guideline [7], the application of correction factors or terms is permitted. The corrected values have to fulfil the requirements according to point 9.5.3.2 et seqq. of the Guide „Demonstration of Equivalence of Ambient Air Monitoring Methods“.*

### 6.2 Equipment

No additional equipment required.

### 6.3 Performance of test

Refer to module 5.4.10.

### 6.4 Evaluation

If evaluation of the raw data according to module 5.4.10 leads to a case where  $W_{CM} > W_{dqo}$ , which means that the candidate systems is not regarded equivalent to the reference method, it is permitted to apply a correction factor or term resulting from the regression equation obtained from the full dataset. The corrected values shall satisfy the requirements for all datasets or subsets (refer to module 5.4.10). Moreover, a correction factor may be applied even for  $W_{CM} \leq W_{dqo}$  in order to improve the accuracy of the candidate systems.

Three different cases may occur:

- a) Slope b not significantly different from 1:  $|b - 1| \leq 2u(b)$ ,  
intercept a significantly different from 0:  $|a| > 2u(a)$
- b) Slope b significantly different from 1:  $|b - 1| > 2u(b)$ ,  
intercept a not significantly different from 0:  $|a| \leq 2u(a)$
- c) Slope b significantly different from 1:  $|b - 1| > 2u(b)$   
intercept a significantly different from 0:  $|a| > 2u(a)$

With respect to a)

The value of the intercept a may be used as a correction term to correct all input values  $y_i$  according to the following equation.

$$y_{i,corr} = y_i - a$$

The resulting values of  $y_{i,corr}$  may then be used to calculate the following new terms by linear regression:

$$y_{i,corr} = c + dx_i$$

and

$$u_{c-s}^2(y_{i,corr}) = \frac{RSS}{(n-2)} - u^2(x_i) + [c + (d-1)x_i]^2 + u^2(a)$$

with  $u(a)$  = uncertainty of the original intercept  $a$ , the value of which has been used to obtain  $y_{i,corr}$ .

Algorithms for the calculation of intercepts as well as slopes and their variances by orthogonal regression are described in detail in annex B of [4]. RSS is determined analogue to the calculation in module 5.4.10.

With respect to b)

The value of the slope  $b$  may be used as a term to correct all input values  $y_i$  according to the following equation.

$$y_{i,corr} = \frac{y_i}{b}$$

The resulting values of  $y_{i,corr}$  may then be used to calculate the following new terms by linear regression:

$$y_{i,corr} = c + dx_i$$

and

$$u_{c-s}^2(y_{i,corr}) = \frac{RSS}{(n-2)} - u^2(x_i) + [c + (d-1)x_i]^2 + x_i^2 u^2(b)$$

with  $u(b)$  = uncertainty of the original slope  $b$ , the value of which has been used to obtain  $y_{i,corr}$ .

Algorithms for the calculation of intercepts as well as slopes and their variances by orthogonal regression are described in detail in annex B of [4]. RSS is determined analogue to the calculation in module 5.4.10.

With respect to c)

The values of the slope  $b$  and of the intercept  $a$  may be used as correction terms to correct all input values  $y_i$  according to the following equation.

$$y_{i,corr} = \frac{y_i - a}{b}$$

The resulting values of  $y_{i,corr}$  may then be used to calculate the following new terms by linear regression:

$$y_{i,corr} = c + dx_i$$

and

$$u_{c-s}^2(y_{i,corr}) = \frac{RSS}{(n-2)} - u^2(x_i) + [c + (d-1)x_i]^2 + x_i^2 u^2(b) + u^2(a)$$

with  $u(b)$  = uncertainty of the original slope  $b$ , the value of which has been used to obtain  $y_{i,corr}$  and with  $u(a)$  = uncertainty of the original intercept  $a$ , the value of which has been used to obtain  $y_{i,corr}$ .

Algorithms for the calculation of intercepts as well as slopes and their variances by orthogonal regression are described in detail in annex B of [4]. RSS is determined analogue to the calculation in module 5.4.10.

The values for  $u_{c-s,corr}$  are used for the calculation of the combined relative uncertainty of the candidate systems after correction according to the following equation:

$$w_{c,CM,corr}^2(y_i) = \frac{u_{c-s,corr}^2(y_i)}{y_i^2}$$

For the corrected dataset, uncertainty  $w_{c,CM,corr}$  is calculated at the daily limit value by taking  $y_i$  as the concentration at the limit value.

The expanded relative uncertainty  $W_{CM,corr}$  is calculated according to the following equation:

$$W_{CM,corr} = k \cdot w_{CM,corr}$$

In practice:  $k=2$  for large number of available experimental results

The highest resulting uncertainty  $W_{CM,corr}$  is compared and assessed with the requirements on data quality of ambient air measurements according to EU Standard [7]. Two results are possible:

1.  $W_{CM} \leq W_{d,qo}$  → Candidate method is accepted as equivalent to the standard method.
2.  $W_{CM} > W_{d,qo}$  → Candidate method is not accepted as equivalent to the standard method.

The specified expanded relative uncertainty  $W_{d,qo}$  for particulate matter is 25 % [7].

## 6.5 Assessment

The candidate systems fulfil the requirements on data quality of ambient air quality measurements during the test even without application of correction factors. A correction of the slope leads nevertheless to a significant improvement of the expanded measuring uncertainty of the full data comparison.

Minimum requirement fulfilled? yes



The evaluation of the full dataset for both candidates delivers, nevertheless, a significant slope (see Table 35).

The slope for the full dataset is 1.070 with an uncertainty of the slope of merely 0.013.

The 2006 UK Equivalence Report [8] highlighted that this was a flaw in the mathematics required for equivalence as per the November 2005 version of The Guidance as it penalised instruments that were more accurate (Appendix E Section 4.2 therein). This same flaw is copied in the January 2010 version. It is the opinion of TÜV Rheinland and their UK partners that the Model 5014i Beta measuring system for PM<sub>2.5</sub> is indeed being penalised by the mathematics for being accurate. It is proposed that the same pragmatic approach is taken here that was previously undertaken in earlier studies.

The slope for the full dataset is 1.070. For this reason, a slope correction of the entire dataset was performed and evaluated again with the corrected values. All datasets fulfil the requirements on data quality after the correction. The measurement uncertainty was improved significantly. A slight worsening could only be observed at the test site "Teddington (summer)" for SN 1 as well as "Bornheim (summer)" and "Teddington (summer)" for SN 2 (see Table 38 in comparison to Table 35).

The version of the Guide of January 2010 requires that when operating in networks, a candidate method needs to be tested annually at a number of sites corresponding to the highest expanded uncertainty found during equivalence testing. These criteria are banded in 5 % steps (Guide [4], point 9.9.2, Table 6). We have to bear in mind that the highest determined expanded uncertainty lies in the range 10 % to 15 % after the correction of the slope.

The respective realisation of the above mentioned requirement on on-going QA/QC in networks is the responsibility of the network operator or of the responsible authority of the member state. However, TÜV Rheinland and their UK partners recommend that the expanded uncertainty for the full dataset is referred to for this, namely 19.9 % (uncorrected dataset) and 12.0 % (dataset after slope correction), which again would require an annual test at 4 and 3 measurement sites respectively.

## 6.6 Detailed presentation of test results

Table 38 shows the results of the evaluations of the equivalence check after the application of the correction factor for the slope on the complete dataset.

**Table 38:** Summary of the results of the equivalence check, SN 1 & SN 2, after slope correction

PM2.5 5014i Beta Slope Corrected	28% ≥ 17 µg m-3	Orthogonal Regression				Between Instrument Uncertainties	
	W <sub>CM</sub> / %	n <sub>C-S</sub>	r <sup>2</sup>	Slope (b) +/- u <sub>b</sub>	Intercept (a) +/- u <sub>a</sub>	Reference	Candidate
All Data	12.0	207	0.972	0.999 +/- 0.012	0.215 +/- 0.205	0.61	1.16
< 18 µg m-3	13.1	156	0.856	1.035 +/- 0.032	-0.005 +/- 0.309	0.56	1.07
≥ 18 µg m-3	14.6	51	0.965	1.026 +/- 0.027	-0.855 +/- 0.843	0.76	1.58

SN1	Dataset	Orthogonal Regression				Limit Value of 30 µg m-3	
		n <sub>C-S</sub>	r <sup>2</sup>	Slope (b) +/- u <sub>b</sub>	Intercept (a) +/- u <sub>a</sub>	W <sub>CM</sub> / %	% ≥ 17 µg m-3
Individual Datasets	Bornheim Winter	41	0.979	1.018 +/- 0.023	-0.130 +/- 0.580	12.30	56.1
	Cologne Winter	41	0.976	1.011 +/- 0.025	0.325 +/- 0.563	12.47	53.7
	Bornheim Summer	78	0.940	1.005 +/- 0.028	0.254 +/- 0.394	14.12	15.4
	Teddington Summer	55	0.834	0.950 +/- 0.053	0.071 +/- 0.455	14.99	3.6
Combined Datasets	< 18 µg m-3	163	0.842	1.057 +/- 0.033	-0.301 +/- 0.325	15.20	4.3
	≥ 18 µg m-3	52	0.963	1.044 +/- 0.028	-1.102 +/- 0.867	15.36	100.0
	All Data	215	0.969	1.017 +/- 0.012	-0.043 +/- 0.214	13.05	27.4

SN2	Dataset	Orthogonal Regression				Limit Value of 30 µg m-3	
		n <sub>C-S</sub>	r <sup>2</sup>	Slope (b) +/- u <sub>b</sub>	Intercept (a) +/- u <sub>a</sub>	W <sub>CM</sub> / %	% ≥ 17 µg m-3
Individual Datasets	Bornheim Winter	41	0.969	1.036 +/- 0.029	-0.522 +/- 0.717	15.84	56.1
	Cologne Winter	43	0.971	0.977 +/- 0.026	1.265 +/- 0.575	12.81	53.5
	Bornheim Summer	70	0.941	0.860 +/- 0.026	1.641 +/- 0.362	20.89	15.7
	Teddington Summer	65	0.787	0.910 +/- 0.053	0.631 +/- 0.451	18.17	3.1
Combined Datasets	< 18 µg m-3	168	0.810	1.044 +/- 0.035	0.040 +/- 0.343	15.74	4.8
	≥ 18 µg m-3	51	0.951	1.025 +/- 0.033	-1.160 +/- 1.005	17.88	100.0
	All Data	219	0.960	0.985 +/- 0.013	0.420 +/- 0.230	13.92	26.9

**6.1 5.5 Requirements on multiple-component measuring systems**

*Multiple-component measuring systems shall comply with the requirements set for each component, also in the case of simultaneous operation of all measuring channels.*

**6.2 Equipment**

Not applicable.

**6.3 Performance of test**

Not applicable.

**6.4 Evaluation**

Not applicable.

**6.5 Assessment**

Not applicable.

Minimum requirement fulfilled? -

**6.6 Detailed presentation of test results**

Not applicable.

## **7. Recommendations for practical use**

### **Works in the maintenance interval (4 weeks)**

The following procedures are required to be undertaken at regular intervals:

- Regular visual inspection / telemetric monitoring
- Check of system status
- Check of error messages
- Contamination check
- Check of the instrument functions according to the instructions of the manufacturer
- Maintenance of the sampling inlet according to the instructions of the manufacturer

For the rest, the manufacturer's directions and recommendations shall be followed.

### Further maintenance works

The following works are necessary in addition to the regular works in the maintenance interval:

- Inspection of filter tape supply – one filter tape is enough for approx. 650 filter tape changes per roll (approx. 215 days at cycles of 8 hours). Semi-annual filter tape changes are expected to be sufficient under normal conditions (no unscheduled filter changes due to significantly high dust concentrations). The “Filter Tape Counter” function allows for monitoring the current number of filter tape changes as well as configuring alarm thresholds which remind the user of upcoming changes.
- An inspection of the sensors for ambient temperature and ambient pressure shall be carried out every three months according to the manufacturer’s specifications.
- A flow rate check must be performed every three months according to the manufacturer’s specifications.
- The system’s leak tightness shall be inspected every three months according to the manufacturer’s specifications.
- The external pump exhaust filter shall be exchanged every six months.
- As part of an annual basic maintenance, the carbon vanes of the vacuum pump shall be exchanged once a year. Furthermore, it is recommended to carry out a yearly inspection and, if required, a re-calibration of the radiometric measurement using the foil set.
- The cleaning of the sampling tube shall be paid attention to during the annual basic maintenance.

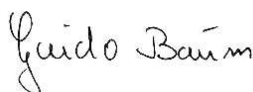
Further details are provided in the user manual.

Department of Environmental Protection/Air Pollution Control



---

Karsten Pletscher



---

Guido Baum

Cologne, 20 September 2013  
936/21209885/H

## 8. Literature

- [1] Standard VDI 4202, Part 1, "Performance criteria for performance tests of automated ambient air measuring systems – Point-related measurement methods for gaseous and particulate air pollutants", June 2002 & September 2010
- [2] Standard VDI 4203, Part 3, "Testing of automated measuring systems – Test procedures for point-related ambient air measuring systems for gaseous and particulate air pollutants", August 2004 & September 2010
- [3] Standard EN 14907, "Ambient air quality – Standard gravimetric measurement method for the determination of the PM<sub>2.5</sub> mass fraction of suspended particulate matter", German version EN 14907: 2005
- [4] Guide "Demonstration of Equivalence of Ambient Air Monitoring Methods", English version of January 2010
- [5] Operating manual Modell 5014i Beta, 12 March 2013
- [6] Operating manual LVS3, Stand 2000
- [7] Directive 2008/50/EC of the European Parliament and of the Council of 21 May 2008 on ambient air quality and cleaner air for Europe
- [8] Report "UK Equivalence Programme for Monitoring of Particulate Matter", Report No.: BV/AQ/AD202209/DH/2396 of 5 June 2006[9] Technical specification CEN/TS 16450, "Ambient air – Automated measuring systems for the measurement of the concentration of particulate matter (PM10; PM2.5)", English Version of May 2013

## **9. Appendix**

### **Appendix 1 Measured and calculated values**

- Annex 1: Detection limit
- Annex 2: Temperature dependence of zero point
- Annex 3: Temperature dependence of the sensitivity
- Annex 4: Dependence on supply voltage
- Annex 5: Measured values at the field test sites
- Annex 6: Ambient conditions at the field test sites
- Annex 7: Measured values from the additional campaign Bornheim, summer 2013
- Annex 8: Ambient conditions during the additional campaign Bornheim, summer 2013

### **Appendix 2 Filter weighing procedure**

### **Appendix 3 Manuals**

Report on the suitability test of the ambient air quality measuring system  
Model 5014i Beta with PM<sub>2.5</sub> pre-separator of the company Thermo Fisher  
Scientific for the component suspended particulate matter PM<sub>2.5</sub>,  
Report No.: 936/21209885/H



## Deutsche Akkreditierungsstelle GmbH

Beliehene gemäß § 8 Absatz 1 AkkStelleG i.V.m. § 1 Absatz 1 AkkStelleGBV  
Unterzeichnerin der Multilateralen Abkommen  
von EA, ILAC und IAF zur gegenseitigen Anerkennung

## Akkreditierung



Die Deutsche Akkreditierungsstelle GmbH bestätigt hiermit, dass das Prüflaboratorium

### **TÜV Rheinland Energie und Umwelt GmbH**

mit seiner

#### **Messstelle für Immissionsschutz (Environmental Protection)**

**Am Grauen Stein, 51105 Köln**

und seiner unselbständigen Messstelle

**Robert-Koch-Straße 27, 55129 Mainz**

die Kompetenz nach DIN EN ISO/IEC 17025:2005 und CEN/TS 15675:2007 besitzt,  
Prüfungen in folgenden Bereichen durchzuführen:

Bestimmung (Probenahme und Analytik) von anorganischen und organischen gas- oder partikelförmigen Luftinhaltsstoffen im Rahmen von Emissions- und Immissionsmessungen; Probenahme von luftgetragenen polyhalogenierten Dibenz-p-Dioxinen und Dibenzofuranen bei Emissionen und Immissionen; Probenahme von faserförmigen Partikeln bei Emissionen und Immissionen; Ermittlung von gas- oder partikelförmigen Luftinhaltsstoffen mit kontinuierlich arbeitenden Messgeräten; Bestimmung von Geruchsstoffen in Luft; Kalibrierungen und Funktionsprüfungen kontinuierlich arbeitender Messgeräte für Luftinhaltsstoffe einschließlich Systemen zur Datenauswertung und Emissionsfernüberwachung; Eignungsprüfungen von automatisch arbeitenden Emissions- und Immissionsmessenrichtungen einschließlich Systemen zur Datenauswertung und Emissionsfernüberwachung; Feuerraummessungen; Ermittlung der Emissionen und Immissionen von Geräuschen; Ermittlung von Geräuschen und Vibrationen am Arbeitsplatz; Akustische und schwingungstechnische Messungen im Eisenbahnwesen; Bestimmung von Schalleistungspegeln von zur Verwendung im Freien vorgesehenen Geräten und Maschinen nach Richtlinie 2000/14/EG und Konformitätsbewertungsverfahren; Schallmessungen an Windenergieanlagen (Geräuschemission, Geräuschimmission); Immissionsprognose auf der Grundlage der Technischen Anleitung zur Reinhaltung der Luft und der Geruchsimmisions-Richtlinie und der VDI 3783 Blatt 13;  
Modul Immissionsschutz

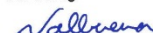
Die Akkreditierungsurkunde gilt nur in Verbindung mit dem Bescheid vom 23.01.2013 mit der Akkreditierungsnummer D-PL-11120-02 und ist gültig bis 22.01.2018. Sie besteht aus diesem Deckblatt, der Rückseite des Deckblatts und der folgenden Anlage mit insgesamt 33 Seiten.

Registrierungsnummer der Urkunde: **D-PL-11120-02-00**

Berlin, 23.01.2013

Siehe Hinweise auf der Rückseite

Im Auftrag



Andrea Valbuena  
Abteilungsleiterin



## Deutsche Akkreditierungsstelle GmbH

Standort Berlin  
Spittelmarkt 10  
10117 Berlin

Standort Frankfurt am Main  
Gartenstraße 6  
60594 Frankfurt am Main

Standort Braunschweig  
Bundesallee 100  
38116 Braunschweig

Die auszugsweise Veröffentlichung der Akkreditierungsurkunde bedarf der vorherigen schriftlichen Zustimmung der Deutsche Akkreditierungsstelle GmbH (DAkKS). Ausgenommen davon ist die separate Weiterverbreitung des Deckblattes durch die umseitig genannte Konformitätsbewertungsstelle in unveränderter Form.

Es darf nicht der Anschein erweckt werden, dass sich die Akkreditierung auch auf Bereiche erstreckt, die über den durch die DAkKS bestätigten Akkreditierungsbereich hinausgehen.

Die Akkreditierung erfolgte gemäß des Gesetzes über die Akkreditierungsstelle (AkkStelleG) vom 31. Juli 2009 (BGBl. I S. 2625) sowie der Verordnung (EG) Nr. 765/2008 des Europäischen Parlaments und des Rates vom 9. Juli 2008 über die Vorschriften für die Akkreditierung und Marktüberwachung im Zusammenhang mit der Vermarktung von Produkten (Abl. L 218 vom 9. Juli 2008, S. 30).

Die DAkKS ist Unterzeichnerin der Multilateralen Abkommen zur gegenseitigen Anerkennung der European co-operation for Accreditation (EA), des International Accreditation Forum (IAF) und der International Laboratory Accreditation Cooperation (ILAC). Die Unterzeichner dieser Abkommen erkennen ihre Akkreditierungen gegenseitig an.

Der aktuelle Stand der Mitgliedschaft kann folgenden Webseiten entnommen werden:

EA: [www.european-accreditation.org](http://www.european-accreditation.org)

ILAC: [www.ilac.org](http://www.ilac.org)

IAF: [www.iaf.nu](http://www.iaf.nu)

**Annex 1**

**Detection limit**

<b>Manufacturer</b> Thermo Fisher Scientific				
<b>Type</b> Model 5014i		<b>Standards</b> ZP Zero filter		
<b>Serial-No.</b> SN 1 / SN 2				
No.	Date	Measured values [µg/m³] SN 1	Date	Measured values [µg/m³] SN 2
1	11/13/2012	1.4	11/13/2012	1.6
2	11/14/2012	1.5	11/14/2012	2.8
3	11/15/2012	1.1	11/15/2012	3.7
4	11/16/2012	0.9	11/16/2012	0.9
5	11/17/2012	1.4	11/17/2012	3.4
6	11/18/2012	3.2	11/18/2012	1.1
7	11/19/2012	3.4	11/19/2012	3.3
8	11/20/2012	2.5	11/20/2012	3.5
9	11/21/2012	1.7	11/21/2012	3.1
10	11/22/2012	1.9	11/22/2012	1.6
11	11/23/2012	2.6	11/23/2012	4.5
12	11/24/2012	1.0	11/24/2012	2.3
13	11/25/2012	1.4	11/25/2012	2.6
14	11/26/2012	2.3	11/26/2012	3.1
15	11/27/2012	2.8	11/27/2012	3.5
No. of values		15	No. of values	
Mean		1.94	Mean	
Standard deviation s <sub>x0</sub>		0.82	Standard deviation s <sub>x0</sub>	
Detection limit x		1.77	Detection limit x	

$$s_{x_0} = \sqrt{\left(\frac{1}{n-1}\right) \cdot \sum_{i=1, n} (x_{0i} - \bar{x}_0)^2}$$

Report on the suitability test of the ambient air quality measuring system Model 5014i Beta with PM<sub>2.5</sub> pre-separator of the company Thermo Fisher Scientific for the component suspended particulate matter PM<sub>2.5</sub>,  
Report-No.: 936/21209885/H

**Annex 2**

**Dependence of zero point on ambient temperature**

<b>Manufacturer</b> Thermo Fisher Scientific										
<b>Type</b> Model 5014i										
<b>Serial-No.</b> SN 1 / SN 2										
			<b>Standards</b>				ZP		Zero filter	
		Cycle 1			Cycle 2			Cycle 3		
SN 1	No.	Temperature [°C]	Measured value [µg/m³]	Dev. [µg/m³]	Measured value [µg/m³]	Dev. [µg/m³]	Measured value [µg/m³]	Dev. [µg/m³]		
ZP	1	20	1.9	-	2.6	-	0.0	-		
	2	5	0.3	-1.6	▶	-0.3	-2.8	▶	1.7	
	3	20	2.0	0.1	▶	2.6	0.1	▶	2.0	
	4	40	2.1	0.2	▶	2.7	0.1	▶	2.7	
	5	20	1.3	-0.6	▶	1.7	-0.9	▶	1.1	
SN 2	No.	Temperature [°C]	Measured value [µg/m³]	Dev. [µg/m³]	Measured value [µg/m³]	Dev. [µg/m³]	Measured value [µg/m³]	Dev. [µg/m³]		
ZP	1	20	3.7	-	4.8	-	2.3	-		
	2	5	-1.5	-5.2	▶	2.8	-2.0	▶	3.3	1.0
	3	20	4.4	0.7	▶	3.9	-0.9	▶	3.3	1.0
	4	40	3.3	-0.4	▶	2.2	-2.6	▶	2.5	0.2
	5	20	-0.9	-4.6	▶	3.0	-1.8	▶	1.5	-0.8



Report on the suitability test of the ambient air quality measuring system Model 5014i Beta with PM<sub>2.5</sub> pre-separator of the company Thermo Fisher Scientific for the component suspended particulate matter PM<sub>2.5</sub>,  
Report-No.: 936/21209885/H

**Annex 4**

**Dependence of measured value on mains voltage**

<b>Manufacturer</b> Thermo Fisher Scientific										
<b>Type</b> Model 5014i										
<b>Serial-No.</b> SN 1 / SN 2										
			<b>Standards</b>				ZP		Reference foils	
		Cycle 1		Cycle 2		Cycle 3				
SN 1	No.	Mains voltage [V]	Measured value	Dev. [%]	Measured value	Dev. [%]	Measured value	Dev. [%]		
RP	1	230	7193.2	-	7073.2	-	7145.8	-		
	2	190	7140.8	-0.7	7112.4	0.6	7117.6	-0.4		
	3	230	7118.4	-1.0	7159.4	1.2	7188.8	0.6		
	4	245	7259.1	0.9	6976.9	-1.4	6976.9	-2.4		
	5	230	7046.9	-2.0	7158.2	1.2	7127.1	-0.3		
SN 2	No.	Mains voltage [V]	Measured value	Dev. [%]	Measured value	Dev. [%]	Measured value	Dev. [%]		
RP	1	230	7112.4	-	7135.7	-	7183.2	-		
	2	190	7144.7	0.5	7094.3	-0.6	7051.4	-1.8		
	3	230	7033.4	-1.1	7131.4	-0.1	6978.4	-2.9		
	4	245	7154.2	0.6	7012.4	-1.7	7063.6	-1.7		
	5	230	7047.2	-0.9	7095.2	-0.6	6985.7	-2.7		

Report on the suitability test of the ambient air quality measuring system Model 5014i Beta with PM<sub>2.5</sub> pre-separator of the company Thermo Fisher Scientific for the component suspended particulate matter PM<sub>2.5</sub>,  
Report-No.: 936/21209885/H

**Annex 5**

**Measured values from field test sites, related to actual conditions**

**Page 1 of 11**

Manufacturer		Thermo Fisher Scientific							PM2,5		
Type of instrument		Model 5014i BETA							Measured values in µg/m³ (ACT)		
Serial-No.		SN 1 / SN 2									
No.	Date	Ref. 1 PM2,5 [µg/m³]	Ref. 2 PM2,5 [µg/m³]	Ref. 1 PM10 [µg/m³]	Ref. 2 PM10 [µg/m³]	Ratio PM2,5/PM10 [%]	SN 1 PM2,5 [µg/m³]	SN 2 PM2,5 [µg/m³]	Remark	Test site	
1	3/8/2011	31.1	31.8	43.9	43.8	71.7	30.7	31.0		Cologne, Winter	
2	3/9/2011	19.1	18.8	30.5	28.7	63.9	21.3	20.9			
3	3/10/2011								Complete power loss		
4	3/11/2011	16.7	16.1	33.5	33.1	49.2			Recovery after re-start		
5	3/12/2011						18.3	19.4			
6	3/13/2011	13.3	13.1	16.2	15.6	83.0	14.9	11.4			
7	3/14/2011	18.2	20.0	27.7	25.6	71.5			Power loss, only Thermo		
8	3/15/2011	37.4	37.8	44.1	43.1	86.3			Recovery after re-start		
9	3/16/2011	55.0	57.8	67.3	65.8	84.8	56.9	59.0			
10	3/17/2011	50.7	49.6	68.0	67.1	74.1	58.9	55.0			
11	3/18/2011	28.4	28.1	38.4	38.4	73.5	31.8	30.7			
12	3/19/2011						12.7	13.6			
13	3/20/2011	20.4	20.3	28.6	28.0	72.0	21.6	22.0			
14	3/21/2011	22.4	22.3	34.7	34.3	64.8	25.3	25.4			
15	3/22/2011	41.7	41.6	55.7	54.8	75.4	46.6	43.9			
16	3/23/2011	20.3	20.4	33.1	31.6	63.0	22.4	21.4			
17	3/24/2011	18.6	20.2	33.3	32.7	58.7	20.9	19.5			
18	3/25/2011	27.6	27.5	36.9	37.2	74.2	29.1	28.9			
19	3/26/2011						13.1	14.7			
20	3/27/2011	24.6	24.8	35.6	35.4	69.5	25.7	25.7			
21	3/28/2011	20.5	20.7	32.4	31.9	64.2	21.7	21.3			
22	3/29/2011	44.7	44.2	65.4	65.6	67.8	47.0	48.2			
23	3/30/2011	15.6	15.6	24.0	23.4	65.8	15.3	19.6			
24	3/31/2011	6.0	5.1	10.5	9.3	56.2	8.0	8.1			
25	4/1/2011	8.5	7.7	13.3	13.0	61.7	8.0	8.2			
26	4/2/2011						16.8	18.7			
27	4/3/2011	14.6	13.7	22.1	22.4	63.6	13.4	12.6			
28	4/4/2011	8.8	9.0	17.9	16.6	51.6	9.5	12.2			
29	4/5/2011	11.0	11.4	19.2	19.0	58.7	8.3	9.9			
30	4/6/2011	13.0	12.9	23.6	23.8	54.6	14.8	14.0			

Report on the suitability test of the ambient air quality measuring system Model 5014i Beta with PM<sub>2.5</sub> pre-separator of the company Thermo Fisher Scientific for the component suspended particulate matter PM<sub>2.5</sub>,  
Report-No.: 936/21209885/H

**Annex 5**

**Measured values from field test sites, related to actual conditions**

Manufacturer		Thermo Fisher Scientific							PM2,5	
Type of instrument		Model 5014i BETA							Measured values in µg/m <sup>3</sup> (ACT)	
Serial-No.		SN 1 / SN 2								
No.	Date	Ref. 1 PM2,5 [µg/m <sup>3</sup> ]	Ref. 2 PM2,5 [µg/m <sup>3</sup> ]	Ref. 1 PM10 [µg/m <sup>3</sup> ]	Ref. 2 PM10 [µg/m <sup>3</sup> ]	Ratio PM2,5/PM10 [%]	SN 1 PM2,5 [µg/m <sup>3</sup> ]	SN 2 PM2,5 [µg/m <sup>3</sup> ]	Remark	Test site
31	4/7/2011	13.7	13.1	23.2	24.2	56.7	13.3	14.2	Cologne, Winter	
32	4/8/2011	19.0	19.8	34.9	34.8	55.7				
33	4/9/2011									
34	4/10/2011	11.1	11.8	23.4	22.3	50.1				
35	4/11/2011	15.2	15.1	31.3	31.5	48.2	14.4	13.6		
36	4/12/2011	9.0	8.2	18.0	17.1	49.0	9.6	10.0		
37	4/13/2011	12.5	12.2	24.4	23.2	51.9	14.2	14.8		
38	4/14/2011	19.6	19.4	32.0	31.5	61.5	22.4	22.8		
39	4/15/2011	13.3	11.4	31.9	31.9	38.8	13.9	15.4		
40	4/16/2011						21.4	22.2		
41	4/17/2011						15.2	15.4		
42	4/18/2011	17.0	17.2	26.4	26.6	64.6	21.0	22.4		
43	4/19/2011	17.5	17.9	30.3	30.7	58.0	23.1	23.1		
44	4/20/2011	20.0	20.8	33.9	34.2	59.8	24.9	26.2		
45	4/21/2011						23.4	24.3		
46	4/22/2011						19.4	18.0		
47	4/23/2011						33.1	33.1		
48	4/24/2011						26.5	25.3		
49	4/25/2011	19.6	20.7	27.4	27.4	73.6	21.9	20.7		
50	4/26/2011	17.0	17.6	31.0	31.3	55.7		20.1		
51	4/27/2011			44.3	45.1			25.1		
52	4/28/2011	16.2	17.8	28.0	28.0	60.8	21.3	24.5		
53	4/29/2011	19.0	19.3	25.9	27.3	72.0	22.8	22.6		
54	4/30/2011	12.9	13.3	21.0	22.0	61.0	16.5	15.5		
55	5/1/2011	6.7	7.0	13.0	12.9	52.9	6.8	8.5		
56	5/2/2011	9.3	9.2	16.1	14.9	59.8	10.8	11.5		
57	5/3/2011	9.0	9.3	15.9	15.1	59.2		12.3		
58	5/4/2011	11.4	11.5	20.5	20.2	56.1	14.0	14.0		
59	5/5/2011			20.1	19.5		14.6	13.2		
60	5/6/2011	13.7	13.6	30.7	31.1	44.2	16.1	17.8		

**Annex 5**

**Measured values from field test sites, related to actual conditions**

Manufacturer Thermo Fisher Scientific Type of instrument Model 5014i BETA Serial-No. SN 1 / SN 2										
PM <sub>2.5</sub> Measured values in µg/m <sup>3</sup> (ACT)										
No.	Date	Ref. 1 PM <sub>2.5</sub> [µg/m <sup>3</sup> ]	Ref. 2 PM <sub>2.5</sub> [µg/m <sup>3</sup> ]	Ref. 1 PM <sub>10</sub> [µg/m <sup>3</sup> ]	Ref. 2 PM <sub>10</sub> [µg/m <sup>3</sup> ]	Ratio PM <sub>2.5</sub> /PM <sub>10</sub> [%]	SN 1 PM <sub>2.5</sub> [µg/m <sup>3</sup> ]	SN 2 PM <sub>2.5</sub> [µg/m <sup>3</sup> ]	Remark	Test site
61	5/7/2011	19.1	17.6	46.1	47.5	39.2	21.5	22.2		Cologne, Winter
62	5/8/2011	12.3	12.2	23.4	23.0	53.0	12.8	14.5		
63	7/25/2011	12.1	11.2	17.8	17.8	65.4			Recovery after zero point	Bornheim, Summer
64	7/26/2011	11.8	11.8	19.6	19.1	61.2	15.5	14.4		
65	7/27/2011	14.3	13.7	21.5	20.9	65.9	12.3	15.9		
66	7/28/2011	17.5	19.0	26.5	25.2	70.6	14.6		SN2 NEPH malfunction	
67	7/29/2011	10.2	7.9	16.8	16.6	54.2	9.8		SN2 in repair	
68	7/30/2011						5.5		SN2 in repair	
69	7/31/2011	9.8	9.5	13.3	14.2	70.4	12.0		SN2 in repair	
70	8/1/2011	12.7	11.4	18.0	19.2	64.8	15.5		SN2 in repair	
71	8/2/2011	10.3	10.1	19.0	20.1	52.1	11.3		SN2 in repair	
72	8/3/2011	17.0	16.6	24.4	26.1	66.5	15.1		SN2 in repair	
73	8/4/2011	8.7	8.4	13.8	14.7	60.2	11.4		SN2 in repair	
74	8/5/2011	8.6	10.6	17.1	18.0	54.7	10.7	10.0		
75	8/6/2011						7.8	7.6		
76	8/7/2011	2.8	3.1	5.6	6.4	49.5	1.2	5.0		
77	8/8/2011	2.8	4.0	7.9	7.5	44.1	5.6	5.1		
78	8/9/2011	2.7	3.2	10.8	11.2	27.1	4.7		SN 2 filter tape error	
79	8/10/2011	5.3	6.4	12.1	12.7	47.0	7.2	14.6		
80	8/11/2011	5.5	5.2	11.4	11.1	47.3	4.9	5.7		
81	8/12/2011	3.0	3.8	6.4	7.0	50.2	2.7	3.5		
82	8/13/2011						4.8	5.4		
83	8/14/2011	2.6	3.6	7.0	6.7	45.5	5.4	6.0		
84	8/15/2011	6.0	5.4	13.5	13.9	41.7	7.5	8.0		
85	8/16/2011	6.0	6.0	13.7	12.9	45.1	6.1	8.4		
86	8/17/2011	14.7	14.0	25.8	25.0	56.3	13.0	14.4		
87	8/18/2011	9.0	8.7	16.8	15.9	54.1	10.4	9.6		
88	8/19/2011	6.6	6.2	13.3	12.8	48.8	10.2	10.2		
89	8/20/2011						9.9	9.4		
90	8/21/2011	10.4	10.3	17.1	17.2	60.4	12.9	12.5		



Report on the suitability test of the ambient air quality measuring system Model 5014i Beta with PM<sub>2.5</sub> pre-separator of the company Thermo Fisher Scientific for the component suspended particulate matter PM<sub>2.5</sub>,  
Report-No.: 936/21209885/H

**Annex 5**

**Measured values from field test sites, related to actual conditions**

Manufacturer Thermo Fisher Scientific Type of instrument Model 5014i BETA Serial-No. SN 1 / SN 2										
PM <sub>2.5</sub> Measured values in µg/m <sup>3</sup> (ACT)										
No.	Date	Ref. 1 PM <sub>2.5</sub> [µg/m <sup>3</sup> ]	Ref. 2 PM <sub>2.5</sub> [µg/m <sup>3</sup> ]	Ref. 1 PM <sub>10</sub> [µg/m <sup>3</sup> ]	Ref. 2 PM <sub>10</sub> [µg/m <sup>3</sup> ]	Ratio PM <sub>2.5</sub> /PM <sub>10</sub> [%]	SN 1 PM <sub>2.5</sub> [µg/m <sup>3</sup> ]	SN 2 PM <sub>2.5</sub> [µg/m <sup>3</sup> ]	Remark	Test site
91	8/22/2011	10.9	10.8	19.7	19.3	55.8	13.2	11.5		Bornheim, Summer
92	8/23/2011	19.2	19.1	29.9	30.1	63.7	22.5	20.0		
93	8/24/2011	6.7	7.4	16.9	16.7	41.9	6.7	7.3		
94	8/25/2011	11.5	12.1	18.8	18.6	63.4	11.1	8.9		
95	8/26/2011	4.9	5.5	10.7	10.7	48.8	7.9	6.8		
96	8/27/2011						6.4	4.7		
97	8/28/2011			7.7	7.6		3.5	4.1		
98	8/29/2011	5.9	6.2	11.4	11.5	53.0	5.5	4.9		
99	8/30/2011	9.1	8.1	17.1	16.6	51.1	10.3	8.4		
100	8/31/2011	14.5	13.9	26.0	23.6	57.2	12.7	13.1		
101	9/1/2011	17.7	18.2	27.5	26.1	66.9	16.8	16.2		
102	9/2/2011	14.9	15.0	25.1	24.1	60.6	14.4	15.1		
103	9/3/2011						15.3	14.4		
104	9/4/2011	8.2	8.0	12.7	12.1	65.3	5.8	7.2		
105	9/5/2011	4.8	5.0	9.2	9.1	53.8	2.5	3.7		
106	9/6/2011	5.2	5.6	11.1	10.6	49.8	3.5	5.5		
107	9/7/2011	6.1	5.8	12.5	13.2	46.1	4.2	4.6		
108	9/8/2011						3.1	4.2		
109	9/9/2011	6.8	7.1	12.1	11.8	57.9	6.6	6.3		
110	9/10/2011						9.4	9.6		
111	9/11/2011	5.7	5.5	9.4	9.3	59.5	3.7	4.9		
112	9/12/2011	5.2	6.1	11.6	11.6	48.5	3.2	2.9		
113	9/13/2011	6.3	7.2	16.3	16.8	40.6	4.1	6.9		
114	9/14/2011	6.7	7.2	15.3	15.6	44.9	5.3	6.7		
115	9/15/2011	11.1	12.2	24.3	24.9	47.4	11.0	13.3		
116	9/16/2011	13.0	13.7	23.0	25.1	55.4			Inlet -> Zero filter	
117	9/17/2011								Zero point	
118	9/18/2011	3.2	3.9	7.0	7.1	50.4			Zero point	
119	9/19/2011	7.8	8.2	12.5	11.6	66.2			Zero filter -> Inlet	
120	9/20/2011						4.9	7.3		

**Annex 5**

**Measured values from field test sites, related to actual conditions**

Manufacturer Thermo Fisher Scientific Type of instrument Model 5014i BETA Serial-No. SN 1 / SN 2										
PM <sub>2,5</sub> Measured values in µg/m <sup>3</sup> (ACT)										
No.	Date	Ref. 1 PM <sub>2,5</sub> [µg/m <sup>3</sup> ]	Ref. 2 PM <sub>2,5</sub> [µg/m <sup>3</sup> ]	Ref. 1 PM <sub>10</sub> [µg/m <sup>3</sup> ]	Ref. 2 PM <sub>10</sub> [µg/m <sup>3</sup> ]	Ratio PM <sub>2,5</sub> /PM <sub>10</sub> [%]	SN 1 PM <sub>2,5</sub> [µg/m <sup>3</sup> ]	SN 2 PM <sub>2,5</sub> [µg/m <sup>3</sup> ]	Remark	Test site
121	9/21/2011			12.4	12.3		7.3	6.1		Bomheim, Summer
122	9/22/2011	6.4	7.8	19.2	18.9	37.3	10.1	9.5		
123	9/23/2011	12.2	13.4	26.1	26.2	49.1	15.9	15.9		
124	9/24/2011						14.7	14.3		
125	9/25/2011	15.7	14.5	21.3	21.7	70.0	15.6	16.4		
126	9/26/2011			18.8	20.6		15.2	13.5		
127	9/27/2011			38.3	39.8		23.2	21.8		
128	9/28/2011						17.8	18.4		
129	9/29/2011	17.1	16.0				17.7	17.2		
130	9/30/2011	12.4	11.8	23.4	24.5	50.6	15.1	14.1		
131	10/1/2011						14.3	15.1		
132	10/2/2011						23.2	26.0		
133	10/3/2011	13.5	14.8				17.8	18.2		
134	10/4/2011	9.8	9.8	15.9	16.3	60.9	11.9	10.5		
135	10/5/2011	4.5	2.5	7.0	6.5	51.8	4.7	3.2		
136	10/6/2011	5.5	4.1	10.8	10.4	45.6	3.5	3.7		
137	10/7/2011	3.6	3.1	8.1	7.6	42.9	4.5	5.7		
138	10/8/2011						6.0	6.4		
139	10/9/2011	6.0	6.4	10.1	10.4	60.7	2.7	5.0		
140	10/10/2011	4.7	5.2	11.9	12.5	40.9	9.2	5.8		
141	10/11/2011	1.3	2.0	5.5	5.0	31.2	4.0	4.6		
142	10/12/2011	1.9	3.2	5.3	5.0	49.3	6.2	6.7		
143	10/13/2011	4.2	4.2	11.5	11.7	36.3	7.8	8.5		
144	10/14/2011	5.9	8.5	14.8	14.0	50.2	11.9	9.8		
145	10/15/2011						11.4	11.0		
146	10/16/2011	11.1	13.7	17.0	16.7	73.7	16.2	16.7		
147	10/17/2011	18.6	20.1	28.0	27.3	70.0	24.7	18.6		
148	10/18/2011	4.3	6.7	11.6	11.5	47.7	9.6	7.7		
149	10/19/2011	3.8	5.2				7.1	6.9	Outlier ref. PM10	
150	10/20/2011	9.3	9.5	11.9	15.8	67.9	11.8	13.3		

Report on the suitability test of the ambient air quality measuring system Model 5014i Beta with PM<sub>2.5</sub> pre-separator of the company Thermo Fisher Scientific for the component suspended particulate matter PM<sub>2.5</sub>,  
Report-No.: 936/21209885/H

**Annex 5**

**Measured values from field test sites, related to actual conditions**

Manufacturer Thermo Fisher Scientific Type of instrument Model 5014i BETA Serial-No. SN 1 / SN 2										
PM <sub>2.5</sub> Measured values in µg/m <sup>3</sup> (ACT)										
No.	Date	Ref. 1 PM <sub>2.5</sub> [µg/m <sup>3</sup> ]	Ref. 2 PM <sub>2.5</sub> [µg/m <sup>3</sup> ]	Ref. 1 PM <sub>10</sub> [µg/m <sup>3</sup> ]	Ref. 2 PM <sub>10</sub> [µg/m <sup>3</sup> ]	Ratio PM <sub>2.5</sub> /PM <sub>10</sub> [%]	SN 1 PM <sub>2.5</sub> [µg/m <sup>3</sup> ]	SN 2 PM <sub>2.5</sub> [µg/m <sup>3</sup> ]	Remark	Test site
151	10/21/2011	17.6	18.1	28.0	26.4	65.5			Inlet -> Zero filter Zero point / Outlier Ref PM10 Zero point Zero filter -> Inlet	Bornheim, Summer
152	10/22/2011									
153	10/23/2011	23.0	23.2							
154	10/24/2011	15.4	15.4							
155	10/25/2011	11.0	12.1				13.6	15.0		
156	10/26/2011	6.0	6.7				10.2	8.0		
157	10/27/2011	18.1	19.3				19.8	17.7		
158	10/28/2011	17.8	18.0	27.2	27.3	65.6	18.5	19.1		
159	10/29/2011						18.8	17.3		
160	10/30/2011	11.7	12.2	16.8	16.3	72.0	13.0	12.7		
161	10/31/2011						21.4	19.1		
162	11/1/2011	22.5	22.3	30.8	28.4	75.7	18.7	19.6		
163	11/2/2011	17.2	17.3				16.3	14.9		
164	11/3/2011	9.2	10.8	17.8	17.5	56.4	13.1	12.8		
165	11/4/2011	13.7	14.3	21.0	21.1	66.5	15.8	15.0		
166	11/5/2011						24.2	24.0		
167	11/6/2011	55.2	54.7	62.1	63.5	87.5	57.9	48.6		
168	11/7/2011	34.6	34.3	39.5	40.6	85.9	38.3	34.3		
169	11/8/2011	43.7	43.6	53.1	54.2	81.4	47.9	44.1		
170	11/9/2011	24.0	23.4	28.6	29.9	81.1	28.5	23.1		
171	11/10/2011	14.3	13.9	17.3	17.3	81.4	15.5	14.3		
172	11/11/2011	26.9	27.9	35.1	35.3	78.0			Zero point Zero point Zero point	Bornheim, Winter
173	11/12/2011									
174	11/13/2011	21.5	21.5	24.1	24.7	88.1				
175	1/16/2012	20.6	22.3	28.9	28.1	75.1	22.6	26.6		
176	1/17/2012	32.7	33.2	44.3	45.6	73.4	36.8	35.0		
177	1/18/2012	19.5	18.9	28.9	26.4	69.4	21.4	20.6		
178	1/19/2012	3.5	3.5	4.1	5.3	74.2	3.2	6.1		
179	1/20/2012	6.2	5.9	8.6	9.5	67.3	7.3	7.2		
180	1/21/2012						5.9	7.6		

**Annex 5**

**Measured values from field test sites, related to actual conditions**

Manufacturer Thermo Fisher Scientific Type of instrument Model 5014i BETA Serial-No. SN 1 / SN 2										
PM <sub>2,5</sub> Measured values in µg/m <sup>3</sup> (ACT)										
No.	Date	Ref. 1 PM <sub>2,5</sub> [µg/m <sup>3</sup> ]	Ref. 2 PM <sub>2,5</sub> [µg/m <sup>3</sup> ]	Ref. 1 PM <sub>10</sub> [µg/m <sup>3</sup> ]	Ref. 2 PM <sub>10</sub> [µg/m <sup>3</sup> ]	Ratio PM <sub>2,5</sub> /PM <sub>10</sub> [%]	SN 1 PM <sub>2,5</sub> [µg/m <sup>3</sup> ]	SN 2 PM <sub>2,5</sub> [µg/m <sup>3</sup> ]	Remark	Test site
181	1/22/2012	5.4	5.1	11.4	12.9	43.1	7.1	7.9		Bomheim, Winter
182	1/23/2012	7.0	7.9	11.7	13.5	59.0	9.5	9.7		
183	1/24/2012			20.9	21.5		17.0	15.5		
184	1/25/2012	19.9	20.0	28.3	25.5	74.1	20.7	21.0		
185	1/26/2012	22.7	22.3	29.3	27.6	79.0	24.2	23.0		
186	1/27/2012	17.0	16.0	24.1	24.3	68.2	18.0	20.2		
187	1/28/2012						16.4	17.3		
188	1/29/2012	64.0	62.4	69.2	69.8	90.9	69.2	70.1		
189	1/30/2012	61.2	60.2	71.2	71.6	85.0	68.5	70.0		
190	1/31/2012	36.5	36.6	44.2	42.8	84.0	40.9	41.1		
191	2/1/2012	25.3	25.1	31.6	31.4	80.0	27.5	29.3		
192	2/2/2012	20.1	20.2	25.6	25.3	79.2	23.6	22.8		
193	2/3/2012	29.0	28.9	37.6	36.7	77.9	29.6	29.1		
194	2/4/2012						33.8	35.5		
195	2/5/2012	24.1	25.6	31.3	30.1	81.1	28.3	28.1		
196	2/6/2012	31.9	32.4	41.3	40.4	78.7	37.9	37.8		
197	2/7/2012	25.2	25.7	37.6	35.5	69.7	28.4	28.9		
198	2/8/2012	33.4	34.4	43.6	42.7	78.6	36.4	38.9		
199	2/9/2012	30.1	32.6	38.7	37.7	82.0	34.6	35.5		
200	2/10/2012								Inlet -> Zero point Zero point Zero point	
201	2/11/2012									
202	2/12/2012									
203	2/13/2012	39.6	36.0	41.9	41.0	91.1	39.7	39.2		
204	2/14/2012	10.3	9.8	16.6	15.7	62.3	13.7	14.1		
205	2/15/2012	7.1	6.7	14.7	15.0	46.6	9.0	9.3		
206	2/16/2012	15.6	14.2	20.8	21.9	69.7	15.7	13.7		
207	2/17/2012	9.7	9.1	11.3	11.9	80.8	12.1	9.9		
208	2/18/2012						4.7	4.9		
209	2/19/2012						9.5	9.6		
210	2/20/2012	10.3	10.6	16.6	17.6	61.0	11.2	9.5		

Report on the suitability test of the ambient air quality measuring system Model 5014i Beta with PM<sub>2.5</sub> pre-separator of the company Thermo Fisher Scientific for the component suspended particulate matter PM<sub>2.5</sub>,  
Report-No.: 936/21209885/H

**Annex 5**

**Measured values from field test sites, related to actual conditions**

Manufacturer Thermo Fisher Scientific Type of instrument Model 5014i BETA Serial-No. SN 1 / SN 2										
PM <sub>2.5</sub> Measured values in µg/m <sup>3</sup> (ACT)										
No.	Date	Ref. 1 PM <sub>2.5</sub> [µg/m <sup>3</sup> ]	Ref. 2 PM <sub>2.5</sub> [µg/m <sup>3</sup> ]	Ref. 1 PM <sub>10</sub> [µg/m <sup>3</sup> ]	Ref. 2 PM <sub>10</sub> [µg/m <sup>3</sup> ]	Ratio PM <sub>2.5</sub> /PM <sub>10</sub> [%]	SN 1 PM <sub>2.5</sub> [µg/m <sup>3</sup> ]	SN 2 PM <sub>2.5</sub> [µg/m <sup>3</sup> ]	Remark	Test site
211	2/21/2012	9.9	10.5	16.3	17.4	60.4	11.5	11.7		Bornheim, Winter
212	2/22/2012	13.3	14.4	20.8	22.2	64.5	16.1	16.7		
213	2/23/2012	8.3	8.6	9.1	10.2	87.3	9.0	8.7		
214	2/24/2012	12.1	11.6	14.7	14.9	80.1	12.7	9.9		
215	2/25/2012						18.6	17.1		
216	2/26/2012	26.5	26.4	38.6	39.6	67.7	27.6	26.5		
217	2/27/2012	19.6	18.9	26.0	25.6	74.6	21.0	17.3		
218	2/28/2012	18.7	16.0	21.8	21.7	79.8	14.9	16.0		
219	2/29/2012	27.6	26.5	34.3	33.7	79.5	22.2	22.6		
220	3/1/2012	19.6	18.0	29.1	29.8	63.7	19.4	17.9		
221	3/2/2012	15.9	13.3	18.9	18.0	78.8	12.5	12.8		
222	3/3/2012						24.4	21.2		
223	3/4/2012	31.5	30.0	42.8	41.3	73.2	27.2	25.9		
224	3/5/2012	6.1	4.6	8.1	7.1	70.6	6.2	7.4		
225	3/6/2012	15.2	12.8	21.5	20.5	66.7	17.1	16.7		
226	3/7/2012	15.5	14.5	24.8	22.4	63.4	16.9	16.0		
227	7/17/2012	4.2	4.5	8.5	8.9	50.1	4.6	5.4		Teddington, Summer
228	7/18/2012	3.8	4.2	8.9	9.4	44.2	4.4	3.9		
229	7/19/2012	4.6	4.6	9.1	8.9	51.2	4.9	4.9		
230	7/20/2012	5.1	4.9	10.3	10.8	47.7	4.3	7.0		
231	7/21/2012	5.8	6.1	10.9	10.7	55.0	7.2	7.7		
232	7/22/2012	7.1	6.8	10.6	10.6	65.3	8.3	7.1		
233	7/23/2012	8.5	8.8	12.7	12.8	67.8	9.2	10.0		
234	7/24/2012	11.4	11.5	17.7	17.7	64.6	13.4	14.3		
235	7/25/2012	17.8	18.5	26.5	26.6	68.4	17.0	18.6		
236	7/26/2012	21.0	21.4				17.2	18.0		
237	7/27/2012	12.3	11.8	20.0	20.3	59.7	18.0	16.9	Outlier ref. PM10	
238	7/28/2012						4.8	4.0		
239	7/29/2012						5.3	3.7		
240	7/30/2012	5.0	4.8	10.0	9.8	49.2	2.7	4.9		

**Annex 5**

**Measured values from field test sites, related to actual conditions**

Manufacturer Thermo Fisher Scientific Type of instrument Model 5014i BETA Serial-No. SN 1 / SN 2										
PM <sub>2,5</sub> Measured values in µg/m <sup>3</sup> (ACT)										
No.	Date	Ref. 1 PM <sub>2,5</sub> [µg/m <sup>3</sup> ]	Ref. 2 PM <sub>2,5</sub> [µg/m <sup>3</sup> ]	Ref. 1 PM <sub>10</sub> [µg/m <sup>3</sup> ]	Ref. 2 PM <sub>10</sub> [µg/m <sup>3</sup> ]	Ratio PM <sub>2,5</sub> /PM <sub>10</sub> [%]	SN 1 PM <sub>2,5</sub> [µg/m <sup>3</sup> ]	SN 2 PM <sub>2,5</sub> [µg/m <sup>3</sup> ]	Remark	Test site
241	7/31/2012	9.2	9.4	14.9	15.7	60.7	8.5	10.7		Teddington, Summer
242	8/1/2012	5.9	5.9	12.7	12.6	46.7	5.4	5.7		
243	8/2/2012	5.3	5.5	12.6	13.0	42.3	3.3	3.8		
244	8/3/2012			13.2	11.9		4.8	4.6	Outlier Ref. PM <sub>2,5</sub>	
245	8/4/2012	4.8	5.3	10.3	10.6	48.3	4.8	5.1		
246	8/5/2012	4.6	4.8	9.2	9.6	50.4	5.2	5.9		
247	8/6/2012	3.4	3.6	7.7	8.0	44.4	4.4	5.8		
248	8/7/2012	3.5	3.4	7.8	8.0	43.4	2.3	3.1		
249	8/8/2012	8.1	8.1	12.0	12.7	65.7	9.7	11.2	SN1 malfunction	
250	8/9/2012	11.5	11.6	15.9	16.8	70.5	9.7	11.3	SN1 defective	
251	8/10/2012	13.3	13.3	20.2	21.0	64.7	13.6	14.4	SN1 defective	
252	8/11/2012	15.3	15.0	25.6	26.3	58.3	10.4	11.2	SN1 defective	
253	8/12/2012	7.3	7.1	14.4	14.6	49.6	9.3	8.8	SN1 defective	
254	8/13/2012	4.8	4.6	9.0	9.3	51.4		7.7	SN1 defective	
255	8/14/2012	7.7	7.7	13.6	14.1	55.4		5.5	SN1 defective	
256	8/15/2012	7.2	7.1	19.6	19.9	36.2		11.2	SN1 defective	
257	8/16/2012	6.5	6.6	16.0	16.2	40.8	4.9	5.2	SN1 defective	
258	8/17/2012	6.7	6.7	13.7	13.9	48.9		8.3	SN1 defective	
259	8/18/2012	6.9	6.9	10.7	10.9	63.8		6.5	SN1 defective	
260	8/19/2012	6.5	6.4	10.8	11.2	58.4		9.0	SN1 defective	
261	8/20/2012	7.4	7.3	12.4	12.6	58.8		8.7	SN1 defective	
262	8/21/2012			13.8	14.1			5.6	SN1 defective	
263	8/22/2012			14.4	13.8			5.4	SN1 defective	
264	8/23/2012			14.1	14.6			5.9	SN1 defective	
265	8/24/2012			9.7	10.1			3.0	SN1 defective	
266	8/25/2012							3.9	SN1 defective	
267	8/26/2012							4.0	SN1 defective	
268	8/27/2012							4.9	SN1 defective	
269	8/28/2012			14.0	13.6			5.3	SN1 defective	
270	8/29/2012			12.0	12.0			3.7	SN1 defective	

Report on the suitability test of the ambient air quality measuring system Model 5014i Beta with PM<sub>2,5</sub> pre-separator of the company Thermo Fisher Scientific for the component suspended particulate matter PM<sub>2,5</sub>,  
Report-No.: 936/21209885/H

**Annex 5**

**Measured values from field test sites, related to actual conditions**

Manufacturer Thermo Fisher Scientific Type of instrument Model 5014i BETA Serial-No. SN 1 / SN 2										
PM <sub>2,5</sub> Measured values in µg/m <sup>3</sup> (ACT)										
No.	Date	Ref. 1 PM <sub>2,5</sub> [µg/m <sup>3</sup> ]	Ref. 2 PM <sub>2,5</sub> [µg/m <sup>3</sup> ]	Ref. 1 PM <sub>10</sub> [µg/m <sup>3</sup> ]	Ref. 2 PM <sub>10</sub> [µg/m <sup>3</sup> ]	Ratio PM <sub>2,5</sub> /PM <sub>10</sub> [%]	SN 1 PM <sub>2,5</sub> [µg/m <sup>3</sup> ]	SN 2 PM <sub>2,5</sub> [µg/m <sup>3</sup> ]	Remark	Test site
271	8/30/2012			11.5	11.2			7.1	SN 1 defective	Teddington, Summer
272	8/31/2012			13.4	13.3			5.6	SN1 defective	
273	9/1/2012			11.8	11.6			2.5	SN1 defective	
274	9/2/2012			12.6	12.0			10.0	SN1 defective	
275	9/3/2012			14.9	15.0			6.5	SN1 defective	
276	9/4/2012	8.9	8.6	16.8	17.7	50.9		10.8	SN1 defective	
277	9/5/2012	10.7	11.0	21.0	20.8	51.9		5.5	SN1 defective	
278	9/6/2012	11.2	11.4	24.1	24.2	46.7		12.1	Stop PM10 Reference	
279	9/7/2012								Inlet -> Zero filter	
280	9/8/2012								Zero point	
281	9/9/2012								Zero point	
282	9/10/2012								Audits	
283	9/11/2012	4.4	4.4				6.2	4.2		
284	9/12/2012						7.3	7.5		
285	9/13/2012	4.7	4.7				4.3	5.6		
286	9/14/2012	5.1	5.3				8.2	8.2		
287	9/15/2012	8.9	8.6				10.2	7.4		
288	9/16/2012	3.4	3.3				4.4	1.8		
289	9/17/2012	5.9	6.0				7.4	8.5		
290	9/18/2012	6.5	6.3				7.4	6.0		
291	9/19/2012	8.2	8.2				9.2	9.3		
292	9/20/2012	5.4	6.0				7.0	6.1		
293	9/21/2012	5.5	5.2				6.0	7.9		
294	9/22/2012	7.6	7.4				9.0	7.5		
295	9/23/2012	12.4	12.4				9.2	8.5		
296	9/24/2012	3.1	3.2				3.1	3.9		
297	9/25/2012	2.5	2.6				3.0	3.1		
298	9/26/2012	5.6	5.7				6.4	5.4		
299	9/27/2012	4.6	4.5				6.2	7.1		
300	9/28/2012	3.3	3.5				1.2	3.6		

**Annex 5**

**Measured values from field test sites, related to actual conditions**

Manufacturer Thermo Fisher Scientific Type of instrument Model 5014i BETA Serial-No. SN 1 / SN 2										
PM <sub>2,5</sub> Measured values in µg/m <sup>3</sup> (ACT)										
No.	Date	Ref. 1 PM <sub>2,5</sub> [µg/m <sup>3</sup> ]	Ref. 2 PM <sub>2,5</sub> [µg/m <sup>3</sup> ]	Ref. 1 PM <sub>10</sub> [µg/m <sup>3</sup> ]	Ref. 2. PM <sub>10</sub> [µg/m <sup>3</sup> ]	Ratio PM <sub>2,5</sub> /PM <sub>10</sub> [%]	SN 1 PM <sub>2,5</sub> [µg/m <sup>3</sup> ]	SN 2 PM <sub>2,5</sub> [µg/m <sup>3</sup> ]	Remark	Test site
301	9/29/2012	8.3	8.2				9.9	7.0		Teddington, Summer
302	9/30/2012	4.8	4.6				5.8	4.4		
303	10/1/2012	4.0	3.9				2.6	6.8		
304	10/2/2012	3.7	3.7				3.9	1.9		
305	10/3/2012	3.6	3.4				2.6	3.2		
306	10/4/2012	3.5	3.5				2.2	4.6		
307	10/5/2012	3.3	3.3				4.1	5.4		
308	10/6/2012	11.5	11.2				13.2	12.6		
309	10/7/2012	16.7	16.2				19.5	15.8		
310	10/8/2012	15.4	15.4				15.5	16.4		
311	10/9/2012	8.3	8.5				7.6	7.5		
312	10/10/2012	13.8	13.9				12.4	12.5		
313	10/11/2012	6.3	6.4				7.3	6.9		



Report on the suitability test of the ambient air quality measuring system Model 5014i Beta with PM<sub>2.5</sub> pre-separator of the company Thermo Fisher Scientific for the component suspended particulate matter PM<sub>2.5</sub>,  
Report-No.: 936/21209885/H

Annex 6

Ambient conditions at field test sites

No.	Date	Test site	Mean PM <sub>2.5</sub> -conc. [µg/m <sup>3</sup> ]	PM <sub>2.5</sub> volatiles [µg/m <sup>3</sup> ]*	Ratio volatiles / PM <sub>2.5</sub> [%]	Mean ambient temperature [°C]	Max. ambient temperature [°C]	Ambient pressure [hPa]	Rel. humidity [%]	Wind velocity [m/s]	Wind direction [°]	Precipitation [mm]
1	3/8/2011	Cologne, Winter	31.4	6.4	20.5	7.9	14.4	1013	54.0	2.3	147	0.0
2	3/9/2011		18.9	5.2	27.7	7.1	10.6	1010	75.8	3.5	232	0.9
3	3/10/2011					9.2	10.1	1008	68.9	5.3	231	0.0
4	3/11/2011		16.4	3.1	19.0	8.1	11.4	1008	69.5	3.8	197	0.3
5	3/12/2011			3.5		12.1	16.4	998	61.6	3.3	147	0.3
6	3/13/2011		13.2	2.0	15.2	11.2	14.1	1001	77.3	2.0	156	1.5
7	3/14/2011		19.1			9.8	13.8	1010	81.2	0.3	114	0.0
8	3/15/2011		37.6	7.2	19.2	12.3	19.6	1006	66.2	2.2	96	0.0
9	3/16/2011		56.4	9.3	16.6	9.5	16.9	1000	71.9	2.5	126	0.0
10	3/17/2011		50.1	8.8	17.6	5.7	7.2	1009	86.9	4.7	267	0.0
11	3/18/2011		28.2	10.2	36.3	6.0	7.6	1018	89.1	1.1	135	11.1
12	3/19/2011			5.8		5.0	12.1	1027	59.5	1.2	123	0.0
13	3/20/2011		20.4	5.5	27.1	5.3	13.2	1027	57.7	0.9	150	0.0
14	3/21/2011		22.3	5.2	23.3	6.9	16.1	1029	56.5	1.0	166	0.0
15	3/22/2011		41.6	10.7	25.7	9.4	17.2	1031	62.7	1.1	184	0.0
16	3/23/2011		20.4	7.6	37.1	10.7	18.6	1030	66.8	1.2	161	0.0
17	3/24/2011		19.4	7.1	36.7	10.9	18.6	1021	67.2	1.0	174	0.0
18	3/25/2011		27.5	9.4	34.0	11.8	18.0	1010	59.4	1.6	183	0.0
19	3/26/2011			5.0		7.7	11.6	1010	64.8	1.5	105	0.0
20	3/27/2011		24.7	6.6	26.5	9.3	16.3	1006	60.9	1.1	196	0.0
21	3/28/2011		20.6	6.7	32.4	7.2	13.7	1009	60.2	1.9	172	0.0
22	3/29/2011		44.4	13.9	31.4	9.6	18.5	1007	62.1	1.1	168	0.0
23	3/30/2011		15.6	6.9	44.6	12.6	15.9	1008	66.7	2.4	170	0.0
24	3/31/2011		5.5	2.5	44.8	13.8	15.6	1011	78.2	3.7	230	6.5
25	4/1/2011		8.1	3.3	40.7	13.9	18.8	1014	78.1	2.3	175	0.0
26	4/2/2011			4.3		17.6	24.3	1006	62.2	2.6	159	0.0
27	4/3/2011		14.2	4.8	34.0	10.9	15.8	1009	85.3	2.0	251	8.7
28	4/4/2011		8.9	3.3	37.3	10.0	15.0	1017	65.3	2.7	214	0.0
29	4/5/2011		11.2	3.8	34.4	11.8	15.1	1020	71.9	2.1	173	0.9
30	4/6/2011		13.0	4.4	34.0	16.2	23.0	1019	73.9	1.8	196	0.0

\* volatile PM-compounds, determined with parallel operated TEOM-FDMS-systems

Annex 6

Ambient conditions at field test sites

No.	Date	Test site	Mean PM <sub>2.5</sub> -conc. [µg/m <sup>3</sup> ]	PM <sub>2.5</sub> volatiles [µg/m <sup>3</sup> ]*	Ratio volatiles / PM <sub>2.5</sub> [%]	Mean ambient temperature [°C]	Max. ambient temperature [°C]	Ambient pressure [hPa]	Rel. humidity [%]	Wind velocity [m/s]	Wind direction [°]	Precipitation [mm]
31	4/7/2011	Cologne, Winter	13.4	5.5	40.7	13.8	21.6	1019	67.2	3.0	245	0.0
32	4/8/2011		19.4			12.9	18.2	1018	64.7	2.9	255	0.0
34	4/9/2011					11.3	18.9	1018	59.8	1.3	183	0.0
34	4/10/2011		11.4			14.0	23.1	1016	60.2	1.1	191	0.0
35	4/11/2011		15.1			16.0	25.0	1012	58.8	3.9	244	2.7
36	4/12/2011		8.6			2.9	33.9	1018	66.7	4.1	257	0.9
37	4/13/2011		12.3			3.2	26.2	1013	57.1	2.0	203	0.0
38	4/14/2011		19.5			4.4	22.4	1013	65.4	0.6	159	0.0
39	4/15/2011		12.4			3.1	24.7	1014	53.6	1.2	169	0.0
40	4/16/2011					2.2		1017	51.7	0.9	166	0.0
41	4/17/2011					2.5		1017	53.7	1.2	139	0.0
42	4/18/2011		17.1			3.0	17.8	1011	48.6	1.9	149	0.0
43	4/19/2011		17.7			2.8	15.8	1009	52.4	1.2	146	0.0
44	4/20/2011		20.4			2.9	14.2	1008	51.3	1.1	154	0.0
45	4/21/2011					3.0		1006	54.1	0.7	180	0.0
46	4/22/2011					2.6		1003	51.8	1.3	146	8.3
47	4/23/2011					2.5		1005	58.0	0.7	152	0.0
48	4/24/2011					2.3		1011	51.7	1.0	172	0.0
49	4/25/2011		20.2			2.4	12.0	1013	50.3	1.2	153	0.0
50	4/26/2011		17.3			1.9	11.0	1011	51.5	1.8	166	2.1
51	4/27/2011					7.5		1010	90.4	0.7	213	8.9
52	4/28/2011		17.0			5.4	31.5	1005	77.6	0.7	176	0.3
53	4/29/2011		19.2			2.8	14.7	1002	56.8	1.7	112	3.0
54	4/30/2011		13.1			2.5	19.0	1002	47.4	1.7	141	0.0
55	5/1/2011		6.8			2.3	32.9	1002	44.5	1.6	111	0.0
56	5/2/2011		9.3			2.1	23.0	1004	53.3	2.0	116	0.0
57	5/3/2011		9.2			2.2	24.4	1011	49.4	1.0	164	0.0
58	5/4/2011		11.4			2.9	25.2	1016	61.5	1.3	168	0.0
59	5/5/2011					3.8		1015	46.9	2.2	119	0.0
60	5/6/2011		13.6			2.8	20.3	1012	41.1	2.5	110	0.0

\* volatile PM-compounds, determined with parallel operated TEOM-FDMS-systems

Report on the suitability test of the ambient air quality measuring system Model 5014i Beta with PM<sub>2.5</sub> pre-separator of the company Thermo Fisher Scientific for the component suspended particulate matter PM<sub>2.5</sub>,  
Report-No.: 936/21209885/H

Annex 6

Ambient conditions at field test sites

No.	Date	Test site	Mean PM <sub>2.5</sub> -conc. [µg/m³]	PM <sub>2.5</sub> volatiles [µg/m³]*	Ratio volatiles / PM <sub>2.5</sub> [%]	Mean ambient temperature [°C]	Max. ambient temperature [°C]	Ambient pressure [hPa]	Rel. humidity [%]	Wind velocity [m/s]	Wind direction [°]	Precipitation [mm]
61	5/7/2011	Cologne, Winter	18.4	2.5	13.8	21.9	28.3	1011	37.0	3.4	109	0.0
62	5/8/2011		12.3	1.7	13.7	22.1	28.6	1013	34.7	4.1	97	0.0
63	7/25/2011	Bonheim, Summer	11.6			17.2	22.8	1001	73.8	0.8	193	1.2
64	7/26/2011		11.8	2.9	24.1	17.0	20.6	1006	78.4	1.1	259	0.0
65	7/27/2011		14.0	4.2	29.9	17.3	24.3	1010	84.8	0.7	229	51.7
66	7/28/2011		18.2	5.1	27.9	17.7	24.5	1011	85.6	0.6	228	5.9
67	7/29/2011		9.0	3.5	39.0	16.9	20.2	1011	76.2	2.9	299	0.0
68	7/30/2011			1.6		14.5	16.1	1010	80.4	2.3	288	0.0
69	7/31/2011		9.7	1.2	12.6	13.4	16.6	1009	76.2	0.9	244	0.0
70	8/1/2011		12.1	1.7	13.8	19.1	26.1	1008	68.1	0.9	177	0.0
71	8/2/2011		10.2	1.4	13.4	23.2	30.0	1007	60.8	1.5	143	0.0
72	8/3/2011		16.8	2.6	15.8	19.7	24.1	1006	82.9	1.1	195	5.4
73	8/4/2011		8.6	3.2	36.8	22.3	29.2	1005	71.6	0.8	204	3.6
74	8/5/2011		9.6	1.8	18.3	20.6	25.0	1004	75.8	1.1	221	0.6
75	8/6/2011			1.7		19.3	25.4	996	85.0	1.4	171	7.7
76	8/7/2011		3.0	1.3	43.5	17.8	22.4	998	64.0	1.5	209	1.8
77	8/8/2011		3.4	-0.2	-6.8	15.5	18.4	1000	74.7	2.5	219	6.2
78	8/9/2011		3.0	-0.1	-4.8	13.8	17.8	1012	76.8	2.7	265	14.8
79	8/10/2011		5.8	2.3	38.9	18.0	22.4	1013	57.5	1.3	224	0.0
80	8/11/2011		5.3	1.3	25.3	20.9	25.5	1004	53.8	1.2	220	0.3
81	8/12/2011		3.4	1.0	29.7	18.5	21.7	1003	78.9	1.1	228	2.1
82	8/13/2011			2.0		20.1	23.7	1001	77.0	0.7	185	0.0
83	8/14/2011	3.1	0.1	3.8	17.4	19.9	1000	86.2	1.1	219	17.4	
84	8/15/2011	5.7	0.9	15.7	17.9	22.4	1009	71.8	1.2	230	0.0	
85	8/16/2011	6.0	1.6	27.6	19.1	23.9	1010	69.0	0.7	190	0.6	
86	8/17/2011	14.3	3.1	21.6	21.1	27.8	1007	73.8	0.7	206	4.7	
87	8/18/2011	8.8	2.8	31.5	22.5	31.3	1004	76.6	1.2	174	20.9	
88	8/19/2011	6.4	1.8	27.7	16.8	21.2	1011	80.0	1.5	235	3.3	
89	8/20/2011		1.7		20.7	28.1	1011	66.6	0.8	157	0.0	
90	8/21/2011	10.3	1.2	11.9	23.2	31.4	1007	74.8	1.0	184	0.3	

\* volatile PM-compounds, determined with parallel operated TEOM-FDMS-systems

Annex 6

Ambient conditions at field test sites

No.	Date	Test site	Mean PM <sub>2.5</sub> -conc. [µg/m <sup>3</sup> ]	PM <sub>2.5</sub> volatiles [µg/m <sup>3</sup> ]*	Ratio volatiles / PM <sub>2.5</sub> [%]	Mean ambient temperature [°C]	Max. ambient temperature [°C]	Ambient pressure [hPa]	Rel. humidity [%]	Wind velocity [m/s]	Wind direction [°]	Precipitation [mm]
91	8/22/2011	Bornheim, Summer	10.9	3.2	29.2	20.4	24.4	1009	76.5	1.2	253	0.0
92	8/23/2011		19.1	2.9	15.4	22.6	27.8	1005	78.4	0.9	206	0.0
93	8/24/2011		7.1	1.8	25.3	20.1	27.2	1007	76.6	0.7	192	0.6
94	8/25/2011		11.8	3.1	26.0	20.8	27.6	1003	83.4	1.0	176	2.1
95	8/26/2011		5.2	1.7	32.1	19.4	30.2	999	83.7	1.5	195	29.1
96	8/27/2011			0.7		15.3	20.0	1007	77.0	1.1	207	0.3
97	8/28/2011			1.2		15.6	19.7	1009	69.2	1.3	212	0.0
98	8/29/2011		6.1	0.9	15.0	14.5	18.4	1008	66.7	2.0	243	0.0
99	8/30/2011		8.6	1.5	17.3	13.6	18.4	1008	73.6	0.8	236	0.0
100	8/31/2011		14.2	2.9	20.7	14.8	21.4	1007	72.0	0.7	225	0.0
101	9/1/2011		17.9	4.3	23.8	16.4	23.4	1006	71.6	0.6	182	0.0
102	9/2/2011		14.9	2.2	14.5	21.2	29.4	1004	72.2	0.8	160	0.0
103	9/3/2011			2.3		24.5	30.9	1002	67.0	1.3	132	3.6
104	9/4/2011		8.1	1.0	12.3	20.2	27.4	1002	79.5	1.1	223	0.6
105	9/5/2011		4.9	0.4	8.3	16.6	21.4	1009	62.9	1.9	217	0.0
106	9/6/2011		5.4	1.7	32.2	17.4	20.6	1005	66.8	2.6	219	4.8
107	9/7/2011		5.9	1.3	21.4	14.9	18.1	1004	73.1	2.2	246	5.7
108	9/8/2011			1.0		14.7	16.2	1003	84.7	1.1	209	3.3
109	9/9/2011		6.9	1.0	13.9	19.0	21.6	1004	86.9	0.4	167	0.0
110	9/10/2011			1.1		23.8	29.7	1001	73.0	1.5	155	0.0
111	9/11/2011		5.6	1.4	24.9	16.2	22.1	1003	86.0	0.7	165	16.2
112	9/12/2011		5.6	1.0	18.0	19.4	24.6	1004	71.1	1.7	204	0.0
113	9/13/2011		6.7	0.9	12.7	16.7	20.8	1006	67.3	1.6	219	0.0
114	9/14/2011		6.9	1.0	14.8	15.2	19.6	1011	65.1	1.5	224	0.0
115	9/15/2011		11.7	1.5	12.8	14.1	20.4	1013	75.3	0.6	207	0.0
116	9/16/2011		13.3			17.1	21.9	1006	72.6	1.4	145	0.0
117	9/17/2011					16.8	21.4	1001	70.6	1.0	207	3.6
118	9/18/2011		3.5			13.3	16.5	998	76.4	1.0	200	4.5
119	9/19/2011		8.0			13.6	18.1	1008	75.8	1.4	231	0.9
120	9/20/2011			1.1		15.6	18.5	1014	78.0	0.5	196	0.0

\* volatile PM-compounds, determined with parallel operated TEOM-FDMS-systems

Report on the suitability test of the ambient air quality measuring system Model 5014i Beta with PM<sub>2.5</sub> pre-separator of the company Thermo Fisher Scientific for the component suspended particulate matter PM<sub>2.5</sub>,  
Report-No.: 936/21209885/H

Annex 6

Ambient conditions at field test sites

No.	Date	Test site	Mean PM <sub>2.5</sub> -conc. [µg/m³]	PM <sub>2.5</sub> volatiles [µg/m³]*	Ratio volatiles / PM <sub>2.5</sub> [%]	Mean ambient temperature [°C]	Max. ambient temperature [°C]	Ambient pressure [hPa]	Rel. humidity [%]	Wind velocity [m/s]	Wind direction [°]	Precipitation [mm]	
121	9/21/2011	Bonheim, Summer		1.0		16.9	20.5	1011	69.5	0.8	204	0.0	
122	9/22/2011		7.1	1.1	15.1	15.2	18.7	1011	72.2	1.2	231	0.0	
123	9/23/2011		12.8	1.6	12.4								
124	9/24/2011			1.4									
125	9/25/2011		15.1	1.1	7.1								
126	9/26/2011												
127	9/27/2011			3.1									
128	9/28/2011												
129	9/29/2011		16.6	1.7	10.0								
130	9/30/2011		12.1	1.1	8.9	18.4	26.8	1017	68.3	1.2	155	0.0	
131	10/1/2011			1.2		18.1	28.0	1018	70.6	0.5	176	0.0	
132	10/2/2011			3.5		17.8	26.8	1016	75.4	0.3	213	0.0	
134	10/3/2011		14.2	3.4	24.0	18.8	26.5	1013	65.9	0.8	168	0.0	
134	10/4/2011		9.8	1.4	14.1	17.8	20.5	1013	72.4	1.6	214	0.0	
135	10/5/2011		3.5	1.9	53.3	17.5	20.0	1011	70.8	1.2	199	0.0	
136	10/6/2011	4.8	1.1	23.0	13.2	19.3	1001	71.2	2.3	213	0.3		
137	10/7/2011	3.4	0.5	14.1	9.9	13.4	1005	81.6	3.6	272	5.7		
138	10/8/2011		0.8		8.7	11.4	1009	85.5	2.1	258	6.0		
139	10/9/2011	6.2	1.9	30.6	12.2	16.3	1011	84.5	1.4	190	5.4		
140	10/10/2011	5.0	0.7	14.3	17.7	21.3	1009	74.4	3.2	261	0.3		
141	10/11/2011	1.6	0.8	50.2	16.3	18.0	1010	77.4	3.6	251	0.0		
142	10/12/2011	2.5	0.0	-0.7	12.5	15.8	1012	91.1	0.9	226	17.9		
143	10/13/2011	4.2	0.5	11.8	9.9	15.8	1022	76.3	0.6	209	0.0		
144	10/14/2011	7.2	1.7	23.1	8.7	15.9	1024	69.6	1.0	151	0.0		
145	10/15/2011		2.0		7.8	14.8	1020	68.8	1.2	162	0.0		
146	10/16/2011	12.4	2.3	18.4	8.5	14.8	1016	73.8	1.5	157	0.0		
147	10/17/2011	19.4	4.9	25.2	10.5	16.6	1011	78.5	0.8	163	0.0		
148	10/18/2011	5.5	2.2	39.9	9.2	15.0	1003	82.0	1.2	197	3.0		
149	10/19/2011	4.5	0.6	13.6	8.1	14.0	1010	74.4	1.5	225	0.0		
150	10/20/2011	9.4	1.9	20.7	5.6	10.6	1018	79.8	1.0	223	0.0		

\* volatile PM-compounds, determined with parallel operated TEOM-FDMS-systems

Annex 6

Ambient conditions at field test sites

No.	Date	Test site	Mean PM <sub>2.5</sub> -conc. [µg/m <sup>3</sup> ]	PM <sub>2.5</sub> volatiles [µg/m <sup>3</sup> ]*	Ratio volatiles / PM <sub>2.5</sub> [%]	Mean ambient temperature [°C]	Max. ambient temperature [°C]	Ambient pressure [hPa]	Rel. humidity [%]	Wind velocity [m/s]	Wind direction [°]	Precipitation [mm]	
151	10/21/2011	Bornheim, Summer	17.8	4.2	23.6	5.2	11.4	1019	79.3	1.1	154	0.0	
152	10/22/2011		15.4	5.4	35.1	6.8	11.9	1013	69.3	3.9	128	0.0	
153	10/23/2011		23.1	6.1	26.3	7.4	13.6	1007	71.6	2.3	138	0.0	
154	10/24/2011		15.4	4.0	25.7	9.8	12.4	999	67.2	3.8	132	0.0	
155	10/25/2011		11.6	2.0	17.0	10.9	13.0	997	68.8	1.9	132	0.0	
156	10/26/2011		6.3	1.6	24.5	9.4	15.7	1006	74.9	0.9	171	0.0	
157	10/27/2011		18.7	3.5	18.9	10.1	13.4	1008	80.4	2.7	126	0.0	
158	10/28/2011		17.9	3.2	18.0	14.0	20.1	1016	75.8	0.7	149	0.0	
159	10/29/2011			3.1		13.5	17.2	1015	79.8	1.0	132	0.9	
160	10/30/2011		11.9	2.6	22.1	13.5	18.2	1014	86.7	0.4	170	0.0	
161	10/31/2011			4.4		11.9	17.2	1009	87.0	1.0	152	0.3	
162	11/1/2011		22.4	4.8	21.4	12.2	15.6	1007	83.2	2.0	134	1.8	
163	11/2/2011		17.2	5.3	30.5	12.5	14.7	1002	80.8	2.9	124	0.3	
164	11/3/2011		10.0	3.2	32.2	13.7	17.3	995	69.7	3.8	140	0.0	
165	11/4/2011		14.0	2.2	15.4								
166	11/5/2011			1.6									
167	11/8/2011		55.0	6.4	11.6								
168	11/7/2011		34.4	4.8	13.9								
169	11/8/2011		43.7	5.6	12.8								
170	11/9/2011	23.7	5.4	22.8									
171	11/10/2011	14.1	4.5	32.1									
172	11/11/2011	27.4	4.5	16.3									
173	11/12/2011		6.7			7.2	9.4	1024	81.6	4.1	135	0.0	
174	11/13/2011	21.5	6.0	28.0		5.4	10.1	1023	83.7	2.4	131	0.0	
Outage weather station													
175	1/16/2012	Bornheim, Winter	21.4	3.1	14.4	-0.9	3.9	1020	81.8	0.6	138	0.3	
176	1/17/2012		33.0	3.9	11.8	-0.6	4.7	1022	81.5	0.5	123	0.3	
177	1/18/2012		19.2	4.7	24.7	3.1	7.1	1018	84.3	1.5	126	6.6	
178	1/19/2012		3.5	2.6	73.2	7.2	11.9	1006	84.8	4.1	253	12.8	
179	1/20/2012		6.1	2.6	42.0	3.1	5.4	1008	85.5	3.1	239	5.1	
180	1/21/2012			2.3		7.3	10.3	1000	81.9	5.3	261	6.9	

\* volatile PM-compounds, determined with parallel operated TEOM-FDMS-systems

Report on the suitability test of the ambient air quality measuring system Model 5014i Beta with PM<sub>2.5</sub> pre-separator of the company Thermo Fisher Scientific for the component suspended particulate matter PM<sub>2.5</sub>,  
Report-No.: 936/21209885/H

Annex 6

Ambient conditions at field test sites

No.	Date	Test site	Mean PM <sub>2.5</sub> -conc. [µg/m³]	PM <sub>2.5</sub> volatiles [µg/m³]*	Ratio volatiles / PM <sub>2.5</sub> [%]	Mean ambient temperature [°C]	Max. ambient temperature [°C]	Ambient pressure [hPa]	Rel. humidity [%]	Wind velocity [m/s]	Wind direction [°]	Precipitation [mm]
181	1/22/2012	Bornheim, Winter	5.2	0.8	14.5	6.4	9.3	1003	77.0	4.7	271	1.8
182	1/23/2012		7.4	1.3	17.6	4.2	7.1	1008	83.7	3.0	268	3.6
183	1/24/2012			2.7		2.3	5.5	1014	87.4	0.9	188	0.0
184	1/25/2012		19.9	5.0	25.1	2.5	4.2	1012	81.0	3.9	126	0.0
185	1/26/2012		22.5	6.2	27.7	2.6	4.0	1010	78.6	4.1	127	0.6
186	1/27/2012		16.5	4.0	24.5	2.3	7.4	1016	85.6	1.1	124	0.0
187	1/28/2012			3.2		1.6	4.4	1021	81.0	0.9	166	0.3
188	1/29/2012		63.2	6.6	10.4	-0.4	0.3	1020	81.2	1.4	238	0.0
189	1/30/2012		60.7	6.9	11.4	-0.1	0.9	1017	75.8	1.5	110	0.0
190	1/31/2012		36.5	5.8	15.9	-2.7	0.9	1018	62.8	2.0	116	0.0
191	2/1/2012		25.2	5.2	20.7	-5.2	0.7	1023	53.6	2.2	144	0.0
192	2/2/2012		20.2	3.8	18.6	-7.0	-0.8	1026	50.2	1.5	186	0.0
193	2/3/2012		28.9	5.9	20.3	-8.5	-4.0	1031	69.0	1.0	252	0.0
194	2/4/2012			8.2		-8.5	-3.7	1031	69.8	1.0	182	0.0
195	2/5/2012		24.9	4.9	19.8	-7.9	-3.6	1027	57.9	1.7	142	0.0
196	2/6/2012		32.2	4.8	15.0	-8.9	-3.6	1029	57.8	1.1	152	0.0
197	2/7/2012		25.5	4.3	16.8	-7.6	-4.3	1031	61.6	1.8	148	0.0
198	2/8/2012		33.9	5.4	15.8	-5.7	0.0	1030	68.4	0.8	187	0.0
199	2/9/2012		31.3	6.7	21.4	-5.4	-2.2	1030	81.1	1.6	259	0.0
200	2/10/2012					-5.7	-0.3	1031	64.9	1.1	116	0.6
201	2/11/2012					-7.6	-2.1	1028	67.2	1.1	198	0.0
202	2/12/2012					-4.2	-1.5	1024	69.3	0.9	233	0.0
203	2/13/2012		37.8	8.7	23.1	0.4	1.9	1012	89.7	0.7	208	2.1
204	2/14/2012		10.1			3.1	5.0	1006	88.5	4.4	280	4.2
205	2/15/2012		6.9			3.5	5.3	1008	81.1	5.7	303	0.6
206	2/16/2012		14.9			4.2	5.3	1016	90.4	1.2	246	2.1
207	2/17/2012		9.4			5.6	7.1	1013	87.7	1.7	229	1.2
208	2/18/2012			1.9		6.5	9.4	1005	81.8	2.5	213	1.5
209	2/19/2012			0.4		1.5	4.8	1017	84.7	2.9	270	0.9
210	2/20/2012		10.5	2.3	21.5	1.0	5.1	1026	76.4	0.8	179	0.0

\* volatile PM-compounds, determined with parallel operated TEOM-FDMS-systems

Annex 6

Ambient conditions at field test sites

No.	Date	Test site	Mean PM <sub>2.5</sub> -conc. [µg/m <sup>3</sup> ]	PM <sub>2.5</sub> volatiles [µg/m <sup>3</sup> ]*	Ratio volatiles / PM <sub>2.5</sub> [%]	Mean ambient temperature [°C]	Max. ambient temperature [°C]	Ambient pressure [hPa]	Rel. humidity [%]	Wind velocity [m/s]	Wind direction [°]	Precipitation [mm]
211	2/21/2012	Bornheim, Winter	10.2	1.3	13.1	4.4	8.5	1023	70.8	1.8	176	0.0
212	2/22/2012		13.9			6.3	11.2	1017	69.6	1.6	156	3.0
213	2/23/2012		8.4	2.4	29.0	8.2	10.3	1016	86.2	1.0	191	0.0
214	2/24/2012		11.9	3.6	30.5	9.9	13.7	1017	86.4	2.8	256	1.2
215	2/25/2012			6.3		7.0	10.9	1016	78.1	3.4	269	0.3
216	2/26/2012		26.5	6.4	24.2	5.2	6.9	1019	87.2	1.9	244	0.6
217	2/27/2012		19.2	5.9	30.9	7.7	10.3	1016	77.4	1.1	211	0.6
218	2/28/2012		17.4	5.1	29.3	9.4	10.7	1016	86.5	1.8	252	0.0
219	2/29/2012		27.0	7.0	26.0	10.4	13.3	1017	87.9	0.6	142	0.0
220	3/1/2012		18.8	4.6	24.7	8.8	10.6	1018	90.5	0.8	178	0.0
221	3/2/2012		14.6	4.6	31.6	9.0	11.8	1016	87.0	2.2	151	0.0
222	3/3/2012			6.0		8.7	10.9	1015	82.3	1.2	161	0.3
223	3/4/2012		30.8	9.7	31.4	8.6	11.5	1008	84.6	2.6	129	10.2
224	3/5/2012		5.4	3.6	67.6	5.6	7.8	1010	70.7	4.6	162	0.0
225	3/6/2012		14.0	3.8	27.3	4.8	10.3	1018	72.5	1.6	173	0.0
226	3/7/2012	15.0	5.4	36.4	5.2	7.8	1011	76.5	3.8	218	9.8	
227	7/17/2012	Teddington, Summer	4.3	3	69.0	19.2	25.2	1001	76.1	0.3	213	0.5
228	7/18/2012		4.0	2.0	50.6	16.4	19.6	991	83.8	0.4	212	1.3
229	7/19/2012		4.6	1.6	34.3	16.4	21.2	994	71.7	0.2	270	0.0
230	7/20/2012		5.0	0.8	14.9	16.2	20.0	1001	69.7	0.7	221	0.3
231	7/21/2012		6.0	1.3	22.4	16.9	22.8	1007	64.9	0.3	189	0.0
232	7/22/2012		6.9	1.5	21.0	18.6	23.8	1007	61.9	0.6	203	0.0
234	7/23/2012		8.6	2.0	22.7	21.4	29.4	1002	57.0	0.4	197	0.0
234	7/24/2012		11.4	2.0	17.8	22.8	30.8	997	56.3	0.3	213	0.0
235	7/25/2012		18.1	2.9	16.1	24.2	32.3	998	47.1	1.0	117	0.0
236	7/26/2012		21.2	4.6	21.8	21.8	28.3	996	62.0	1.1	125	0.0
237	7/27/2012		12.0	5.4	44.7	19.9	25.1	992	60.4	0.9	256	0.0
238	7/28/2012			1.8		17.1	23.8	992	55.5	0.3	236	0.0
239	7/29/2012			1.3		13.6	19.9	995	78.7	0.2	198	6.1
240	7/30/2012		4.9	1.2	23.9	16.3	22.0	997	66.3	0.3	195	4.3

\* volatile PM-compounds, determined with parallel operated TEOM-FDMS-systems



Report on the suitability test of the ambient air quality measuring system Model 5014i Beta with PM<sub>2.5</sub> pre-separator of the company Thermo Fisher Scientific for the component suspended particulate matter PM<sub>2.5</sub>,  
Report-No.: 936/21209885/H

Annex 6

Ambient conditions at field test sites

No.	Date	Test site	Mean PM2.5-conc. [µg/m³]	PM2.5 volatiles [µg/m³]*	Ratio volatiles / PM2.5 [%]	Mean ambient temperature [°C]	Max. ambient temperature [°C]	Ambient pressure [hPa]	Rel. humidity [%]	Wind velocity [m/s]	Wind direction [°]	Precipitation [mm]
241	7/31/2012	Teddington, Summer	9.3	2.3	25.0	17.2	21.0	994	84.5	0.4	170	0.5
242	8/1/2012		5.9	2.0	33.9	18.4	23.3	989	75.5	0.7	185	0.0
243	8/2/2012		5.4	1.5	28.4	17.7	22.6	993	73.1	0.8	195	0.0
244	8/3/2012			1.7		17.8	22.7	993	71.6	0.8	180	2.3
245	8/4/2012		5.1	2.3	46.1	16.4	21.0	990	80.7	0.6	200	1.8
246	8/5/2012		4.7	2.2	45.7	17.3	22.4	988	77.6	0.4	210	2.3
247	8/6/2012		3.5	0.5	15.5	16.0	23.3	995	77.5	0.2	190	0.8
248	8/7/2012		3.4	1.5	44.9	17.2	21.1	1003	80.7	0.3	201	0.8
249	8/8/2012		8.1	2.3	28.8	19.0	25.5	1005	73.0	0.2	263	0.0
250	8/9/2012		11.5	2.7	23.5	21.0	28.3	1007	62.7	0.4	202	0.0
251	8/10/2012		13.3	4.4	32.8	21.4	29.4	1005	59.5	0.5	142	0.0
252	8/11/2012		15.1	5.0	33.4	19.8	24.4	997	63.9	1.9	78	0.0
253	8/12/2012		7.2	3.2	44.6	19.8	26.1	992	70.6	0.8	171	0.0
254	8/13/2012		4.7	2.5	53.9	19.2	23.2	992	81.2	0.7	184	1.5
255	8/14/2012		7.7	3.0	38.6	21.1	26.1	991	66.3	0.9	139	0.0
256	8/15/2012		7.1	2.1	29.8	19.0	23.3	989	71.8	1.0	187	0.5
257	8/16/2012		6.6	2.0	31.1	19.8	22.9	996	65.3	1.1	160	0.0
258	8/17/2012		6.7	2.2	32.2	23.4	28.3	993	55.8	0.8	180	0.0
259	8/18/2012		6.9	2.4	34.5	24.2	32.2	995	67.6	0.2	214	0.0
260	8/19/2012		6.4	2.3	35.7	22.7	30.8	997	68.7	0.4	208	0.0
261	8/20/2012		7.4	2.8	37.4	19.7	27.8	1001	77.3	0.2	215	0.0
262	8/21/2012			3.0		17.7	23.3	998	76.0	0.1	207	0.3
263	8/22/2012			2.0		17.6	23.9	998	69.3	0.2	210	0.0
264	8/23/2012			2.3		17.4	22.7	992	69.0	0.2	190	0.0
265	8/24/2012			2.6		17.1	20.6	983	81.7	0.8	174	2.8
266	8/25/2012			1.9		16.7	22.5	987	81.9	0.5	243	27.9
267	8/26/2012			1.5		16.9	23.3	999	69.4	0.4	206	0.0
268	8/27/2012			2.1		18.3	21.4	992	74.9	0.8	195	0.8
269	8/28/2012			2.0		18.0	23.7	995	74.2	0.5	190	0.3
270	8/29/2012			1.5		15.0	20.6	993	85.2	0.6	184	4.1

\* volatile PM-compounds, determined with parallel operated TEOM-FDMS-systems

Annex 6

Ambient conditions at field test sites

No.	Date	Test site	Mean PM <sub>2.5</sub> -conc. [µg/m <sup>3</sup> ]	PM <sub>2.5</sub> volatiles [µg/m <sup>3</sup> ]*	Ratio volatiles / PM <sub>2.5</sub> [%]	Mean ambient temperature [°C]	Max. ambient temperature [°C]	Ambient pressure [hPa]	Rel. humidity [%]	Wind velocity [m/s]	Wind direction [°]	Precipitation [mm]
271	8/30/2012	Teddington, Summer		0.9		12.6	17.7	1005	70.1	1.5	302	0.0
272	8/31/2012			1.2		15.3	19.4	1010	60.5	0.7	289	0.0
273	9/1/2012			1.8		16.6	22.7	1006	75.4	0.2	210	0.0
274	9/2/2012			2.7		16.8	19.5	1007	88.3	0.1	238	0.0
275	9/3/2012			3.3		18.4	26.9	1006	74.1	0.2	239	0.0
276	9/4/2012		8.8	3.0	33.8	18.9	26.6	1005	64.6	1.1	295	0.0
277	9/5/2012		10.8	1.2	10.8	14.7	21.9	1010	63.9	1.0	144	0.0
278	9/6/2012		11.3	2.5	22.1	16.3	23.2	1008	67.9	0.2	198	0.0
279	9/7/2012			2.4		17.5	28.4	1005	63.9	0.1	219	0.0
280	9/8/2012			2.6		17.1	28.3	998	64.8	0.1	208	0.0
281	9/9/2012			1.9		20.1	27.4	991	66.5	0.8	191	0.0
282	9/10/2012			2.5		17.5	21.0	991	75.3	0.9	192	0.0
283	9/11/2012		4.4	1.3	30.5	12.8	19.4	997	63.4	0.4	252	0.0
284	9/12/2012			1.5		13.4	20.4	998	72.4	0.5	267	2.5
285	9/13/2012		4.7	2.0	43.2	16.3	21.4	998	63.9	0.3	205	0.0
286	9/14/2012		5.2	1.8	34.2	14.3	21.3	997	70.8	0.7	257	0.0
287	9/15/2012		8.7	2.1	24.4	17.0	24.3	997	71.9	0.2	204	0.0
288	9/16/2012		3.4	1.6	46.7	15.6	19.6	994	75.9	0.2	207	0.0
289	9/17/2012		5.9	2.0	33.7	15.5	20.7	994	67.9	0.2	207	0.0
290	9/18/2012		6.4	1.0	14.9	11.7	19.3	1000	64.2	0.7	278	0.0
291	9/19/2012		8.2	1.4	17.3	12.2	18.3	1004	65.9	0.4	260	0.0
292	9/20/2012		5.7	1.9	32.9	13.3	19.3	1001	70.9	0.2	203	0.0
293	9/21/2012		5.3	2.1	39.9	12.1	17.3	998	77.3	0.4	273	1.3
294	9/22/2012		7.5	1.8	24.6	12.5	17.2	1000	60.6	0.8	89	0.0
295	9/23/2012		12.4	6.3	50.7	11.8	14.7	981	93.8	1.3	80	30.0
296	9/24/2012		3.2	2.3	70.8	12.2	16.6	971	80.9	0.5	190	10.2
297	9/25/2012		2.6	1.1	43.7	12.6	16.2	971	80.1	0.7	158	4.1
298	9/26/2012		5.7	0.8	14.7	12.4	16.2	980	88.7	0.6	222	2.5
299	9/27/2012		4.6	1.3	27.2	12.6	18.8	993	77.0	0.4	227	0.0
300	9/28/2012		3.4	1.4	41.1	12.3	18.3	997	84.5	0.4	193	1.5

\* volatile PM-compounds, determined with parallel operated TEOM-FDMS-systems

Report on the suitability test of the ambient air quality measuring system Model 5014i Beta with PM<sub>2.5</sub> pre-separator of the company Thermo Fisher Scientific for the component suspended particulate matter PM<sub>2.5</sub>,  
Report-No.: 936/21209885/H

Annex 6

Ambient conditions at field test sites

No.	Date	Test site	Mean PM2.5-conc. [µg/m³]	PM2.5 volatiles [µg/m³]*	Ratio volatiles / PM2.5 [%]	Mean ambient temperature [°C]	Max. ambient temperature [°C]	Ambient pressure [hPa]	Rel. humidity [%]	Wind velocity [m/s]	Wind direction [°]	Precipitation [mm]
301	9/29/2012	Teddington, Summer	8.3	1.7	20.7	10.4	17.5	1003	75.1	0.4	233	0.0
302	9/30/2012		4.7	2.2	47.4	14.9	17.9	997	79.1	0.7	186	2.5
303	10/1/2012		3.9	2.0	50.8	13.0	17.0	993	92.0	0.2	194	4.8
304	10/2/2012		3.7	2.5	66.7	13.8	18.3	989	84.5	0.7	186	2.8
305	10/3/2012		3.5	1.5	44.5	10.5	15.0	988	81.8	0.2	232	0.5
306	10/4/2012		3.5	1.8	51.2	13.8	17.3	989	76.1	0.5	198	4.6
307	10/5/2012		3.3	1.6	47.8	11.0	16.7	992	87.0	0.4	226	3.6
308	10/6/2012		11.4	1.6	14.3	8.9	16.2	999	81.2	0.3	231	2.3
309	10/7/2012		16.4	4.4	26.9	11.9	14.4	1003	81.3	0.2	160	1.8
310	10/8/2012		15.4	4.7	30.2	11.5	12.9	996	94.6	0.5	138	2.3
311	10/9/2012		8.4	3.1	37.1	12.0	15.0	999	71.6	0.7	82	1.3
312	10/10/2012		13.8	3.3	24.1	12.4	16.0	994	68.2	0.7	98	1.3
313	10/11/2012		6.4	3.4	53.8	13.4	15.6	983	90.0	0.5	171	1.3

\* volatile PM-compounds, determined with parallel operated TEOM-FDMS-systems

**Annex 7**

**Measured values from additional test site Bornheim, Summer 2013, related to actual conditions**

**Page 1 of 2**

Manufacturer		Thermo Fisher Scientific							PM <sub>2.5</sub>		Measured values in µg/m <sup>3</sup> (ACT)
Type of instrument		Model 5014i Beta									
Serial-No.		SN 1 / SN 2									
No.	Date	Ref. 1 PM <sub>2,5</sub> [µg/m <sup>3</sup> ]	Ref. 2 PM <sub>2,5</sub> [µg/m <sup>3</sup> ]	Ref. 1 PM <sub>10</sub> [µg/m <sup>3</sup> ]	Ref. 2. PM <sub>10</sub> [µg/m <sup>3</sup> ]	Ratio PM <sub>2,5</sub> /PM <sub>10</sub> [%]	SN 1 PM <sub>2,5</sub> [µg/m <sup>3</sup> ]	SN 2 PM <sub>2,5</sub> [µg/m <sup>3</sup> ]	Remark	Test site	
1	6/7/2013	17.0	16.1	28.6	29.9	56.6				Bornheim	
2	6/8/2013										
3	6/9/2013	14.0	13.6	20.1	21.3	66.9					
4	6/10/2013	16.1	15.4	26.1	27.1	59.1					
5	6/11/2013	13.0	12.2	20.8	20.7	60.7	18.3	15.8			
6	6/12/2013	7.1	6.4	14.6	14.0	47.4	8.2	7.6			
7	6/13/2013	5.6	5.4	13.4	12.7	42.1	8.2	6.4			
8	6/14/2013	5.0	5.7	10.8	10.8	49.3	6.5	4.8			
9	6/15/2013	5.1	5.3	10.6	10.2	50.0	7.1	7.4			
10	6/16/2013	7.3	7.6	16.7	16.6	44.8	9.1	8.3			
11	6/17/2013	12.2	13.3	21.3	20.9	60.3	14.4	14.0			
12	6/18/2013	17.8	17.3	28.6	29.1	60.9	21.1	19.2			
13	6/19/2013	31.9	32.7	48.7	48.5	66.5	28.1	23.7			
14	6/20/2013	8.7	10.1	15.5	14.9	62.1	12.4	10.9			
15	6/21/2013	4.2	4.5	7.2	6.8	62.2	5.9	4.9			
16	6/22/2013	3.3	4.1	5.7	5.9	63.8	3.6	4.6			
17	6/23/2013	3.1	3.0	4.6	5.5	59.8	3.7	3.6			
18	6/24/2013	8.7	8.0	13.9	13.2	61.8	10.4	8.2			
19	6/25/2013	6.3	6.6	12.9	12.7	50.4	8.9	7.7			
20	6/26/2013	9.1	9.4	14.6	14.5	63.5	11.4	8.2			
21	6/27/2013	9.8	9.6	14.2	13.8	69.2	11.1	8.5			
22	6/28/2013	8.8	8.7	14.2	14.7	60.4	9.1	6.5			
23	6/29/2013	6.0	5.8	11.7	11.5	50.9	6.9	6.0			
24	6/30/2013	7.4	6.9	14.6	14.4	49.4	8.1	6.0			
25	7/1/2013	7.7	7.6	13.4	13.2	57.7	8.9	8.1			
26	7/2/2013	7.9	7.9	12.5	12.0	64.6	9.5	12.7			
27	7/3/2013	3.6	3.8	9.0	9.9	39.1	6.3	5.2			
28	7/4/2013	7.5	7.9	13.5	13.6	56.9	8.1	9.0			
29	7/5/2013	12.9	13.1	20.9	19.9	63.8	14.4	13.8			
30	7/6/2013	13.3	13.1	18.7	18.5	71.1	15.0	13.5			

Report on the suitability test of the ambient air quality measuring system Model 5014i Beta with PM<sub>2.5</sub> pre-separator of the company Thermo Fisher Scientific for the component suspended particulate matter PM<sub>2.5</sub>,  
Report-No.: 936/21209885/H

**Annex 7**

**Measured values from additional test site Bornheim, Summer 2013, related to actual conditions**

Manufacturer Thermo Fisher Scientific Type of instrument Model 5014i Beta Serial-No. SN 1 / SN 2										PM <sub>2.5</sub> Measured values in µg/m <sup>3</sup> (ACT)
No.	Date	Ref. 1 PM <sub>2.5</sub> [µg/m <sup>3</sup> ]	Ref. 2 PM <sub>2.5</sub> [µg/m <sup>3</sup> ]	Ref. 1 PM <sub>10</sub> [µg/m <sup>3</sup> ]	Ref. 2 PM <sub>10</sub> [µg/m <sup>3</sup> ]	Ratio PM <sub>2.5</sub> /PM <sub>10</sub> [%]	SN 1 PM <sub>2.5</sub> [µg/m <sup>3</sup> ]	SN 2 PM <sub>2.5</sub> [µg/m <sup>3</sup> ]	Remark	Test site
31	7/7/2013	11.3	10.7	14.9	14.4	75.1	14.8	12.6		Bornheim
32	7/8/2013	11.3	10.6	16.3	16.1	67.6	13.7	11.8		
33	7/9/2013	14.2	14.5	24.9	22.6	60.4	18.1	14.9		
34	7/10/2013	9.7	10.2	19.1	17.5	54.4	12.5	12.0		
35	7/11/2013	13.6	14.3	26.6	24.9	54.2	18.8	15.5		
36	7/12/2013	16.5	16.8				23.2	17.3	Outlier Reference PM10	
37	7/13/2013	15.3	15.3	20.4	20.7	74.5	19.2	16.7		
38	7/14/2013	14.5	14.5	22.2	21.5	66.5	19.2	15.3		
39	7/15/2013	17.4	17.4	26.2	25.6	67.1	21.3	19.9		
40	7/16/2013	20.4	18.4	30.2	28.9	65.5	26.2	23.9		
41	7/17/2013	13.6	13.2	18.7	18.0	72.9	17.9	16.0		
42	7/18/2013			17.0	17.3		14.2	12.5	Outlier reference PM2,5	
43	7/19/2013	9.0	7.3	16.3	14.8	52.7	11.3	9.1		
44	7/20/2013	10.1	9.5	17.3	16.0	58.7	13.3	10.4		
45	7/21/2013	12.9	12.3	18.0	17.7	70.7	15.5	15.8		
46	7/22/2013	15.5	14.8	23.2	22.0	67.2	17.6	17.7		
47	7/23/2013	14.1	13.6	25.4	24.5	55.3	16.8	15.0		
48	7/24/2013	20.3	20.0	31.5	30.3	65.2	19.2	17.8		
49	7/25/2013	11.1	12.1	21.3	20.3	55.7	14.7	13.1		

Report on the suitability test of the ambient air quality measuring system Model 5014i Beta with PM<sub>2.5</sub> pre-separator of the company Thermo Fisher Scientific for the component suspended particulate matter PM<sub>2.5</sub>,  
Report-No.: 936/21209885/H

Annex 8

Ambient conditions at the additional test site Bornheim, Summer 2013

Page 1 of 2

No.	Date	Test site	Mean PM <sub>2.5</sub> -conc. [µg/m <sup>3</sup> ]	PM <sub>2.5</sub> volatiles [µg/m <sup>3</sup> ]*	Ratio volatiles / PM <sub>2.5</sub> [%]	Mean ambient temperature [°C]	Max. ambient temperature [°C]	Ambient pressure [hPa]	Rel. humidity [%]	Wind velocity [m/s]	Wind direction [°]	Precipitation [mm]
1	6/7/2013	Bornheim	16.6			21.7	29.1	1010	55.5	1.0	211	0.0
2	6/8/2013					21.1	26.8	1005	62.3	2.1	243	0.0
3	6/9/2013		13.8			15.6	19.2	1001	78.7	1.8	273	4.5
4	6/10/2013		15.7			14.4	18.1	1005	75.9	1.2	253	0.6
5	6/11/2013		12.6	3.2	25.4	18.8	23.8	1008	61.5	0.6	198	0.0
6	6/12/2013		6.8	1.3	19.5	21.1	23.7	1008	67.1	1.0	181	0.0
7	6/13/2013		5.5	0.3	4.7	17.0	27.6	1007	77.9	1.3	209	22.5
8	6/14/2013		5.3	1.1	21.4	16.1	21.2	1009	65.4	0.6	181	0.0
9	6/15/2013		5.2	0.4	6.9	17.2	22.6	1005	63.1	1.4	209	0.0
10	6/16/2013		7.5	0.6	8.6	17.7	23.7	1007	63.9	0.7	226	0.0
11	6/17/2013		12.7	1.7	13.3	23.3	29.7	1004	64.7	0.9	185	0.0
12	6/18/2013		17.6	2.3	13.0	27.2	34.8	1005	61.3	0.4	178	0.0
13	6/19/2013		32.3	4.6	14.3	26.9	35.0	1003	67.8	1.9	244	0.0
14	6/20/2013		9.4	3.0	32.3	20.5	25.1	1003	78.5	1.0	187	34.6
15	6/21/2013		4.3	1.1	24.6	19.0	23.4	1005	69.8	1.6	196	0.3
16	6/22/2013		3.7	1.3	35.0	19.0	23.7	1004	67.8	1.8	198	1.5
17	6/23/2013		3.0	0.4	13.6	16.2	19.2	1005	69.9	1.6	216	0.9
18	6/24/2013		8.4	1.0	12.2	14.2	17.4	1013	76.9	1.8	255	1.5
19	6/25/2013		6.5	0.9	14.6	13.4	16.8	1018	71.1	1.8	259	0.3
20	6/26/2013		9.3	1.9	20.8	13.9	16.7	1018	70.9	1.1	250	9.8
21	6/27/2013		9.7	2.1	21.1	13.2	17.1	1014	78.5	0.7	230	3.9
22	6/28/2013		8.8	2.1	24.3	14.1	16.7	1010	86.1	0.3	174	16.4
23	6/29/2013		5.9	0.7	12.4	14.8	18.8	1012	73.9	2.6	269	1.8
24	6/30/2013		7.2	1.3	18.3	17.7	22.4	1012	66.4	0.6	198	0.0
25	7/1/2013		7.7	1.4	17.9	18.8	25.4	1008	74.9	0.7	215	21.0
26	7/2/2013		7.9	1.6	20.5	21.6	27.1	1003	62.7	0.6	183	0.3
27	7/3/2013		3.7	0.7	19.0	17.5	20.1	1004	85.6	0.2	213	16.0
28	7/4/2013		7.7	0.4	5.3	20.0	24.7	1014	71.1	0.9	232	0.0
29	7/5/2013		13.0	1.3	10.4	19.8	24.8	1020	74.4	0.3	222	0.0
30	7/6/2013		13.2	2.0	15.4	22.4	29.3	1020	65.4	1.0	191	0.0

\* volatile PM-compounds, determined with parallel operated TEOM-FDMS-system

Report on the suitability test of the ambient air quality measuring system Model 5014i Beta with PM<sub>2.5</sub> pre-separator of the company Thermo Fisher Scientific for the component suspended particulate matter PM<sub>2.5</sub>,  
Report-No.: 936/21209885/H

Annex 8

Ambient conditions at the additional test site Bornheim, Summer 2013

No.	Date	Test site	Mean PM <sub>2.5</sub> -conc. [µg/m <sup>3</sup> ]	PM <sub>2.5</sub> volatiles [µg/m <sup>3</sup> ]*	Ratio volatiles / PM <sub>2.5</sub> [%]	Mean ambient temperature [°C]	Max. ambient temperature [°C]	Ambient pressure [hPa]	Rel. humidity [%]	Wind velocity [m/s]	Wind direction [°]	Precipitation [mm]
31	7/7/2013	Bornheim	11.0	1.1	10.0	23.1	29.7	1020	58.8	1.2	218	0.0
32	7/8/2013		11.0	1.4	12.9	23.0	29.8	1019	59.6	1.4	214	0.0
33	7/9/2013		14.4	2.7	19.2	23.4	29.9	1014	59.4	1.4	237	0.0
34	7/10/2013		10.0	1.8	18.1	19.5	24.2	1012	62.6	3.5	261	0.0
35	7/11/2013		14.0	1.4	10.0	15.7	19.7	1013	70.1	1.7	215	0.0
36	7/12/2013		16.7	3.4	20.4	16.5	21.9	1013	70.8	1.2	250	0.0
37	7/13/2013		15.3	2.8	18.5	17.7	22.9	1014	68.3	1.1	241	0.0
38	7/14/2013		14.5	3.7	25.5	18.9	24.2	1014	69.1	1.7	249	0.0
39	7/15/2013		17.4	2.0	11.3	21.3	27.8	1013	62.9	0.8	188	0.0
40	7/16/2013		19.4	2.7	14.2	22.5	29.2	1013	58.8	0.8	184	0.0
41	7/17/2013		13.4	2.0	14.8	23.2	29.3	1014	59.0	1.2	218	0.0
42	7/18/2013			2.0		24.5	31.6	1014	56.8	1.7	224	0.0
43	7/19/2013		8.2	1.7	21.3	23.5	29.1	1013	58.3	2.3	241	0.0
44	7/20/2013		9.8	1.7	17.5	21.1	26.6	1011	68.5	1.3	226	0.0
45	7/21/2013		12.6	1.8	14.6	25.3	32.3	1009	57.4	1.1	155	0.0
46	7/22/2013		15.2	2.2	14.4	27.6	35.1	1006	52.2	0.9	167	0.0
47	7/23/2013		13.8	1.8	12.8	25.5	33.7	1004	62.0	0.6	159	0.0
48	7/24/2013		20.1	5.0	24.9	21.7	27.6	1006	78.7	0.7	213	3.6
49	7/25/2013		11.6	4.5	38.4	22.5	28.1	1006	81.7	0.7	145	15.1

\* volatile PM-compounds, determined with parallel operated TEOM-FDMS-system

## Appendix 2

### Filter weighing procedure

#### A) German test sites (Cologne and Bornheim)

##### A.1 Carrying out the weighing

All weightings are done in an air-conditioned weighing room. Ambient conditions are 20 °C ±1 °C and 50 % ±5 % relative humidity, which conforms to the requirements of Standard EN 14907.

The filters used in the field test are weighed manually. In order to condition the filters (including control filters), they are placed on sieves to avoid overlap.

The specifications for pre- and post-weighing are specified beforehand and conform to the Standard.

Before sampling = pre-weighing	After sampling = post-weighing
Conditioning 48 h + 2 h	Conditioning 48 h + 2 h
Filter weighing	Filter weighing
Re-conditioning 24 h + 2 h	Re-conditioning 24 h + 2 h
Filter weighing and immediate packaging	Filter weighing

The balance is always ready for use. An internal calibration process is started prior to each weighing series. The standard weight of 200 mg is weighed as reference and the boundary conditions are noted down if nothing out of the ordinary results from the calibration process. Deviations of prior weighings conform to the Standard and do not exceed 20 µg (refer to Figure 56). All six control filters are weighed afterwards and a warning is displayed for control filters with deviations > 40 µg during evaluation. These control filters are not used for post-weighing. Instead, the first three acceptable control filters are used while the others remain in the protective jar in order to replace a defective or deviating filter, if necessary. Figure 57 shows an exemplary process over a period of more than four months.

All filters which display a difference of more than 40 µg between the first and second weighing are excluded from the pre-weighing process. Filters exhibiting deviations of more than 60 µg are not considered for evaluation after post-weighing, as conforming to standards.



Report on the suitability test of the ambient air quality measuring system Model 5014i Beta with PM<sub>2.5</sub> pre-separator of the company Thermo Fisher Scientific for the component suspended particulate matter PM<sub>2.5</sub>,  
Report-No.: 936/21209885/H

Page 205 of 417

Weighed filters are packed in separate polystyrene jars for transport and storage. These jars remain closed until the filter is placed in. Virgin filters can be stored in the weighing room for up to 28 days before sampling. Another pre-weighing is carried out if this period is exceeded.

Sampled filters can be stored for not more than 15 days at a temperature of 23 °C or less. The filters are stored at 7 °C in a refrigerator.

## A2 Filter evaluation

The filters are evaluated with the help of a corrective term in order to minimise relative mass changes caused by the weighing room conditions.

Equation:

$$\text{Dust} = \text{MF}_{\text{post}} - ( \text{M}_{\text{Tara}} \times ( \text{MKon}_{\text{post}} / \text{MKon}_{\text{pre}} ) ) \quad (\text{F1})$$

$\text{MKon}_{\text{pre}}$  = average mass of the 3 control filters after 48 h and 72 h pre-weighing

$\text{MKon}_{\text{post}}$  = average mass of the 3 control filters after 48 h and 72 h post-weighing

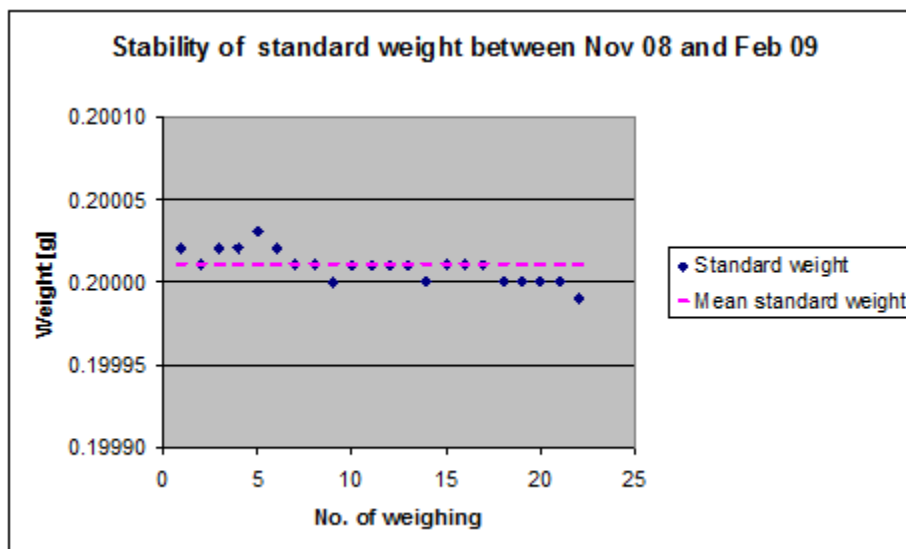
$\text{M}_{\text{Tara}}$  = average mass of the filter after 48 h and 72 h pre-weighing

$\text{MF}_{\text{post}}$  = average mass of the loaded filter after 48 h and 72 h post-weighing

Dust = corrected dust mass of the filter

This shows that the method becomes independent from weighing room conditions due to the corrective calculation. Influence due to the water content of the filter mass between virgin and loaded filter can be controlled and do not change the dust content of sampled filters. Hence, point 9.3.2.5 of EN 14907 is fulfilled.

The example of the standard weight between November 2008 and February 2009 shows that the permissible difference of max. 20 µg from the previous measurement is not exceeded.



**Figure 56:** Stability of standard weight

Report on the suitability test of the ambient air quality measuring system Model 5014i Beta with PM<sub>2.5</sub> pre-separator of the company Thermo Fisher Scientific for the component suspended particulate matter PM<sub>2.5</sub>,  
Report-No.: 936/21209885/H

Page 207 of 417

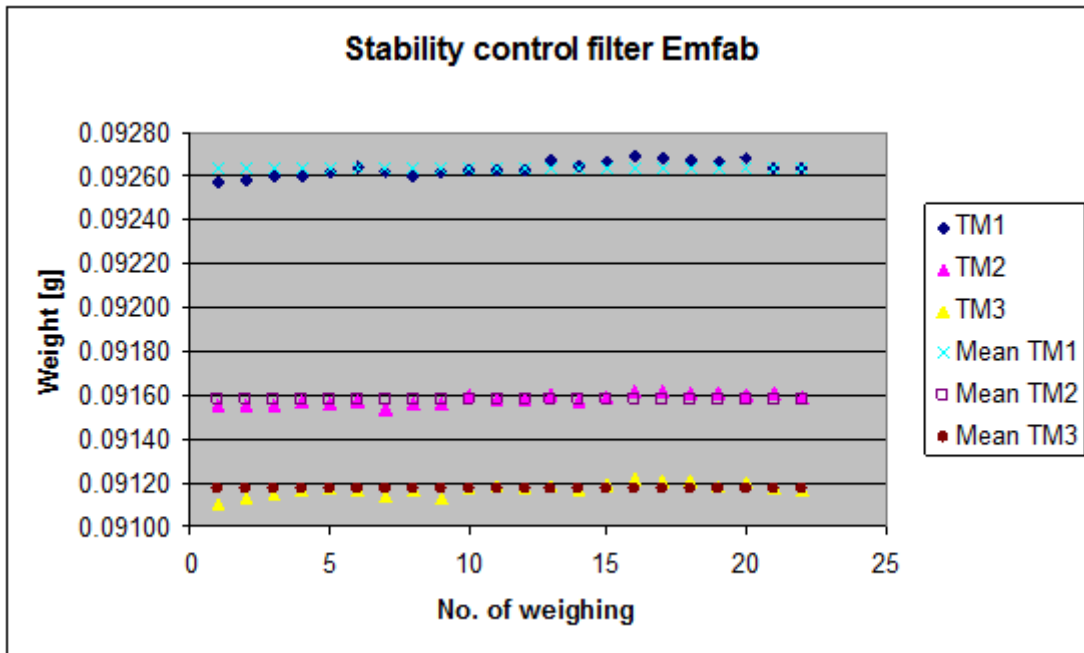
**Table 39:** Stability of standard weight

Date	Weighing No.	Standard weight g	Difference to the previous weighing µg
12.11.2008	1	0.20002	
13.11.2008	2	0.20001	-10
10.12.2008	3	0.20002	10
11.12.2008	4	0.20002	0
17.12.2008	5	0.20003	10
18.12.2008	6	0.20002	-10
07.01.2009	7	0.20001	-10
08.01.2009	8	0.20001	0
14.01.2009	9	0.20000	-10
15.01.2009	10	0.20001	10
21.01.2009	11	0.20001	0
22.01.2009	12	0.20001	0
29.01.2009	13	0.20001	0
30.01.2009	14	0.20000	-10
04.02.2008	15	0.20001	10
05.02.2009	16	0.20001	0
11.02.2009	17	0.20001	0
12.02.2009	18	0.20000	-10
18.02.2009	19	0.20000	0
19.02.2009	20	0.20000	0
26.02.2009	21	0.20000	0
27.02.2009	22	0.19999	-10

Marked in yellow = average value

Marked in green = lowest value

Marked in blue = highest value



**Figure 57:** Stability of the control filters

**Table 40:** Stability of the control filters

Weighing No.	Control filter No.		
	TM1	TM2	TM3
1	0.09257	0.09155	0.09110
2	0.09258	0.09155	0.09113
3	0.09260	0.09155	0.09115
4	0.09260	0.09157	0.09116
5	0.09262	0.09156	0.09117
6	0.09264	0.09157	0.09116
7	0.09262	0.09154	0.09114
8	0.09260	0.09156	0.09116
9	0.09262	0.09156	0.09113
10	0.09263	0.09160	0.09117
11	0.09263	0.09158	0.09118
12	0.09263	0.09158	0.09117
13	0.09267	0.09160	0.09118
14	0.09265	0.09157	0.09116
15	0.09266	0.09159	0.09119
16	0.09269	0.09162	0.09122
17	0.09268	0.09162	0.09121
18	0.09267	0.09161	0.09121
19	0.09266	0.09161	0.09118
20	0.09268	0.09160	0.09120
21	0.09264	0.09161	0.09117
22	0.09264	0.09159	0.09116
Average	0.09264	0.09158	0.09117
Standard deviation	3.2911E-05	2.4937E-05	2.8558E-05
rel. standard deviation	0.036	0.027	0.031
Median	0.09264	0.09158	0.09117
lowest value	0.09257	0.09154	0.09110
highest value	0.09269	0.09162	0.09122

Marked in yellow = average value

Marked in green = lowest value

Marked in blue = highest value

## B) UK test site (Teddington)

### B.1 Implementation of Weighing Protocols

NPL (National Physical Laboratory) were subcontracted to weigh filters manually for the field study. In line with EN14907 filters were kept in the weighing room for less than 28 days; the glove box used for weighing was maintained at  $(20 \pm 1) \text{ }^\circ\text{C}$  and  $(50 \pm 5) \%$ ; and filters were weighed twice before and after sampling. Table 41 summarises the conditioning and weighing timescales utilised:

**Table 41:** Conditioning and weighing timescales

Pre Sampling	Post Sampling
Condition minimum of 48 hours	Condition 48 hours
Weigh Filters	Weigh Filters
Condition 24 hours	Condition 24 hours
Weigh Filters	Weigh Filters

At the start of each weighing session the balance was exercised to remove mechanical stiffness, and then calibrated. At the start and end of each batch of filters, a 50 and 200 mg check weight were weighed. In line with the recommendations of the UK PM Equivalence Report [8], filters were weighed relative to a 100 mg check weight, and not a tare filter, as the latter was shown to lose mass over time. Four filters were weighed between check weights, as the balance drift over time had been shown to be small.

The **Check weight Mass (CM)** of the filter was calculated for each weighing session using **E A.1** below:

$$CM = \frac{(m_{check,Beg} + m_{check,End})}{2} \quad \text{E A.1}$$

Where:

$M_{check,bef}$  = Mass of check weight weighed immediately prior to sample filter.

$M_{check,aft}$  = Mass of check weight weighed immediately after sample filter.

The **Relative Mass (RM)** of the filter was calculated for each weighing session using **E A.2** below:

$$RM = m_{filter} - CM \quad \text{E A.2}$$

Where:

$m_{filter}$  = Mass of sample filter

**Particulate Mass (PM)** is calculated using the following equation in accordance with EN14907.

$$PM = \left( \frac{RM_{End1} + RM_{End2}}{2} \right) - \left( \frac{RM_{Beg1} + RM_{Beg2}}{2} \right) \quad \text{E A.3}$$

Where:

Beg1 denotes weighing session 1 prior to sampling

Beg2 denotes weighing session 2 prior to sampling

End1 denotes weighing session 1 after sampling

End2 denotes weighing session 2 after sampling

**Pre Spread (S<sub>Pre</sub>), Post Spread (S<sub>Post</sub>) and Blank Spread (S<sub>Blank</sub>)** were calculated using the following equations:

$$S_{Pre} = RM_{Anf1} - RM_{Anf2} \quad \text{E A.4}$$

$$S_{Post} = RM_{End1} - RM_{End2} \quad \text{E A.5}$$

$$S_{Blank} = \left( \frac{CM_{End2} + CM_{End1}}{2} \right) - \left( \frac{CM_{Anf2} + CM_{Anf1}}{2} \right) \quad \text{E A.6}$$

As with the UK PM Equivalence Report [8], it was not possible to weigh all filters within the 15 day timeframe suggested in EN14907.

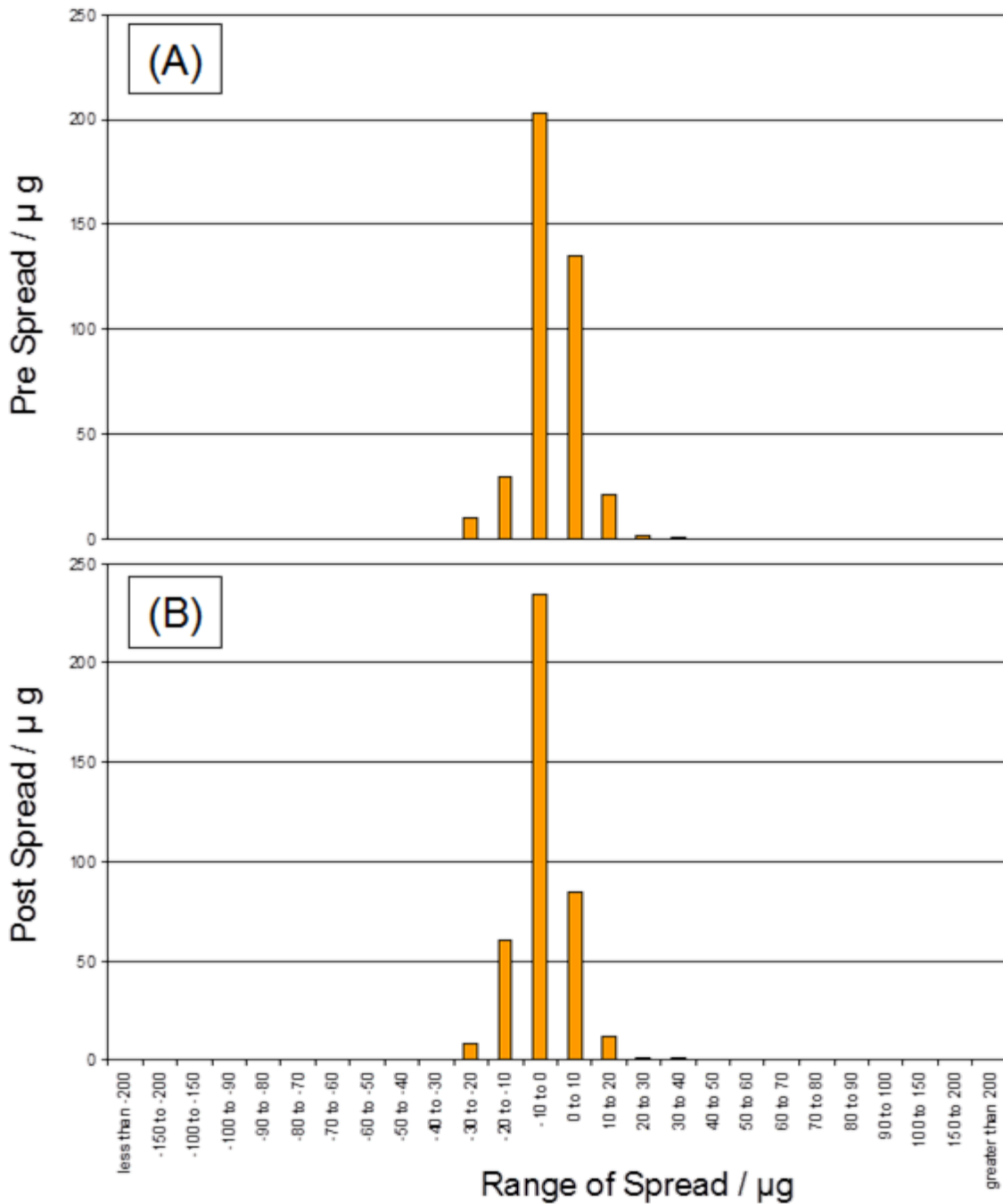
However, as filters were removed immediately from the reference samplers and placed in the refrigerator, it was not necessary to determine if T<sub>Ambient</sub> exceeded 23 °C. It is felt that as 15 days was impractical for a relatively small scale field study, it is less likely to be attainable if this methodology were adopted by a National or Regional network, and as such, the methodology employed herein is representative of how the reference samplers would be operated in practice.

## **A.2 Analysis of Protocols Employed**

The distributions of pre and post weight for all EMFAB filters weighed relative to the tare filter and check weight are shown in Figure 58. If filters lose relative mass between weightings, then the distribution will be shifted to the right, whereas if there is a gain in the relative mass the distribution will shift to the left. EN14907 states that unsampled filters should be rejected if the difference between the masses of the two pre weightings is greater than 40 µg. Similarly, EN14907 states that sampled filters should be rejected if the difference between the masses of the two post weightings is greater than 60 µg. Filters were not rejected based on these criteria. The observed distributions of repeat mass measurements are considered unlikely to have had a significant effect on the results.



**Figure 58:** Distribution for Emfab filters of (A) Pre spread weighed relative to the check weight and (B) Post spread weighed relative to the check weight.



## **Appendix 3**

### **Manuals**

# Model 5014i Beta

## Instruction Manual

Continuous Ambient Particulate Monitor

Part Number 106428-00

2Apr2014



© 2009 Thermo Fisher Scientific Inc. All rights reserved.

Specifications, terms and pricing are subject to change. Not all products are available in all countries. Please consult your local sales representative for details.

Thermo Fisher Scientific  
Air Quality Instruments  
27 Forge Parkway  
Franklin, MA 02038  
1-508-520-0430  
[www.thermo.com/aqi](http://www.thermo.com/aqi)

# WEEE Compliance

This product is required to comply with the European Union's Waste Electrical & Electronic Equipment (WEEE) Directive 2002/96/EC. It is marked with the following symbol:



Thermo Fisher Scientific has contracted with one or more recycling/disposal companies in each EU Member State, and this product should be disposed of or recycled through them. Further information on Thermo Fisher Scientific's compliance with these Directives, the recyclers in your country, and information on Thermo Fisher Scientific products which may assist the detection of substances subject to the RoHS Directive are available at: [www.thermo.com/WEEERoHS](http://www.thermo.com/WEEERoHS).



# About This Manual

This manual provides information about installing, operating, maintaining, and servicing the Model 5014*i* Continuous Ambient Particulate Monitor. It also contains important alerts to ensure safe operation and prevent equipment damage. The manual is organized into the following chapters and appendices to provide direct access to specific operation and service information.

- Chapter 1 “[Introduction](#)” provides an overview of product features, describes the principle of operation, and lists the specifications.
- Chapter 2 “[Installation](#)” describes how to unpack, setup, and startup the instrument.
- Chapter 3 “[Operation](#)” describes the front panel display screens, the front panel pushbuttons, and the menu-driven firmware.
- Chapter 4 “[Calibration](#)” provides the procedures for calibrating the analyzer and describes the required equipment.
- Chapter 5 “[Preventive Maintenance](#)” provides maintenance procedures to ensure reliable and consistent instrument operation.
- Chapter 6 “[Troubleshooting](#)” presents guidelines for diagnosing analyzer failures, isolating faults, and includes recommended actions for restoring proper operation.
- Chapter 7 “[Servicing](#)” presents safety alerts for technicians working on the analyzer, step-by-step instructions for repairing and replacing components, and a replacement parts list. It also includes contact information for product support and technical information.
- Chapter 8 “[System Description](#)” describes the function and location of the system components, provides an overview of the firmware structure, and includes a description of the system electronics and input/output connections.
- Chapter 9 “[Optional Equipment](#)” describes the optional equipment that can be used with this analyzer.
- Chapter 10 “[Model 5014i to 5030i Upgrade Procedures](#)” describes the 5014*i* to 5030*i* upgrade procedures.
- Appendix A “[Warranty](#)” is a copy of the warranty statement.

- Appendix B “[C-Link Protocol Commands](#)” provides a description of the C-Link protocol commands that can be used to remotely control an analyzer using a host device such as a PC or datalogger.
- Appendix C “[MODBUS Protocol](#)” provides a description of the MODBUS Protocol Interface and is supported both over RS-232/485 (RTU protocol) as well as TCP/IP over Ethernet.
- Appendix D “[Gesytac \(Bayern-Hessen\) Protocol](#)” provides a description of the Gesytac (Bayern-Hessen or BH) Protocol Interface and is supported both over RS-232/485 as well as TCP/IP over Ethernet.
- Appendix E “[ESM Protocol Commands](#)” provides a description of the ESM Protocol commands (from the prior FH62 platform) that can be used to remotely control an analyzer using a host device such as a PC or datalogger.





## Safety

Review the following safety information carefully before using the analyzer. This manual provides specific information on how to operate the analyzer, however, if the analyzer is used in a manner not specified by the manufacturer, the protection provided by the equipment may be impaired.


## Safety and Equipment Damage Alerts

This manual contains important information to alert you to potential safety hazards and risks of equipment damage. Refer to the following types of alerts you may see in this manual.



### Safety and Equipment Damage Alert Descriptions

Alert	Description
 <b>DANGER</b>	A hazard is present that could result in death or serious personal injury if the warning is ignored. ▲
 <b>WARNING</b>	A hazard or unsafe practice could result in serious personal injury if the warning is ignored. ▲
 <b>CAUTION</b>	A hazard or unsafe practice could result in minor to moderate personal injury if the warning is ignored. ▲
 <b>Equipment Damage</b>	A hazard or unsafe practice could result in property damage if the warning is ignored. ▲

### Safety and Equipment Damage Alerts in this Manual

Alert	Description
 <b>WARNING</b>	The Model 5014i is supplied with a three-wire grounded power cord. Under no circumstances should this grounding system be defeated. ▲



Alert	Description
 <b>CAUTION</b>	<p>If the equipment is operated in a manner not specified by the manufacturer, the protection provided by the equipment may be impaired. ▲</p> <p>The service procedures in this manual are restricted to qualified service personnel only. ▲</p> <p>The detector assembly should be replaced by a qualified technician knowledgeable in dealing with radiation precautions. By removing the detector assembly, the C-14 radioactive source is partially exposed. Safety glasses must be worn during this replacement procedure. The amount of C-14 meets the USNRC regulations as an exempt amount of radioactive source &lt;100 µCi.</p> <p>The detector window is very fragile. Handle with great care and do not wipe or touch the window. Furthermore, do not touch the solder cable connection (electrode) with your bare fingers. The oils from your skin can damage the detector.</p> <p>Safety glasses must be worn while replacing the detector assembly.</p> <p>If the LCD panel breaks, do not let the liquid crystal contact your skin or clothes. If the liquid crystal contacts your skin or clothes, wash it off immediately using soap and water. ▲</p>
 <b>Equipment Damage</b>	<p>Do not attempt to lift the analyzer by the cover or other external fittings. ▲</p> <p>Some internal components can be damaged by small amounts of static electricity. A properly grounded antistatic wrist strap must be worn while handling any internal component. ▲</p> <p>Disconnect the serial cable before changing the RS-232 and RS-485 selection to prevent damage to any equipment currently connected to the analyzer. ▲</p> <p>Do not use solvents or other cleaning products to clean the outside case. ▲</p> <p>Do not remove the LCD panel or frame from the LCD module. ▲</p> <p>The LCD polarizing plate is very fragile, handle it carefully. ▲</p> <p>Do not wipe the LCD polarizing plate with a dry cloth, as it may easily scratch the plate. ▲</p> <p>Do not use alcohol, acetone, MEK or other ketone based or aromatic solvent to clean the LCD module, but rather use a soft cloth moistened with a naphtha cleaning solvent. ▲</p>

Alert	Description
	Do not place the LCD module near organic solvents or corrosive gases. ▲
	Do not shake or jolt the LCD module. ▲

## Electrical/Safety Certifications



The product has been tested and has been documented to be in compliance with the following U.S. and Canadian safety standards:

UL Standard 61010-1:2004 2nd Edition  
CAN/CSA C22.2 No. 1010-1:2004 2nd Edition  
IEC 61326-2-3: 2006

Thermo Fisher Scientific certifies that this product operates in compliance with the EC Directive 89/336/EEC in reference to electrical emissions and immunity. Specifically, the equipment meets the requirements of EN 61326-1:1998 for Immunity and Emissions. In addition, the hardware has been tested for personal or fire safety hazards in accordance with EN61010-1:2001 (Safety) in fulfillment of EC Directive 73/23/EEC.

## FEM Statement

**Thermo Scientific 5014i Beta Continuous Particulate Monitor for PM10**

*Automated Equivalent Method: EQPM-1102-150*

“Thermo Scientific Model 5014i Beta Continuous Ambient Particle Monitor” configured with a 10 micron size selective inlet and a DHS, operated with a total actual flow of 16.67 L/min. and according to the Thermo Scientific 5014i Continuous Ambient Particulate Monitor operating manual.

## FCC Compliance


Changes or modifications to this unit not expressly approved by the party responsible for compliance could void the user’s authority to operate the equipment.

**Note** This equipment has been tested and found to comply within the limits for a Class A digital device, pursuant to Part 15 of the FCC Rules. These limits are designed to provide reasonable protection against harmful interference when the equipment is operated in a commercial environment. This equipment generates, uses, and can radiate radio frequency energy and, if not installed and used in accordance with the instruction manual, may cause harmful interference to radio communications. Operation of this equipment in a residential area is likely to cause harmful interference, in

which case the user will be required to correct the interference at his or her own expense. ▲

## WEEE Symbol

The following symbol and description identify the WEEE marking used on the instrument and in the associated documentation.

Symbol	Description
	Marking of electrical and electronic equipment which applies to waste electrical and electronic equipment falling under the Directive 2002/96/EC (WEEE) and the equipment that has been put on the market after 13 August 2005. ▲

---

## Where to Get Help

Service is available from exclusive distributors worldwide. Contact one of the phone numbers below for product support and technical information or visit us on the web at [www.thermo.com/aqi](http://www.thermo.com/aqi).

1-866-282-0430 Toll Free

1-508-520-0430 International

## About This Manual

Where to Get Help

# Contents

<b>Chapter 1</b>	<b>Introduction.....</b>	<b>1-1</b>
	Principle of Operation .....	1-3
	Specifications .....	1-7
<b>Chapter 2</b>	<b>Installation .....</b>	<b>2-1</b>
	Packaging and Transport.....	2-1
	Lifting.....	2-2
	Unpacking and Inspection .....	2-2
	Acceptance Testing and Startup Procedures .....	2-3
	Acceptance Test .....	2-4
	One-Point Temperature Verification .....	2-7
	One-Point RH Sensor Verification.....	2-7
	One-Point Barometric Pressure Verification.....	2-7
	One-Point Volumetric Flow Rate Verification .....	2-8
	Setup.....	2-9
	Inlet System .....	2-9
	Heater .....	2-10
	Sample Tube Extension Lengths .....	2-12
	Rack Mounting Option .....	2-12
	Monitor Installation.....	2-12
	Connecting External Devices .....	2-16
	Terminal Board PCB Assemblies.....	2-16
	I/O Terminal Board.....	2-16
	D/O Terminal Board .....	2-18
	25-Pin Terminal Board .....	2-19
	Power Connections .....	2-21
	Startup .....	2-21
	Data Content .....	2-22
	Shutdown .....	2-22
	Important Tips.....	2-22
<b>Chapter 3</b>	<b>Operation .....</b>	<b>3-1</b>
	Display.....	3-1
	Pushbuttons .....	3-2
	Soft Keys.....	3-3
	Alphanumeric Entry Screen.....	3-4
	Firmware Overview .....	3-4
	Power-Up Screen .....	3-6
	Run Screens .....	3-6

Ambient Conditions Run Screen.....	3-7
Sample Conditions Run Screen.....	3-8
Mass Sensor Data Run Screen.....	3-8
Main Menu.....	3-9
Range Menu .....	3-9
Concentration Units .....	3-10
Range.....	3-10
Set Custom Ranges .....	3-12
Custom Ranges.....	3-12
24-Hour Average.....	3-13
24-Hour Average Start Time.....	3-13
Calibration Factors Menu .....	3-13
PM Background.....	3-14
PM Coefficient .....	3-14
Instrument Controls Menu .....	3-15
Set Flow/Pump .....	3-15
Flow.....	3-15
Pump .....	3-16
Set Heater .....	3-16
Control .....	3-16
RH Threshold.....	3-17
Temperature Threshold .....	3-17
Filter Tape Control.....	3-17
Manual .....	3-18
Mass Limit .....	3-18
Next Time .....	3-18
Period .....	3-19
Counter .....	3-19
Volumetric Conditions .....	3-19
Temperature Compensation.....	3-20
Standard Temperature .....	3-20
Pressure Compensation .....	3-20
Standard Pressure.....	3-21
Datalogging Settings .....	3-21
Select Srec/Lrec .....	3-22
View Logged Data.....	3-22
Number of Records.....	3-23
Date and Time.....	3-23
Erase Log .....	3-24
Select Content.....	3-24
Choose Field Data.....	3-25
Concentrations.....	3-25
Other Measurements.....	3-25
Analog Inputs.....	3-27
Commit Content .....	3-28
Reset to Default Content .....	3-28

Configure Datalogging.....	3-28
Logging Period Min.....	3-29
Memory Allocation Percent.....	3-29
Data Treatment .....	3-30
Flag Status Data .....	3-30
Communication Settings.....	3-30
Serial Settings.....	3-31
Baud Rate .....	3-31
Data Bits .....	3-32
Parity .....	3-32
Stop Bits .....	3-32
RS-232/RS-485 Selection.....	3-33
Instrument ID.....	3-33
Gesytec Serial Number.....	3-34
Communication Protocol.....	3-34
Streaming Data Configuration .....	3-34
Streaming Data Interval .....	3-35
Choose Stream Data .....	3-35
Concentrations.....	3-35
Other Measurements.....	3-36
Analog Inputs.....	3-37
TCP/IP Settings.....	3-37
Use DHCP .....	3-37
IP Address.....	3-38
Netmask.....	3-38
Default Gateway .....	3-38
Host Name .....	3-39
Network Time Protocol Server.....	3-39
I/O Configuration.....	3-40
Output Relay Settings .....	3-40
Logic State .....	3-40
Instrument State .....	3-41
Alarms.....	3-41
Non-Alarm .....	3-42
Digital Input Settings.....	3-42
Logic State .....	3-42
Instrument Action.....	3-43
Analog Output Configuration (Select Channel) .....	3-43
Allow Over/Under Range.....	3-44
Analog Output Configuration (Select Action) .....	3-44
Select Range.....	3-45
Minimum and Maximum Value .....	3-45
Choose Signal to Output .....	3-46
Analog Input Configuration.....	3-48
Descriptor .....	3-48
Units.....	3-49

Decimal Places .....	3-49
Number of Table Points.....	3-49
Table Points.....	3-50
Volts .....	3-50
User Value .....	3-50
Screen Contrast.....	3-51
Service Mode .....	3-51
Date/Time .....	3-52
Timezone.....	3-52
Diagnostics Menu .....	3-53
Program Versions.....	3-53
Voltages .....	3-54
Motherboard Voltages.....	3-54
Interface Board Voltages .....	3-54
I/O Board Voltages .....	3-55
Detector Board Voltages .....	3-55
RH/Temperature .....	3-55
Pressure/Vacuum .....	3-56
Flow.....	3-56
Detector Status.....	3-56
CRn .....	3-57
Analog Input Readings.....	3-57
Analog Input Voltages.....	3-57
Digital Inputs.....	3-58
Relay States .....	3-58
Test Analog Outputs.....	3-58
Set Analog Outputs.....	3-59
Instrument Configuration .....	3-59
Contact Information .....	3-60
Alarms Menu .....	3-60
Instrument Alarms .....	3-61
Filter Tape Counter .....	3-61
Max Filter Tape Counter .....	3-61
Detector Alarms .....	3-62
Min and Max Alpha Alarms.....	3-62
Min and Max Beta Alarms .....	3-62
RH/Temperature Alarms .....	3-63
Ambient RH .....	3-63
Min and Max Ambient RH Limits.....	3-63
Sample RH .....	3-64
Min and Max Sample RH Limits.....	3-64
Ambient Temperature.....	3-65
Min and Max Ambient Temperature Limits .....	3-65
Flow Temperature.....	3-65
Min and Max Flow Temperature Limits .....	3-66
Board Temperature.....	3-66



Min and Max Board Temperature Limits.....	3-66
Pressure/Vacuum Alarms.....	3-67
Barometric Pressure.....	3-67
Min and Max Barometric Pressure Limits .....	3-68
Vacuum .....	3-68
Min and Max Vacuum Limits.....	3-68
Flow.....	3-69
Min and Max Flow Limits .....	3-69
Flow Alarms.....	3-69
Flow.....	3-70
Min and Max Flow Limits .....	3-70
Concentration Alarms.....	3-70
Average PM.....	3-71
Min and Max Average PM Concentration Limits .....	3-71
Instant PM.....	3-71
Min and Max Instant PM Concentration Limits.....	3-72
Service Menu .....	3-72
RH/Temperature Calibration.....	3-73
Ambient Temperature.....	3-73
Flow Temperature.....	3-74
Ambient Relative Humidity .....	3-74
Pressure/Vacuum Calibration.....	3-74
Barometer Pressure Calibration .....	3-75
Calibrate Barometer Pressure Span.....	3-75
Restore Default Calibration.....	3-76
Vacuum/Flow Calibration.....	3-76
Calibrate Vacuum/Flow Zero.....	3-76
Calibrate Vacuum Pressure Span.....	3-77
Calibrate Flow Pressure Span .....	3-77
Restore Default Calibration.....	3-78
Flow Calibration .....	3-78
Auto Flow Calibration .....	3-79
Manual Flow Calibration .....	3-79
Mass Calibration .....	3-79
Thermal Mass Coefficient .....	3-80
Vacuum Mass Coefficient .....	3-80
Barometer Mass Coefficient .....	3-80
Mass Coefficient .....	3-81
Auto Mass Coefficient.....	3-81
Manual Mass Coefficient .....	3-81
Alpha Efficiency Coefficient.....	3-82
Detector Calibration .....	3-82
Auto Detector Calibration.....	3-83
Manual Detector Calibration .....	3-83
Beta/Ref/Alpha Counts .....	3-83
High Voltage.....	3-84

Beta Ref Threshold .....	3-84
Alpha Threshold .....	3-84
Analog Output Calibration .....	3-85
Analog Output Calibrate Zero .....	3-85
Analog Output Calibrate Full-Scale .....	3-86
Analog Input Calibration .....	3-86
Analog Input Calibrate Zero .....	3-87
Analog Input Calibrate Full-Scale .....	3-87
Display Pixel Test .....	3-88
Restore User Defaults .....	3-88
Restore Factory Defaults .....	3-88
Password Menu .....	3-89
Set Password .....	3-89
Lock Instrument .....	3-90
Lock/Unlock and Local/Remote Operation .....	3-90
Change Password .....	3-90
Remove Password .....	3-91
Unlock Instrument .....	3-91

**Chapter 4**

<b>Calibration .....</b>	<b>4-1</b>
Frequency of Calibration .....	4-1
Equipment Required .....	4-1
Pre-Calibration .....	4-2
Calibration Procedure .....	4-2
RH/Temperature Calibration .....	4-3
Ambient Temperature .....	4-3
Ambient Relative Humidity .....	4-3
Flow Temperature .....	4-4
Pressure/Vacuum Calibration .....	4-4
Barometer Pressure Calibration .....	4-4
Calibrate Vacuum/Flow Zero .....	4-5
Calibrate Vacuum Pressure Span .....	4-5
Calibrate Flow Pressure Span .....	4-6
Flow Calibration .....	4-7
Auto Flow Calibration .....	4-7
Mass Calibration .....	4-7
Mass Coefficient .....	4-9
Auto Mass Coefficient .....	4-9
Detector Calibration .....	4-12
Auto Detector Calibration .....	4-12

**Chapter 5**

<b>Preventive Maintenance .....</b>	<b>5-1</b>
Safety Precautions .....	5-1
Replacement Parts .....	5-2
Cleaning the Outside Case .....	5-2

	Cleaning the Inlets .....	5-2
	U.S. EPA PM <sub>10</sub> Inlet .....	5-2
	European PM <sub>10</sub> /PM <sub>2.5</sub> Inlet .....	5-3
	Cyclone Maintenance.....	5-4
	Heater and Sample Tube.....	5-5
	Weather Proofing.....	5-5
	Fan Filter Inspection and Cleaning .....	5-5
	Pump Rebuilding.....	5-6
	Leak Test .....	5-6
	Filter Tape Replacement .....	5-7
	Greasing the Cam .....	5-8
<b>Chapter 6</b>	<b>Troubleshooting .....</b>	<b>6-1</b>
	Safety Precautions .....	6-1
	Troubleshooting Guides.....	6-1
	Board-Level Connection Diagrams .....	6-6
	Connector Pin Descriptions.....	6-8
	Service Locations.....	6-22
<b>Chapter 7</b>	<b>Servicing.....</b>	<b>7-1</b>
	Safety Precautions .....	7-3
	Firmware Updates.....	7-4
	Accessing the Service Mode.....	7-4
	Replacement Parts List .....	7-5
	Cable List.....	7-6
	External Device Connection Components .....	7-7
	Removing the Measurement Case Assembly and Lowering the Partition Panel .....	7-9
	Fuse Replacement .....	7-10
	Fan/Filter Replacement .....	7-11
	Detector Amplifier Assembly Replacement.....	7-12
	Detector Amplifier Board Calibration .....	7-13
	External Pump Replacement .....	7-14
	Pressure Board Replacement .....	7-15
	Pressure Board Calibration.....	7-17
	Analog Output Testing .....	7-18
	Analog Output Calibration .....	7-20
	Analog Input Calibration .....	7-21
	Calibrating the Input Channels to Zero Volts .....	7-21
	Calibrating the Input Channels to Full-Scale .....	7-22
	Thermistor Replacement .....	7-23
	I/O Expansion Board (Optional) Replacement .....	7-24
	Digital Output Board Replacement.....	7-26
	Motherboard Replacement.....	7-26
	Measurement Interface Board Replacement .....	7-27

Photo Interrupt Board Replacement.....	7-29
Proportional Valve Replacement .....	7-30
Detector Assembly Replacement .....	7-31
Flow RTD Replacement .....	7-33
Transformer Replacement .....	7-34
Radius Tube Replacement.....	7-35
Ambient RH/Temperature Replacement.....	7-36
Front Panel Board Replacement.....	7-38
LCD Module Replacement .....	7-39
Service Locations.....	7-41

**Chapter 8**

<b>System Description.....</b>	<b>8-1</b>
Hardware .....	8-1
Primary Measurement Head .....	8-3
Detector Amplifier .....	8-3
Cam Photo Interrupt Board.....	8-3
Counter Wheel Interrupt Board Assembly .....	8-3
Proportional Valve .....	8-3
Cam Motor.....	8-3
Tape Motor.....	8-3
Pressure Board.....	8-3
Firmware.....	8-4
Instrument Control.....	8-4
Monitoring Signals.....	8-4
Output Communication .....	8-4
Electronics .....	8-5
Motherboard.....	8-5
Measurement Interface Board .....	8-6
Measurement Interface Board Connectors.....	8-6
Flow Sensor System.....	8-6
Pressure Sensor Assembly .....	8-6
Detector Amplifier Assembly.....	8-6
Digital Output Board.....	8-7
I/O Expansion Board (Optional) .....	8-7
Front Panel Connector Board .....	8-7
I/O Components.....	8-7
Analog Voltage Outputs.....	8-7
Analog Current Outputs (Optional) .....	8-8
Analog Voltage Inputs (Optional) .....	8-8
Digital Relay Outputs .....	8-8
Digital Inputs.....	8-9
Serial Ports .....	8-9
RS-232 Connection .....	8-10
RS-485 Connection .....	8-10
Ethernet Connection.....	8-11
External Accessory Connector .....	8-11

<b>Chapter 9</b>	<b>Optional Equipment .....</b>	<b>9-1</b>
	Inlet Assemblies.....	9-1
	Sampling Tube Extensions.....	9-1
	I/O Expansion Board Assembly.....	9-1
	25 Pin Terminal Board Assembly.....	9-1
	Terminal Block and Cable Kits .....	9-2
	Cables .....	9-2
	Mounting Options.....	9-3
	Roof Flange Assembly .....	9-8
<b>Chapter 10</b>	<b>Model 5014i to 5030i Upgrade Procedures .....</b>	<b>10-1</b>
	Instrument Preparation .....	10-1
	Radius Tube Adapter Installation.....	10-5
	SHARP External Valve Installation .....	10-7
	SHARP Optics Assembly Installation.....	10-9
	Upgrade of the Heater Tube Assembly.....	10-10
	Model Label Change.....	10-11
	Power On Instrument .....	10-11
<b>Appendix A</b>	<b>Warranty .....</b>	<b>A-1</b>
<b>Appendix B</b>	<b>C-Link Protocol Commands.....</b>	<b>B-1</b>
	Instrument Identification Number.....	B-1
	Commands .....	B-2
	Commands List.....	B-3
	Measurements .....	B-9
	Alarms.....	B-11
	Diagnostics .....	B-17
	Datalogging.....	B-20
	Calibration.....	B-27
	Keys/Display .....	B-34
	Measurement Configuration .....	B-35
	Hardware Configuration .....	B-41
	Communications Configuration .....	B-43
	I/O Configuration.....	B-50
	Record Layout Definition .....	B-55
	Format Specifier for ASCII Responses.....	B-56
	Format Specifier for Binary Responses .....	B-56
	Format Specifier for Erec Layout.....	B-57
	Text .....	B-57
	Value String.....	B-57
	Value Source .....	B-57
	Alarm Information .....	B-58

Translation Table.....	B-58
Selection Table.....	B-58
Button Designator.....	B-58
Examples.....	B-59

<b>Appendix C</b>	<b>MODBUS Protocol.....</b>	<b>C-1</b>
	Serial Communication Parameters .....	C-1
	TCP Communication Parameters .....	C-2
	Application Data Unit Definition .....	C-2
	Slave Address.....	C-2
	MBAP Header .....	C-2
	Function Code.....	C-3
	Data.....	C-3
	Error Check .....	C-3
	Function Codes.....	C-3
	(0x01/0x02) Read Coils/Read Inputs .....	C-3
	(0x03/0x04) Read Holding Registers/Read Input Registers .....	C-5
	(0x05) Force (Write) Single Coil.....	C-7
	MODBUS Parameters Supported .....	C-8

<b>Appendix D</b>	<b>Gesytec (Bayern-Hessen) Protocol .....</b>	<b>D-1</b>
	Serial Communication Parameters .....	D-1
	TCP Communication Parameters .....	D-2
	Instrument Address .....	D-2
	Abbreviations Used .....	D-2
	Basic Command Structure .....	D-2
	Block Checksum Characters <BCC>.....	D-3
	Gesytec Commands .....	D-3
	Instrument Control Command (ST).....	D-3
	Data Sampling/Data Query Command (DA).....	D-4
	Measurements reported in response to DA command .....	D-7
	Operating and Error Status .....	D-7

<b>Appendix E</b>	<b>ESM Protocol Commands .....</b>	<b>E-1</b>
	ESM Commands Supported .....	E-1

# Figures

<b>Figure 1–1.</b> Model 5014 <i>i</i> Flow Schematic .....	1-4
<b>Figure 2–1.</b> Remove the Packing Material .....	2-3
<b>Figure 2–2.</b> Model 5014 <i>i</i> Sampling Room Air Under Stable Conditions .....	2-6
<b>Figure 2–3.</b> Model 5014 <i>i</i> Side View—inches [millimeters] .....	2-9
<b>Figure 2–4.</b> Model 5014 <i>i</i> Top View—inches [millimeters] .....	2-10
<b>Figure 2–5.</b> Model 5014 <i>i</i> Vertical View .....	2-11
<b>Figure 2–6.</b> Heater Assembly .....	2-13
<b>Figure 2–7.</b> Rear Panel Plumbing Schematic .....	2-15
<b>Figure 2–8.</b> I/O Terminal Board Views .....	2-17
<b>Figure 2–9.</b> Pin-Out of Rear Panel Connector .....	2-18
<b>Figure 2–10.</b> D/O Terminal Board Views .....	2-19
<b>Figure 2–11.</b> 25-Pin Terminal Board Views .....	2-20
<b>Figure 3–1.</b> Front Panel Display .....	3-2
<b>Figure 3–2.</b> Front Panel Pushbuttons .....	3-2
<b>Figure 3–3.</b> Flowchart of Menu-Driven Firmware .....	3-5
<b>Figure 3–4.</b> Pin-Out of Rear Panel Connector .....	3-11
<b>Figure 3–5.</b> Common Flags .....	3-26
<b>Figure 3–6.</b> Detector A Flags .....	3-27
<b>Figure 4–1.</b> Differential Pressure and Vacuum Calibration Ports .....	4-6
<b>Figure 5–1.</b> U.S. EPA PM <sub>10</sub> Inlet .....	5-3
<b>Figure 5–2.</b> European PM <sub>10</sub> Inlet .....	5-4
<b>Figure 5–3.</b> PM <sub>2.5</sub> Sharp-Cut-Cyclone .....	5-5
<b>Figure 5–4.</b> Inspecting and Cleaning the Fan .....	5-6
<b>Figure 5–5.</b> Replacing the Filter Tape .....	5-8
<b>Figure 6–1.</b> Board-Level Connection Diagram - Common Electronics .....	6-6
<b>Figure 6–2.</b> Board-Level Connection Diagram - Measurement System .....	6-7
<b>Figure 7–1.</b> Properly Grounded Antistatic Wrist Strap .....	7-4
<b>Figure 7–2.</b> Model 5014 <i>i</i> Component Layout .....	7-8
<b>Figure 7–3.</b> Removing the Measurement Case Assembly and Lowering the Partition Panel .....	7-9
<b>Figure 7–4.</b> Replacing the Fan .....	7-12
<b>Figure 7–5.</b> Replacing the Detector Amplifier Assembly .....	7-13
<b>Figure 7–6.</b> Replacing the Pump .....	7-15
<b>Figure 7–7.</b> Replacing the Pressure Board Assembly .....	7-16
<b>Figure 7–8.</b> Replacing the Pressure Board Assembly Plumbing Connection .....	7-16
<b>Figure 7–9.</b> Rear Panel Analog Input and Output Pins .....	7-19

<b>Figure 7–10.</b> Replacing the Thermistor.....	7-24
<b>Figure 7–11.</b> Replacing the I/O Expansion Board (Optional).....	7-25
<b>Figure 7–12.</b> Rear Panel Board Connectors.....	7-25
<b>Figure 7–13.</b> Replacing the Measurement Interface Board.....	7-28
<b>Figure 7–14.</b> Replacing the Photo Interrupt Board.....	7-29
<b>Figure 7–15.</b> Replacing the Proportional Valve.....	7-31
<b>Figure 7–16.</b> Replacing the Detector Assembly.....	7-33
<b>Figure 7–17.</b> Replacing the RTD.....	7-34
<b>Figure 7–18.</b> Replacing the Transformer.....	7-35
<b>Figure 7–19.</b> Replacing the Radius Tube.....	7-36
<b>Figure 7–20.</b> Replacing the Ambient RH/Temperature Assembly.....	7-38
<b>Figure 7–21.</b> Replacing the Front Panel Board and the LCD Module.....	7-39
<b>Figure 8–1.</b> Hardware Components.....	8-2
<b>Figure 9–1.</b> Bench Mounting.....	9-4
<b>Figure 9–2.</b> EIA Rack Mounting.....	9-5
<b>Figure 9–3.</b> Retrofit Rack Mounting.....	9-6
<b>Figure 9–4.</b> Rack Mount Option Assembly.....	9-7
<b>Figure 9–5.</b> Roof Flange Assembly.....	9-8
<b>Figure 9–6.</b> Securing the Roof Flange.....	9-9
<b>Figure 10–1.</b> SHARP Optics Connection Bracket.....	10-2
<b>Figure 10–2.</b> Tape Pick-up Spool Removal.....	10-3
<b>Figure 10–3.</b> Filter Tape Installation Pathway.....	10-4
<b>Figure 10–4.</b> Connecting Connection Bracket Wiring to Measurement Interface Board.....	10-5
<b>Figure 10–5.</b> Radius Tube Adapter Install.....	10-6
<b>Figure 10–6.</b> Radius Tube Adapter Alignment Check.....	10-6
<b>Figure 10–7.</b> Rear Valve Assembly Installation.....	10-7
<b>Figure 10–8.</b> Plumbing Diagram.....	10-8
<b>Figure 10–9.</b> Optics Installation.....	10-9
<b>Figure 10–10.</b> Connecting the Optics to the Optics Connector.....	10-9
<b>Figure 10–11.</b> Upgrading 5030i Heater Assembly.....	10-10
<b>Figure 10–12.</b> Connecting Heater to Optics Assembly Cover.....	10-11
<b>Figure 10–13.</b> Front Panel Label Replacement.....	10-11
<b>Figure B–1.</b> Flags Field.....	B-10



# Tables

<b>Table 1–1.</b> Model 5014 <i>i</i> Specifications .....	1-7
<b>Table 2–1.</b> Pressure Units Conversion.....	2-6
<b>Table 2–2.</b> I/O Terminal Board Pin Descriptions.....	2-17
<b>Table 2–3.</b> Default Analog Outputs .....	2-18
<b>Table 2–4.</b> D/O Terminal Board Pin Descriptions.....	2-19
<b>Table 2–5.</b> 25-Pin Terminal Board Pin Descriptions.....	2-20
<b>Table 3–1.</b> Front Panel Pushbuttons .....	3-3
<b>Table 3–2.</b> Standard Ranges.....	3-11
<b>Table 3–3.</b> Default Analog Outputs .....	3-12
<b>Table 3–4.</b> Analog Output Zero to Full-Scale .....	3-45
<b>Table 3–5.</b> Signal Type Group Choices.....	3-47
<b>Table 6–1.</b> Troubleshooting - General Guide .....	6-2
<b>Table 6–2.</b> Troubleshooting - Alarm Messages .....	6-4
<b>Table 6–3.</b> Motherboard Connector Pin Descriptions.....	6-8
<b>Table 6–4.</b> Measurement Interface Board Connector Pin Descriptions .....	6-13
<b>Table 6–5.</b> Front Panel Board Connector Pin Diagram.....	6-17
<b>Table 6–6.</b> I/O Expansion Board (Optional) Connector Pin Descriptions .....	6-19
<b>Table 6–7.</b> Digital Output Board Connector Pin Descriptions.....	6-20
<b>Table 7–1.</b> Model 5014 <i>i</i> Replacement Parts.....	7-5
<b>Table 7–2.</b> Model 5014 <i>i</i> Cables.....	7-6
<b>Table 7–3.</b> External Device Connection Components .....	7-7
<b>Table 7–4.</b> Analog Output Channels and Rear Panel Pin Connections.....	7-20
<b>Table 7–5.</b> Analog Input Channels and Rear Panel Pin Connections.....	7-20
<b>Table 8–1.</b> RS-232 DB9 Connector Pin Configuration .....	8-10
<b>Table 8–2.</b> RS-485 DB9 Connector Pin Configuration .....	8-10
<b>Table 9–1.</b> Cable Options.....	9-2
<b>Table 9–2.</b> Color Codes for 25-Pin and 37-Pin Cables .....	9-3
<b>Table 9–3.</b> Mounting Options .....	9-3
<b>Table B–1.</b> Error Response Messages .....	B-3
<b>Table B–2.</b> C-Link Protocol Commands .....	B-3
<b>Table B–3.</b> Record Output Formats .....	B-24
<b>Table B–4.</b> Stream Time Values.....	B-27
<b>Table B–5.</b> Standard Ranges .....	B-39
<b>Table B–6.</b> Contrast Levels.....	B-41
<b>Table B–7.</b> Allow Mode Command Values .....	B-46
<b>Table B–8.</b> Reply Termination Formats .....	B-48

## Tables

<b>Table B–9.</b> Set Layout Ack Values.....	B-49
<b>Table B–10.</b> Power Up Mode Values.....	B-50
<b>Table B–11.</b> Analog Current Output Range Values.....	B-51
<b>Table B–12.</b> Analog Voltage Output Range Values.....	B-52
<b>Table B–13.</b> Default Analog Output Channel Assignments.....	B-53
<b>Table C–1.</b> Read Coils for 5014 <i>i</i> .....	C-8
<b>Table C–2.</b> Read Registers for 5014 <i>i</i> .....	C-9
<b>Table C–3.</b> Write Coils for 5014 <i>i</i> .....	C-11
<b>Table D–1.</b> Operating Status for Model 5014 <i>i</i> .....	D-7
<b>Table D–2.</b> Error Status for Model 5014 <i>i</i> .....	D-8
<b>Table E–1.</b> Read Commands for 5014 <i>i</i> .....	E-1
<b>Table E–2.</b> Write Commands for 5014 <i>i</i> .....	E-2
<b>Table E–3.</b> Control Commands for 5014 <i>i</i> .....	E-2

# Chapter 1

## Introduction

The Model 5014*i* Continuous Ambient Particulate Monitor continuously measures the mass concentration of suspended and refined particulates (e.g., TSP, PM<sub>10</sub>, PM<sub>2.5</sub>, and PM<sub>1</sub>) by the use of beta attenuation. In addition, the influence of natural Radon (Rn-222) gas is corrected for as a mass refinement step allowing better sensitivity at lower ambient particulate concentrations.

In contrast to other beta attenuation monitors using Carbon-14 (C-14) as a source of the beta rays, the Model 5014*i* particulate sample collection area is located between both the C-14 source and the proportional counter. While ambient particulate is being deposited onto a filter tape sample spot, the dynamic filter loading is measured simultaneously by the attenuation of the C-14 source beta rays. As a result of this configuration, a continuous real-time measurement of airborne particulate is provided. It is not necessary to move the filter spot from the sample position to a separate detector position for zero and mass determinations (old step-wise method of beta attenuation monitors). Therefore, uncertainties associated with step-wise filter transport are eliminated by the use of this continuous ambient particulate monitoring method.

Another unique design of the Model 5014*i* is that it takes into consideration background interferences with known beta attenuation methods. When present, the daughter nuclides of the natural noble gas Radon (Rn-222) attach to airborne particulates, which are then collected on the sample filter during mass measurement. Some of the radioactive daughter nuclides are also an emitter of beta rays interfering with the measurement of the particulate mass. The effect of the interference is generally greatest during:

- The first 90 minutes after a filter change until the radiological equilibrium on the filter is reached
- Periods of rapidly changing Radon gas levels
- When the activity of the C-14 source is very low

## Introduction

### Principle of Operation

In the Model 5014*i*, a discrimination technique is applied whereby the count rate created by the airborne natural activity is measured and corrected for in the gross particulate count rate. This eliminates any interference and enables the possibility to use a C-14 source with reduced activity. The ability to count the potential interferences of Radon gas stems from the use of a proportional detector, which enables the Model 5014*i* to measure both  $\beta$  and  $\alpha$  particles. The proportional detector is filled with a rigid counting gas and has a life-time of more than 10 years with a <100  $\mu\text{Ci}$  C-14 source. Any deterioration of the detector performance will be identified before it has an effect on the particulate measurement by the continuous plateau check procedure performed during operation.

The sample flow rate is controlled by means of a proportional solenoid valve. This valve opening varies according to the flow rate measured across a precision orifice.

A complete particulate measuring assembly consists of the following main parts:

- Central Monitoring Unit (5014*i* Continuous Particulate Monitor)
- Ambient Inlet Sampling System (TSP, PM<sub>10</sub>, PM<sub>2.5</sub>)
- Dynamic Heater
- Diaphragm Vacuum Pump
- External Ambient T/RH Sensor Assembly
- Internal Data Recording Unit and External Communication Ports
- Optional 6-Ft. Insulated Extension Tube(s)
- Optional Tripod Support

The Model 5014*i* combines proven technology, easy to use menu-driven firmware, and advanced diagnostics to offer unsurpassed flexibility and reliability. The Model 5014*i* has the following features:

- 320 x 240 pixels graphics display
- Menu-driven firmware
- Field programmable ranges
- Multiple user-defined analog outputs
- Analog input options
- Linearity through all ranges
- User-selectable digital input/output capabilities
- Standard communications features include RS-232/485 and Ethernet

- C-Link, MODBUS, Gesytec (Bayern-Hessen), ESM Protocol, streaming data, and NTP (Network Time Protocol) protocols. Simultaneous connections from different locations over Ethernet.
- Radon gas activity measurement (Rn-222; noble gas) and mass refinement
- Flexible data storage configurations
- Volumetric air flow rate control with actual and standard conditions concentration data output
- Processor controlled calibration of all sensors
- Detector Life ~10 years
- C-14 activity below USA authorized limit values; shipped as non-hazardous material under Code UN2911; easy handling of the source and instrument. No license is needed in most countries.

For details of the analyzer's principle of operation and product specifications, see the following topics:

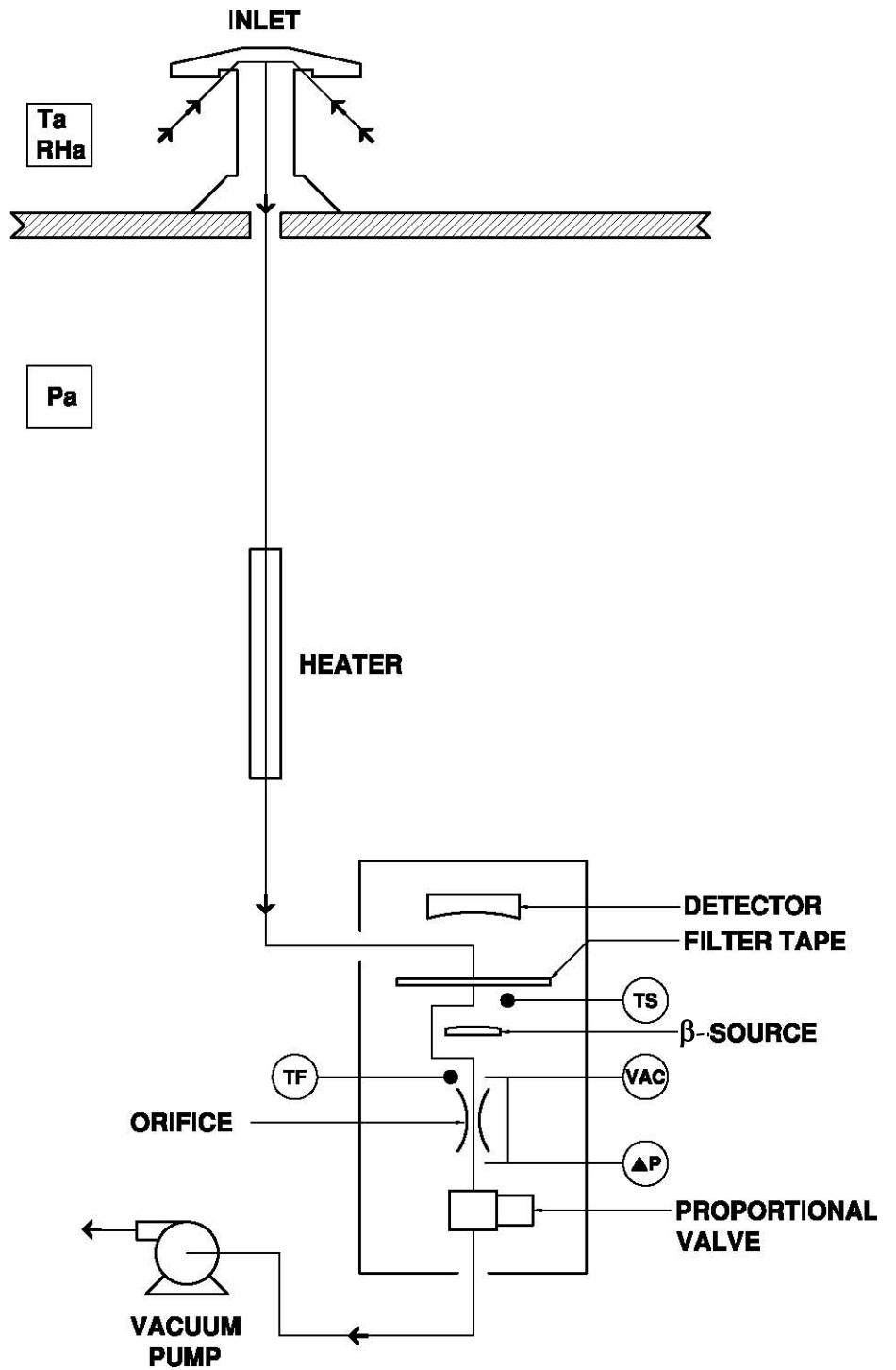
- [“Principle of Operation”](#) on page 1-3
- [“Specifications”](#) on page 1-7

Thermo Fisher Scientific is pleased to supply this continuous ambient particulate monitor. We are committed to the manufacture of instruments exhibiting high standards of quality, performance, and workmanship. Thermo service personnel are available for assistance with any questions or problems that may arise in the use of this instrument. For more information on servicing, see the [“Servicing”](#) chapter.

## Principle of Operation

The Model 5014*i* uses the radiometric principle of beta attenuation through a known area on a fibrous filter tape to continuously detect the mass of deposited ambient particles. Additionally, the Model 5014*i* measures alpha particle emissions directly from the ambient aerosol being sampled and excludes negative mass artifacts from the daughter nuclides of radon gas decay to achieve a refined mass measurement. Simultaneous refined mass measurements of sampled particulate on the filter tape and sample volume measurement provide a continuous concentration measurement of ambient particulate concentration.

[Figure 1–1](#) provides a schematic of the components used within the Model 5014*i*. Within the measurement chamber the four key components are 1) the proportional detector, 2) particle collection onto a glass fiber filter tape, 3) a vertical moving vacuum chamber plate, and 4) the  $^{14}\text{C}$  beta source <100  $\mu\text{Ci}$  (<3.7 Mbq). Based on this schematic, a description of operation is provided.



**Figure 1-1.** Model 5014i Flow Schematic

A clean filter spot is introduced by an automatic filter change to the combined sampling and detection chamber at least every 24 hours, usually centered at midnight. However, the official filter tape change frequency for TUV and U.S. EPA testing for both PM<sub>2.5</sub> and PM<sub>10</sub> is every 8 hours. The automatic filter changes are controlled by the instrument firmware which halts the pump operation, lowers the vacuum chamber plate, advances the filter tape a fixed length, raises the vacuum chamber plate, and initiates the pump operation and a zeroing of the sample spot. Immediately after a filter change, a new measurement cycle is initiated with an automatic zero adjustment of the mass signal. The filter change interval and time of day can be user adjusted. Additionally, automatic filter changes will occur if the mass on the filter exceeds 1,500 µg since the last filter change or if the flow rate through the filter tape is reduced by more than 5% due to potentially restrictive particle deposition.

Using the example of PM<sub>10</sub> monitoring, ambient air is drawn into a 10 micron (µm) size selective inlet which discriminates against particles with an equivalent aerodynamic diameter above 10 µm. This inlet has been approved previously through prior U.S. EPA designations (RFPS-0699-130, 131, and 132) and is also listed within 40 CFR Part 50, Appendix L as a 10-MICRON INLET (including model SA246b). The volumetric flow rate at the inlet entrance is 16.67 liters per minute (1 m<sup>3</sup>/hour). In addition, the ambient temperature and relative humidity is measured via a naturally aspirated radiation shield and standard sensor as part of the volumetric flow control and dynamic heating system.

**Note** Further particle discrimination would be achieved by inserting a PM<sub>2.5</sub> or PM<sub>1</sub> cyclone between the 10-micron inlet and sample tube. TSP inlets and European-style inlets are also available with the 5014*i*. ▲

The ambient particulate is then drawn down a vertically mounted heated sample tube. The heat applied to the sample is adjustable to either a fixed temperature or a RH-threshold at the filter spot. The purpose of heating the sample is to reduce particle bound water and to decrease the relative humidity (RH) of the sample stream. This is done to reduce positive artifact measurement that can potentially occur as a result of condensation on the filter tape or conditions of elevated humidity. The heater is controlled by the CPU and the power applied is proportional to the conditions.

At the location where the sampling tube attaches to the Model 5014*i* instrument case, a radial insulated tube joins the sampling tube to the collection chamber. The particulate is drawn onto the glass fiber filter tape between the proportional detector and the <sup>14</sup>C beta source. Here, the beta beam passes upwards through the filter tape and accumulated particulate layer. The intensity of the beta beam is attenuated with the increasing mass

load resulting in a reduced beta intensity measured by the proportional detector. From a continuously integrated count rate the mass on the filter tape is calculated. During sampling, the mass on the filter spot is always known and the rate of particulate accumulation is observed.

A continuous measurement of the flow rate determines the sample volume. A proportional valve is used to maintain the sample flow rate at its nominal value. From both integrated sample volume and mass detection the particulate concentration is calculated. At any given time the output signal delivers the concentration of particulate in actual or standard conditions.

The Model 5014*i* outputs particulate matter concentrations to the front panel display, the analog outputs, and also makes the data available over the serial or Ethernet connection.

Additionally, the Model 5014*i* proportional detector is sensitive to natural alpha activity of the aerosol passing through the sampling system. The additional alpha count rate is used to measure the presence of Radon gas and infer the daughter nuclides of Radon gas. These daughter nuclides create a small beta emission. This externally sampled beta emission is perceived by the detector to be a higher count rate and the higher the count rate, the less apparent mass detected. Therefore, by measuring the natural alpha activity due to Radon gas, the proportional beta interference from the daughter nuclide emissions are subtracted from the count rate to provide a refined mass measurement. This potential error from Radon gas interference may be (in lower strength radioactive devices; e.g.; <100  $\mu\text{Ci}$ ) as high as actual particle concentrations, especially after filter change or when the natural activity concentration changes. The Model 5014*i* has implemented this procedure to determine separately the natural activity in the aerosol and to eliminate this error. This procedure further allows the Model 5014*i* to provide a more stable reading at lower ambient particulate concentrations compared to similar methods. Furthermore, from this information the activity concentration of the natural noble gas Radon is derived.

The measurement chamber houses an RTD temperature sensor. The T-sensor directly measures the temperature of the incoming sample stream for a continuous air mass compensation, and the flow system. The flow and ambient sensor measurements are combined within a firmware algorithm to maintain an accurate measurement and control of volumetric flow at the inlet and through the differential orifice.

The Model 5014*i* also includes three pressure sensors to measure the differential pressure across a subsonic orifice, vacuum under the filter tape, and barometric pressure. The flow P-sensor is solely used for measurement at the orifice for flow rate control. The vacuum sensor is used for air mass compensation, as an indicator for clogging of the system and is included in



the volumetric flow control. The barometric P-sensor is used for air mass compensation and for volumetric flow rate regulation.

The volumetric flow system is built on a calibrated feedback signal from the CPU to the proportional valve signal. By using this flow control, flow stability is easily maintained.

## Specifications

Table 1–1 lists the specifications for the Model 5014*i*.

**Table 1–1.** Model 5014*i* Specifications

<b>Safety/Electrical Designations</b>	
Designed to meet:	
CE: EN 61326:1997 + A1:1998 + A2:2001 + A3:2003, EN:61010-1	
UL: 61010-1:2004	
CSA: C22.2 No. 61010-1:2004	
FCC: Part 15 Subpart B, Class B	
<b>Source and Detector</b>	
$\beta$ Source: Carbon-14, <3.7 MBq (<100 $\mu$ Ci) Sealed Source Device	
Proportional Detector	
<b>Standard System Configuration</b>	
Menu-driven software for user interaction via 320 x 420 pixels graphics display	
Connecting and Interface Cables, and Vacuum Pump	
3-foot heated sample tube	
Ambient T/RH Assembly	
Consumables for average first year's operation (ambient)	
<i>i</i> Port Software for Local or Remote Communication	
<b>Sample Heater</b>	
3-foot insulated heater tube	
Three Modes of Heater Control	OFF – Heater is turned off in non condensing environment TEMP – fixed sample temperature RH – Dynamic Heating of sample at set sample RH threshold (e.g., 50% RH)
<b>Instrument Performance (16.67 l/min, 1s, stable conditions)</b>	
Measurement Range:	0 to 1.0, 2.0, 3.0, 5.0, 10.0 mg/m <sup>3</sup> 0 to 100, 1,000, 2,000, 3,000, 5,000, 10,000 $\mu$ g/m <sup>3</sup>
Minimum Detection Limit:	<4 $\mu$ g/m <sup>3</sup> (1 hour) @ 2 $\sigma$ <1 $\mu$ g/m <sup>3</sup> (24-hour) @ 2 $\sigma$
Resolution: 0.1 $\mu$ g/m <sup>3</sup>	

---

Precision:  $\pm 2.0 \mu\text{g}/\text{m}^3$   $< 80 \mu\text{g}/\text{m}^3$ ;  $4\text{-}5 \mu\text{g}/\text{m}^3$   $> 80 \mu\text{g}/\text{m}^3$  (24-hour)

---

Accuracy for Mass Measurement:  $\pm 5\%$  using NIST-traceable mass foil set

---

### **Data Averaging and Output**

Real-time Mass Conc Average: 20 minutes

---

Long-Term Averaging: 60 to 3,600 sec and 24-hour

---

Data Output Rate: every 1 second

---

### **Operating Range**

The temperature of the sampled air may vary between  $-30$  and  $50$  °C. The 5014*i* units must be weather protected within the range of  $4$  °C to  $50$  °C.

An optional Complete Outdoor Enclosure provides complete weather protection.

---

Non-condensing;  $< 95\%$  RH inside 5014*i*

---

### **Sample Flow**

Volumetric flow control system uses a calibrated subsonic precision orifice and the measured ambient temperature and pressure to maintain constant volumetric flow rates.

Nominal Flow Rate: 16.67 L/min

Flow Precision  $\pm 2\%$  of measured value

Flow Accuracy  $< 5\%$  of measured value

---

### **Data Storage**

Internal data logging of user-specified variables; capacity of 190,000 records.

---

### **Filter Media**

Sample Filter: Glass fiber filter type (width 40 mm; length: 17 m) Whatman, Inc.

---

### **Inlet Accessories**

TSP

---

European or U.S. EPA PM10 Inlets

---

European or U.S. EPA PM2.5 Inlet Configurations

---

PM2.5 VSSC™

---

PM1.0 SCC

---

Tripod

---

### **Data Output and Input**

iPort software to view and change system operation from PC

---

Outputs: Selectable Voltage, RS232/RS485, TCP/IP, 10 Status Relays, and Power Fail Indication (standard). 0-20 or 4-20 mA Isolated Current Output (optional)

---

Inputs: 16 Digital Inputs (standard), Eight 0 to 10 VDC Analog Inputs (optional) 8 User-Defined Analog Outputs (0 -1 or 0 -5 VDC)

---

Protocols: C-Link, MODBUS, Geystitech (Bayern-Hessen), ESM Protocol, streaming data, and NTP (Network Time Protocol) protocols. Simultaneous connections from different locations over Ethernet.

---

---

2 User-Defined Contact Closure Alarm Circuits

---

4 Averaged Analog Inputs (0–5 VDC) with user-defined conversion to engineering units

---

**Data Storage**

Maximum of 190,000 Concentration records with date, time, and flags

---

Up to 32 types of logged data parameters, increased parameters reduces number of records

---

**Power Requirements**

Model 5014i: 100-240 VAC, 50-60 Hz

---

Pump: 115 VAC 50-60 Hz, 4.25 A

---

Maximum Power: 805 Watts (115V); 880 Watts (220-240V)

---

**Physical Dimensions**

W: 16.75" (42.5 cm) x D: 23" (58.4 cm) x H: 8.62" (21.9 cm)

---

Weight: 40 lbs. (19 kg)

---



## Chapter 2

# Installation

The following installation procedures for the Model 5014*i* describes packaging, lifting the instrument, unpacking the instrument, setup and installation, including the sample tube and pump, and attaching the analog and/or digital outputs to a recording device. The installation should always be followed by instrument calibration as described in the “[Calibration](#)” chapter of this manual.

This chapter provides the following recommendations and procedures for installing the instrument:

- “[Packaging and Transport](#)” on page 2-1
- “[Lifting](#)” on page 2-2
- “[Unpacking and Inspection](#)” on page 2-2
- “[Acceptance Testing and Startup Procedures](#)” on page 2-3
- “[Setup](#)” on page 2-9
- “[Connecting External Devices](#)” on page 2-16
- “[Startup](#)” on page 2-21
- “[Data Content](#)” on page 2-22
- “[Shutdown](#)” on page 2-22
- “[Important Tips](#)” on page 2-22

## Packaging and Transport

The Model 5014*i* instrument, power cord, and operator manual are shipped in an ISTA 2A-certified packaging and all other items/accessories are shipped separately. The ISTA 2A-certified packaging is comprised of the instrument within an inner box which is secured within an outer box using foam end-caps and corner bracing. In this configuration, the packaging is ready for shipping by carrier domestically and internationally.

The inner box that the instrument resides in is an ISTA 1A-certified packaging and is appropriate for transporting the instrument on local paved roads to the monitoring site. Precautions should be taken to secure this package from shifting during local transport.

Using the ISTA-2A packaging is strongly recommended for transporting the instrument over poor roads or on highways.

## Lifting

When lifting the instrument, use a procedure appropriate to lifting a heavy object, such as bending at the knees while keeping your back straight and upright. Grasp the instrument at the bottom in the front and at the rear of the unit. Although one person may lift the unit, it is desirable to have two persons lifting, one by grasping the bottom in the front and the other by grasping the bottom in the rear.



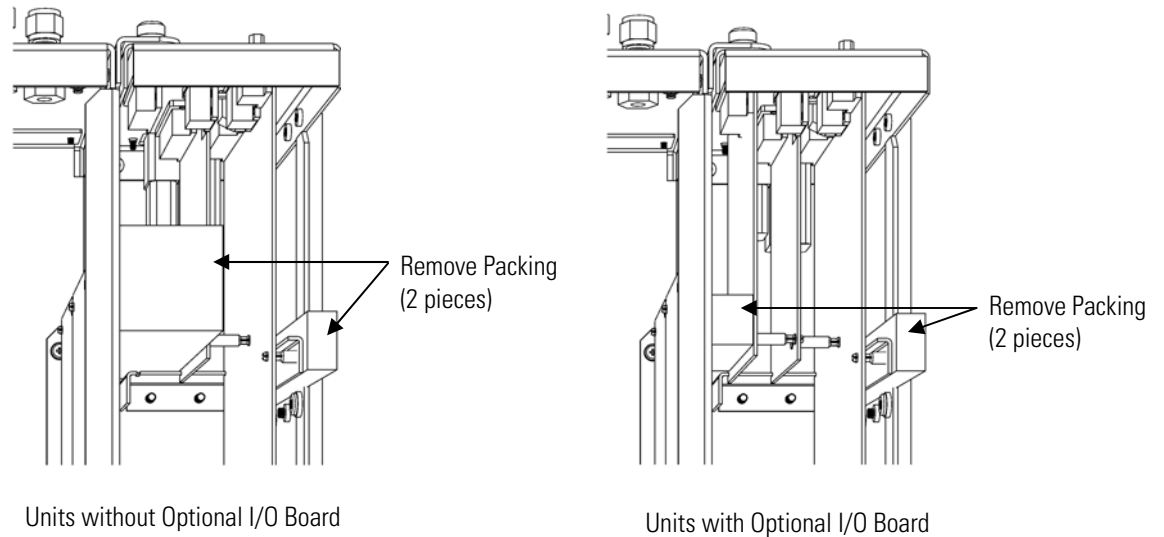
**Equipment Damage** Do not attempt to lift the instrument by the cover or other external fittings. ▲

## Unpacking and Inspection

If there is obvious damage to the shipping container when the instrument is received, notify the carrier immediately and hold for inspection. The carrier is responsible for any damage incurred during shipment.

Use the following procedure to unpack and inspect the instrument.

1. Remove the instrument from its shipping container(s) and set it on a table or bench that allows easy access to both the front and rear.
2. Remove the cover to expose the internal components.
3. Remove the packing material in the analyzer ([Figure 2–1](#)).



**Figure 2–1.** Remove the Packing Material

4. Check for possible damage during shipment.
5. Check that all connectors and circuit boards are firmly attached.
6. Re-install the cover.
7. Remove any protective plastic material from the case exterior.
8. Remove the external pump from its shipping container and place next to the instrument.

## Acceptance Testing and Startup Procedures

The Model 5014*i* has been bench tested and calibrated at the factory prior to shipping. The mass sensors, RH sensor, internal sample temperature sensor, flowmeter temperature sensor, external ambient temperature sensor, barometric pressure, and volumetric flow rate have been calibrated to traceable standards. For a quick start, proceed immediately to the “[Startup](#)” procedures and skip the “Bench Acceptance Test”.

To assure the best quality data, it is recommended that you perform an acceptance test. Furthermore, as part of a quality assurance program acceptance testing will be conducted prior to field installation. This is an excellent opportunity to compare the monitor to the primary and transfer standards that are being used within the monitoring program.

Furthermore, it is an opportunity to assure that the monitor is operating according to the manufacturer specifications.

After acceptance testing, a completed monitoring installation will require final volumetric flow rate verification.

## Acceptance Test

Prior to installing the Model 5014*i*, you should perform the acceptance testing procedures. These tests are conducted to evaluate the out-of-box performance of the instrument, perform any necessary calibrations prior to final site installation, and familiarize the user with the menu structure.

Use the following procedure to perform the bench acceptance test.

Equipment Required:

Model 5014*i*

Power Cord

Ambient Temperature/RH Cable Assembly

Vacuum Pump Assembly

Flow Adapter Assembly

NIST-traceable Thermometer

NIST-traceable Hygrometer

NIST-traceable Barometer

NIST-traceable Manometer(s)

NIST-traceable Volumetric Flow Transfer Standard

**(Do not use the heated sample tube assembly at this point.)**

9. After unpacking the instrument place the Model 5014*i* and accessories onto a table or bench located within a stable indoor environment. Remove the side-panel cover and inspect the filter tape. Leave cover OFF until after acceptance testing has been completed.

**Note** Prior to continuing with acceptance testing, the instrumentation and accessories should have sufficient time to equilibrate to room temperature due to temperature variations during shipping and/or storage. ▲

10. Following a sufficient equilibration period, connect the power cord to the rear of the instrument and to a properly grounded power supply.



**Note** If the Model 5014*i* turns ON at this point, set the power switch to the OFF position and then proceed. ▲

11. Connect the green vacuum tube to the pump intake and to the vacuum port mounted on the rear panel of the instrument by use of the push-connect fittings.
12. Connect the vacuum pump power cord to the white circular grounded power supply, labeled PUMP, on the rear panel of the instrument.
13. Connect the 4-pin Temperature/RH cable to the 4-pin connector labeled RH/TEMP on the rear of the monitor.
14. Be sure that the pressure sensor calibration port toggle switches on the rear panel are pushed outward and away from the barbed +/- Delta P.
15. Set monitor power switch to the ON position.


During startup, the *i*Series splash screen will be shown followed by a mechanical filter tape change and a cycling of the pump power.

To continue with the acceptance testing:

- From the Main Menu select Diagnostics > **RH/Temperatures**.

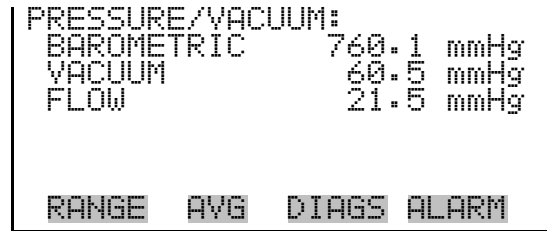
```
RH/TEMPERATURES:
AMBIENT RH      40.0  %
SAMPLE RH      36.4  %
AMBIENT TEMP   22.9  °C
FLOW TEMP     23.9  °C
BOARD TEMP    24.9  °C ↓
RANGE  AVG  DIAGS  ALARM
```

The RH/Temperatures screen (read only) displays the current relative humidity in percent and the temperature readings in °C. The board temperature is the air temperature measured by a sensor located on the measurement interface board.

- Press  to return to the Diagnostics menu, and choose **Pressure/Vacuum**.

## Installation

### Acceptance Testing and Startup Procedures



The Pressure/Vacuum screen (read only) displays the barometric, vacuum, and flow pressure readings in mmHg. The pressure is measured by a pressure transducer. The vacuum is the amount of vacuum under the filter tape. The flow pressure is the pressure differential across the orifice.

**Table 2–1.** Pressure Units Conversion

#### Pressure Conversions

---

$$\text{mmHg} = \text{atm} \times 0.75006$$

---

$$\text{mmHg} = \text{inHg} \times 25.4$$

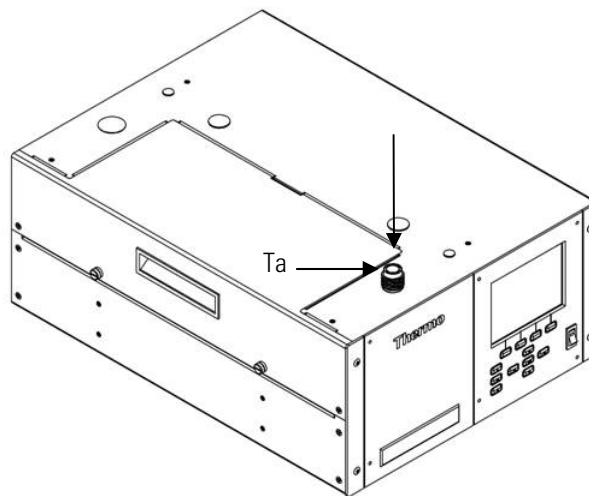
---

$$\text{mmHg} = \text{hPa} \times 0.75006$$

---

Assuming adequate time has passed for thermal equilibration (approximately 1 hour), and the vacuum pump has been drawing room air into the instrument, compare the ambient temperature, sample temperature, and flow temperature to your NIST traceable thermometer placed at the inlet tube (see [Figure 2–2](#)).

**Note** Please be sure that the pump exhaust or any other heat source is not influencing the sensor reading of the temperature/RH cable assembly. Please be sure the side panel has been removed for at least 60 minutes. ▲



**Figure 2–2.** Model 5014i Sampling Room Air Under Stable Conditions

## One-Point Temperature Verification

Record the temperature sensor readings from the Model 5014*i* and compare to your NIST-traceable thermometer. Each of these measurements should be within  $\pm 2$  °C tolerance of your NIST-traceable thermometer. Within this tolerance, the temperature sensors have passed the acceptance test.

If the sensors are slightly out of tolerance ( $\pm 3$  °C), the acceptance test should be classified as marginal. If the sensor performance is outside this range, please perform a temperature sensor calibration.

For more information about the temperature sensor calibration, see the “[Calibration](#)” chapter.

## One-Point RH Sensor Verification

Record the ambient RH sensor reading from the Model 5014*i* and compare to your NIST-traceable Hygrometer. The Model 5014*i* RH sensor should compare within  $\pm 2\%$  RH tolerance of your NIST-traceable hygrometer. If the RH sensor performance is within this tolerance, the acceptance test has passed.

**Note** The ambient temperature verification should be completed prior to performing the RH-sensor verification due to a thermal compensation applied to the RH-sensor. Furthermore, try to avoid RH comparisons  $< 30\%$  RH and  $> 80\%$  RH. ▲

If the RH sensor is slightly out of tolerance,  $\pm 3\%$  RH, the acceptance test should be classified as marginal. If the sensor performance is outside this range, please perform a RH-sensor calibration.

For more information about the RH sensor calibration, see the “[Calibration](#)” chapter.

It is recommended that the NIST-traceable hygrometer should also compare well with the RH-measurement used within a gravimetric laboratory that is part of a compliance program.

## One-Point Barometric Pressure Verification

Record the Model 5014*i* barometric pressure sensor reading. This value is in units of mmHg. If necessary, using the pressure unit conversion ([Table 2–1](#)) to convert your NIST-traceable measurement to units of mmHg for an appropriate comparison. The Model 5014*i* barometric sensor should compare within  $\pm 10.0$  mmHg tolerance of your NIST-traceable barometer. If the Model 5014*i* sensor performance is within this tolerance, the acceptance test has passed.

If the sensor is slightly out of tolerance, ±12 mmHg, the acceptance test should be classified as marginal. If the sensor performance is outside this range, please perform a sensor calibration.

For more information about the barometric pressure sensor calibration, see the “[Calibration](#)” chapter.

## One-Point Volumetric Flow Rate Verification

The flow rate of the Model 5014*i* should be verified during this acceptance test. Prior to this test it is important for the previous temperature and pressure acceptance tests to be completed. Should the ambient temperature, flow temperature or barometric sensors require calibration, this should be done prior to the flow rate verification.

- Press  to return to the Diagnostics menu, and choose **Flows**.



The Flow screen (read only) displays the volumetric flow rate in liters per minute. The flow is measured by the internal pressure board sensors.

Attach the small sample tube adapter to the Model 5014*i* inlet. Depending upon your NIST-traceable volumetric flow transfer standard (FTS), you may either attach your FTS now or add the flow audit adapter to accommodate any flexible tubing that your FTS may require. Allow 60 seconds to stabilize the flow after connecting.

Record the Model 5014*i* Volumetric Flow Rate as  $Q_m$  and the FTS flow rate as  $Q_i$ , assuring that both are being recorded in units of actual liters per minute. Take three readings each from  $Q_m$  and  $Q_i$  and average the respective values. Use the following equation to calculate the percent difference:

$$\%D = 100 \times \frac{Q_m - Q_i}{Q_i}$$

If %D is within ±4%, then the Model 5014*i* volumetric flow rate acceptance test has passed. If the Model 5014*i* volumetric flow rate is slightly out of tolerance, ±5%, the acceptance test should be classified as

marginal. If the volumetric flow rate performance is outside this range, please perform a volumetric flow calibration.

For more information about the volumetric flow rate calibration, see the “[Calibration](#)” chapter.

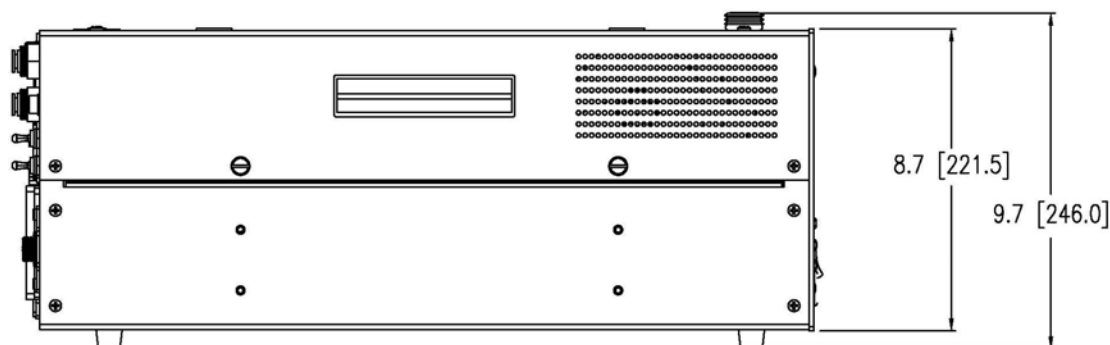
## Setup

Setting up this monitor includes siting the monitor per local government agency requirements, creating a waterproof inlet system installation with vertical support, connecting the inlet system to the instrument through the dynamic heater system, connecting vacuum lines, establishing datalogging setting, and making the power connections.

## Inlet System

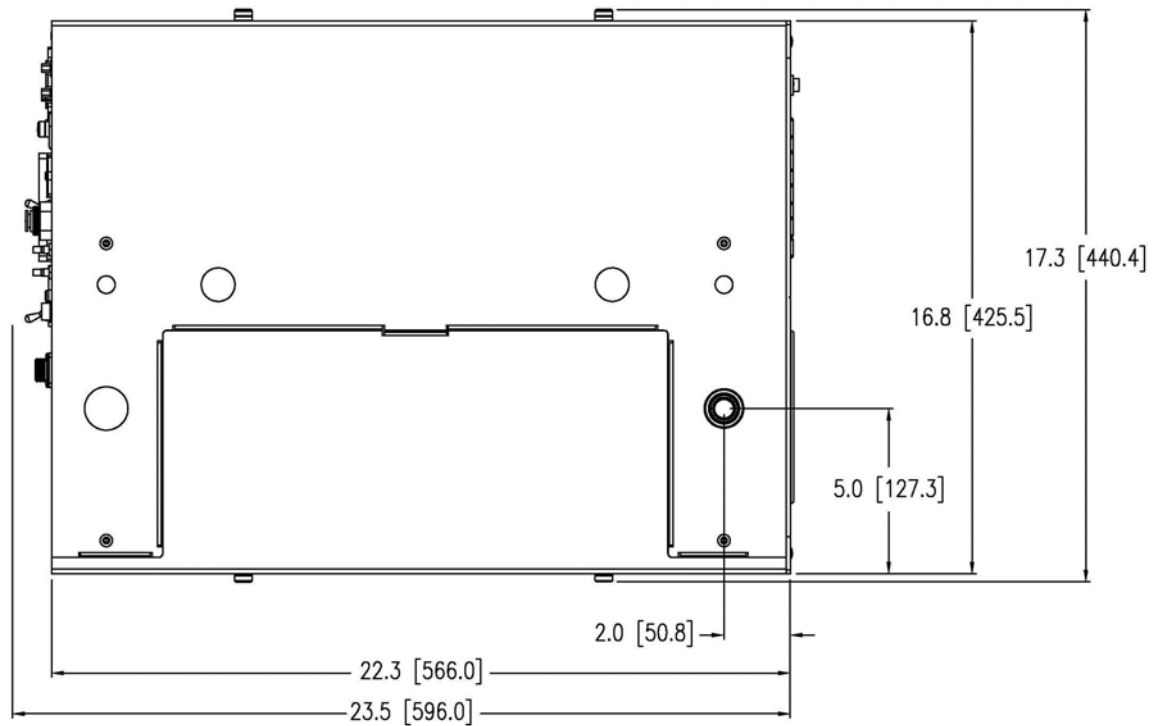
When siting the inlet system, it is best to first establish the instrument location and height within the air monitoring station. From whatever chosen surface the instrument is to rest on (rack or table top), add approximately 17 inches to that height to allow for overall height of the 5014*i* monitor.

Next allow approximately 40 inches to attach the heated sample tube to the top of the 5014*i* via 5/8-inch OD tubing unions that use Teflon ferrules.



**Figure 2–3.** Model 5014*i* Side View—Inches [millimeters]

It is also important to locate the roof flange installation in vertical alignment with the inlet of the instrument. By reviewing the top view drawing of the instrument ([Figure 2–3](#)), the roof flange must be centered in direct alignment with the 5/8-inch OD tube entering the 5014*i* instrument.



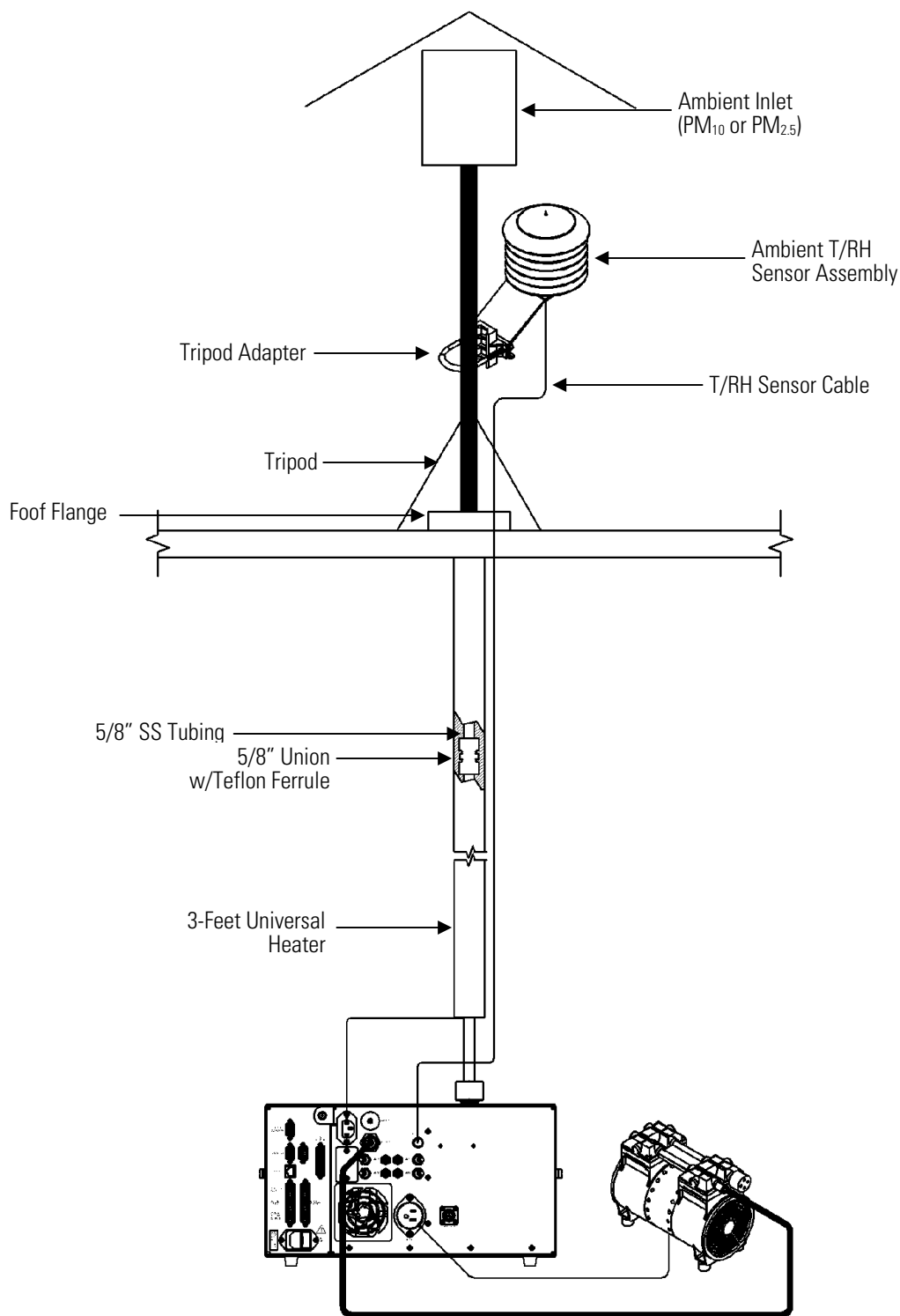
**Figure 2-4.** Model 5014*i* Top View—inches [millimeters]

## Heater

Once the x-y coordinates of the instrument and roof flange system are established and a waterproof flange system has been installed, perform a dry run by attaching the heated sample tube on top of the 5014*i* base. If the heated tube protrudes through the roof flange, either the instrument should be lowered or an elongated PVC sleeve and cap system should cover the heater while maintaining a waterproof seal. However, for the remainder of this description, it is assumed the heater will fit within the ceiling height of the air monitoring station.

Based on the vertical height requirements, use additional 5/8-inch OD stainless tubing and connectors to make up the difference between the desired inlet height and the top of the heater.

Additional routing is necessary for the ambient T/RH sensor assembly.



**Figure 2-5.** Model 5014*i* Vertical View

## Sample Tube Extension Lengths

There is one standard length of heated sample tube at one meter. Sample tube extensions are used for added height.

## Rack Mounting Option

One limiting factor when siting the Model 5014*i* is placement within a standard 19-inch rack mounting. Future planning should be made to reserve the topmost rack mounting position available due to the vertical positioning of the sample tube directly from the roof into the top of the Model 5014*i*. In addition, modification to the rack cabinet to accommodate the vertical tubing connection also needs to be considered prior to installation. For more information, see Chapter 9 “[Optional Equipment](#)”.

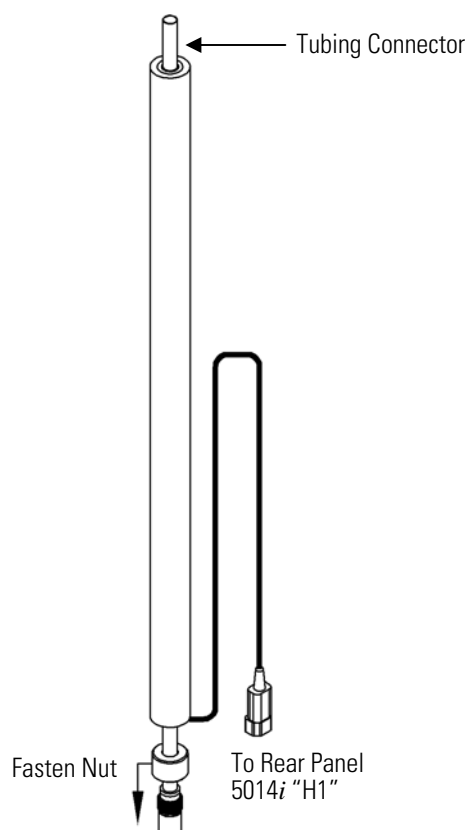
Review the following installation steps prior to field installation.

## Monitor Installation

Once all height requirements are established, the following steps are usually taken to complete the installation.

1. Remove cover to the 5014*i* base and inspect for proper filter tape installation.
2. Place 5014*i* unit in place of intended operation.
3. Attach the insulated heater tube assembly to the 5/8-inch OD tube on top of the 5014*i* ([Figure 2–6](#)).





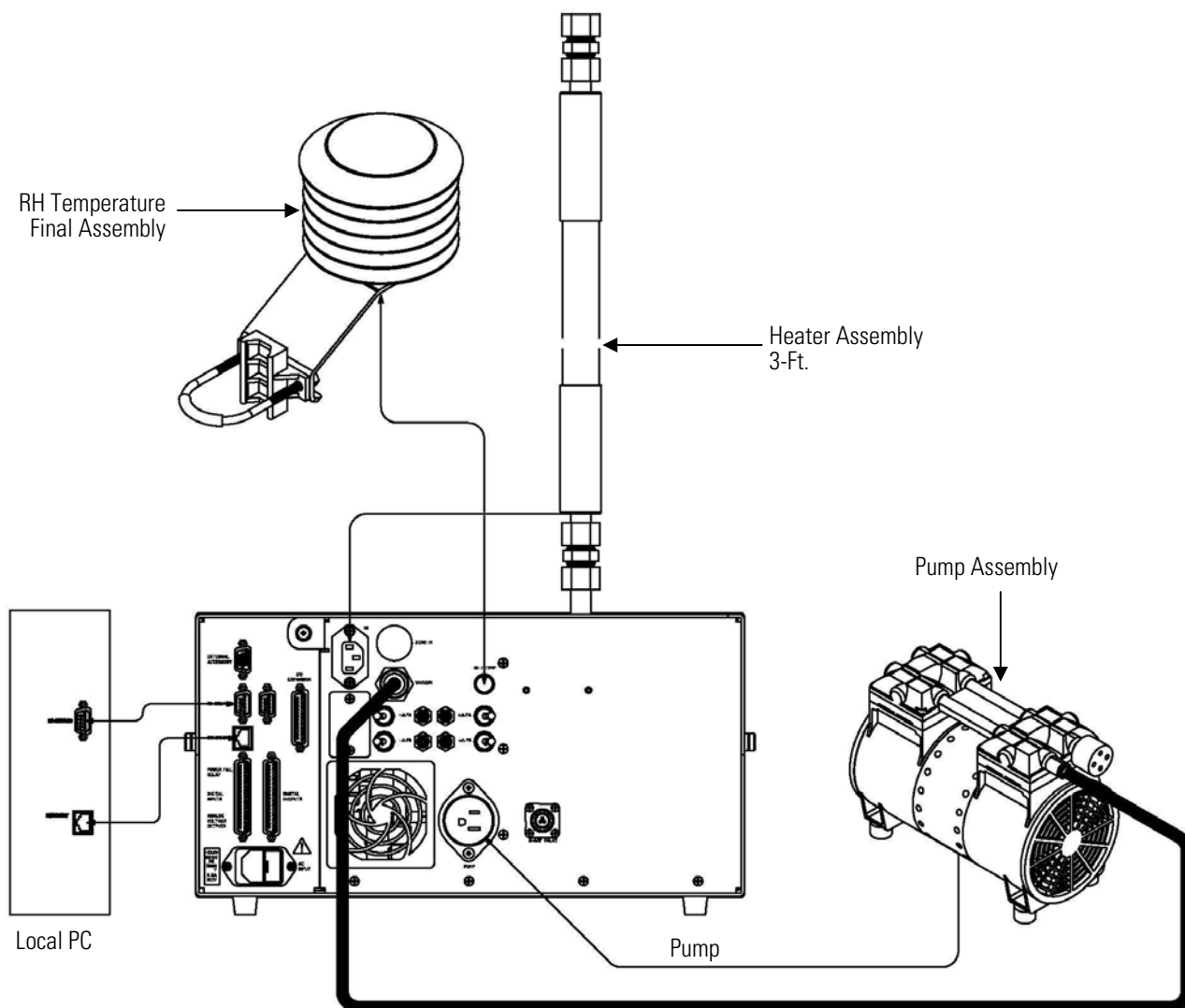
**Figure 2–6.** Heater Assembly

4. Attach a second tubing connector to the top of the heater tube.
5. Carefully push additional 5/8-inch OD stainless steel tubing through the roof flange and then drop into the tubing union on top of the heater.
6. Any exposed 5/8-inch OD stainless steel tubing should be insulated with additional pipe insulation inside the shelter.
7. Sleeve any additional water tight capping over the tubing that now extends above the roof line.
8. Sleeve the white Delrin plastic tripod adapter over the 5/8-inch OD tubing to an appropriate height to accommodate the tripod and ambient T/RH sensor assembly. Tighten this adapter against the stainless steel tubing using the two setscrews.

## Installation

### Setup

9. Sleeve the tripod over the tripod adapter to a proper height and tighten. Using the adjustable legs of the tripod, plumb the inlet tube assembly.
10. Attach the white ambient T/RH sensor radiation shield assembly onto a portion of the exposed tripod adapter.
11. Place the PM<sub>10</sub> or PM<sub>2.5</sub> inlet into the 5/8-inch stainless steel tubing (all burrs should have been removed during installation).
12. Feed one end of the black 25-foot T/RH cable through the roof flange assembly and connect to the bottom of the ambient T/RH assembly.
13. Connect the other end of the T/RH cable to the back of the instrument (RH Temp).
14. Attach the heater power connector to HEATER 1.



**Figure 2–7.** Rear Panel Plumbing Schematic

15. Using the available 3/8-inch green vacuum tubing, connect the intake of the pump to the vacuum fitting at the rear panel of the 5014i.
16. Plug the pump power chord into the AC PUMP receptacle at the rear of the 5014i base instrument.

## Connecting External Devices

Several components are available for connecting external devices to *iSeries* instruments.

These connection options include:

- Individual terminal board PCB assemblies (standard)
- Terminal block and cable kits (optional)
- Individual cables (optional)

For detailed information on the optional connection components, refer to the “[Optional Equipment](#)” chapter. For associated part numbers, refer to “[External Device Connection Components](#)” on page 7-7.

## Terminal Board PCB Assemblies

The terminal board PCB assemblies are circuit boards with a D-Sub connector on one side and a series of screw terminals on the other side. These assemblies provide a convenient mechanism for connecting wires from a data system to the analyzer’s I/O connectors.

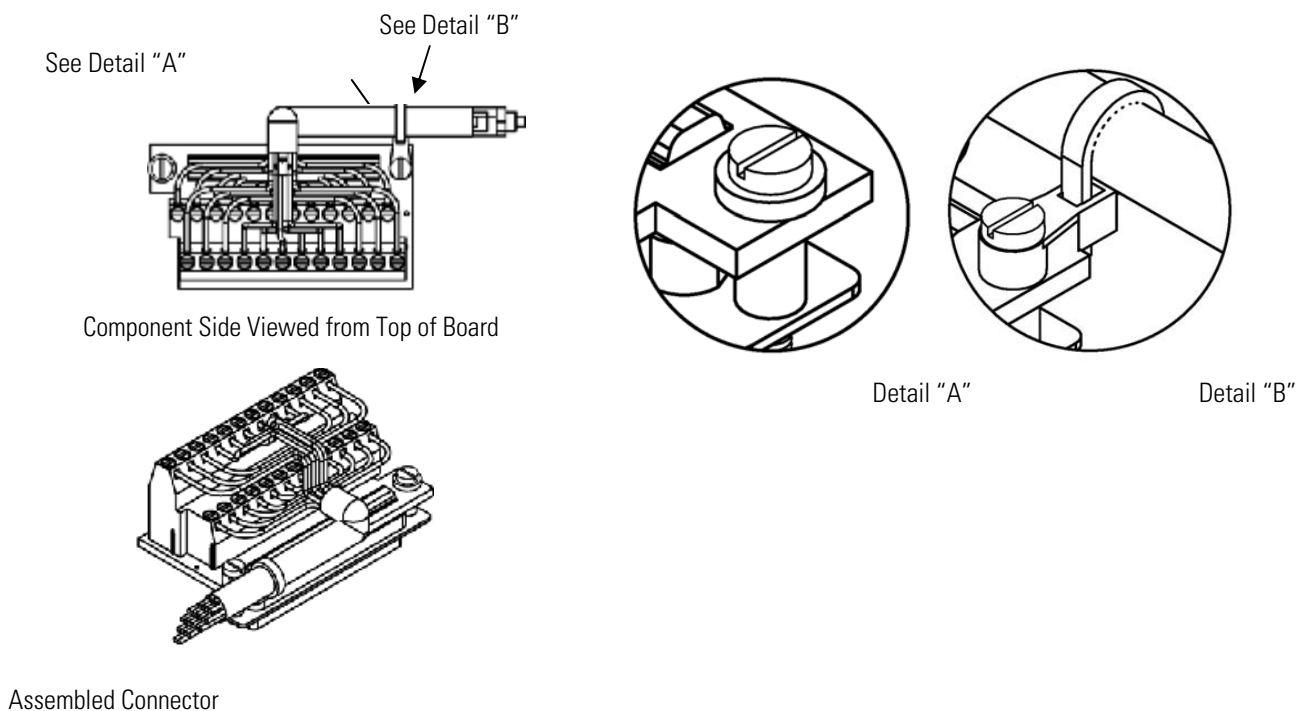
The following terminal board PCB assemblies are available for *iSeries* instruments:

- I/O terminal board PCB assembly, 37 pin (standard)
- D/O terminal board PCB assembly, 37 pin (standard)
- 25-pin terminal board PCB assembly, (included with optional I/O expansion board)

## I/O Terminal Board

[Figure 2–8](#) shows the recommended method for attaching the cable (customer supplied) to the terminal board using the included tie-down and spacer. [Table 2–2](#) identifies the connector pins and associated signals.

**Note** Not all of the I/O available in the instrument is brought out on the supplied terminal board. If more I/O is desired, an alternative means of connection is required. See optional “[Terminal Block and Cable Kits](#)”. ▲



**Figure 2–8.** I/O Terminal Board Views

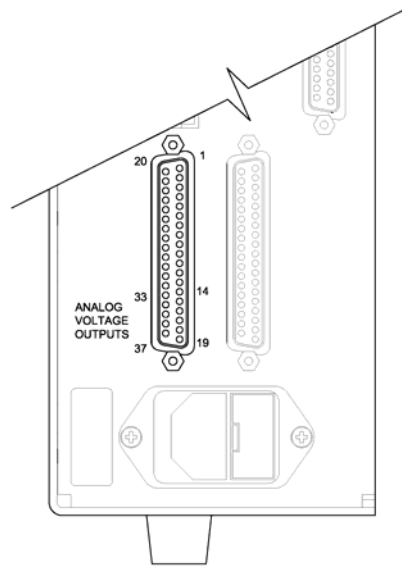
**Table 2–2.** I/O Terminal Board Pin Descriptions

Screw	Signal Description	Screw	Signal Description
1	Analog1	13	Power_Fail_NC
2	Analog ground	14	Power_Fail_COM
3	Analog2	15	Power_Fail_NO
4	Analog ground	16	TTL_Input1
5	Analog3	17	TTL_Input2
6	Analog ground	18	TTL_Input3
7	Analog4	19	TTL_Input4
8	Analog ground	20	Digital ground
9	Analog5	21	TTL_Input5
10	Analog ground	22	TTL_Input6
11	Analog6	23	TTL_Input7
12	Analog ground	24	Digital ground

## Installation

### Connecting External Devices

The analog outputs are arranged on the rear panel connector as shown in [Figure 2–9](#). See [Table 2–3](#) for channels and pin connections.



**Figure 2–9.** Pin-Out of Rear Panel Connector

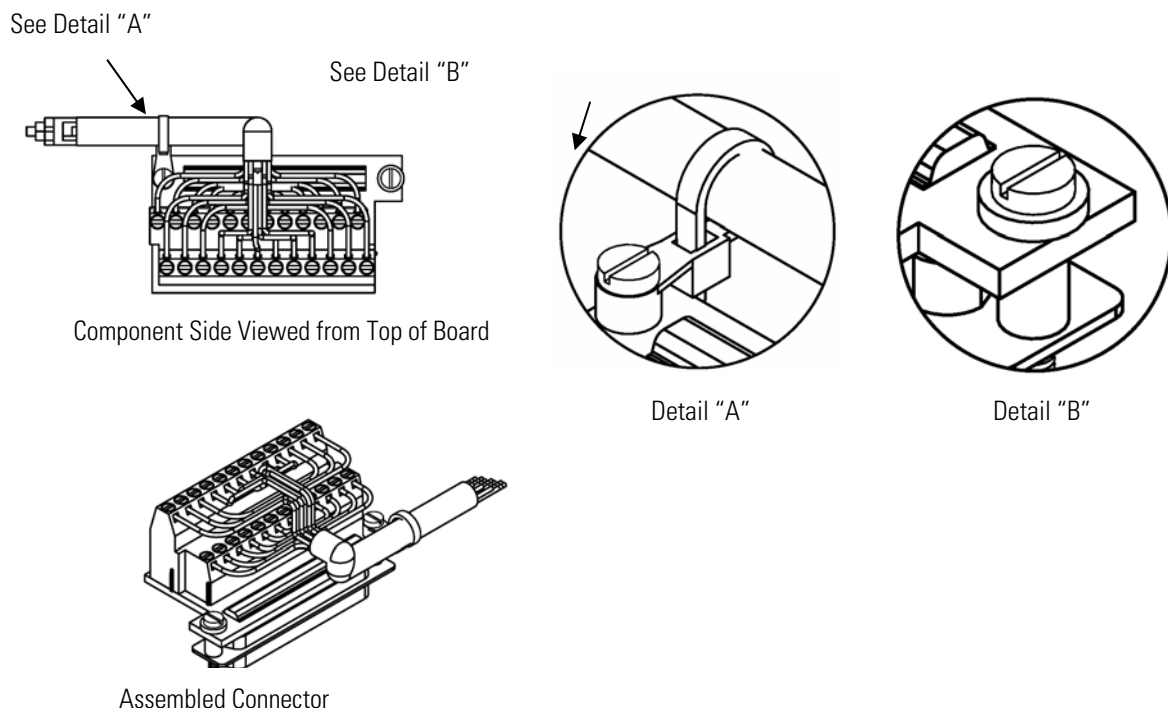
**Table 2–3.** Default Analog Outputs

Channel	Connector Pin	I/O Terminal Pin	Description
1	14	1	PM
2	33	3	AVG PM
3	15	5	Flow
4	34	7	Ambient Temperature
5	17	9	Flow Temperature
6	36	11	Ambient Relative Humidity
Ground	16, 18, 19, 35, 37	2, 4, 6, 8, 10, 12	Signal Ground

**Note** All channels are user definable. If any customization has been made to the analog output configuration, the default selections may not apply. ▲

### D/O Terminal Board

[Figure 2–10](#) shows the recommended method for attaching the cable (customer supplied) to the terminal board using the included tie-down and spacer. [Table 2–4](#) identifies the connector pins and associated signals.



**Figure 2–10.** D/O Terminal Board Views

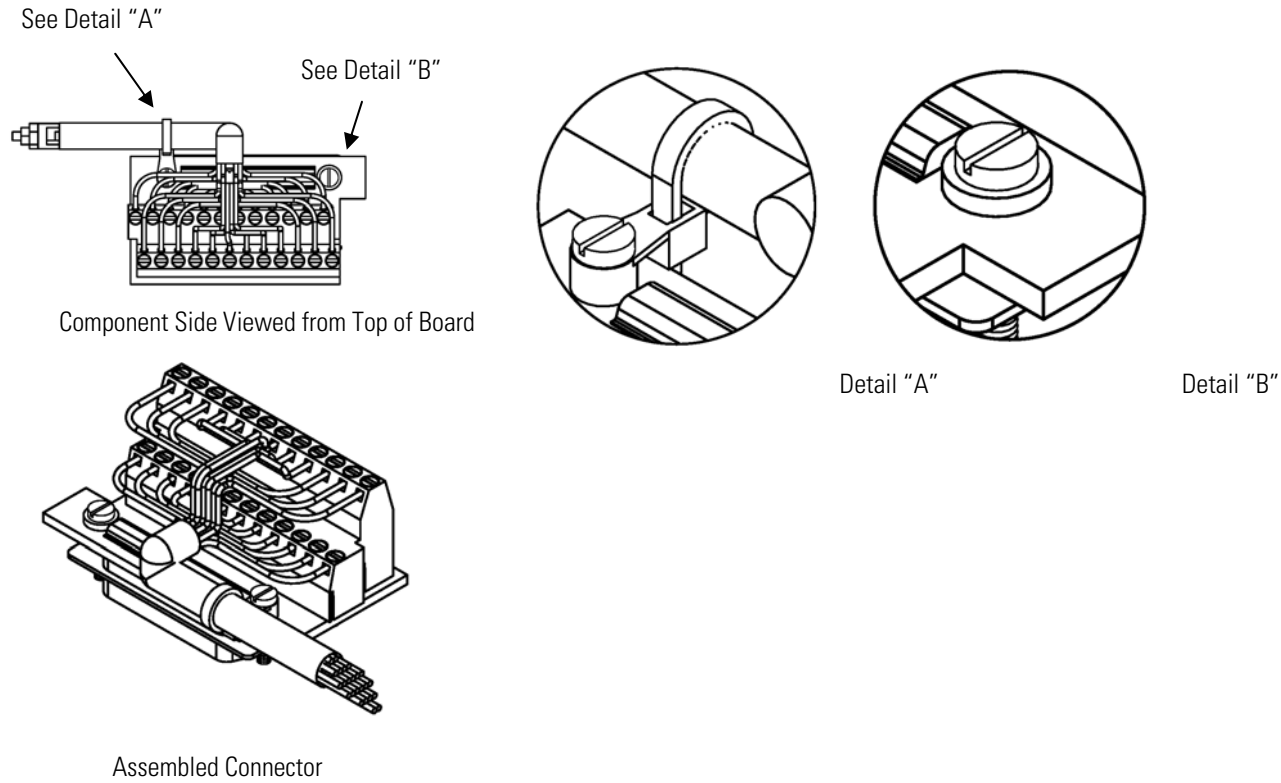
**Table 2–4.** D/O Terminal Board Pin Descriptions

Screw	Signal Description	Screw	Signal Description
1	Relay1_ContactA	13	Relay7_ContactA
2	Relay1_ContactB	14	Relay7_ContactB
3	Relay2_ContactA	15	Relay8_ContactA
4	Relay2_ContactB	16	Relay8_ContactB
5	Relay3_ContactA	17	Relay9_ContactA
6	Relay3_ContactB	18	Relay9_ContactB
7	Relay4_ContactA	19	Relay10_ContactA
8	Relay4_ContactB	20	Relay10_ContactB
9	Relay5_ContactA	21	(not used)
10	Relay5_ContactB	22	+24V
11	Relay6_ContactA	23	(not used)
12	Relay6_ContactB	24	+24V

### 25-Pin Terminal Board

The 25-pin terminal board is included with the optional I/O Expansion Board. [Figure 2–11](#) shows the recommended method for attaching the cable (customer supplied) to the terminal board using the included tie-

down and spacer. [Table 2-5](#) identifies the connector pins and associated signals.



**Figure 2-11.** 25-Pin Terminal Board Views

**Table 2-5.** 25-Pin Terminal Board Pin Descriptions

Screw	Signal Description	Screw	Signal Description
1	IOut1	13	Analog_In1
2	Isolated ground	14	Analog_In2
3	IOut2	15	Analog_In3
4	Isolated ground	16	Ground
5	IOut3	17	Analog_In4
6	Isolated ground	18	Analog_In5
7	IOut4	19	Analog_In6
8	Isolated ground	20	Ground
9	IOut5	21	Analog_In7
10	Isolated ground	22	Analog_In8
11	IOut6	23	Ground
12	Isolated ground	24	Ground



## Power Connections

Before the power is connected, be sure that the front panel power switch is OFF and be sure to verify that the local power matches the label on the back of the analyzer.



**WARNING** The Model 5014*i* is supplied with a three-wire grounded power cord. Under no circumstances should this grounding system be defeated. ▲

## Startup

Use the following procedure when starting the instrument.

1. Turn the power ON and allow 12 hours for the beta detector to stabilize.
2. Although the instrument has been calibrated at the factory, if the instrument has been equilibrated, temperature sensors may be checked. (Assure that the heater is off and that the instrument is sampling room air at a constant temperature for at least 1-2 hours with the cover removed.)
3. After a 12-hour stabilization, the following steps should be performed:
  - a. From the Main Menu, choose **Instrument Controls**. Under Instrument Controls:
    - i. Flow should be set to 16.67 LPM
    - ii. Heater Control should be set to RH with a RH threshold of 50–58%. For lower RH threshold settings, please contact technical support.
    - iii. Filter Tape mass limit should be set to 1,500 µg
    - iv. Filter Tape–Next Time; this should have a start date
    - v. Filter Tape Period should be set to 8 hours for PM<sub>2.5</sub> and PM<sub>10</sub>. U.S. EPA applications may adjust this value as high as 24 hours for PM<sub>10</sub> only. However, 8 hours is recommended for consistent performance.
    - vi. Volumetric Conditions should be set to ACT for both Temp and Press
    - vii. Lrecs and Srecs should be chosen for datalogging and all parameters should be selected in the order they appear from “Concentrations” to “Other Measurements”. Default Lrecs are

set to 60 minute logging with 30% memory and SreCs are 5-minute logging with 70% memory allocated. If there are any changes, be sure to Commit Content.

- b. From the Main Menu, choose Service. Under Service:

**Note** If Service Mode is not displayed, refer to “[Accessing the Service Mode](#)” on page 7-4, then return to the beginning of this step. ▲

- i. Check/Calibrate Ambient Temperature, Sample Temperature, and Flow Temperature
- ii. Check/Calibrate Ambient RH
- iii. Check Calibrate Barometric Pressure Span
- iv. Check/Calibrate Flow Calibration
- v. Perform a Auto Detector Calibration (30 minutes)
- vi. Perform a Mass Foil Calibration (factory calibrated)
- vii. Mass Coefficients are set at the factory.

## Data Content

Please use *i*Port to access data download from the instrument.

## Shutdown

Use the following procedure when shutting down the instrument.

1. Turn the power OFF.
2. Cover instrument ports when not in use.

## Important Tips

### DO NOT

- Do not pressurize the monitor.
- Do not allow liquids to enter the sample port.
- Do not expose the instrument to excessive vibration or magnetic interference.
- Do not remove/adjust the beta attenuation bench of the 5014*i*.
- Do not remove the C-14 radioactive source at any time.

## **DO**

- Operate the instrument in a climate-controlled environment (4–50 °C).
- Set DHCP to ON when changing the IP address.





# Chapter 3

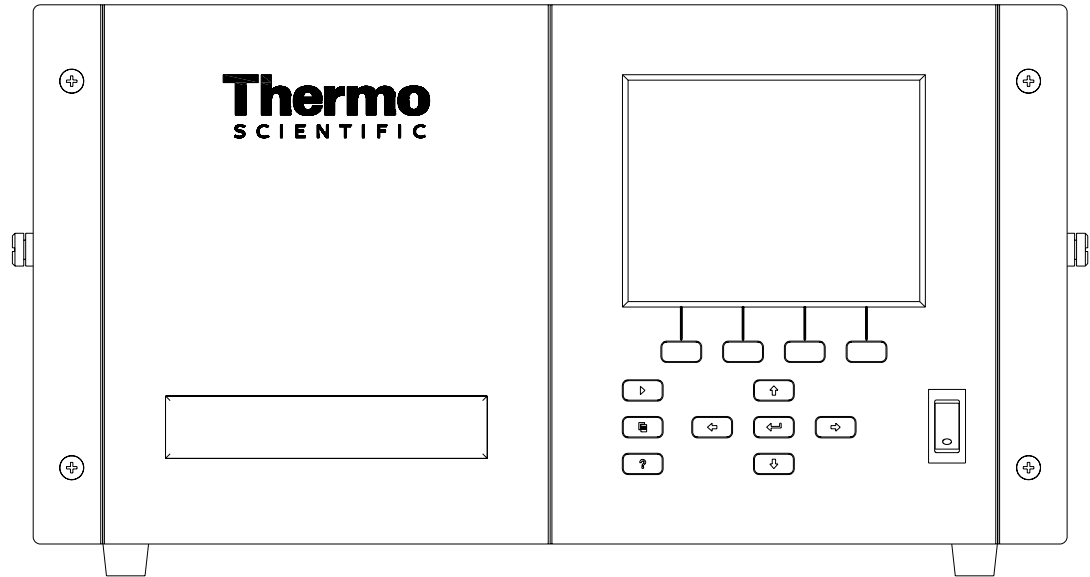
## Operation

This chapter describes the front panel display screens, front panel pushbuttons, and menu-driven firmware. For details, see the following topics:

- “Display” on page 3-1
- “Pushbuttons” on page 3-2
- “Firmware Overview” on page 3-4
- “Range Menu” on page 3-9
- “24-Hour Average” on page 3-13
- “Calibration Factors Menu” on page 3-13
- “Instrument Controls Menu” on page 3-15
- “Diagnostics Menu” on page 3-52
- “Alarms Menu” on page 3-60
- “Service Menu” on page 3-72
- “Password Menu” on page 3-89

### Display

The 320 x 240 pixels graphics liquid-crystal display (LCD) shows the sample concentrations, instrument parameters, instrument controls, help, and error messages. Some menus contain more items than can be displayed at one time. For these menus, use  and  to move the cursor up and down to each item.



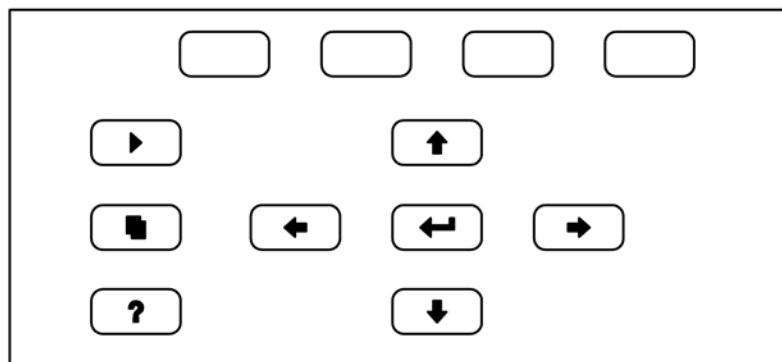
**Figure 3–1.** Front Panel Display



**CAUTION** If the LCD panel breaks, do not let the liquid crystal contact your skin or clothes. If the liquid crystal contacts your skin or clothes, wash it off immediately using soap and water. ▲

## Pushbuttons























The Pushbuttons allow the user to traverse the various screens/menus.



**Figure 3–2.** Front Panel Pushbuttons


Table 3–1 lists the front panel pushbuttons and their functions.

**Table 3–1.** Front Panel Pushbuttons

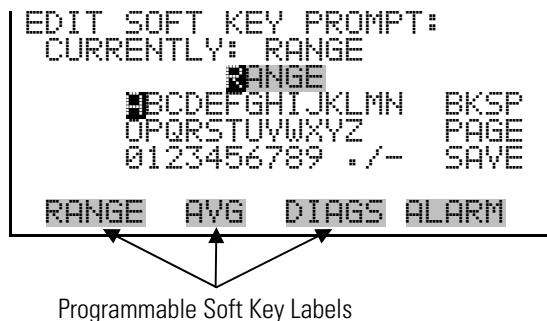
Key Name	Function
 = Soft Keys	The  (soft keys) are used to provide shortcuts that allow the user to jump to user-selectable menu screens. For more information on processing soft keys, see “Soft Keys” below.
 = Run	The  is used to display the Run screen. The Run screen normally displays the current PM concentrations, but also has additional Run screens for ambient conditions, sample conditions, and mass sensor data. Press  and  to scroll through the different Run screens.
 = Menu	The  is used to display the Main Menu when in the Run screen, or back up one level in the menu system. For more information about the Main Menu, see “Main Menu” later in this chapter.
 = Help	The  is context-sensitive, that is, it provides additional information about the screen that is being displayed. Press  for a brief explanation about the current screen or menu. Help messages are displayed using lower case letters to easily distinguish them from the operating screens. Press  to return to the Run screen, or any other key to exit a help screen.
  = Up, Down   = Left, Right	The four arrow pushbuttons (  ,  ,  , and  ) move the cursor up, down, left, and right or change values and states in specific screens.
 = Enter	The  is used to select a menu item, accept/set/save a change, and/or toggle on/off functions.

## Soft Keys

The soft keys are multi-functional keys that use part of the display to identify their function. The function of the soft keys is to provide a shortcut to the most often used menus and screens. They are located directly underneath the display, and user-defined labels in the lower part of the display indicate the function of each key at that time.

To change a soft key, place the menu cursor “>” on the item of the selected menu or screen you wish to set. Press  followed by the selected soft key within 1 second of pressing the right-arrow key. The “edit soft key prompt” will be displayed for configuration of the new label.

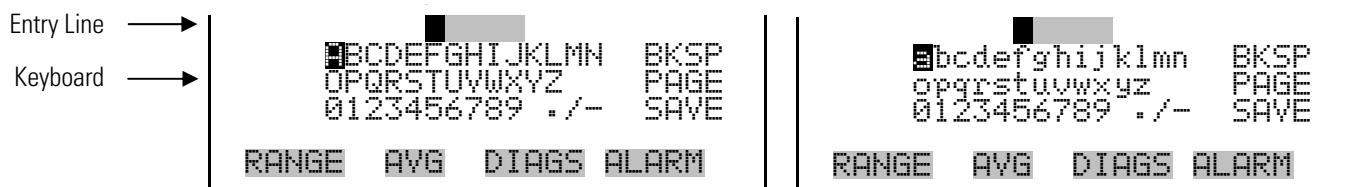
**Note** Not all menu items may be assigned to soft keys. If a particular menu or screen item cannot be assigned, the key assignment screen will not come up upon entering right-arrow-soft key combinations. All items under the Service menu (including the menu itself) cannot be assigned soft keys. ▲



## Alphanumeric Entry Screen

The alphanumeric entry screen is used to enter strings consisting of letters, numbers, and other characters. The cursor may be positioned within the entry line using the and keys. If a character is entered over an existing character, that character will be overwritten. Use the and keys to switch between the entry line and the keyboard as well as to move within the keyboard. To select a character to add to the string, use the cursor keys to position the cursor over the desired character, and then press the key to add that character to the entry line.

On the right side of the keyboard are special functions. BKSP is used to move the cursor in the entry line one place to the left, deleting the character that was to the left of the cursor and moving any character at or to the right of the cursor one place to the left. PAGE is used to change the keyboard character page. For the English language, this switches between upper and lower-case alphabetic characters. SAVE stores the string from the entry line into the parameter. Alternately, if the active cursor is moved to the entry line, may be pressed to store the string from the entry line into the parameter.



## Firmware Overview

The Model 5014*i* utilizes the menu-driven firmware as illustrated by the flowchart in [Figure 3–3](#). The Power-Up screen, shown at the top of the flowchart, is displayed each time the instrument is turned on. This screen is displayed while the instrument is warming up and performing self-checks. After the warm-up period, the Run screen is automatically displayed. The Run screen normally displays the current PM concentrations, but also has additional Run screens for ambient conditions, sample conditions, and mass sensor data. From the Run screen, the Main Menu can be displayed by pressing . The Main Menu contains a list of submenus. Each



submenu contains related instrument settings. This chapter describes each submenu and screen in detail. Refer to the appropriate sections for more information.

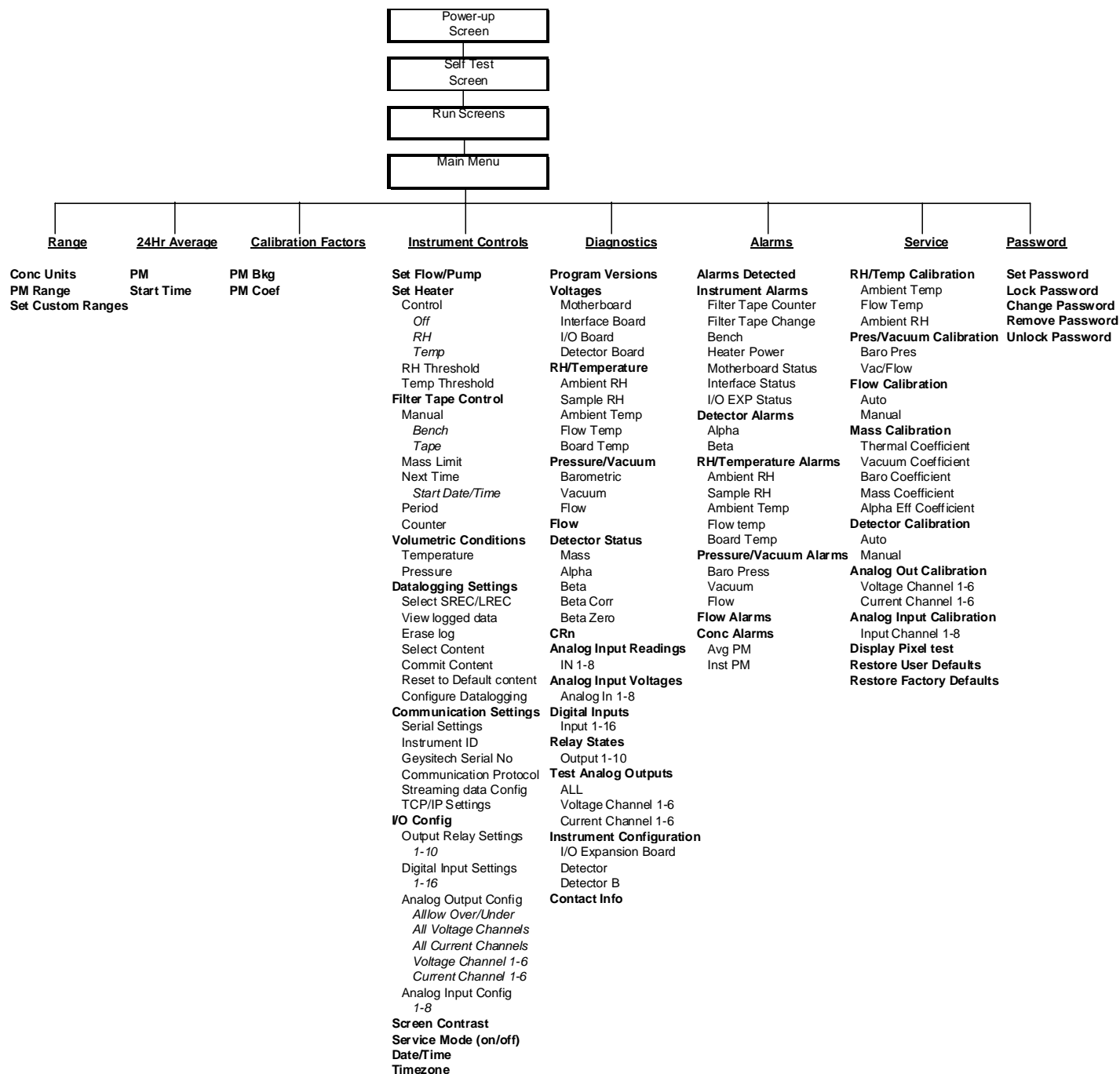


Figure 3–3. Flowchart of Menu-Driven Firmware

## Power-Up Screen

The Power-Up screen is displayed when power is applied to the Model 5014*i*. This screen is displayed while the internal components are warming up and diagnostic checks are being performed.



## Run Screens

The Run screens display the PM concentration, ambient conditions, sample conditions, and mass sensor data. The status bar displays the time (24-hour format), the password (lock) icon, service (wrench) icon, alarm (bell) icon, and optional zero/span sample solenoid valve status, if installed.



### Status Bar Icons

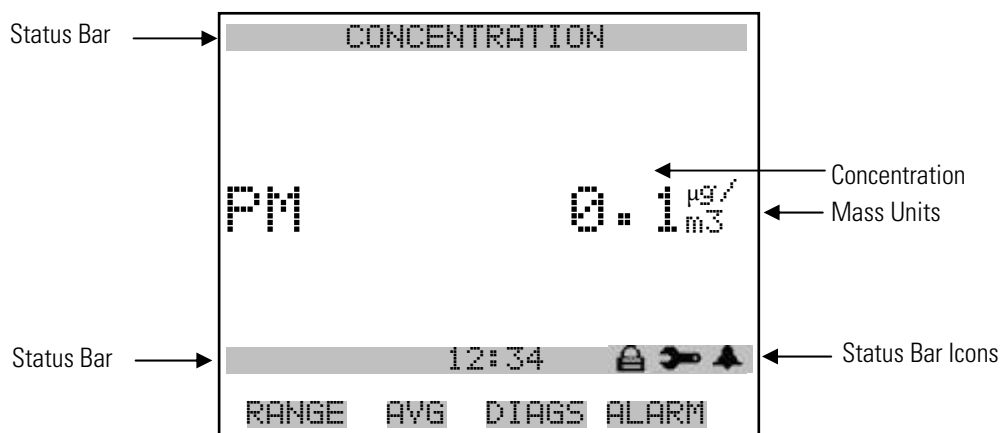
The password (lock) icon indicates that no parameter changes can be made from the front panel.



The alarm (bell) icon indicates that an alarm is active.

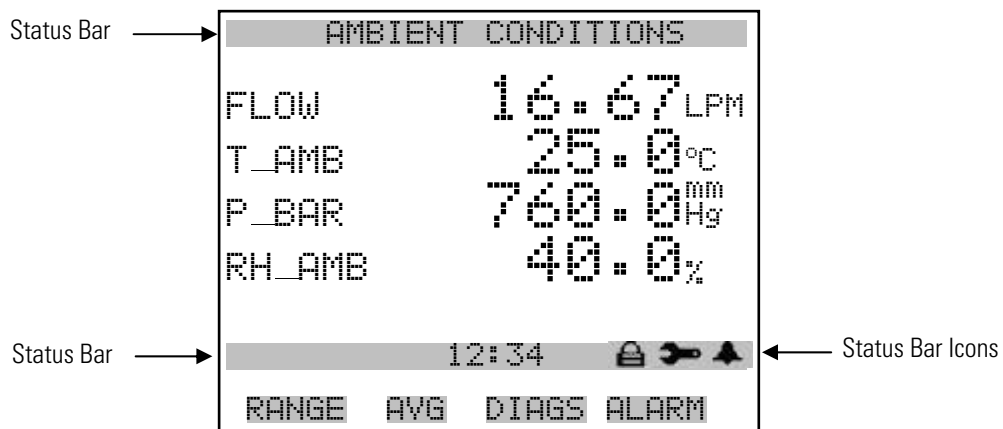
The service (wrench) icon indicates that the instrument is in the service mode.

The Run screen normally displays the current particulate matter (PM) concentrations, but also has additional Run screens for ambient conditions, sample conditions, and mass sensor data. Pressing  and  will scroll through the different Run screens.



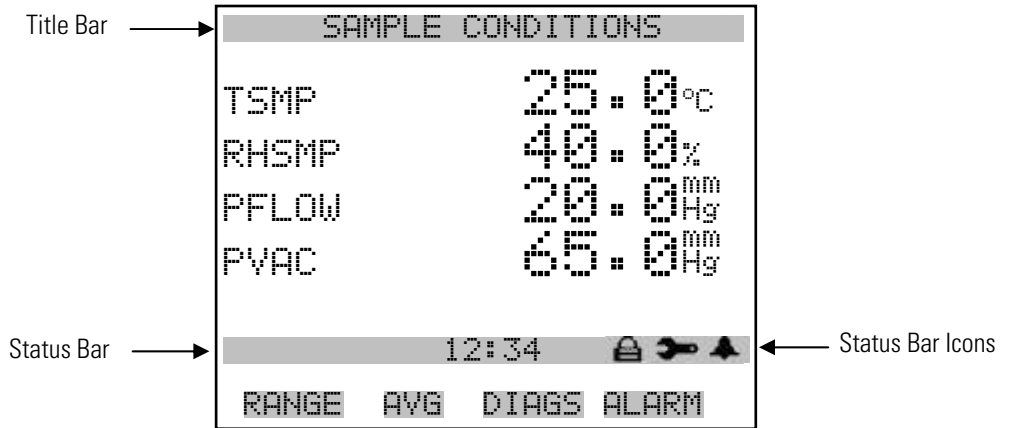
### Ambient Conditions Run Screen

The Ambient Conditions Run screen displays the real-time volumetric flow rate at the inlet, the ambient temperature, the barometric pressure, and the ambient relative humidity.



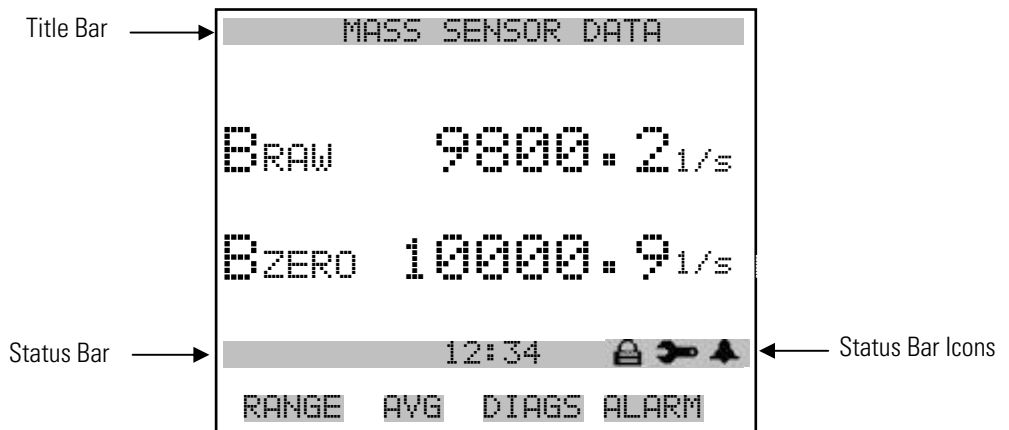
**Sample Conditions Run Screen**

The Ambient Conditions Run screen displays the sample filter temperature, the sample filter relative humidity, the differential pressure across the orifice, and the vacuum under the filter tape.








**Mass Sensor Data Run Screen**

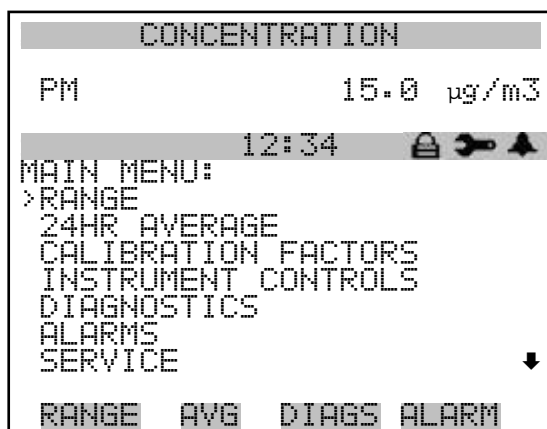
The Mass Sensor Data Run screen displays the real-time beta counts during attenuation and the initial beta counts from a fresh filter spot.



## Main Menu

The Main Menu contains a number of submenus. Instrument parameters and settings can be read and modified within the submenus according to their function. The concentration appears above the Main Menu and submenus in every screen. The Service menu is visible only when the instrument is in service mode. For more information on the service mode, see “Service Mode” later in this chapter.

- Use  and  to move the cursor up and down.
- Press  to make a selection.
- Press  to return to the Main Menu or  to return to the Run screen.



PASSWORD

## Range Menu

The Range menu allows the operator to select the concentration units, PM standard ranges, and to set the custom ranges.

- In the Main Menu, choose **Range**



## Concentration Units

The Concentration Units screen defines how the particles concentration readings are expressed. Concentration units of micrograms per cubic meter ( $\mu\text{g}/\text{m}^3$ ) and milligrams per cubic meter ( $\text{mg}/\text{m}^3$ ) are available.

When switching the selected units, the instrument's analog ranges all default to the highest range. For example, when switching from  $\text{mg}/\text{m}^3$  to  $\mu\text{g}/\text{m}^3$ , the ranges default to  $10000 \mu\text{g}/\text{m}^3$ . Therefore, whenever you change units, you should also check the range settings.

**Note** If the units change, the instrument should be re-calibrated. A display warning will appear. ▲

- In the Main Menu, choose Range > **Conc Units**.

```
CONC UNITS:
CURRENTLY:      mg/m3
SET TO:         µg/m3 ?

↑↓ CHANGE VALUE  ← SAVE

RANGE  AVG  DIAGS  ALARM
```

## Range

The Range screen defines the concentration range of the analog outputs. For example, a PM range of 0–100  $\mu\text{g}/\text{m}^3$  sets the analog output to concentrations between 0 and 100  $\mu\text{g}/\text{m}^3$  by default.

The display shows the current PM range. The next line of the display is used to change the range.

Table 3–2 lists the standard ranges.

- In the Main Menu, choose Range > **Range**.

```
PM RANGE:
CURRENTLY:      100.0
SET TO:         1000 ?

      ↑↓ CHANGE VALUE
      ← SAVE VALUE

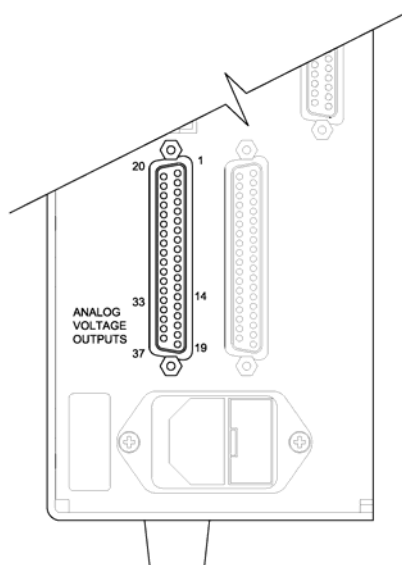
RANGE  AVG  DIAGS  ALARM
```

**Table 3–2.** Standard Ranges

mg/m <sup>3</sup>	µg/m <sup>3</sup>
0.1	100
1.0	1000
2.0	2000
3.0	3000
5.0	5000
10.00	10000
C1	C1
C2	C2
C3	C3

C1, C2, and C3 are custom ranges. For more information about custom ranges, see “Set Custom Ranges” below.

The analog outputs are arranged on the rear panel connector as shown in [Figure 3–4](#). See [Table 3–3](#) for channels and pin connections.



**Figure 3–4.** Pin-Out of Rear Panel Connector

**Table 3–3.** Default Analog Outputs

Channel	Connector Pin	I/O Terminal Pin	Description
1	14	1	PM
2	33	3	AVG PM
3	15	5	Flow
4	34	7	Ambient Temperature
5	17	9	Flow Temperature
6	36	11	Ambient Relative Humidity
Ground	16, 18, 19, 35, 37	2, 4, 6, 8, 10, 12	Signal Ground

**Note** All channels are user definable. If any customization has been made to the analog output configuration, the default selections may not apply. ▲

## Set Custom Ranges

The Set Custom Ranges menu lists three custom ranges, which are user-defined. In the  $\text{mg}/\text{m}^3$  mode, any value between  $0.1 \text{ mg}/\text{m}^3$  and  $10.00 \text{ mg}/\text{m}^3$  can be specified as a range. In the  $\mu\text{g}/\text{m}^3$  mode, any value between  $100 \mu\text{g}/\text{m}^3$  and  $10000 \mu\text{g}/\text{m}^3$  can be specified as a range.

- In the Main Menu, choose Range > **Set Custom Ranges**.

```
CUSTOM RANGES:
>CUSTOM RANGE 1      555.6
CUSTOM RANGE 2      1875.0
CUSTOM RANGE 3      8125.0

RANGE  AVG  DIAGS  ALARM
```

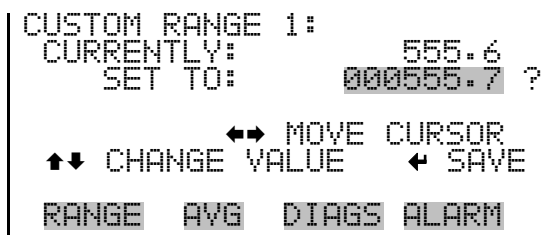
## Custom Ranges

The Custom Ranges screen is used to define the custom ranges.

The display shows the current custom range. The next line of the display is used to set the range. For more information about selecting ranges, see “Range” above.

- In the Main Menu, choose Range > Set Custom Ranges > **Custom Range 1, 2, or 3**.

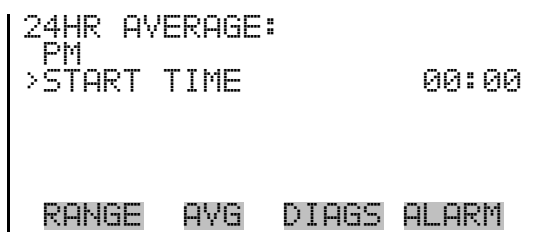




## 24-Hour Average

The 24-Hour Average screen defines a start time during which concentration measurement is averaged over a daily 24-hours period. The average concentration of the primary readings are calculated for that time period and averaged out. A new 24-hour average concentration is displayed once per day. The display shows the current 24-hour average PM concentration. The next line of the display is used to change the 24-hour averaging time.

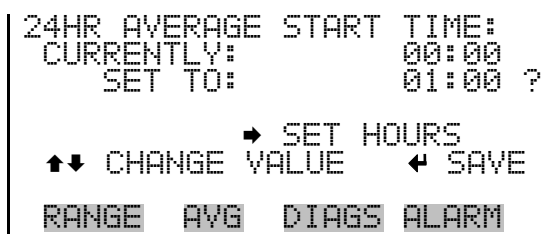
- In the Main Menu, choose **24HR Averages**.



## 24-Hour Average Start Time

The 24-Hour Average Start Time screen allows the user to adjust the 24-hour averaging start time.

- In the Main Menu, choose 24HR Averages > **Avg Time**.



## Calibration Factors Menu

Calibration factors are determined during automatic and manual calibration and are used to correct the concentration readings. The Calibration Factors menu displays the calibration factors as shown below. The instrument can also be calibrated manually using this menu. For more information about calibration, see Chapter 4, “[Calibration](#)”.

The calibration factors for the PM BKG (offset) and PM COEF (slope) are set to 0.0 and 1.0 by default. Should regional settings require an adjustment to these values that DO NOT compromise regulatory approvals for this instrument, those values can be adjusted at this point.

- In the Main Menu, choose **Calibration Factors**.

```
CALIBRATION FACTORS:
>PM BKG           0.0
PM COEF          1.000

RANGE  AVG  DIAGS  ALARM
```

### **PM Background**

The PM Background screen allows the user to manually adjust the PM Intercept. The PM concentration based on the SET BKG TO is displayed to facilitate the setting. The PM concentration displayed in the Run portion of the screen is NOT affected by the SET BKG until the value is saved.

- In the Main Menu, choose Calibration Factors > **PM Bkg**.

```
PM BACKGROUND:
CURRENTLY:       0.0
SET TO:         0.0 ?

      ←→ MOVE CURSOR
↑↓ CHANGE VALUE  ← SAVE

RANGE  AVG  DIAGS  ALARM
```

### **PM Coefficient**

The PM Coefficient screen allows the user to manually adjust the PM coefficient. The PM concentration based on the SET COEF TO is displayed to facilitate setting. The PM concentration displayed in the Run portion of the screen is NOT affected by the SET COEF until the value is saved.

- In the Main Menu, choose Calibration Factors > **PM Coef**.

```

PM COEFFICIENT:
CURRENTLY:      1.000
SET TO:        1.00 ?

      ←→ MOVE CURSOR
↑↓ CHANGE VALUE  ← SAVE

RANGE  AVG  DIAGS  ALARM
  
```

## Instrument Controls Menu

The Instrument Controls menu contains a number of items that may be selected to control various instrument operational parameters. The firmware controls listed in this menu enable control of the listed instrument functions.

- In the Main Menu, choose **Instrument Controls**.

```

INSTRUMENT CONTROLS:
>SET FLOW/PUMP
SET HEATER
FILTER TAPE CONTROL
VOLUMETRIC CONDITIONS
DATA LOGGING SETTINGS ↓

RANGE  AVG  DIAGS  ALARM
  
```

```

COMMUNICATION SETTINGS
I/O CONFIGURATION
SCREEN CONTRAST
SERVICE MODE
DATE/TIME
TIMEZONE
  
```

### Set Flow/Pump

The Set Flow/Pump menu allows the user to manually adjust the flow values, and to change the operating state of the pump to ON or OFF.

- In the Main Menu, choose Instrument Controls > **Set Flow/Pump**.

```

FLOW/PUMP:
>FLOW      16.67
PUMP       ON

RANGE  AVG  DIAGS  ALARM
  
```

**Flow** The Flow screen is used to view and adjust the flow.

- In the Main Menu, choose Instrument Controls > Set Flow/Pump > **Flow**.

## Operation

### Instrument Controls Menu

```
FLOW:
CURRENTLY:      16.67 LPM
SET TO:         16.67 LPM?
                ↑↓ INC/DEC
                ← SAVE VALUE
RANGE  AVG  DIAGS  ALARM
```

**Pump** The Pump screen allows the user to toggle the pump to either ON or OFF.

- In the Main Menu, choose Instrument Controls > Set Flow/Pump > **Pump**.

```
PUMP:
CURRENTLY:      ON
SET TO:         OFF ?
                ← TOGGLE VALUE
RANGE  AVG  DIAGS  ALARM
```

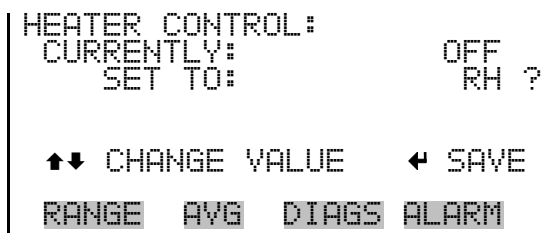
**Set Heater** The Set Heater menu allows the user to set the status of the heater, RH threshold, and temperature threshold in various modes.

- In the Main Menu, choose Instrument Controls > **Set Heater**.

```
HEATER:
>CONTROL
RH THRESHOLD    40 %
TEMP THRESHOLD  30 °C
RANGE  AVG  DIAGS  ALARM
```

**Control** The Control screen is used to set the status of the heater to either ON/OFF, RH threshold, or TEMP threshold.

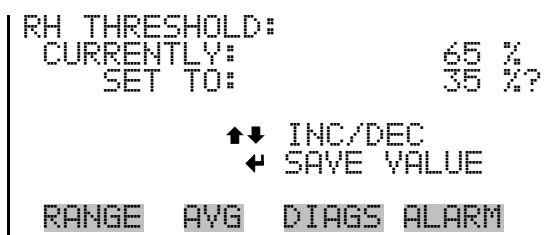
- In the Main Menu, choose Instrument Controls > Set Heater > **Control**.



### RH Threshold

The RH Threshold screen is used to change the RH threshold value in percent. The RH threshold is typically compatible with the gravimetric method being used for comparison.

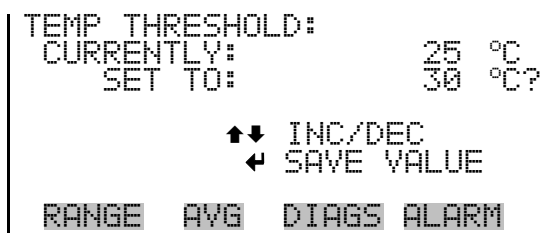
- In the Main Menu, choose Instrument Controls > Set Heater > **RH Threshold**.



### Temperature Threshold

The Temperature Threshold screen is used to change the temperature threshold value.

- In the Main Menu, choose Instrument Controls > Set Heater > **Temp Threshold**.



### Filter Tape Control

The Filter Tape Control menu allows the user to manually move or set the next time period for tape control.

- In the Main Menu, choose Instrument Controls > **Filter Tape Control**.

## Operation

### Instrument Controls Menu

```
FILTER TAPE CONTROL:
>MANUAL
MASS LIMIT          1,500 µg
NEXT TIME          05MAY08 00:00
PERIOD              8 HRS
COUNTER            0

RANGE  AVG  DIAGS  ALARM
```

**Manual** The Manual screen allows the user to move or stop the filter tape and open or close the measurement bench.

- In the Main Menu, choose Instrument Controls > Filter Tape Control > **Manual**.

```
MANUAL:
>BENCH(S)          CLOSED
TAPE                STOP

← TOGGLE VALUE

RANGE  AVG  DIAGS  ALARM
```

**Mass Limit** The Mass Limit screen allows the user to set the mass limit. The default is 1,500 µg (or 1.5 mg) and is specified as part of any U.S. EPA and TUV approvals. However, the limit can be increased as much as 5,000 µg for non-regulatory monitoring.

- In the Main Menu, choose Instrument Controls > Filter Tape Control > **Mass Limit**.

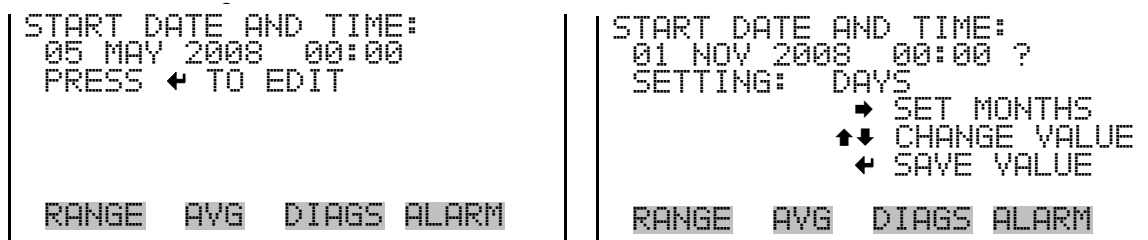
```
MASS LIMIT:
CURRENTLY:          1500
SET TO:             1500 ?

←↑↓ CHANGE VALUE  ↔ MOVE CURSOR  ← SAVE

RANGE  AVG  DIAGS  ALARM
```

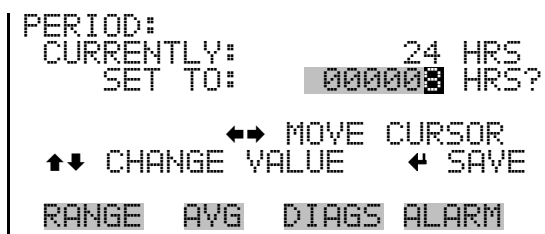
**Next Time** The Next Time screen is used to view and set the initial date and time (24-hour format) for the next filter tape change.

- In the Main Menu, choose Instrument Controls > Filter Tape Control > **Next Time**.



**Period** The Period screen allows the user to set the period. The next filter tape change would be scheduled after the number of hours the period is set for. The official tape change for TUV and U.S. EPA for PM<sub>2.5</sub> and PM<sub>10</sub> is set for 8 hours.

- In the Main Menu, choose Instrument Controls > Filter Tape Control > **Period**.



**Counter** The Counter screen allows the user to record the current filter tape count and reset the tape count to zero.

- In the Main Menu, choose Instrument Controls > Filter Tape Control > **Counter**.



## Volumetric Conditions

The Volumetric Conditions menu allows the user to turn temperature/pressure compensation on and off and to set the standard pressure and temperature values in various modes.

## Operation

### Instrument Controls Menu


- In the Main Menu, choose Instrument Controls > **Volumetric Conditions**.

```
VOLUMETRIC CONDITIONS:
>TEMPERATURE          ACT
PRESSURE              STD

RANGE  AVG  DIAGS  ALARM
```

### Temperature Compensation

The Temperature screen is used to turn the temperature correction to actual or standard.

- Press  to toggle and set the temperature compensation to actual or standard.

```
TEMPERATURE:
>COMPENSATION          ACT
STANDARD              25 °C

RANGE  AVG  DIAGS  ALARM
```

### Standard Temperature

The Standard Temperature screen is used to set the standard temperature.

- In the Main Menu, choose Instrument Controls > Volumetric Conditions > Temperature > **Standard**.


```
STANDARD TEMPERATURE:
CURRENTLY:             25 °C
SET TO:                0.0 °C ?

  ↑↓ INC/DEC
  ← SAVE VALUE

RANGE  AVG  DIAGS  ALARM
```

### Pressure Compensation

The Pressure Compensation screen is used to turn the pressure correction to actual or standard.

- Press  to toggle and set the pressure compensation to actual or standard.



```

PRESSURE:
>COMPENSATION  760 mmHg
STANDARD      760 mmHg

RANGE  AVG  DIAGS  ALARM
  
```

**Standard Pressure** The Standard Pressure screen is used to set the standard pressure.

- In the Main Menu, choose Instrument Controls > Volumetric Conditions > Pressure > **Standard**.

```

STANDARD PRESSURE:
CURRENTLY:          ACT
SET TO:            760 mmHg ?

  ↑↓ INC/DEC
  ← SAVE VALUE

RANGE  AVG  DIAGS  ALARM
  
```

## Datalogging Settings

The *i*Series instruments include a built-in datalogging capability as a standard feature. The operator is allowed to create two different types of records, which for historical reasons, are named lrecs and srecs. Each record can contain up to 32 different fields, or data items, and records can be created at user-defined intervals ranging from 1 to 60 minutes.

Record generation is tied to the instrument's real-time clock. For example, if the logging period for srecs is set to 30 minutes, a new srec will be generated on every hour and every half hour (10:00, 10:30, 11:00 ...). Lrecs and srecs function independent of each other. So, for example, an srec containing just the current PM level could be generated every 5 minutes while an lrec containing a full set of diagnostic data could be generated once every hour.

The analyzer's computer system includes three megabytes of flash memory which is enough to store a full lrec containing 32 data items and a full srec containing 32 items once each minute for a week (>20,000 total records). If logging is limited to the minimum content of date, time, PM concentration and error flags, the analyzer can store data once each minute for 4 months (>190,000 total records).

The Datalogging Settings menu allows the user flexibility in how data is stored and recorded.

## Operation

### Instrument Controls Menu

- In the Main Menu, choose Instrument Controls > **Datalogging Settings**.

```
DATALOGGING:
>SELECT SREC/LREC      SREC
VIEW LOGGED DATA
ERASE LOG
SELECT CONTENT
COMMIT CONTENT        ↓
RANGE  AVG  DIAGS  ALARM

RESET TO DEFAULT CONTENT
CONFIGURE DATALOGGING
```

### Select Srec/Lrec

The Select Srec/Lrec screen is used to select the log record type for other operations in this menu.

- In the Main Menu, choose Instrument Controls > Datalogging Settings > **Select Srec/Lrec**.

```
SELECT LOG TYPE:
CURRENTLY:          SREC
SET TO:             LREC ?
                    ← TOGGLE VALUE
RANGE  AVG  DIAGS  ALARM
```

### View Logged Data

The View Logged Data screen is used to select the starting point to view the logged data by the number of records or by date and time. Note that both types of records cannot be viewed at the same time, only the selected record type.

- In the Main Menu, choose Instrument Controls > Datalogging Settings > **View Logged Data**.

```
SELECT START POINT BY:
SET TO: # OF RECS
        ↑↓ CHANGE    ← ACCEPT
RANGE  AVG  DIAGS  ALARM
```

### Number of Records

The Number of Records screen is used to select the number of records to view, ending with the most recent. It also shows the total number of records that have been logged for the selected record type.

```

SET # BACK FROM CURRENT:
TOTAL LRECS:          000000
                      20

      ←→ MOVE CURSOR
↑↓ CHANGE VALUE      ← SAVE

RANGE  AVG  DIAGS  ALARM
  
```

The Record Display screen (read only) displays the selected records.

```

time    date    flags
10:01  01/20/07  8105151
10:02  01/20/07  8105151
10:03  01/20/07  8105151
10:04  01/20/07  8105151
      ↑↓ PGUP/DN  ←→ PAN L/R

RANGE  AVG  DIAGS  ALARM
  
```

### Date and Time

The Date and Time screen is used to set a start date and time for which to view logged data. For example, if “20 Jan 2007 10:00” is entered, then the first logged data record that is displayed is the first record after this time. If set to one minute logging, this would be at “20 Jan 2007 10:01”.

```

DATE AND TIME:
20 JAN 2007 10:00
      ↑↓ CHG  DAYS
      → SET CURSOR TO MONTHS
      ← ACCEPT AS SHOWN

RANGE  AVG  DIAGS  ALARM
  
```

The Record Display screen (read only) displays the selected records.

## Operation

### Instrument Controls Menu

```
time    date    flags
10:01  01/20/07  8105151
10:02  01/20/07  8105151
10:03  01/20/07  8105151
10:04  01/20/07  8105151
  ↑↓ PGUP/DN  ←→ PAN L/R
RANGE  AVG  DIAGS  ALARM
```

**Erase Log** The Erase Log screen is used to erase all saved data for the selected record type only (not both srecs and lrecs).

- In the Main Menu, choose Instrument Controls > Datalogging Settings > **Erase Log**.

```
ERASE LREC LOG FILE DATA?
                               ← ERASE
RANGE  AVG  DIAGS  ALARM
```

```
ERASE LREC LOG FILE DATA?
                               ← ERASE
ARE YOU SURE YOU WANT TO?
PRESS → TO CONFIRM ERASURE
RANGE  AVG  DIAGS  ALARM
```

**Select Content** The Select Content submenu displays a list of 32 record fields to use to configure the data to be logged. When a field is selected, a submenu list appears of the items to choose from to assign to those fields. Item types are Concentrations, Other Measurements, and Analog Inputs (if the I/O expansion board is installed). These record fields comprise a temporary list of items for the selected record type that must be committed via the datalogging menu before the changes will apply. Note that committing any changes to this list will erase all currently logged data for the selected record type only, as the format of the stored data is changed.

- In the Main Menu, choose Instrument Controls > Datalogging Settings > **Select Content**.

```
LREC FIELDS:
>FIELD 1          PM
FIELD 2          AVG PM
FIELD 3          FLOW VOL
FIELD 4          AMB RH
FIELD 5          BARO PRESS ↓
RANGE  AVG  DIAGS  ALARM
```

### Choose Field Data

The Choose Field Data submenu displays a list of the types of data that can be logged for the current field. Choices are Concentrations, Other Measurements, and Analog Inputs (if the I/O expansion board is installed).


- In the Main Menu, choose Instrument Controls > Datalogging Settings > Select Content > **Field 1–32**.

```

DATA IN SREC FIELD  1:
>CONCENTRATIONS
OTHER MEASUREMENTS
ANALOG INPUTS

RANGE  AVG  DIAGS  ALARM
  
```

### Concentrations

The Concentrations screen allows the user to assign one of the concentrations to the selected record field. The currently selected item is shown by “<--” after it. Note that at this point, pressing  indicates that these are proposed changes as opposed to implemented changes. To change the selected record format and erase record log file data, see “Commit Content” below. The display shows the current heater for the mode selected (PM).


- In the Main Menu, choose Instrument Controls > Datalogging Settings > Select Content > select Field > **Concentrations**.

```

CONCENTRATIONS:
>NONE
PM
AVG PM
<--

RANGE  AVG  DIAGS  ALARM
  
```

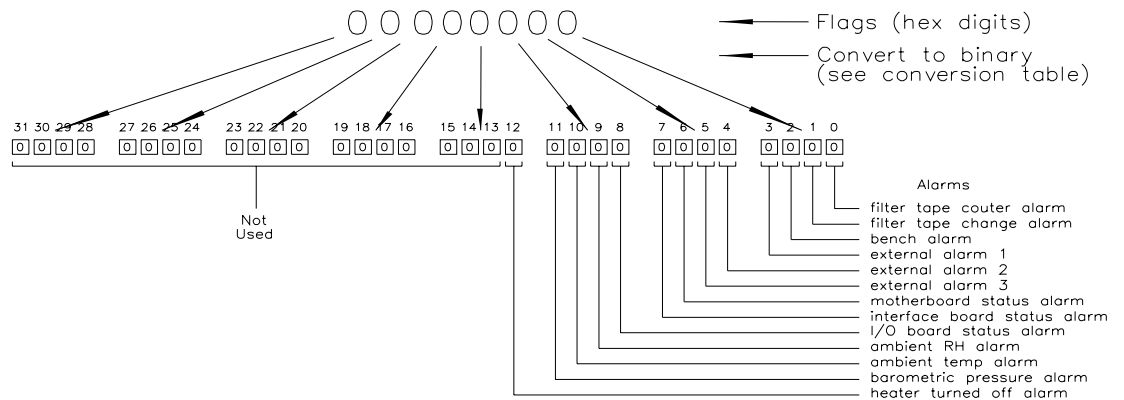
### Other Measurements

The Other Measurements screen allows the user to assign one of the other available measurement types to the selected record field. The currently selected item is shown by “<--” after it. Items displayed are determined by the options installed. For Common Flags and Detector A Flags, see [Figure 3–5](#) and [Figure 3–6](#) for data descriptions. Note that at this point, pressing  indicates that these are proposed changes as opposed to implemented changes. To change the selected record format and erase record log file data, see “Commit Content” below.

- In the Main Menu, choose Instrument Controls > Datalogging Settings > Select Content > select Field > **Other Measurements.**

```
OTHER MEASUREMENTS:
>NONE
BARO PRES
VACUUM
FLOW PRES
AMB RH
↓
RANGE  AVG  DIAGS  ALARM
```

```
SAMP RH
AMB TEMP
BRD TEMP
FLOW TEMP
FLOW VOL
BETA
BETA RAW
ALPHA RAW
MASS
BETA ZERO
EXT ALARMS
BETA REF
COMMON FLAGS
DET A FLAGS
MASSCMP
```



Hex to Binary Conversion Table	
0 = 0000	8 = 1000
1 = 0001	9 = 1001
2 = 0010	A = 1010
3 = 0011	B = 1011
4 = 0100	C = 1100
5 = 0101	D = 1101
6 = 0110	E = 1110
7 = 0111	F = 1111

Alarm Status  
0 = no alarm  
1 = alarm

FLAG STATUS - 5014i/5030i  
Common Alarms / Extra Common Flags  
LOGO TRANSLATOR  
REV. A

**Figure 3-5.** Common Flags

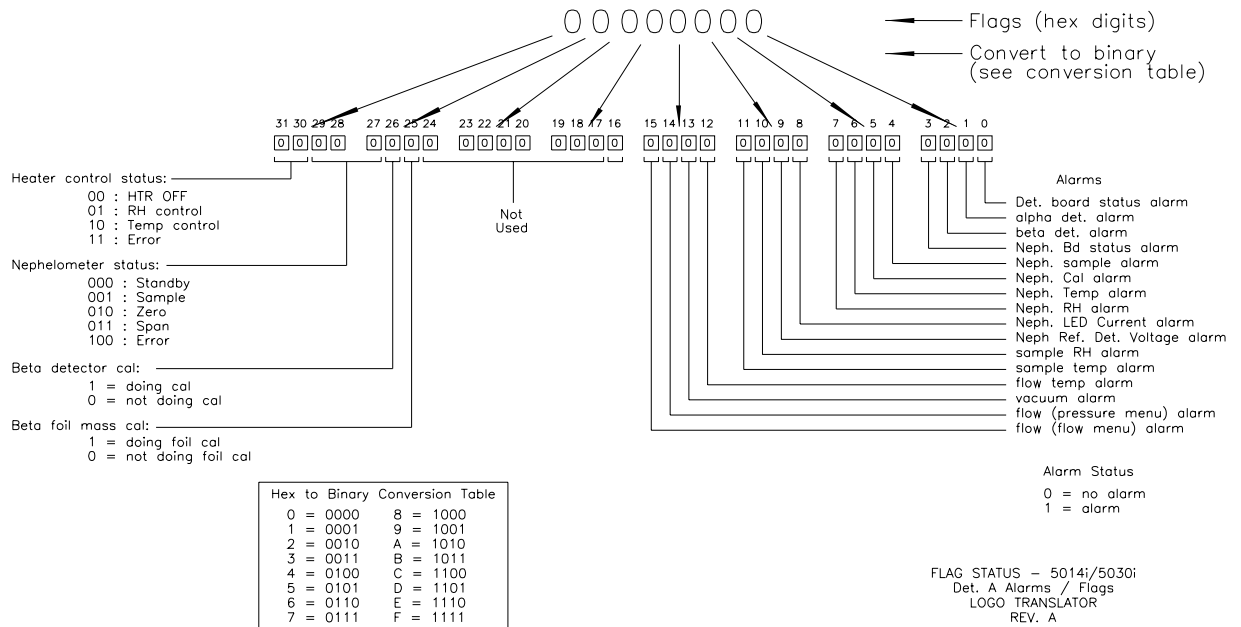


Figure 3–6. Detector A Flags

### Analog Inputs

The Analog Inputs screen allows the user to select the parameter (none or analog inputs 1–8) to the selected record field. The selected item is shown by “<--” after it. Note that at this point, pressing indicates that these are proposed changes as opposed to implemented changes. To change the selected record format and erase record log file data, see “Commit Content” below.

- In the Main Menu, choose Instrument Controls > Datalogging Settings > Select Content > select Field > **Analog Inputs**.

```

ANALOG INPUTS:
>NONE
ANALOG IN 1
ANALOG IN 2
ANALOG IN 3
ANALOG IN 4
↓
RANGE  AVG  DIAGS  ALARM
    
```

### Commit Content

The Commit Content screen is used to save any changes that have been made to any of the record fields for the selected record type. Saving changes will erase record log file data for that record type. If no changes have been made “NO CHANGES TO RECORD LIST!” will appear. For more information about selecting the content of logged data fields, see “[Select Content](#)” above.

- In the Main Menu, choose Instrument Controls > Datalogging Settings > **Commit Content**.

```
CHANGE LREC DATA AND  
ERASE LREC LOG FILE DATA?  
          ← COMMIT  
  
RANGE  AVG  DIAGS  ALARM
```

```
CHANGE LREC DATA AND  
ERASE LREC LOG FILE DATA?  
          ← COMMIT  
ARE YOU SURE YOU WANT TO?  
PRESS → TO CONFIRM ERASURE  
  
RANGE  AVG  DIAGS  ALARM
```

### Reset to Default Content

The Reset to Default Content screen is used to reset all of the datalogging record field items to default values for the selected record type. For more information about selecting the content of logged data fields, see “[Select Content](#)” above.

- In the Main Menu, choose Instrument Controls > Datalogging Settings > **Reset to Default Content**.

```
RESET LREC DATA AND  
ERASE LREC LOG FILE DATA?  
          ← RESET  
  
RANGE  AVG  DIAGS  ALARM
```

```
RESET LREC DATA AND  
ERASE LREC LOG FILE DATA?  
          ← RESET  
ARE YOU SURE YOU WANT TO?  
PRESS → TO CONFIRM RESET  
  
RANGE  AVG  DIAGS  ALARM
```

### Configure Datalogging

The Configure Datalogging menu deals with datalogging configuration for the currently selected record type.

- In the Main Menu, choose Instrument Controls > Datalogging Settings > **Configure Datalogging**.



```

DATALOGGING SETTINGS:
>LOGGING PERIOD MIN      60
MEMORY ALLOCATION %      50
DATA TREATMENT          AVG
FLAG STATUS DATA       ON

RANGE  AVG  DIAGS  ALARM
  
```

### Logging Period Min

The Logging Period Min screen is used to select the logging period in minutes for the selected record format (srec or lrec). List of choices include: off, 1, 5, 15, 30, and 60 minutes (default).

- In the Main Menu, choose Instrument Controls > Datalogging Settings > Configure Datalogging > **Logging Period Min**.

```

SET PERIOD FOR SREC:
CURRENTLY:           5 MIN
SET TO:              OFF ?

↑↓ CHANGE VALUE    ← SAVE

RANGE  AVG  DIAGS  ALARM
  
```

### Memory Allocation Percent

The Memory Allocation Percent screen is used to select the percentage of total memory that may be used by the selected record type (lrecs or srecs). Percentages between 0 and 100% are available in increments of 10. Changing this value results in log erasure for both types of records, and changing the percent allocated to one record type will automatically change the other.

- In the Main Menu, choose Instrument Controls > Datalogging Settings > Configure Datalogging > **Memory Allocation %**.

```

SET PERCENT LRECS:
CURRENTLY:           50%
SET TO:              30% ?

↑↓ CHANGE VALUE    ← SAVE

RANGE  AVG  DIAGS  ALARM
  
```

```

SET PERCENT LRECS:
CURRENTLY:           50%
SET TO:              30% ?
THIS WILL ERASE ALL LOGS!
PRESS → TO CONFIRM CHANGE

RANGE  AVG  DIAGS  ALARM
  
```

## Data Treatment

The Data Treatment screen is used to select the data type for the selected record type: whether the data should be averaged over the interval, the minimum or maximum measured during the interval, or the current value (last value measured). Data treatment doesn't apply to all data, just to the concentration measurement. All other data points log the current value at the end of the interval.

**Note** This feature is found in all *i*Series instruments, but it is recommended that the data type be set to ONLY the current value (cur), as the datalogging averaging is done in addition to the normal concentration averaging. ▲

- In the Main Menu, choose Instrument Controls > Datalogging Settings > Configure Datalogging > **Data Treatment**.

```
SET LREC DATA TYPE:
CURRENTLY:  AVG
SET TO:    CUR      ?
↑↓ CHANGE VALUE  ← SAVE
RANGE  AVG  DIAGS ALARM
```

## Flag Status Data

The Flag Status Data screen is used to set the flag status data to either ON or OFF for the selected record type.

- In the Main Menu, choose Instrument Controls > Datalogging Settings > Configure Datalogging > **Flag Status Data**.

```
SET LREC FLAG STATUS DATA:
CURRENTLY:  OFF
SET TO:    ON      ?
↑↓ CHANGE VALUE  ← SAVE
RANGE  AVG  DIAGS ALARM
```

## Communication Settings

The Communication Settings menu is used for communications control and configuration.

- In the Main Menu, choose Instrument Controls > **Communication Settings**.

```

COMMUNICATION SETTINGS:
>SERIAL SETTINGS
  INSTRUMENT ID
  GESYTEC SERIAL NO
  COMMUNICATION PROTOCOL
  STREAMING DATA CONFIG

  RANGE  AVG  DIAGS  ALARM

TCP/IP SETTINGS
  
```

### Serial Settings

The Serial Setting submenu is used for serial communications control and configuration.

- In the Main Menu, choose Instrument Controls > Communication Settings > **Serial Settings**.

```

SERIAL SETTINGS:
>BAUD RATE           9600
  DATA BITS         8
  PARITY             NONE
  STOP BITS          1
  RS-232/485 SEL     RS-232

  RANGE  AVG  DIAGS  ALARM
  
```

### Baud Rate

The Baud Rate screen is used to set the RS-232/RS-485 interface baud rate. Baud rates of 1200, 2400, 4800, 9600, 19200, 38400, 57600, and 115200 are available. The analyzer's default baud rate is set to 9600 to provide backwards compatibility with the older C-series analyzers.

- In the Main Menu, choose Instrument Controls > Communication Settings > Serial Settings > **Baud Rate**.

```

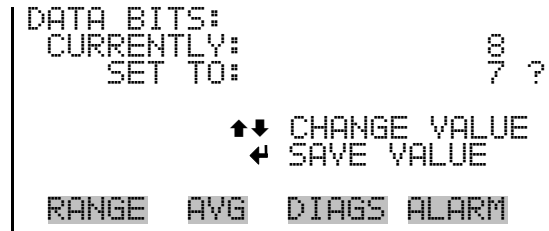
BAUD RATE:
  CURRENTLY:           9600
  SET TO:              19200 ?

      ↑↓ CHANGE VALUE
      ← SAVE VALUE

  RANGE  AVG  DIAGS  ALARM
  
```

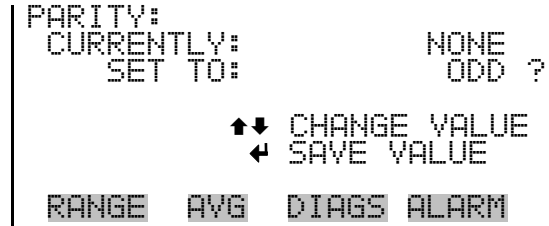
**Data Bits** The Data Bits screen is used to set the number of serial data bits to either 7 or 8 (default).

- In the Main Menu, choose Instrument Controls > Communication Settings > Serial Settings > **Data Bits**.



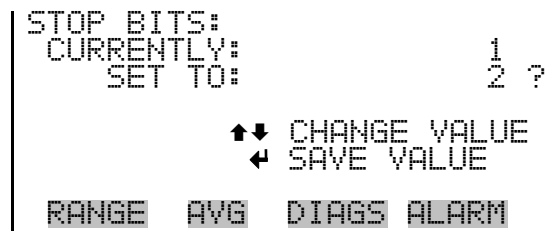
**Parity** The Parity screen is used to select the parity bit for the serial port to None (default), Even, or Odd.

- In the Main Menu, choose Instrument Controls > Communication Settings > Serial Settings > **Parity**.



**Stop Bits** The Stop Bits screen is used to set the number of stop bits for the serial port to 1 (default) or 2.

- In the Main Menu, choose Instrument Controls > Communication Settings > Serial Settings > **Stop Bits**.



**RS-232/RS-485 Selection** The RS-232/RS-485 Selection screen allows the user to choose between the RS-232 or RS-485 specification for serial communication.



**Equipment Damage** Disconnect the serial cable before changing the RS-232 and RS-485 selection to prevent damage to any equipment currently connected to the analyzer. ▲

- In the Main Menu, choose Instrument Controls > Communication Settings > Serial Settings > **RS-232/485 Selection**.

```

RS-232/RS-485 SELECT:
** WARNING **
DISCONNECT THE SERIAL
CABLES BEFORE CHANGING
THE SELECTION!
      ← TO CONTINUE

RANGE  AVG  DIAGS  ALARM
  
```

```

RS-232/RS-485 SELECT:
CURRENTLY:      RS-232
SET TO:         RS-485 ?
MAKE SURE THAT THE CABLE
IS OFF: PRESS → TO CONFIRM
      ← TOGGLE VALUE

RANGE  AVG  DIAGS  ALARM
  
```

**Instrument ID** The Instrument ID screen allows the operator to edit the instrument ID number. The ID is used to identify the instrument when using the C-Link or MODBUS protocols to control the instrument or collect data. It may be necessary to edit the ID number if two or more instruments of the same model are connected to one computer. Valid instrument ID numbers are from 0 to 127. The Model 5014i has a default instrument ID of 14. For more information about the instrument ID, see Appendix B “C-Link Protocol” or Appendix C “MODBUS Protocol”.

- In the Main Menu, choose Instrument Controls > Communication Settings > **Instrument ID**.

```

INSTRUMENT ID:
CURRENTLY:      14
SET TO:         16 ?

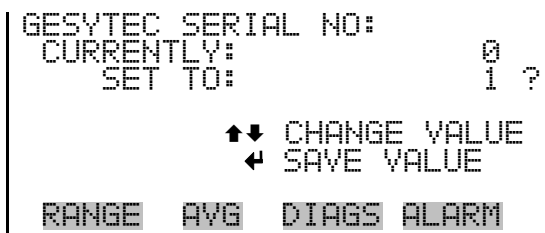
      ↑↓ CHANGE VALUE
      ← SAVE VALUE

RANGE  AVG  DIAGS  ALARM
  
```

### Gesytec Serial Number

The Gesytec Serial Number screen is used to set the serial number for the Gesytec protocol. The Gesytec serial number defaults to zero. For more information about the serial number, see Appendix D, “Gesytec (BH) Protocol”.

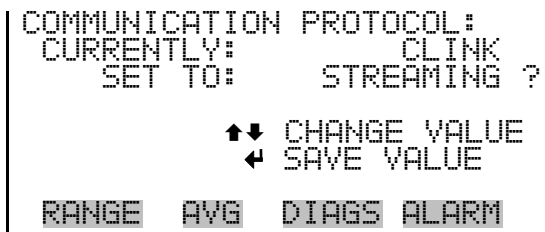
- In the Main Menu, choose Instrument Controls > Communication Settings > **Gesytec Serial No.**



### Communication Protocol

The Communication Protocol screen is used to change the protocol for serial communications. Possible choices include: C-Link, MODBUS, Gesytec, and Streaming Data.

- In the Main Menu, choose Instrument Controls > Communication Settings > **Communication Protocol.**



### Streaming Data Configuration

The Streaming Data Configuration menu is used to allow for configuration of the 8 streaming data output items, streaming interval, current data format, and current timestamp setting. The Choose Stream Data submenu displays a list of the analog output signal group choices to choose from. Choices are Concentrations, Other Measurements, and Analog Inputs (if the I/O expansion board option is installed).

- In the Main Menu, choose Instrument Controls > Communication Settings > **Streaming Data Config.**

```

STREAMING DATA CONFIG
>INTERVAL          10 SEC
ADD LABELS        NO
PREPEND TIMESTAMP YES
ADD FLAGS         YES
ITEM 1            PM
RANGE  AVG  DIAGS  ALARM
  
```

### Streaming Data Interval

The Streaming Data Interval screen is used to adjust how frequently a new record will be generated. The following interval times are available: 1, 2, 5, 10, 20, 30, 60, 90, 120, 180, 240, and 300 seconds.

- In the Main Menu, choose Instrument Controls > Communication Settings > Streaming Data Config > **Interval**.

```

STREAMING DATA INTERVAL:
CURRENTLY:          10 SEC
SET TO:            20 SEC ?
                    ↑↓ CHANGE VALUE
                    ← SAVE VALUE
RANGE  AVG  DIAGS  ALARM
  
```

**Note** Add Labels, Prepend Timestamp, and Add Flags are toggle items that change between yes or no when selected. ▲

### Choose Stream Data

The Choose Stream Data screen displays a list of the types of data that can be sent via streaming data. Choices are Concentrations, Other Measurements, and Analog Inputs (if the I/O expansion board is installed).


- In the Main Menu, choose Instrument Controls > Communication Settings > Streaming Data Config > **Item 1–8**.

```

CHOOSE STREAM DATA:
>CONCENTRATIONS
OTHER MEASUREMENTS
ANALOG INPUTS
RANGE  AVG  DIAGS  ALARM
  
```

### Concentrations


The Concentrations screen allows the user to assign one of the concentrations to the selected streaming data item. The currently selected

item is shown by “<--” after it. Once an item is selected, pressing  will save the selected streaming data item.

- In the Main Menu, choose Instrument Controls > Communication Settings > Streaming Data Config > select Item > **Concentrations**.

```
CONCENTRATIONS:
>NONE
PM
AVG PM
                                     <--
RANGE  AVG  DIAGS  ALARM
```

### Other Measurements

The Other Measurements screen allows the user to assign one of the other available measurement types to the selected streaming data item. The currently selected item is shown by “<--” after it. Once an item is selected, pressing  will save the selected streaming data item. For Common Flags and Detector A Flags, see [Figure 3-5](#) and [Figure 3-6](#) for data descriptions.


- In the Main Menu, choose Instrument Controls > Communication Settings > Streaming Data Config > select Item > **Other Measurements**.

```
OTHER MEASUREMENTS:
>NONE
BARO PRES
VACUUM
FLOW PRES
AMB RH
                                     ↓
RANGE  AVG  DIAGS  ALARM
```

```
SAMP RH
AMB TEMP
BRD TEMP
FLOW TEMP
FLOW VOL
BETA
BETA RAW
ALPHA RAW
MASS
BETA ZERO
EXT ALARMS
BETA REF
COMMON FLAGS
DET A FLAGS
MASSCMP
```



### Analog Inputs

The Analog Inputs screen allows the user to assign an analog input signal (none or analog inputs 1–8) to the selected streaming data item. The currently selected item is shown by “<--” after it. Once an item is selected, pressing  will save the selected streaming data item.

- In the Main Menu, choose Instrument Controls > Communication Settings > Streaming Data Config > select Item > **Analog Inputs**.

```

ANALOG INPUTS:
>NONE
ANALOG IN 1
ANALOG IN 2
ANALOG IN 3
ANALOG IN 4
                                     ↓
RANGE  AVG  DIAGS  ALARM
  
```

### TCP/IP Settings

The TCP/IP Settings menu is used for defining parameters that are required for Ethernet communications.

**Note** The instrument power must be cycled after any of these parameters have been changed for the change to take effect. ▲

- In the Main Menu, choose Instrument Controls > Communication Settings > **TCP/IP Settings**.

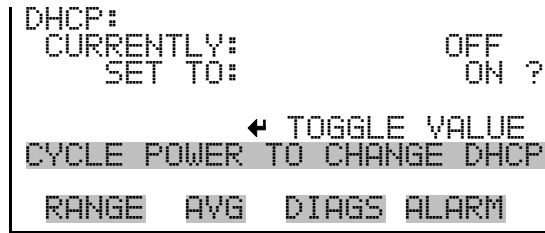
```

TCP/IP SETTINGS:
>USE DHCP                OFF
IP ADDR      10.209.40.149
NETMASK      255.255.252.0
GATEWAY      10.209.42.1
HOST NAME    Iseries ↓
RANGE  AVG  DIAGS  ALARM
NTP SVR      10.209.43.237
  
```

### Use DHCP

The Use DHCP screen is used to specify whether to use Dynamic Host Configuration Protocol (DHCP) or not. When DHCP is enabled, the network dynamically provides an IP address for the instrument.

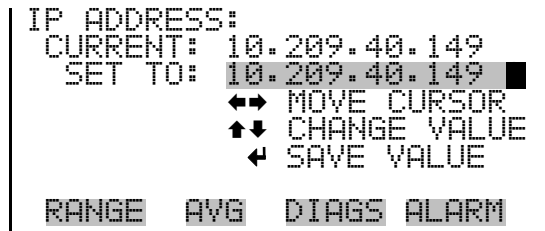
- In the Main Menu, choose Instrument Controls > Communication Settings > TCP/IP Settings > **Use DHCP**.



**IP Address**

The IP Address screen is used to edit the IP address. The IP address can only be changed when DHCP is off. If DHCP is on, the instrument will respond with “NOT SETTABLE IF DHCP IS ON”. For more information on DHCP, see “Use DHCP” above.

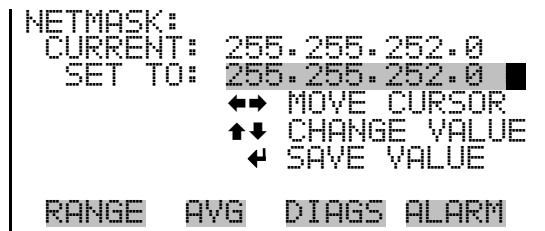
- In the Main Menu, choose Instrument Controls > Communication Settings > TCP/IP Settings > **IP Addr.**



**Netmask**

The Netmask screen is used to edit the netmask. The netmask is used to determine the subnet on which the instrument can directly communicate to other devices. The netmask can only be changed when DHCP is off. If DHCP is on, the instrument will respond with “NOT SETTABLE IF DHCP IS ON”. For more information on DHCP, see “Use DHCP” above.

- In the Main Menu, choose Instrument Controls > Communication Settings > TCP/IP Settings > **Netmask.**



**Default Gateway**

The Default Gateway screen is used to edit the gateway address. The default gateway can only be changed when DHCP is off. If DHCP is on,

the instrument will respond with “NOT SETTABLE IF DHCP IS ON”. For more information on DHCP, see “[Use DHCP](#)” above. Any traffic to addresses that are not on the local subnet will be routed through this address.

- In the Main Menu, choose Instrument Controls > Communication Settings > TCP/IP Settings > **Gateway**.

```

DEFAULT GATEWAY:
CURRENT: 10.209.42.1
SET TO: 10.209.42.1
      ←→ MOVE CURSOR
      ↑↓ CHANGE VALUE
      ← SAVE VALUE

RANGE  AVG  DIAGS  ALARM
  
```

**Host Name** The Host Name screen is used to edit the host name. When DHCP is enabled, this name is reported to the DHCP server.

- In the Main Menu, choose Instrument Controls > Communication Settings > TCP/IP Settings > **Host Name**.

```

HOST NAME:
CURRENT: I SERIES
      I SERIES ?
      ABCDEFGHIJKLMNOP BKSP
      OPQRSTUVWXYZ PAGE
      0123456789 ./- SAVE

RANGE  AVG  DIAGS  ALARM
  
```

**Network Time Protocol Server** The Network Time Protocol (NTP) Server screen is used to edit the IP address of the NTP server. An NTP server may be used to periodically synchronize the instrument’s real-time clock with a standard. More information about the NTP servers and a list of public servers may be found at <http://www.ntp.org>.

- In the Main Menu, choose Instrument Controls > Communication Settings > TCP/IP Settings > **NTP Svr.**

```

NTP SERVER IP ADDRESS:
CURRENT: 10.209.43.237
SET TO: 10.209.43.237
  ↔ MOVE CURSOR
  ↑↓ CHANGE VALUE
  ← SAVE VALUE

RANGE  AVG  DIAGS  ALARM
    
```

## I/O Configuration

The I/O Configuration menu deals with configuration of the analyzer's I/O system. The analog input configuration is displayed only if the I/O expansion board option is installed.

- In the Main Menu, choose Instrument Controls > **I/O Configuration**.

```

I/O CONFIGURATION:
>OUTPUT RELAY SETTINGS
DIGITAL INPUT SETTINGS
ANALOG OUTPUT CONFIG
ANALOG INPUT CONFIG

RANGE  AVG  DIAGS  ALARM
    
```

## Output Relay Settings

The Output Relay Settings menu displays a list of the 10 digital output relays available, and allows the user to select the logic state and instrument parameter for the relay selected.

**Note** The digital outputs may take up to one second after the assigned state occurs to show up on the outputs. ▲

- In the Main Menu, choose Instrument Controls > I/O Configuration > **Output Relay Settings**.


```

OUTPUT RELAY SETTINGS:
>1  NOP          CONC ALARM
 2  NOP          LOCAL/REMOTE
 3  NOP          UNITS
 4  NOP          GEN ALARM
 5  NOP          NONE ↓

RANGE  AVG  DIAGS  ALARM
    
```

## Logic State

The Logic State menu item is used to change the selected I/O relay to either normally open or normally closed. The default state is open, which indicates that a relay connected between the digital output pin and ground is normally open and closes to trigger the digital output action.

- Press  to toggle and set the logic state to normally open or normally closed.

```

OUTPUT RELAY SETUP:
>LOGIC STATE      OPEN
INSTRUMENT STATE

RANGE  AVG  DIAGS  ALARM
  
```

### Instrument State

The Instrument State submenu allows the user to select the instrument state that is assigned to the selected relay output. A submenu lists signal types of either alarms or non-alarm to choose from.

- In the Main Menu, choose Instrument Controls > I/O Configuration > Output Relay Settings > select Relay > **Instrument State**.

```

CHOOSE SIGNAL TYPE:
>ALARMS
NON-ALARM

RANGE  AVG  DIAGS  ALARM
  
```

### Alarms

The Alarms screen allows the user to select an alarm status for the selected relay output. The currently selected item is shown by “<--” after it. The I/O board status alarm is only present if the I/O expansion board is installed.

- In the Main Menu, choose Instrument Controls > I/O Configuration > Output Relay Settings > select Relay > Instrument State > **Alarms**.

```

ALARM STATUS ITEMS:
>NONE
GEN ALARM
CONC ALARM      <--
INST ALARMS
DET ALARMS      ↓

RANGE  AVG  DIAGS  ALARM

RH/TEMP ALARMS
PRES/VAC ALARMS
FLOW ALARMS
  
```

**Non-Alarm** The Non-Alarm screen allows the user to select a non-alarm status for the selected relay output. The currently selected item is shown by “<--” after it.

- In the Main Menu, choose Instrument Controls > I/O Configuration > Output Relay Settings > select Relay > Instrument State > **Non-Alarm**.

```
NON ALARM STATUS ITEMS:
>NONE
LOCAL/REMOTE
SERVICE
UNITS
MODE A
RANGE  AVG  DIAGS  ALARM
```

**Digital Input Settings** The Digital Input Settings menu displays a list of the 16 digital inputs available, and allows the user to select the logic state and instrument parameter for the relay selected.


**Note** The digital inputs must be asserted for at least one second for the action to be activated. ▲

Not all of the I/O available in the instrument are brought out on the supplied terminal board. If more I/O is desired, an alternative means of connection is required. (See optional “[Terminal Block and Cable Kits](#)”.) ▲

- In the Main Menu, choose Instrument Controls > I/O Configuration > **Digital Input Settings**.

```
DIGITAL INPUT SETTINGS:
>1  NOP          MODE A
2  NOP          AOUTS TO ZERO
3  NOP          PUMP CNTRL
4  NOP          PRES CNTRL
5  NOP          NONE ↓
RANGE  AVG  DIAGS  ALARM
```

**Logic State** The Logic State menu item is used to change the selected I/O relay to either normally open or normally closed. The default state is open, which indicates that a relay connected between the digital input pin and ground is normally open and closes to trigger the digital input action.

- Press  to toggle and set the logic state to normally open or normally closed.

```
DIGITAL INPUT SETUP:
>LOGIC STATE          OPEN
INSTRUMENT ACTION

RANGE  AVG  DIAGS  ALARM
```

### Instrument Action

The Instrument Action submenu allows the user to choose the instrument action that is assigned to the selected digital input.

- In the Main Menu, choose Instrument Controls > I/O Configuration > Digital Input Settings > select Relay > **Instrument Action**.

```
CHOOSE ACTION:
>NONE
MODE A
AOUTS TO ZERO
AOUTS TO FS
FT COUNT
↓
RANGE  AVG  DIAGS  ALARM
```

```
FT CNTRL
PUMP CNTRL
TEMP CNTRL
PRES CNTRL
HT CNTRL A
RH/TEMP CNTRL A
ALARM 1
ALARM 2
ALARM 3
```

### Analog Output Configuration (Select Channel)

The Analog Output Configuration menu displays a list of the analog output channels available for configuration. Channel choices include all voltage channels, all current channels, individual voltage channels 1–6, and individual current channels 1–6 (if the I/O expansion board option is installed).

- In the Main Menu, choose Instrument Controls > I/O Configuration > **Analog Output Config**.

```

OUTPUT CHANNELS:
>ALLOW OVER/UNDER RANGE
  ALL VOLTAGE CHANNELS
  ALL CURRENT CHANNELS
  VOLTAGE CHANNEL 1
  VOLTAGE CHANNEL 2
                                     ↓
RANGE  AVG  DIAGS  ALARM
    
```

### Allow Over/Under Range

The Allow Over/Under Range screen is used to select whether or not the analog outputs are allowed to exceed the maximum selected value of 100 mV, 1 V, 5 V, 10 V, or 20 mA or the minimum selected value of 0 V, 0 mA, or 4 mA. By default, this parameter is set to on and 5% over and under range is allowed for all analog output channels.

- In the Main Menu, choose Instrument Controls > I/O Configuration > Analog Output Config > **Allow Over/Under Range**.

```

ALLOW OVER/UNDER RANGE:
CURRENTLY:                ON
SET TO:                   OFF  ?
                            ← TOGGLE VALUE
RANGE  AVG  DIAGS  ALARM
    
```

### Analog Output Configuration (Select Action)

The Analog Output Configuration menu displays a list of the analog output configuration choices, from which the user selects the parameter to adjust for the selected output channel. Configuration choices include selecting range, setting minimum/maximum values, and choosing the signal to output.

- In the Main Menu, choose Instrument Controls > I/O Configuration > Analog Output Config > **All Voltage Channels, All Current Channels, Voltage Channel 1–6 or Current Channel 1–6**.

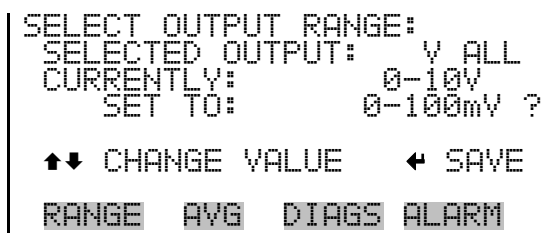
```

ANALOG OUTPUT CONFIG:
>SELECT RANGE
  SET MINIMUM VALUE
  SET MAXIMUM VALUE
  CHOOSE SIGNAL TO OUTPUT
RANGE  AVG  DIAGS  ALARM
    
```



**Select Range** The Select Range screen is used to select the hardware range for the selected analog output channel. Possible ranges for the voltage outputs are: 0-100 mV, 0-1, 0-5, and 0-10 V. Possible ranges for the current outputs are: 0-20 mA and 4-20 mA.

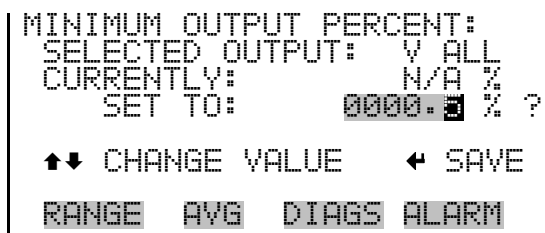
- In the Main Menu, choose Instrument Controls > I/O Configuration > Analog Output Config > select Channel > **Select Range**.



**Minimum and Maximum Value**

The Minimum and Maximum Value screens are used to edit the zero (0) and full-scale (100) values, respectively, in percentages for the selected analog output channel. See [Table 3-4](#) for a list of choices. The minimum and maximum output value screens function the same way. The following example shows the set minimum value screen.

- In the Main Menu, choose Instrument Controls > IO Configuration > Analog Output Config > select Channel > **Set Minimum** or **Maximum Value**.



**Table 3-4.** Analog Output Zero to Full-Scale

Output	Zero (0)% Value	Full-Scale 100% Value
PM	Zero (0)	Range Setting
AVG PM	Zero (0)	Range Setting
Barometer Pressure	User-set alarm min value	User-set alarm max value
Vacuum	User-set alarm min value	User-set alarm max value

## Operation

### Instrument Controls Menu

Output	Zero (0)% Value	Full-Scale 100% Value
Flow Pressure	User-set alarm min value	User-set alarm max value
Ambient RH	User-set alarm min value	User-set alarm max value
Sample RH	User-set alarm min value	User-set alarm max value
Ambient Temp	User-set alarm min value	User-set alarm max value
Board Temp	User-set alarm min value	User-set alarm max value
Flow Temp	User-set alarm min value	User-set alarm max value
Flow Vol	User-set alarm min value	User-set alarm max value
Beta	User-set alarm min value	User-set alarm max value
Beta Raw	User-set alarm min value	User-set alarm max value
Alpha Raw	User-set alarm min value	User-set alarm max value
Mass	-200	5,000
Beta Zero	0	65,000
External Alarms	0	7,000
Beta Ref	0	65,000

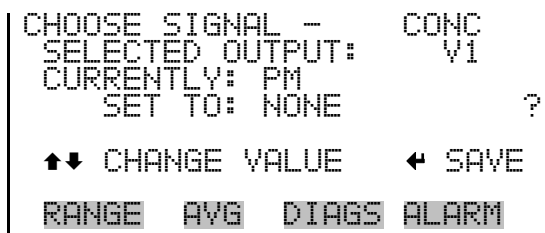
### Choose Signal to Output

The Choose Signal to Output screen displays a list of the analog output signal choices. Choices are grouped into three categories: Concentrations, Other Measurements, and Analog Inputs (if the I/O expansion board option is installed). This allows the user to select the output signal that will be assigned to each analog channel. The Concentrations screen is shown below. See [Table 3-5](#) for a list of items for each signal group choice.

- In the Main Menu, choose Instrument Controls > I/O Configuration > Analog Output Config > select Channel > **Choose Signal to Output**.

```
CHOOSE SIGNAL TYPE:
>CONCENTRATIONS
  OTHER MEASUREMENTS
  ANALOG INPUTS

RANGE  AVG  DIAGS  ALARM
```



**Table 3–5.** Signal Type Group Choices

Concentrations	Other Measurements	Analog Inputs
None	None	None
PM	Barometer Pressure	Analog Input 1 (if the I/O expansion board is installed)
AVG PM	Vacuum	Analog Input 2 (if the I/O expansion board is installed)
	Flow Pressure	Analog Input 3 (if the I/O expansion board is installed)
	Ambient RH	Analog Input 4 (if the I/O expansion board is installed)
	Sample RH	Analog Input 5 (if the I/O expansion board is installed)
	Ambient Temp	Analog Input 6 (if the I/O expansion board is installed)
	Board Temp	Analog Input 7 (if the I/O expansion board is installed)
	Flow Temp	Analog Input 8 (if the I/O expansion board is installed)
	Flow Vol	
	Beta	
	Beta Raw	
	Alpha Raw	
	Mass	
	Beta Zero	
	External Alarms	
	Beta Ref	
	Common Flags	
	Det A Flags	

**Analog Input Configuration** The Analog Input Configuration menu displays a list of the 8 analog input channels available for configuration. This screen is only displayed if the I/O expansion board option is installed. Configuration includes entering the Descriptor, Units, Decimal Places, choice of 1–10 points in the table, and corresponding number of points selected.

- In the Main Menu, choose Instrument Controls > I/O Configuration > **Analog Input Config.**

```
ANALOG INPUT CONFIG:
>CHANNEL 1          IN1
CHANNEL 2          IN2
CHANNEL 3          IN3
CHANNEL 4          IN4
CHANNEL 5          IN5 ↓
RANGE  AVG  DIAGS  ALARM
```

```
ANALOG INPUT 01 CONFIG:
>DESCRIPTOR          IN1
UNITS                V
DECIMAL PLACES      2
TABLE POINTS        2
POINT 1
RANGE  AVG  DIAGS  ALARM
```

POINT 2

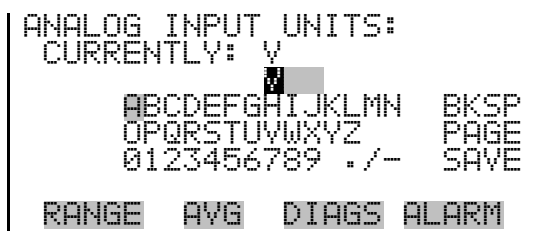
**Descriptor** The Descriptor screen allows the user to enter the descriptor, or name, for the selected analog input channel. The descriptor is used in datalogging and streaming data to report what data is being sent out. The descriptor may be from 1 to 3 characters in length, and defaults to IN1 to IN8 (user input channel number).

- In the Main Menu, choose Instrument Controls > I/O Configuration > Analog Input Config > select Channel > **Descriptor.**

```
ANALOG INPUT DESCRIPTOR:
CURRENTLY: IN1
          IN1
          ABCDEFGHIJKLMN  BKSP
          OPQRSTUVWXYZ   PAGE
          0123456789 ./-  SAVE
RANGE  AVG  DIAGS  ALARM
```

**Units** The Units screen allows the user to enter the units for the selected analog input channel. The units are displayed on the diagnostic screen and in datalogging and streaming data. The units may be from 1 to 3 characters in length, and defaults to V (volts).

- In the Main Menu, choose Instrument Controls > I/O Configuration > Analog Input Config > select Channel > **Units**.



**Decimal Places** The Decimal Places screen allows the user to select how many digits are displayed to the right of the decimal point, from 0 to 6, with a default of 2.

- In the Main Menu, choose Instrument Controls > I/O Configuration > Analog Input Config > select Channel > **Decimal Places**.



**Number of Table Points** The Number of Table Points screen allows the user to select how many points are used in the analog input conversion table for the selected channel. The instrument uses linear interpolation between the points in this table to determine what the reading value is based on the analog input voltage. Each point in the table consists of an analog input voltage value (0–10.5 V) and a corresponding reading value. Only two points are necessary for linear inputs, however a larger number of points may be used to approximate non-linear inputs. The points range from 2 to 10, with a default of 2.

- In the Main Menu, choose Instrument Controls > I/O Configuration > Analog Input Config > select Channel > **Table Points**.

```
NUMBER OF TABLE POINTS:
CURRENTLY:                2
SET TO:                   10 ?

      ↑↓ INC/DEC
      ← SAVE VALUE

RANGE  AVG  DIAGS  ALARM
```

**Table Points** The Table Point submenu allows the user to set up an individual table point.

- In the Main Menu, choose Instrument Controls > I/O Configuration > Analog Input Config > select Channel > **Point 1–10**.

```
TABLE POINT 01 CONFIG:
>VOLTS                   0.00
USER VALUE                0.00

RANGE  AVG  DIAGS  ALARM
```

**Volts** The Volts screen allows the user to set the input voltage for the selected table point in the conversion table, from 0.00 to 10.50. The default table is a two-point table with point 1: 0.00 V = 000.0 U and point 2: 10.00 V = 10.0 U, where U is the previously entered unit of measure.

- In the Main Menu, choose Instrument Controls > I/O Configuration > Analog Input Config > select Channel > select Point > **Volts**.

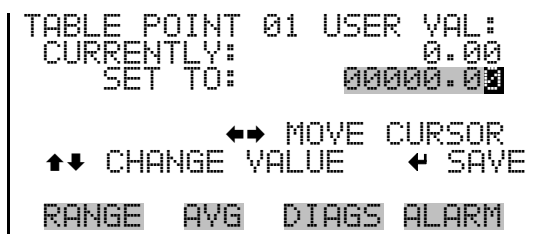
```
TABLE POINT 01 VOLTS:
CURRENTLY:                0.00
SET TO:                   00.00

      ↔ MOVE CURSOR
      ↑↓ CHANGE VALUE  ← SAVE

RANGE  AVG  DIAGS  ALARM
```

**User Value** The User Value screen allows the user to set the output value for the corresponding input voltage for the selected table point in the conversion table, from -9999999 to 99999999. The default table is a two-point table with point 1: 0.00 V = 000.0 U and point 2: 10.00 V = 10.0 U, where U is the previously entered unit of measure.

- In the Main Menu, choose Instrument Controls > I/O Configuration > Analog Input Config > select Channel > select Point > **User Value**.



## Screen Contrast

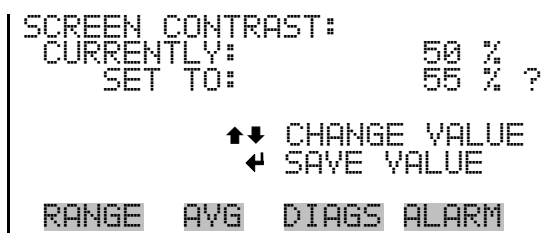
The Screen Contrast screen is used to change the contrast of the display. Intensities between 0 and 100% in increments of 5 are available. Changing the screen contrast may be necessary if the instrument is operated at extreme temperatures.

**Note** The optimal contrast will change with changes in temperature. ▲

**Note** The optimal contrast will change from one LCD to another. If the LCD is replaced, the contrast may need to be reset. ▲

If the display contrast is not optimal, but the content on the screen is visible, select Instrument Controls > **Screen Contrast** and adjust the screen contrast. If the content on the screen is not visible, use the “set contrast 10” C-Link command to set the screen contrast to mid-range, then optimize the contrast. See “contrast levels” in Appendix B, “[C-Link Protocol Commands](#)” for more information on this command. ▲

- In the Main Menu, choose Instrument Controls > **Screen Contrast**.



## Service Mode

The Service Mode screen is used to turn the service mode on or off. Turning service mode “ON” locks out any remote actions and allows access to parameters and functions that are useful when making adjustments or

diagnosing the Model 5014*i*. The service (wrench) icon on the status bar is shown when service mode is on. For more information about the service mode, see “[Service Menu](#)” later in this chapter.

**Note** The service mode should be turned off when finished, as it prevents remote operation. ▲

- In the Main Menu, choose Instrument Controls > **Service Mode**.

```
SERVICE MODE:
CURRENTLY:    OFF
SET TO:      ON ?

      ← TOGGLE VALUE

RANGE  AVG  DIAGS  ALARM
```

**Date/Time** The Date/Time screen allows the user to view and change the system date and time (24-hour format). The internal clock is powered by its own battery when instrument power is off.

- In the Main Menu, choose Instrument Controls > **Date/Time**.

```
DATE AND TIME:
19 MAR 2005 12:34:56
PRESS ← TO EDIT

RANGE  AVG  DIAGS  ALARM
```

```
DATE AND TIME:
19 MAR 2005 12:34:56 ?
SETTING: DAYS
  → SET MONTHS
  ↑↓ CHANGE VALUE
  ← SAVE VALUE

RANGE  AVG  DIAGS  ALARM
```

**Timezone** The Timezone screen is used to set the timezone for the Network Time Protocol (NTP) server. This should be set to the timezone that the instrument is located in. If the exact timezone is not shown in the list, it may be entered via the C-LINK “tz” command (see Appendix B). The selections are: UTC (GMT), EST (GMT+5), CST (GMT+6), MST (GMT+7), PST (GMT+8), YST (GMT+9), HST (GMT+10), NST (GMT+11), DLW (GMT+12), CET (GMT-1), EET (GMT-2), BST (GMT-3), DLT (GMT-4), ECH (GMT-5), FOX (GMT-6), GLF (GMT-7), CCT (GMT-8), JST (GMT-9), GST (GMT-10), LMA (GMT-11), DLE (GMT-12), EDT (GMT+5/4), CDT (GMT+6/5), MDT (GMT+7/6), and PDT (GMT+8/7).



**Note** The current timezone may say NULL before the timezone is set for the first time, or if the timezone was cleared with a C-Link command. ▲

- In the Main Menu, choose Instrument Controls > **Timezone**.

```

TIMEZONE FOR TIMESERVER:
CURRENTLY: UTC (GMT)
SET TO: EST (GMT+5) ?

      ↑↓ CHANGE VALUE
      ← SAVE VALUE

RANGE  AVG  DIAGS  ALARM
  
```

## Diagnostics Menu

The Diagnostics menu provides access to diagnostic information and functions. This menu is useful when troubleshooting the instrument. The analog input readings and analog input voltages are only displayed if the I/O expansion board option is installed.

- In the Main Menu, choose **Diagnostics**.

```

DIAGNOSTICS:
>PROGRAM VERSIONS
VOLTAGES
RH/TEMPERATURE
PRESSURE/VACUUM
FLOW
                                     ↓

RANGE  AVG  DIAGS  ALARM
  
```

```

DETECTOR STATUS
CRn
ANALOG INPUT READINGS
ANALOG INPUT VOLTAGES
DIGITAL INPUTS
RELAY STATES
TEST ANALOG OUTPUTS
INSTRUMENT CONFIGURATION
CONTACT INFORMATION
  
```

## Program Versions

The Program Versions screen (read only) shows the version numbers of the programs installed. Prior to contacting the factory with any questions regarding the instrument, please note the product model name and the program version numbers.

- In the Main Menu, choose Diagnostics > **Program Versions**.

```
PROGRAM VERSIONS:  
PRODUCT:      MODEL 5014i  
VERSION:      00.00.32.073  
FIRMWARE:     10.22.95  
  
RANGE  AVG  DIAGS  ALARM
```

## Voltages

The Voltages menu displays the current diagnostic voltage readings. This screen enables the power supply to be quickly read for low or fluctuating voltages without having to use a voltage meter. The I/O board item is only displayed if the I/O expansion board option is installed.

- In the Main Menu, choose Diagnostics > **Voltages**.

```
VOLTAGES:  
>MOTHERBOARD  
INTERFACE BOARD  
I/O BOARD  
DETECTOR BOARD  
  
RANGE  AVG  DIAGS  ALARM
```

## Motherboard Voltages

The Motherboard screen (read only) is used to display the voltage readings on the motherboard.

- In the Main Menu, choose Diagnostics > Voltages > **Motherboard**.

```
MOTHERBOARD VOLTAGES:  
3.3 SUPPLY          3.3 V  
5.0 SUPPLY          5.0 V  
15.0 SUPPLY         15.0 V  
24.0 SUPPLY         24.1 V  
-3.3 SUPPLY         -3.3 V  
  
RANGE  AVG  DIAGS  ALARM
```

## Interface Board Voltages

The Interface Board screen (read only) is used to display the voltage readings on the measurement interface board.

- In the Main Menu, choose Diagnostics > Voltages > **Interface Board**.

```

INTERFACE BOARD VOLTAGES:
 3.3 SUPPLY          3.3 V
 5.0 SUPPLY          5.0 V
15.0 SUPPLY          15.0 V
24.0 SUPPLY          24.0 V
-15.0 SUPPLY         -15.0 V

RANGE  AVG  DIAGS  ALARM
  
```

### I/O Board Voltages

The I/O Board screen (read only) is used to display the voltage readings on the I/O expansion board. This menu is only displayed if the I/O expansion board option is installed.

- In the Main Menu, choose Diagnostics > Voltages > **I/O Board**.

```

I/O BOARD VOLTAGES:
 3.3 SUPPLY          3.3 V
 5.0 SUPPLY          5.0 V
24.0 SUPPLY          24.0 V
-3.3 SUPPLY          -3.3 V

RANGE  AVG  DIAGS  ALARM
  
```

### Detector Board Voltages

The Detector Board screen (read only) is used to display the voltage readings on the measurement interface board.

- In the Main Menu, choose Diagnostics > Voltages > **Detector Board**.

```

DETECTOR BOARD:
 5.0 SUPPLY          5.0 V

RANGE  AVG  DIAGS  ALARM
  
```

### RH/Temperature

The RH/Temperature screen (read only) displays the current relative humidity and temperature readings. The board temperature is the air temperature measured by a sensor located on the measurement interface board.

- In the Main Menu, choose Diagnostics > **RH/Temperature**.

```
RH/TEMPERATURES:
>AMBIENT RH      40.0  %
SAMPLE RH       36.4  %
AMBIENT TEMP    22.9  °C
FLOW TEMP      23.9  °C
BOARD TEMP     24.9  °C↓
RANGE  AVG  DIAGS  ALARM
```

## Pressure/Vacuum

The Pressure/Vacuum screen (read only) displays the current pressure readings. The pressure is measured by a pressure transducer. The vacuum is the amount of vacuum under the filter tape. The flow pressure is the pressure differential across the orifice.

- In the Main Menu, choose Diagnostics > **Pressure/Vacuum**.

```
PRESSURE/VACUUM:
BAROMETRIC      760.1 mmHg
VACUUM          60.5 mmHg
FLOW            21.5 mmHg
RANGE  AVG  DIAGS  ALARM
```

## Flow

The Flow screen (read only) displays the current sample flow reading. The flow is measured by the internal pressure board sensors.

- In the Main Menu, choose Diagnostics > **Flow**.

```
FLOW:           16.67 LPM
RANGE  AVG  DIAGS  ALARM
```

## Detector Status

The Detector Status screen (read only) displays the current sample mass reading, alpha counts, and beta counts.

**Note** A mass value will only be calculated when the flowrate is within acceptable limits. However, when in Service Mode, a mass value will be calculated if the pump is turned OFF. ▲

- In the Main Menu, choose Diagnostics > **Detector Status**.

```

DETECTOR STATUS:
MASS                0 ug
ALPHA                2 1/sec
BETA                13577 1/sec
BETA CORR           13577 1/sec
BETA ZERO           6500 1/sec

RANGE  AVG  DIAGS  ALARM
  
```

**CRn** The CRn screen (read only) displays the current CRn reading.

- In the Main Menu, choose Diagnostics > **CRn**.

```

CRn                0.00 Bq/m3

RANGE  AVG  DIAGS  ALARM
  
```

### Analog Input Readings

The Analog Input Readings screen (read only) displays the 8 user-scaled analog readings (if the I/O expansion board option is installed).

- In the Main Menu, choose Diagnostics > **Analog Input Readings**.

```

ANALOG INPUT READINGS:
>PM                1.2 mg/m3
FLOW               16.67 LPM
SAMPLE RH          42 %
MASS               279 ug
IO5                0.0 V↓

RANGE  AVG  DIAGS  ALARM
  
```

### Analog Input Voltages

The Analog Input Voltages screen (read only) displays the 8 raw analog voltage readings (if the I/O expansion board option is installed).

- In the Main Menu, choose Diagnostics > **Analog Input Voltages**.

```
ANALOG INPUT VOLTAGES:
>ANALOG IN 1      6.24 V
ANALOG IN 2      4.28 V
ANALOG IN 3      0.00 V
ANALOG IN 4      0.00 V
ANALOG IN 5      0.00 V↓
RANGE  AVG  DIAGS  ALARM
```

## Digital Inputs


The Digital Inputs screen (read only) displays the state of the 16 digital inputs. Pull-ups are provided on all of the inputs, so if nothing they will read (1), if an input is brought to ground, it will read (0).

- In the Main Menu, choose Diagnostics > **Digital Inputs**.

```
DIGITAL INPUTS:
>INPUT 1          1
INPUT 2          1
INPUT 3          1
INPUT 4          1
INPUT 5          1↓
RANGE  AVG  DIAGS  ALARM
```

## Relay States

The Relay States screen displays the state of the 10 digital outputs and allows toggling of the state to either on (1) or off (0). The relays are restored to their original states upon exiting this screen.

- In the Main Menu, choose Diagnostics > **Relay States**.
- Press  to toggle and set the relay state to open or closed for the selected digital output.

```
RELAY STATE:
>OUTPUT 1        0
OUTPUT 2        0
OUTPUT 3        0
OUTPUT 4        1
OUTPUT 5        1↓
RANGE  AVG  DIAGS  ALARM
```

## Test Analog Outputs

The Test Analog Outputs menu is used to set each of the analog output channels to zero or full-scale. Channel choices include all analog outputs, 6 voltage channels, and 6 current channels (if the I/O expansion board option is installed).

- In the Main Menu, choose Diagnostics > **Test Analog Outputs**.

```

TEST ANALOG OUTPUTS:
>ALL
VOLTAGE CHANNEL 1
VOLTAGE CHANNEL 2
VOLTAGE CHANNEL 3
VOLTAGE CHANNEL 4

RANGE  AVG  DIAGS  ALARM
  
```

### Set Analog Outputs

The Set Analog Outputs screen contains three choices: Set to full-scale, set to zero, or reset to normal. Full-scale sets the analog outputs to the full-scale voltage, zero sets the analog outputs to 0 volts, and reset returns the output to normal operation. The analog outputs are returned to normal operation upon exiting this screen. The following example shows the screen when all analog outputs are set to “normal” operating mode.

- In the Main Menu, choose Diagnostics > Test Analog Outputs > **ALL**, **Voltage Channel 1–6**, or **Current Channel 1–6**.


```

SET ANALOG OUTPUTS:
SETTING:                ALL
OUTPUT SET TO:         NORMAL
↑ SET TO FULL SCALE
↓ SET TO ZERO
← RESET TO NORMAL

RANGE  AVG  DIAGS  ALARM
  
```

### Instrument Configuration

The Instrument Configuration screen displays information on the hardware configuration of the instrument.

**Note** If the analyzer is in service mode, pressing  will toggle the selected item between yes and no. ▲

- In the Main Menu, choose Diagnostics > **Instrument Configuration**.

```

INSTRUMENT CONFIGURATION:
>I/O EXPANSION BOARD YES
DETECTOR                BETA
DETECTOR B              NONE

↑↓ CHANGE VALUE      ← SAVE

RANGE  AVG  DIAGS  ALARM
  
```

## Contact Information

The Contact Information screen displays the customer service information.


- In the Main Menu, choose Diagnostics > **Contact Information**.

```
CONTACT INFORMATION:
CALL CENTER: 508-520-0430
http://WWW.THERMO.COM/AQI
RANGE  AVG  DIAGS  ALARM
```

## Alarms Menu

The alarms menu allows the user to view a set of alarms for different boards and displays a list of items that are monitored by the analyzer. The number of alarms detected is displayed to indicate how many alarms have occurred. If no alarms are detected, the number zero is displayed.

If the item being monitored goes outside the lower or upper limit, the status of that item will go from “OK” to either “LOW” or “HIGH”, respectively. If the alarm is not a level alarm, the status will go from “OK” to “FAIL”. The number of alarms detected is displayed to indicate how many alarms have occurred. If no alarms are detected, the number zero is displayed.

Items displayed are determined by the options installed. To see the actual reading of an item and its minimum and maximum limits, move the cursor to the item and press . If the readings go beyond either the minimum or maximum limit, an alarm is activated and the alarm (bell) icon appears in the status bar on the Run screen and in the Main Menu.

If any alarms are active, the alarm (bell) icon is displayed on the right side of the status bar.

- In the Main Menu, choose **Alarms**.

```
ALARMS:
ALARMS DETECTED           0
>INSTRUMENT ALARMS       0
DETECTOR ALARMS          0
RH/TEMPERATURE ALARMS    0
PRESSURE/VACUUM ALARMS   0↓
RANGE  AVG  DIAGS  ALARM
FLOW ALARMS               0
CONC ALARMS               0
```



## Instrument Alarms

The Instrument Alarms submenu allows the user to view a set of alarms for different boards. The filter tape change, heater power, and bench items (motherboard, interface board and I/O expansion board) are read only. The motherboard status, interface board status, and I/O expansion board status (if installed) indicate that the power supplies are working and connections are successful. There are no setting screens for these alarms.

- In the Main Menu, choose Alarms > **Instrument Alarms**.

```

INSTRUMENT ALARMS:
>FILTER TAPE COUNTER      OK
  FILTER TAPE CHANGE      OK
  BENCH                    OK
  HEATER POWER            OK
  MOTHERBOARD STATUS      OK↓
RANGE  AVG  DIAGS  ALARM

INTERFACE STATUS          OK
I/O EXP STATUS             OK
  
```

## Filter Tape Counter

The Filter Tape Counter screen displays the current filter tape counter value and sets the maximum alarm limit. If the filter tape counter reading goes beyond the maximum limit, an alarm is activated and the alarm (bell) icon appears in the status bar on the Run screen and in the Main Menu.

- In the Main Menu, choose Alarms > Instrument Alarms > **Filter Tape Counter**.

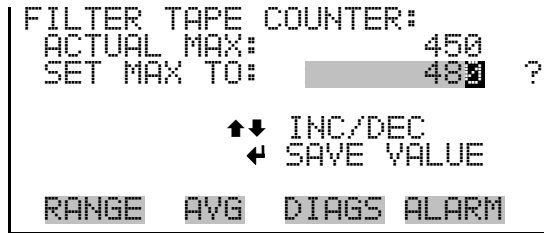
```

FILTER TAPE COUNTER:
  ACTUAL                0
  >MAX                  450
RANGE  AVG  DIAGS  ALARM
  
```

## Max Filter Tape Counter

The Maximum Filter Tape Counter screen is used to change the maximum filter tape counter alarm limit (480 = 90% usage, 10% remaining).

- In the Main Menu, choose Alarms > Instrument Alarms > Filter Tape Counter > **Max**.



## Detector Alarms

The Detector Alarms submenu allows the user to view a set of alarms for detector boards. Board status indicates that the power supplies are working and connections are successful. There are no setting screens for this alarm.

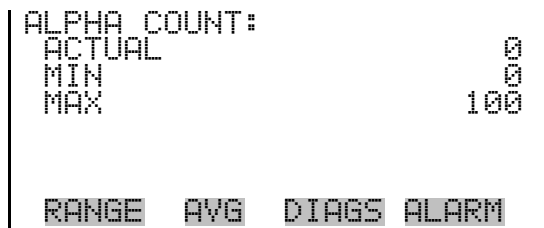
- In the Main Menu, choose Alarms > **Detector Alarms**.



## Min and Max Alpha Alarms

The Alpha Alarms screen allows the user to view the minimum and maximum alarm parameters. Acceptable alarm limits range from 0 to 100. If the alpha count reading goes beyond the maximum limit, an alarm is activated and the alarm (bell) icon appears in the status bar on the Run screen and in the Main Menu.

- In the Main Menu, choose Alarms > Detector Alarms > **Alpha**.



## Min and Max Beta Alarms

The Beta Alarms screen allows the user to view the minimum and maximum alarm parameters. Acceptable alarm limits range from 5000 to 20000. If the beta count reading goes beyond the maximum limit, an alarm is activated and the alarm (bell) icon appears in the status bar on the Run screen and in the Main Menu.

- In the Main Menu, choose Alarms > Detector Alarms > **Beta**.

```

BETA COUNT:
ACTUAL                0
MIN                   5000
MAX                   20000

RANGE  AVG  DIAGS  ALARM
  
```

## RH/Temperature Alarms

The RH/Temperature Alarms submenu allows the user to view and set the relative humidity or temperature alarm parameters.

- In the Main Menu, choose Alarms > **RH/Temperature Alarms**.

```

RH/TEMPERATURE ALARMS:
>AMBIENT RH          OK
SAMPLE RH            OK
AMBIENT TEMP         OK
FLOW TEMP            OK
BOARD TEMP           OK↓

RANGE  AVG  DIAGS  ALARM
  
```

## Ambient RH

The Ambient RH screen displays the current ambient relative humidity value and sets the minimum and maximum alarm limits. Acceptable alarm limits range from 5 to 95%. If the ambient RH reading goes beyond the minimum or maximum limit, an alarm is activated and the alarm (bell) icon appears in the status bar on the Run screen and in the Main Menu.

- In the Main Menu, choose Alarms > RH/Temperature Alarms > **Ambient RH**.

```

AMBIENT RH:
ACTUAL                27.4  %
>MIN                  5.0  %
MAX                   95.0  %

RANGE  AVG  DIAGS  ALARM
  
```

## Min and Max Ambient RH Limits

The Minimum Ambient RH alarm limit screen is used to change the minimum ambient RH alarm limit. The minimum and maximum ambient RH screens function the same way.

- In the Main Menu, choose Alarms > RH/Temperature Alarms > Ambient RH > **Min** or **Max**.

```
RELATIVE HUMIDITY:
ACTUAL MIN:      5.0 %
SET MIN TO:     5.5 %?

      ↑↓ INC/DEC
      ← SAVE VALUE

RANGE  AVG  DIAGS  ALARM
```

### Sample RH

The Sample RH screen displays the current sample relative humidity value and sets the minimum and maximum alarm limits. Acceptable alarm limits range from 5 to 95%. If the sample RH reading goes beyond the minimum or maximum limit, an alarm is activated and the alarm (bell) icon appears in the status bar on the Run screen and in the Main Menu.

- In the Main Menu, choose Alarms > RH/Temperature Alarms > **Sample RH**.

```
SAMPLE RH:
ACTUAL      0.0 %
>MIN      5.0 %
MAX      95.0 %

RANGE  AVG  DIAGS  ALARM
```

### Min and Max Sample RH Limits

The Minimum Sample RH alarm limit screen is used to change the minimum ambient RH alarm limit. The minimum and maximum sample RH screens function the same way.

- In the Main Menu, choose Alarms > RH/Temperature Alarms > Sample RH > **Min** or **Max**.

```
SAMPLE RH:
ACTUAL MIN:      5.0 %
SET MIN TO:     35 %?

      ↑↓ INC/DEC
      ← SAVE VALUE

RANGE  AVG  DIAGS  ALARM
```

## Ambient Temperature

The Ambient Temperature screen displays the current ambient temperature value and sets the minimum and maximum alarm limits. Acceptable alarm limits range from -30 °C to 60 °C. If the ambient temperature reading goes beyond the minimum or maximum limit, an alarm is activated and the alarm (bell) icon appears in the status bar on the Run screen and in the Main Menu.

- In the Main Menu, choose Alarms > RH/Temperature Alarms > **Ambient Temp.**

```

AMBIENT TEMP:
  ACTUAL          -30.0 °C
 >MIN             -30.0 °C
  MAX             60.0 °C

RANGE  AVG  DIAGS  ALARM
  
```

## Min and Max Ambient Temperature Limits

The Minimum Ambient Temperature alarm limit screen is used to change the minimum ambient temperature alarm limit. The minimum and maximum ambient temperature screens function the same way.

- In the Main Menu, choose Alarms > RH/Temperature Alarms > Ambient Temp > **Min** or **Max**.

```

AMBIENT TEMPERATURE:
  ACTUAL MIN:     -30.0 °C
  SET MIN TO:    -20.0 °C?

      ↑↓ INC/DEC
      ← SAVE VALUE

RANGE  AVG  DIAGS  ALARM
  
```

## Flow Temperature

The Flow Temperature screen displays the current ambient temperature value and sets the minimum and maximum alarm limits. Acceptable alarm limits range from 5 to 60 °C. If the flow temperature reading goes beyond the minimum or maximum limit, an alarm is activated and the alarm (bell) icon appears in the status bar on the Run screen and in the Main Menu.

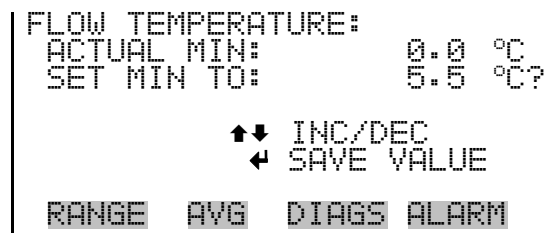
- In the Main Menu, choose Alarms > RH/Temperature Alarms > **Flow Temp.**



### Min and Max Flow Temperature Limits

The Minimum Flow Temperature alarm limit screen is used to change the minimum flow temperature alarm limit. The minimum and maximum flow temperature screens function the same way.

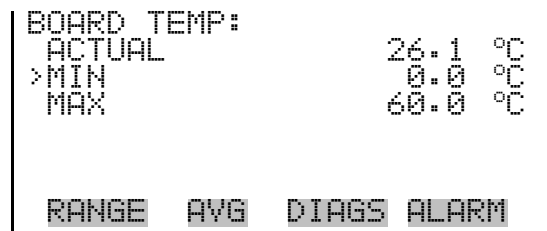
- In the Main Menu, choose Alarms > RH/Temperature Alarms > Flow Temp > **Min** or **Max**.



### Board Temperature

The Board Temperature screen displays the current board temperature value and sets the minimum and maximum alarm limits. Acceptable alarm limits range from 5 to 60 °C. If the board temperature reading goes beyond the minimum or maximum limit, an alarm is activated and the alarm (bell) icon appears in the status bar on the Run screen and in the Main Menu.

- In the Main Menu, choose Alarms > RH/Temperature Alarms > **Board Temp**.



### Min and Max Board Temperature Limits

The Minimum Board Temperature alarm limit screen is used to change the minimum board temperature alarm limit. The minimum and maximum board temperature screens function the same way.

- In the Main Menu, choose Alarms > RH/Temperature Alarms > Board Temp > **Min** or **Max**.

```

BOARD TEMPERATURE:
ACTUAL MIN:      5.0 °C
SET MIN TO:     0.0 °C?

      ↑↓ INC/DEC
      ← SAVE VALUE

RANGE  AVG  DIAGS  ALARM
  
```

## Pressure/Vacuum Alarms

The Pressure/Vacuum Alarms submenu allows the user to view and set the pressure alarm parameters.

- In the Main Menu, choose Alarms > **Pressure/Vacuum Alarms**.

```

PRESSURE/VACUUM ALARMS:
>BARO PRES      OK
VACUUM          OK
FLOW            OK

RANGE  AVG  DIAGS  ALARM
  
```

## Barometric Pressure

The Barometric Pressure screen displays the current pressure reading and sets the minimum and maximum alarm limits. Acceptable alarm limits range from 400 to 800 mmHg. If the barometric pressure reading goes beyond the minimum or maximum limit, an alarm is activated and the alarm (bell) icon appears in the status bar on the Run screen and in the Main Menu.

- In the Main Menu, choose Alarms > Pressure/Vacuum Alarms > **Baro Pres**.

```

BAROMETRIC PRESSURE:
ACTUAL          764.0 mmHg
>MIN           400.0 mmHg
MAX            800.0 mmHg

RANGE  AVG  DIAGS  ALARM
  
```

### Min and Max Barometric Pressure Limits

The Minimum Barometric Pressure alarm limit screen is used to change the minimum barometric pressure alarm limit. The minimum and maximum barometric pressure screens function the same way.

- In the Main Menu, choose Alarms > Pressure/Vacuum Alarms > Baro Pres > **Min** or **Max**.

```
BAROMETRIC PRESSURE:
ACTUAL MIN:    400.0 mmHg
SET MIN TO:   400.1 mmHg?

      ↑↓ INC/DEC
      ← SAVE VALUE

RANGE  AVG  DIAGS  ALARM
```

### Vacuum

The Vacuum screen displays the current vacuum reading and sets the minimum and maximum alarm limits. Acceptable alarm limits range from -5 mmHg to 250 mmHg. If the vacuum reading goes beyond the minimum or maximum limit, an alarm is activated and the alarm (bell) icon appears in the status bar on the Run screen and in the Main Menu.

- In the Main Menu, choose Alarms > Pressure/Vacuum Alarms > **Vacuum**.

```
VACUUM:
ACTUAL          60.8 mmHg
>MIN           -5.0 mmHg
MAX            250.0 mmHg

RANGE  AVG  DIAGS  ALARM
```

### Min and Max Vacuum Limits

The Minimum Vacuum alarm limit screen is used to change the minimum vacuum alarm limit. The minimum and maximum vacuum screens function the same way.

**Note** The maximum vacuum value should not be changes, as this is also used as a protective feature for the instrument. ▲

- In the Main Menu, choose Alarms > Pressure/Vacuum Alarms > Vacuum > **Min** or **Max**.



```

VACUUM:
ACTUAL MIN:      -5.0 mmHg
SET MIN TO:     -4.9 mmHg?

      ↑↓ INC/DEC
      ← SAVE VALUE

RANGE  AVG  DIAGS  ALARM
  
```

**Flow** The Flow screen displays the current flow reading and sets the minimum and maximum alarm limits. Acceptable alarm limits range from -5 mmHg to 40 mmHg. If the flow reading goes beyond the minimum or maximum limit, an alarm is activated and the alarm (bell) icon appears in the status bar on the Run screen and in the Main Menu.

- In the Main Menu, choose Alarms > Pressure/Vacuum Alarms > **Flow**.

```

FLOW:
ACTUAL          23.1 mmHg
>MIN            -5.0 mmHg
MAX             40.0 mmHg

RANGE  AVG  DIAGS  ALARM
  
```

### Min and Max Flow Limits

The Minimum Flow alarm limit screen is used to change the minimum flow alarm limit. The minimum and maximum flow screens function the same way.

- In the Main Menu, choose Alarms > Pressure/Vacuum Alarms > Flow > **Min** or **Max**.

```

FLOW PRESSURE:
ACTUAL MIN:      -5.0 mmHg
SET MIN TO:     -4.9 mmHg?

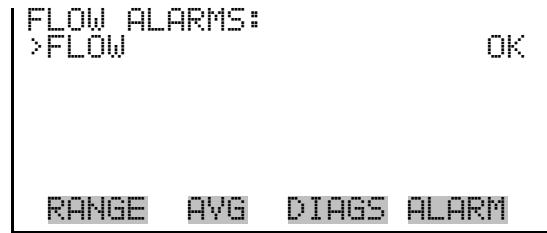
      ↑↓ INC/DEC
      ← SAVE VALUE

RANGE  AVG  DIAGS  ALARM
  
```

### Flow Alarms

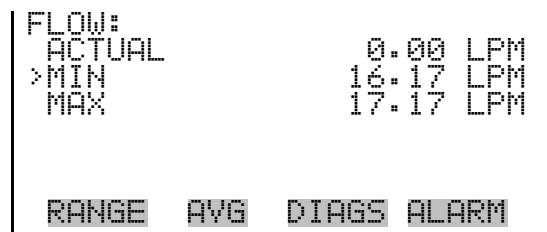
The Flow Alarms submenu allows the user to view and set the flow alarm parameters.

- In the Main Menu, choose Alarms > **Flow Alarms**.



**Flow** The Flow screen displays the current flow and sets the minimum and maximum alarm limits. Acceptable alarm limits range from 16.00 to 17.34 LPM. If the flow reading goes beyond the minimum or maximum limit, an alarm is activated and the alarm (bell) icon appears in the status bar on the Run screen and in the Main Menu.

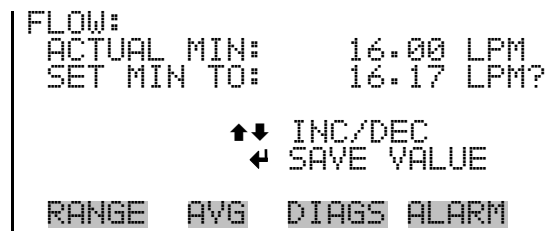
- In the Main Menu, choose Alarms > Flow Alarms > **Flow**.



### Min and Max Flow Limits

The Minimum Flow alarm limit screen is used to change the minimum flow alarm limit. The minimum and maximum flow screens function the same way.

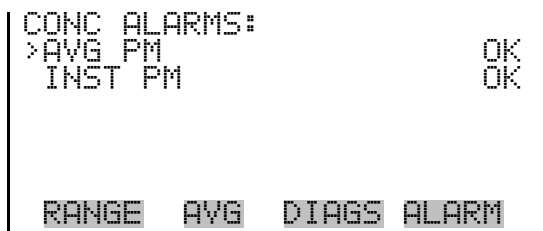
- In the Main Menu, choose Alarms > Flow Alarms > Flow > **Min** or **Max**.



### Concentration Alarms

The Concentration Alarms submenu allows the user to view and set the 24-hour average PM and instant PM concentration alarm parameters.

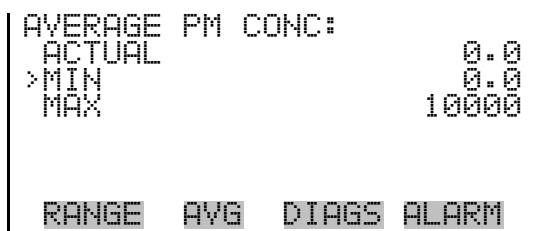
- In the Main Menu, choose Alarms > **Conc Alarms**.



### Average PM

The Average PM screen displays the current average PM concentration and sets the minimum and maximum alarm limits. Acceptable alarm limits range from 0 to 10000  $\mu\text{g}/\text{m}^3$  or 0 to 10  $\text{mg}/\text{m}^3$ . If the average PM concentration goes beyond either the minimum or maximum limit, an alarm is activated and the alarm (bell) icon appears in the status bar on the Run screen and in the Main Menu.

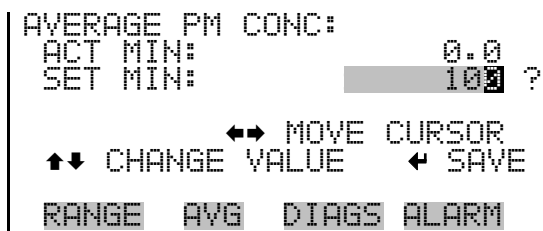
- In the Main Menu, choose Alarms > Conc Alarms > **Avg PM**.



### Min and Max Average PM Concentration Limits

The Minimum Average PM Concentration alarm limit screen is used to change the minimum average PM concentration alarm limit. The minimum and maximum average PM concentration screens function the same way.

- In the Main Menu, choose Alarms > Conc Alarms > Avg PM > **Min** or **Max**.



### Instant PM

The Instant PM screen displays the current instant PM concentration and sets the minimum and maximum alarm limits. Acceptable alarm limits

range from -10 to 10000  $\mu\text{g}/\text{m}^3$  or -.01 to 10  $\text{mg}/\text{m}^3$ . If the instant PM concentration goes beyond either the minimum or maximum limit, an alarm is activated and the alarm (bell) icon appears in the status bar on the Run screen and in the Main Menu.

- In the Main Menu, choose Alarms > Conc Alarms > **Inst PM**.

```
INSTANT PM CONC:
ACTUAL           0.0
>MIN            -10.0
MAX             10000

RANGE  AVG  DIAGS  ALARM
```

### Min and Max Instant PM Concentration Limits

The Minimum Instant PM Concentration alarm limit screen is used to change the minimum instant PM concentration alarm limit. The minimum and maximum instant PM concentration screens function the same way.

- In the Main Menu, choose Alarms > Conc Alarms > Inst PM > **Min** or **Max**.

```
INSTANT PM CONC:
ACT MIN:         0.0
SET MIN:         -10.0 ?

      ←→ MOVE CURSOR
↑↓ CHANGE VALUE  ← SAVE

RANGE  AVG  DIAGS  ALARM
```

### Service Menu

The Service menu appears only when the instrument is in the service mode. When the service mode is active, the service (wrench) icon is displayed on the right side of the status bar. To put the instrument into the service mode:

- In the Main Menu, choose Instrument Controls > **Service Mode**.

Advanced diagnostic functions are included in the service mode. Meaningful data should not be collected when the instrument is in the service mode.

- In the Main Menu, choose **Service**.

```

SERVICE:
>RH/TEMP CALIBRATION
PRES/VACUUM CALIBRATION
FLOW CALIBRATION
MASS CALIBRATION
DETECTOR CALIBRATION
RANGE  AVG  DIAGS  ALARM
ANALOG OUT CALIBRATION
ANALOG INPUT CALIBRATION
DISPLAY PIXEL TEST
RESTORE USER DEFAULTS
RESTORE FACTORY DEFAULTS

```

## RH/Temperature Calibration

The RH/Temperature Calibration submenu allows the user to view and set the relative humidity and temperature sensor calibration. The RH/temperature calibration submenu is visible only when the instrument is in service mode. For more information on the service mode, see “[Service Mode](#)” earlier in this chapter.

**Note** This adjustment should only be performed by an instrument service technician. ▲

- In the Main Menu, choose Service > **RH/Temp Calibration**.

```

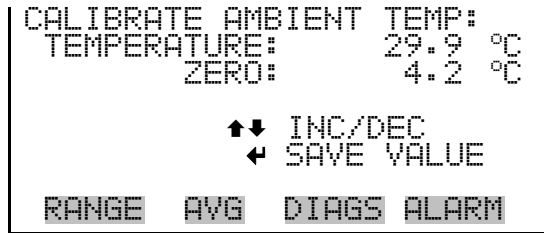
RH/TEMP CALIBRATION:
>AMBIENT TEMP      4.2 °C
FLOW TEMP          0.8 °C
AMBIENT RH         0.0 %
RANGE  AVG  DIAGS  ALARM

```

## Ambient Temperature

The Ambient Temperature screen allows the user to view and calibrate ambient temperature. Adjust the zero offset until the ambient temperature agrees with your traceable standard.

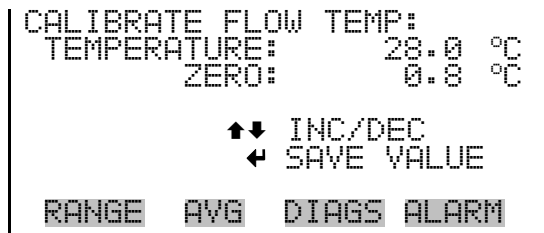
- In the Main Menu, choose Service > RH/Temp Calibration > **Ambient Temp**.



### Flow Temperature

The Flow Temperature screen allows the user to view and calibrate flow temperature. Be sure to have the cover removed and equilibrated to room temperature.

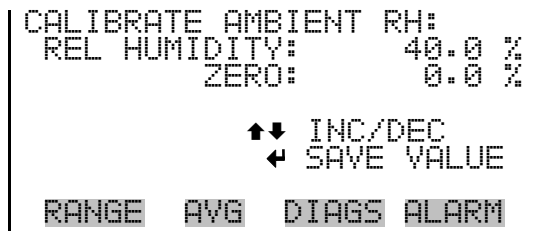
- In the Main Menu, choose Service > RH/Temp Calibration > **Flow Temp.**



### Ambient Relative Humidity

The Ambient Relative Humidity screen allows the user to view and calibrate relative humidity. Adjust the zero offset until the RH agrees with your traceable standard.

- In the Main Menu, choose Service > RH/Temp Calibration > **Ambient RH.**



### Pressure/Vacuum Calibration

The Pressure/Vacuum Calibration submenu allows the user to view and calibrate the pressure sensor and vacuum flow sensor. The pressure/vacuum calibration submenu is visible only when the instrument is in service mode. For more information on the service mode, see “[Service Mode](#)” earlier in this chapter.

**Note** This adjustment should only be performed by an instrument service technician. ▲

- In the Main Menu, choose Service > **Pres/Vacuum Calibration**.

```
PRES/VACUUM CALIBRATION:
>BARO PRES
VAC/FLOW

RANGE  AVG  DIAGS  ALARM
```

### Barometer Pressure Calibration

The Barometer Pressure Calibration submenu is used to calibrate the barometer pressure span or reset default values.

- In the Main Menu, choose Service > Pres/Vacuum Calibration > **Baro Pres**.

```
BARO PRES CALIBRATION:
>SPAN 1.0000
SET DEFAULTS

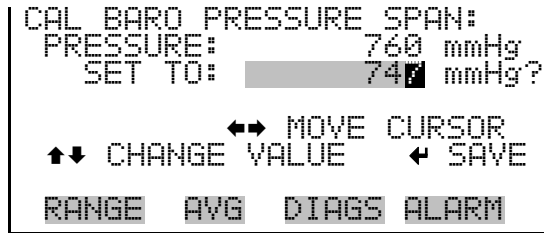
RANGE  AVG  DIAGS  ALARM
```

### Calibrate Barometer Pressure Span

The Calibrate Barometer Pressure Span screen allows the user to view and pressure sensor calibration span point.

**Note** The operator should use an independent barometer to measure the ambient pressure and enter the value on this screen before calibrating. ▲

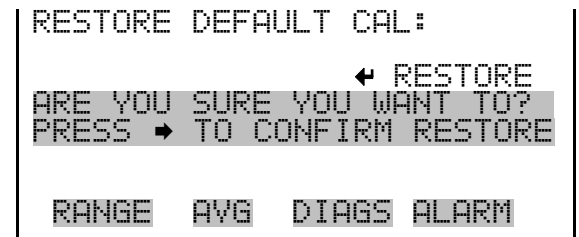
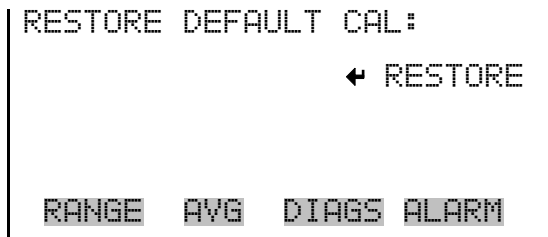
- In the Main Menu, choose Service > Pres/Vacuum Calibration > Baro Pres Calibration > **Span**.



**Restore Default Calibration**

The Restore Default Calibration screen allows the user to reset the default values.

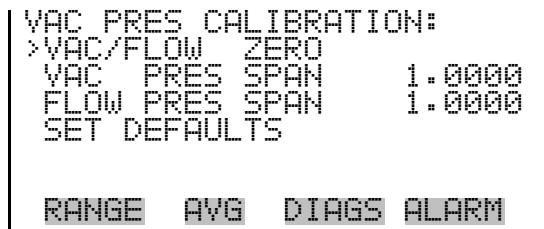
- In the Main Menu, choose Service > Pres/Vacuum Calibration > Baro Pres Calibration > Set Defaults.



**Vacuum/Flow Calibration**

The Vacuum/Flow Calibration submenu is used to calibrate the vacuum/flow zero, vacuum/flow span, or reset default values.

- In the Main Menu, choose Service > Pres/Vacuum Calibration > Vac/Flow.

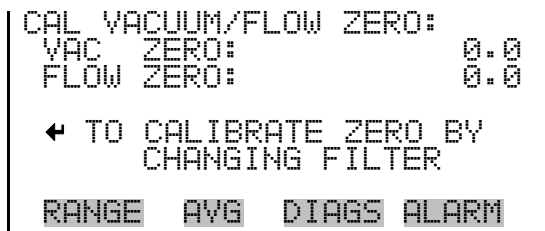


**Calibrate Vacuum/Flow Zero**

The Calibrate Vacuum/Flow Zero screen calibrates the vacuum/flow sensor at zero value.

- In the Main Menu, choose Service > Pres/Vacuum Calibration > Vac/Flow > Vac/Flow Zero.



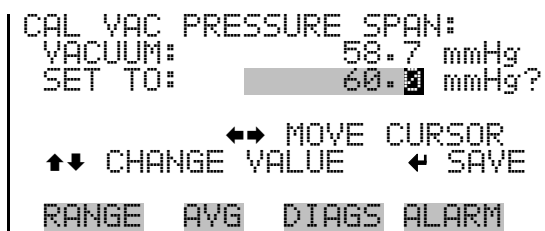


### Calibrate Vacuum Pressure Span

The Calibrate Vacuum Pressure Span screen allows the user to view and set the flow sensor calibration span point.

**Note** The operator should use an independent manometer capable of measuring approximately 100 mmHg of vacuum. Measure the vacuum under the filter tape from the positive  $\Delta P$  port on the rear panel of the instrument and enter the value on this screen before calibrating. ▲

- In the Main Menu, choose Service > Pres/Vacuum Calibration > Vac/Flow > **Vac Pres Span**.

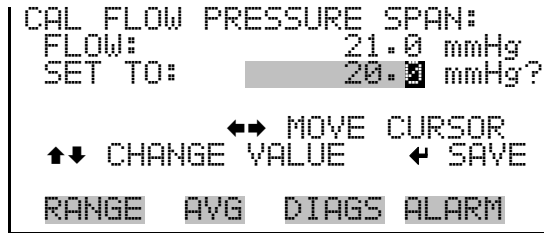


### Calibrate Flow Pressure Span

The Flow Pressure Span screen allows the user to view and set the flow sensor calibration span point.

**Note** The operator should use an independent manometer, capable of 30 mmHg  $\Delta P$ , to measure the differential pressure across the orifice using the positive and negative  $\Delta P$  ports on the rear panel, and enter the value on this screen before calibrating. ▲

- In the Main Menu, choose Service > Pres/Vacuum Calibration > Vac/Flow > **Flow Pres Span**.

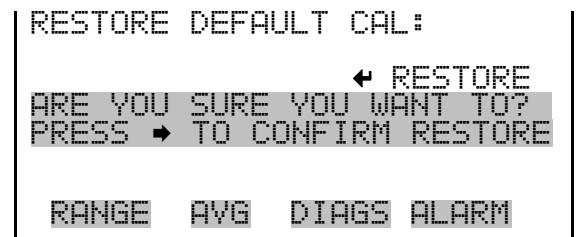
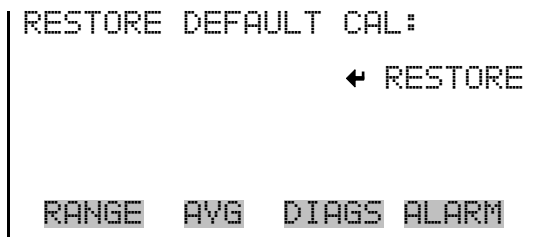


### Restore Default Calibration

The Restore Default Calibration screen allows the user to reset the default values.

**Note** Be sure to close the toggle switch after calibration is complete. ▲

- In the Main Menu, choose Service > Pres/Vacuum Calibration > Vac/Flow > Set Defaults.

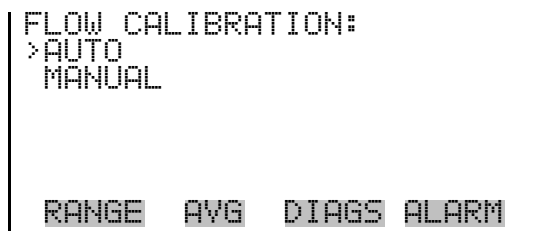


### Flow Calibration

The Flow Calibration submenu is used to view and set the flow calibration flow point. The flow calibration screen is visible only when the instrument is in service mode. For more information on the service mode, see “[Service Mode](#)” earlier in the chapter.

**Note** This adjustment should only be performed by an instrument service technician. ▲

- In the Main Menu, choose Service > **Flow Calibration**.



### Auto Flow Calibration

The Auto Flow Calibration screen allows the user to view and set the correct flow rate. The span value is automatically calculated.

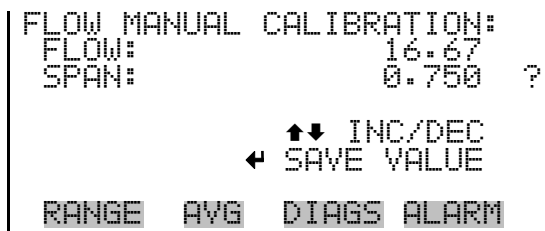
- In the Main Menu, choose Service > Flow Calibration > **Auto**.



### Manual Flow Calibration

The Manual Flow Calibration screen allows the user to view and incrementally set the flow sensor calibration span factor.

- In the Main Menu, choose Service > Flow Calibration > **Manual**.

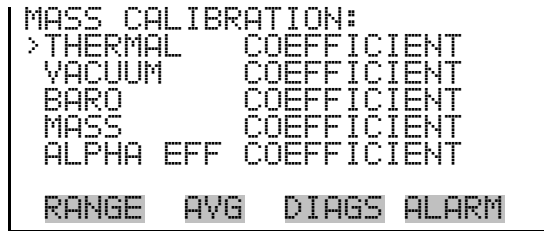


### Mass Calibration

The Mass Calibration submenu is used to view and set the mass calibration point. The mass calibration screen is visible only when the instrument is in service mode. For more information on the service mode, see “[Service Mode](#)” earlier in the chapter.

**Note** This adjustment should only be performed by an instrument service technician. ▲

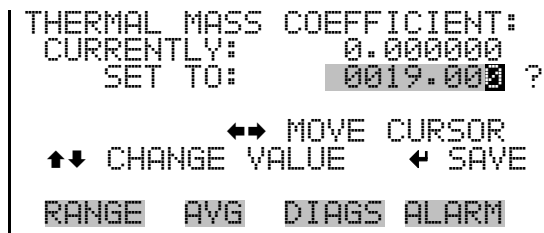
- In the Main Menu, choose Service > **Mass Calibration**.



### Thermal Mass Coefficient

The Thermal Mass Coefficient screen allows the user to view and set the thermal coefficient using manual calibration mode.

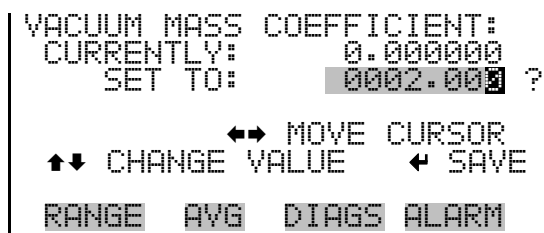
- In the Main Menu, choose Service > Mass Calibration > **Thermal Coefficient**.



### Vacuum Mass Coefficient

The Vacuum Mass coefficient screen allows the user to view and set the vacuum coefficient using manual calibration mode.

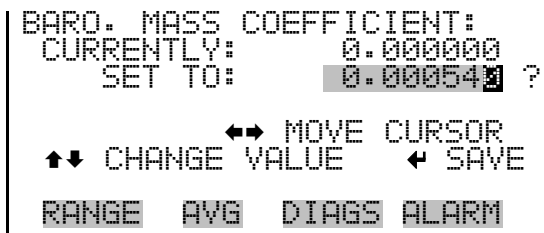
- In the Main Menu, choose Service > Mass Calibration > **Vacuum Coefficient**.



### Barometer Mass Coefficient

The Barometer Mass Coefficient screen allows the user to view and set the barometer coefficient using manual calibration mode.

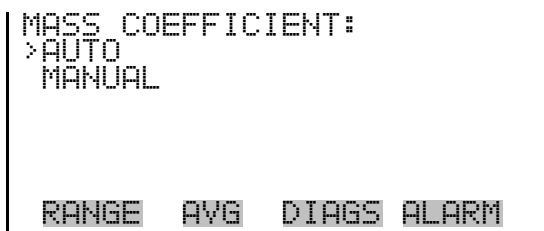
- In the Main Menu, choose Service > Mass Calibration > **Baro Coefficient**.



### Mass Coefficient


The Mass Coefficient submenu allows the user to view and set the mass coefficient using manual or auto mode.

- In the Main Menu, choose Service > Mass Calibration > **Mass Coefficient**.

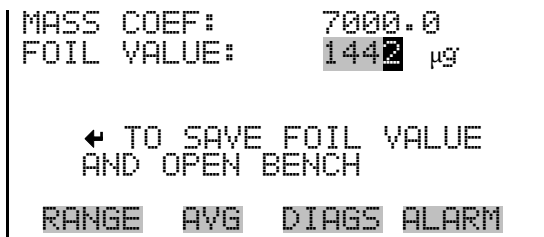


### Auto Mass Coefficient

The Auto Mass Coefficient screen allows the user to conduct a mass foil calibration.

**Note** After pressing  a series of screens will walk you through the mass foil calibration procedure. For details, see “Auto Mass Coefficient” on page 4-9. ▲

- In the Main Menu, choose Service > Mass Calibration > Mass > **Auto**.



### Manual Mass Coefficient

The Manual Mass Coefficient screen allows the user to adjust the mass coefficient used in beta attenuation.



```

DETECTOR CALIBRATION:
>AUTO
  MANUAL

RANGE  AVG  DIAGS  ALARM
  
```

### Auto Detector Calibration

The Auto Detector Calibration screen allows the user to conduct a detector optimization routine that will establish the optimal plateau for detector performance. This process takes approximately 30 minutes and will set a high voltage and thresholds for alpha and beta reference counts.

- In the Main Menu, choose Service > Detector Calibration > **Auto**.

```

DETECTOR AUTO CAL:
HIGH VOLT:      1500 V
BETA CNT :     14649 1/sec

PRESS ← TO START AUTO CAL

RANGE  AVG  DIAGS  ALARM
  
```

### Manual Detector Calibration

The Mass Coefficient submenu allows the user to perform a mass foil calibration using a zero (null) and span foil set.

- In the Main Menu, choose Service > Detector Calibration > **Manual**.

```

DETECTOR MANUAL CAL:
>BETA/REF/ALPHA COUNTS
HIGH VOLTAGE
BETA REF THRESHOLD
ALPHA THRESHOLD

RANGE  AVG  DIAGS  ALARM
  
```

### Beta/Ref/Alpha Counts

The Beta/Ref/Alpha Counts screen allows the user to view the real-time alpha and beta counts.

- In the Main Menu, choose Service > Detector Calibration > Manual > **Beta/Ref/Alpha Counts**.

```
COUNTS:
alpha      0 1/sec
beta      10212 1/sec
beta corr 10145 1/sec
beta ref   5200 1/sec

RANGE  AVG  DIAGS  ALARM
```

### High Voltage

The High Voltage screen allows the user to view and set the high voltage value.

- In the Main Menu, choose Service > Detector Calibration > Manual > **High Voltage**.

```
HIGH VOLTAGE:
CURRENTLY:    1500 V
SET TO:       1501 V?

  ↑↓ INC/DEC
  ← SAVE VALUE

RANGE  AVG  DIAGS  ALARM
```

### Beta Ref Threshold

The Beta Ref Threshold screen allows the user to view and set the detector operating voltage manually.

- In the Main Menu, choose Service > Detector Calibration > Manual > **Beta Ref Threshold**.

```
REF BETA THRESHOLD:
CURRENTLY:    500
SET TO:       501 ?

  ↑↓ INC/DEC
  ← SAVE VALUE

RANGE  AVG  DIAGS  ALARM
```

### Alpha Threshold

The Alpha Threshold screen allows the user to view and set the alpha threshold manually.

- In the Main Menu, choose Service > Detector Calibration > Manual > **Alpha Threshold**.



```

ALPHA THRESHOLD:
CURRENTLY:      1500
SET TO:        1501 ?

      ↑↓ INC/DEC
      ← SAVE VALUE

RANGE  AVG  DIAGS  ALARM
  
```

## Analog Output Calibration

The Analog Output Calibration menu provides access to the 6 voltage channels and 6 current channels for calibration. Current channels are visible only if the I/O expansion board is installed. The analog output calibration menu is visible only when the instrument is in service mode. For more information on the service mode, see “[Service Mode](#)” earlier in this chapter.

**Note** This adjustment should only be performed by an instrument service technician. ▲

- In the Main Menu, choose Service > **Analog Out Calibration**.

```

ANALOG OUTPUT CAL:
>VOLTAGE CHANNEL 1
VOLTAGE CHANNEL 2
VOLTAGE CHANNEL 3
VOLTAGE CHANNEL 4
VOLTAGE CHANNEL 5
                                     ↓

RANGE  AVG  DIAGS  ALARM
  
```

```

ANALOG OUTPUT CAL:
>CALIBRATE ZERO
CALIBRATE FULL SCALE

RANGE  AVG  DIAGS  ALARM
  
```

### Analog Output Calibrate Zero

The Analog Output Calibrate Zero screen allows the user to calibrate the zero state of the selected analog output. The operator must connect a volt meter to the output and adjust the output until it reads 0.0 V on the meter for a voltage channel, or either 0 or 4 mA for a current channel (depending on the selected range). See the “set output to:” field on the display.

- In the Main Menu, choose Service > Analog Out Cal > select Channel > **Calibrate Zero**.

```
ANALOG OUTPUT CAL: ZERO
CONNECT METER TO OUTPUT!
SELECTED OUTPUT: V1
SET TO: 100
← SAVE VALUE ↑↓ INC/DEC
SET OUTPUT TO: 0.0 V

RANGE  AVG  DIAGS  ALARM
```

### Analog Output Calibrate Full-Scale

The Analog Output Calibrate Full-Scale screen allows the user to calibrate the full-scale state of the selected analog output. The operator must connect a volt meter to the output and adjust the output until the meter reads the value shown in the “set output to:” field, in either V or mA, depending on the selected output channel.

- In the Main Menu, choose Service > Analog Out Cal > select Channel > **Calibrate Full Scale**.

```
ANALOG OUTPUT CAL: SPAN
CONNECT METER TO OUTPUT!
SELECTED OUTPUT: V1
SET TO: 3397
← SAVE VALUE ↑↓ INC/DEC
SET OUTPUT TO: 10 V

RANGE  AVG  DIAGS  ALARM
```

### Analog Input Calibration

The Analog Input Calibration menu is used to calibrate the 8 analog input channels at both zero and full-scale. The analog input calibration menu is visible only when the I/O expansion board is installed and when the instrument is in service mode. For more information on the service mode, see “[Service Mode](#)” earlier in this chapter.

**Note** This adjustment should only be performed by an instrument service technician. ▲

- In the Main Menu, choose Service > **Analog Input Calibration**.

```

ANALOG INPUT CAL:
>INPUT CHANNEL 1
  INPUT CHANNEL 2
  INPUT CHANNEL 3
  INPUT CHANNEL 4
  INPUT CHANNEL 5
                                     ↓
RANGE  AVG  DIAGS  ALARM
  
```

```

ANALOG INPUT CAL:
>CALIBRATE ZERO
  CALIBRATE FULL SCALE
                                     ↓
RANGE  AVG  DIAGS  ALARM
  
```

### Analog Input Calibrate Zero

The Analog Input Calibrate Zero screen allows the user to calibrate the zero state of the selected analog input.

- In the Main Menu, choose Service > Analog Input Cal > select Channel > **Calibrate Zero**.

```

ANALOG INPUT CAL:    ZERO
DISCONNECT SELECTED INPUT!
SELECTED INPUT:      INPUT 1
CURRENTLY:           0.04 V
← CALIBRATE INPUT TO ZERO
RANGE  AVG  DIAGS  ALARM
  
```

### Analog Input Calibrate Full-Scale

The Analog Input Calibrate Full-Scale screen allows the user to calibrate the full-scale state of the selected analog input.

- In the Main Menu, choose Service > Analog Input Cal > select Channel > **Calibrate Full Scale**. (Hook up a voltage source of 10 V to the analog input channel.)

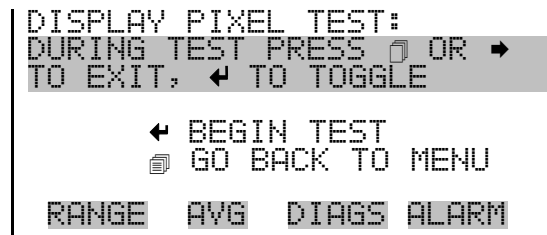
```

ANALOG INPUT CAL:    SPAN
PROVIDE VOLTAGE TO INPUT!
SELECTED INPUT:      INPUT 1
CURRENTLY:           9.84 V
SET TO:              10.00 V
← CALIBRATE TO VALUE
RANGE  AVG  DIAGS  ALARM
  
```

## Display Pixel Test

The Display Pixel Test screen is used to test the LCD display, by toggling between all pixels on and all pixels off to ensure that they are functioning properly. The display pixel test screen is visible only when the instrument is in service mode. For more information on the service mode, see “[Service Mode](#)” earlier in this chapter.

- In the Main Menu, choose Service > **Display Pixel Test**.



## Restore User Defaults

The Restore User Defaults screen is used to reset the user calibration and configuration values to factory defaults. The restore user defaults screen is visible only when the instrument is in service mode. For more information on the service mode, see “[Service Mode](#)” earlier in this chapter.

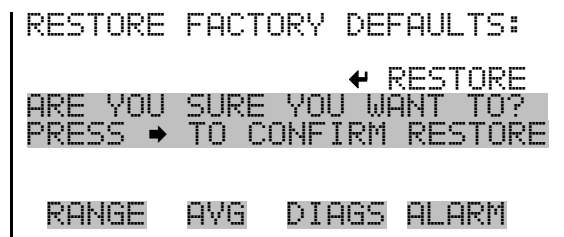
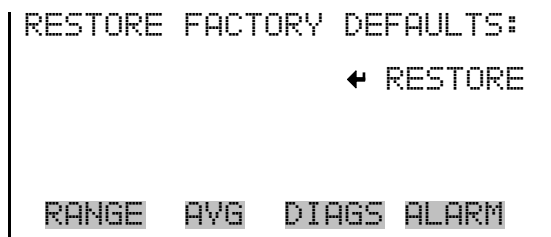
- In the Main Menu, choose Service > **Restore User Defaults**.



## Restore Factory Defaults

The Restore User Defaults screen is used to reset the user calibration and configuration values to factory defaults. The restore user defaults screen is visible only when the instrument is in service mode. For more information on the service mode, see “[Service Mode](#)” earlier in this chapter.

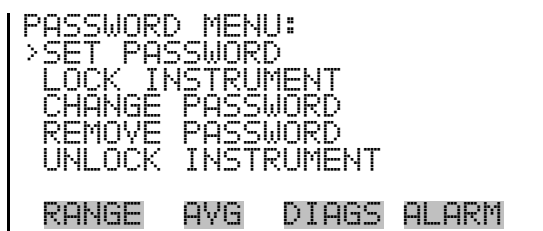
- In the Main Menu, choose Service > **Restore User Defaults**.



## Password Menu

The Password menu allows the user to configure password protection. If the instrument is “locked”, none of the settings may be changed via the front panel user interface, but they can still be changed via remote operation. When the front panel is locked, the user can still navigate the menu and view data, instrument parameters, and settings, but nothing can be changed. The password (lock) icon on the right side of the status bar indicates that the password lock is active. The items visible under the Password menu are determined by the instrument’s password status.

- In the Main Menu, choose **Password**.



## Set Password

The Set Password screen is used to set the password that is used to unlock the front panel, and is shown if the instrument is unlocked and the password is not set.

- In the Main Menu, choose Password > **Set Password**



## Lock Instrument

The Lock Instrument screen is used to lock the instrument's front panel so users cannot change any settings from the front panel. The lock instrument screen is shown if the instrument is unlocked and the password is set.

- In the Main Menu, choose Password > **Lock Instrument**



```
LOCK FRONT PANEL:
PRESSING ENTER WILL
PREVENT USER FROM CHANGING
CONFIG FROM FRONT PANEL
← LOCK AND RETURN TO RUN

RANGE  AVG  DIAGS  ALARM
```

## Lock/Unlock and Local/Remote Operation

If the instrument is locked via the front panel using Password > **Lock Instrument**, the instrument reports being in Remote mode. In this mode, the front panel is “locked”, where data can be viewed, settings can be viewed but not changed using the front panel interface, and the remote “Set” commands are active.

If the instrument keyboard is unlocked via the front panel using Password > **Unlock Instrument**, the instrument reports being in Local mode, the front panel interface is unlocked, and settings can be changed from the front panel.

Refer to “[C-Link Protocol Commands](#)” appendix for detailed information about “mode”, “allow mode”, and “power up mode” commands.

## Change Password

The Change Password screen is used to change the password used to unlock the instrument's front panel. The change password screen is shown if the instrument is unlocked.

- In the Main Menu, choose Password > **Change Password**



```
ENTER NEW PASSWORD:
█
BCDEFGHIJKLMN  BKSP
OPQRSTUVWXYZ   PAGE
0123456789 . / -  SAVE

RANGE  AVG  DIAGS  ALARM
```

## Remove Password

The Remove Password screen is used to erase the current password and disable password protection. The remove password screen is shown if the instrument is unlocked and the password is set.

- In the Main Menu, choose Password > **Remove Password**



## Unlock Instrument

The Unlock Instrument screen is used to enter the password to unlock the front panel. The unlock instrument screen is shown if the instrument is locked.

- In the Main Menu, choose Password > **Unlock Instrument**







# Chapter 4

## Calibration

The Model 5014*i* is an instrument that can make accurate mass concentration measurements of PM<sub>10</sub>, PM<sub>2.5</sub> and PM<sub>1.0</sub>. However, with all electronic instruments, the accuracy of the measurements depends on proper calibration.

In general terms, calibration, also called standardization, is the process that establishes the relationship between sensor output signals and the parameter the operator is attempting to measure. The 5014*i* instrument uses sensors that measure temperature, humidity, pressure, and radiation. This chapter describes the procedures for performing the necessary sensor calibrations. This chapter is also a follow-up to the Acceptance Testing outlined in the “[Installation](#)” chapter and a continuation of the menu display descriptions in the “[Operation](#)” chapter.

### Frequency of Calibration

Each instrument is calibrated and tested for accuracy at the factory. The mass calibration is conducted with a set of NIST-traceable mass calibration foils. The radiation detector is calibrated against certified check sources for beta and alpha emissions. The temperature, relative humidity, pressure and flow rate are all calibrated against NIST traceable standards.

It is recommended that the instrument be calibrated once per year and encounter quality checks on a periodic basis in accordance with the users specific quality assurance project plan. For example, volumetric flow checks on a two-week basis are common in some air monitoring agencies and with full-scale quarterly audits for flow and mass. The *Quality Assurance Handbook for Air Pollution Measurement Systems*, published by the U.S. EPA, Research Triangle Park, NC 27711, can be consulted for detailed quality assurance guidelines.

### Equipment Required

Optional mass transfer standards are available from Thermo Fisher Scientific for performing an annual mass calibration. However, additional specialized equipment is needed to calibrate the Model 5014*i* for temperature, relative humidity, barometric pressure, and volumetric flow. The following equipment should be used:

- A thermistor or thermocouple thermometer capable of measuring ambient temperatures in a range of –20 to 50 °C, readable to the

nearest 0.1 °C. This thermometer should be referenced to within an accuracy of  $\pm 0.5$  °C to NIST-traceable precision thermometers. Multiple thermometers may be used to cover the temperature range as long as each thermometer meets the accuracy and readability specifications described above.

- A barometer capable of measuring barometric pressure over a range of 600 to 800 mmHg (80 to 106 kilo Pascals [kPa]) and readable to the nearest 1 mmHg. At least once a year, this barometer should be calibrated to within  $\pm 5$  mmHg of a NIST-traceable barometer of known accuracy.
- Flow-rate Transfer Standard (FTS) measurement equipment capable of calibrating, or verifying, the volumetric flow rate measurement with an accuracy of  $\pm 2$  percent. This flow rate standard must be a separate, stand-alone device. It must have its own certification and be traceable to a NIST primary standard for volume or flow rate. Dry-piston meters and bubble flow meters should only be used under controlled laboratory conditions. Ambient field measurements should use a NIST-traceable low pressure drop orifice/venturi flow meter (such as, BGI Delta-Cal) or a Streamline Pro™ Model SX Kit (2-25 L/min).
- A relative humidity (RH) standard capable of measuring in the range of 35-75% RH, readable to the nearest 0.5% RH and accurate to within 2% RH.

## Pre-Calibration

Prior to calibration, be sure the Model 5014*i* is operating properly. The Model 5014*i*'s internal diagnostics makes this a quick and simple process. Turn on the instrument and allow it to stabilize for one hour prior to calibrating. If you are receiving this instrument for the first time, the optional acceptance testing in the “[Installation](#)” chapter should also be reviewed. If the internal flow temperature sensor requires calibration, the dynamic heating system should be turned OFF, the cover should be removed, and the instrument should sample room temperature air at least one hour prior to calibrating.

## Calibration Procedure

The order of calibration described below is preferred for optimal performance of the 5014*i* and comes from many years of experience working with and developing ambient particulate monitoring instrumentation. The Calibration submenus allow the user to view and calibrate the instrument. All calibration submenus are visible only when the instrument is in service mode. For more information on the service mode, see “[Service Mode](#)” earlier in Chapter 3.

## RH/Temperature Calibration

All screens that appear in this chapter have been referenced in the previous chapter.

### Ambient Temperature

Using a NIST-traceable thermometer as a reference collocated next to the ambient RH/temperature sensor assembly, measure and compare three individual readings between both the reference and the 5014*i* response. Taking an average of both sets of readings, calculate the average difference between the two readings and record that as your offset. This offset (ZERO) should now be entered in the screen below:

```

CALIBRATE AMBIENT TEMP:
TEMPERATURE:      29.9 °C
ZERO:             4.2 °C

      ↑↓ INC/DEC
      ← SAVE VALUE

RANGE  AVG  DIAGS  ALARM
  
```

Be sure to save the entry and compare the values once more. If it appears that the temperature has shifted into the wrong direction, change the sign of your offset value.

### Ambient Relative Humidity

Using a NIST-traceable hygrometer as a reference collocated next to the ambient RH/temperature sensor assembly, measure and compare three individual readings between both the reference and the 5014*i* response. Taking an average of both sets of readings, calculate the average difference between the two readings and record that as your offset. This offset (ZERO) should now be entered in the screen below:

```

CALIBRATE AMBIENT RH:
REL HUMIDITY:     40.0 %
ZERO:             0.0 %

      ↑↓ INC/DEC
      ← SAVE VALUE

RANGE  AVG  DIAGS  ALARM
  
```

Be sure to save the entry and compare the values once more. If it appears that the temperature has shifted into the wrong direction, change the sign of your offset value.

## Flow Temperature

Assuming the instrument cover has been removed, the heater has been turned off and removed from the instrument and the instrument has been sampling room temperature air for 1-hour, this calibration can now proceed.

Using a NIST-traceable thermometer as a reference collocated next to the small sample tube inlet on top of the instrument, measure and compare three individual readings between both the reference and the 5014*i* response. Taking an average of both sets of readings, calculate the average difference between the two readings and record that as your offset. This offset (ZERO) should now be entered in the screen below:

```
CALIBRATE FLOW TEMP:
TEMPERATURE:      28.0 °C
ZERO:             0.8 °C

  ↑↓ INC/DEC
  ← SAVE VALUE

RANGE  AVG  DIAGS  ALARM
```

Be sure to save the entry and compare the values once more. If it appears that the temperature has shifted into the wrong direction, change the sign of your offset value.

## Pressure/Vacuum Calibration

There are three pressure sensors that can be calibrated, however, the primary sensor to be calibrated is the barometric pressure sensor. Both the vacuum sensor and pressure flow sensors are re-zeroed automatically with every filter tape change.

### Barometer Pressure Calibration

Using a NIST-traceable barometer, measure the barometric pressure (and convert as necessary) in units of millimetres of mercury (mmHg). Use the SPAN feature from the barometric calibration submenu.

```
BARO PRES CALIBRATION:
>SPAN              1.0000
SET DEFAULTS

RANGE  AVG  DIAGS  ALARM
```

```
CAL BARO PRESSURE SPAN:
PRESSURE:      760 mmHg
SET TO:      747 mmHg?

      ←← MOVE CURSOR
↑↓ CHANGE VALUE ← SAVE

RANGE  AVG  DIAGS  ALARM
```

Be sure to save the entry and compare the values once more. Repeat as necessary to within 2 mmHg.

### Calibrate Vacuum/Flow Zero

The Calibrate Vacuum/Flow Zero screen calibrates the vacuum/flow sensor at zero value. This is done automatically with every filter tape change. However, if for any reason this needs to be done, proceed to the following screen below to execute a zeroing filter tape change.

```
CAL VACUUM/FLOW ZERO:
VAC ZERO:      0.0
FLOW ZERO:     0.0

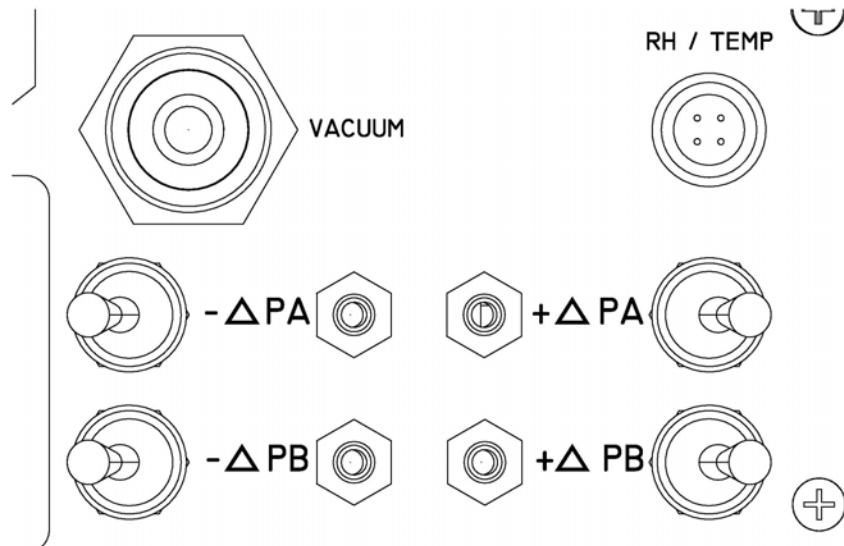
← TO CALIBRATE ZERO BY
  CHANGING FILTER

RANGE  AVG  DIAGS  ALARM
```

### Calibrate Vacuum Pressure Span

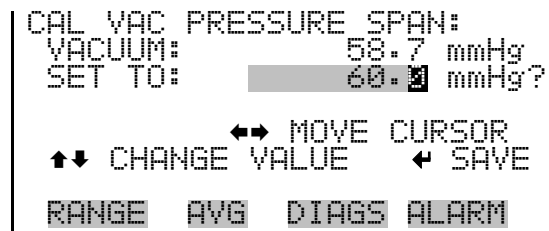
The Calibrate Vacuum Pressure Span screen allows the user to view and set the vacuum sensor calibration span point.

To calibrate the vacuum sensor, zero a digital manometer (capable of measuring up to 100 mmHg) to the + $\Delta$ P port on the rear panel. Then push the toggle switch on the right inward to open (see [Figure 4-1](#)). The manometer reading can now be used to calibrate the vacuum sensor.



**Figure 4-1.** Differential Pressure and Vacuum Calibration Ports

- In the Main Menu, choose Service > Pres/Vacuum Calibration > Vac/Flow > **Vac Pres Span.**

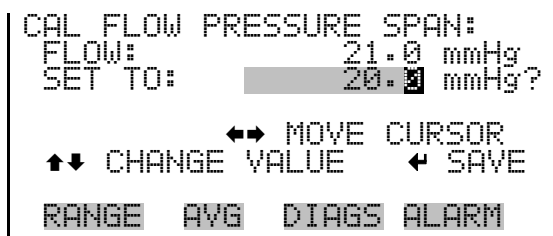


### **Calibrate Flow Pressure Span**

The Flow Pressure Span screen allows the user to view and set the flow sensor calibration span point.

To calibrate the flow pressure sensor span point, the instrument must be pulling an active flow through the filter tape. By use of a manometer, connect the respective +/- ports of your NIST-traceable manometer to the respective rear panel +/- ports. (Please be certain to zero any digital manometers prior to connecting!) Open the ports by pressing the toggle switches inward. Calculate an average reading from the reference manometer in units of mmHg. Enter this span value into the screen below:

- In the Main Menu, choose Service > Pres/Vacuum Calibration > Vac/Flow > **Flow Pres Span**.



Be sure to save the entry and compare the values once more. Repeat as necessary to within 2 mmHg.

## Flow Calibration

The preferred method of flow rate calibration is the Auto Flow Calibration.

### Auto Flow Calibration

Place a NIST-traceable volumetric flow meter on top of the instrument after complete installation (reassembled heater tube, sample tubes, and inlets). Allow approximately 1-minute for the flow to stabilize. Once stable, measure and average three individual readings from the reference. This average observed flow rate from your reference meter should now be entered in the screen below:



Be sure to save the entry and compare the values once more. Repeat as necessary to within +/- 2 %.

Perform the “[Leak Test](#)” procedure on page 5-6 to verify no leaks.

## Mass Calibration

The Model 5014*i* Beta is calibrated for mass in the factory using a series of null and span foils. The mass transfer standard foil sets are available from Thermo Fisher Scientific, and should be used as part of a QA Program for performing a QC check on the mass measurements. This mass foil calibration procedure can be used for QC checks, auditing, and calibration.

The Mass Calibration submenu is used to view and set the mass calibration point. The mass calibration screen is visible only when the instrument is in service mode. For more information on the service mode, see “[Service Mode](#)” earlier in the chapter.

**Note** This adjustment should only be performed by an instrument service technician. ▲

- In the Main Menu, choose Service > **Mass Calibration**>**Mass Coefficient**.

```
MASS CALIBRATION:
THERMAL COEFFICIENT
VACUUM COEFFICIENT
BARO COEFFICIENT
>MASS COEFFICIENT
ALPHA EFF COEFFICIENT

RANGE  AVG  DIAGS  ALARM
```

It is recommended to perform an annual mass calibration on the Model 5014*i* Beta Monitor.

- The foil sets must be kept in a clean container. **Do not** touch the foil window with your fingers.
- The foils must **not** be wiped, otherwise a loss or gain of mass can occur thereby biasing the mass calibration.
- Foils sets can be returned to Thermo Fisher Scientific for recalibration as necessary.
- Separate foil sets are recommended for periodic QC checks, auditing, and calibration.
- Should the user suspect the foil window(s) has been damaged, scratched, or coated, these foil sets should be returned to Thermo Fisher Scientific for re-calibration.

The null foil has the same approximate mass as a clean filter spot and the span foil is a calibrated mass increase above the null foil. Therefore, the foils come in a set and must not be mixed with other sets since a bias in mass calibration will occur.

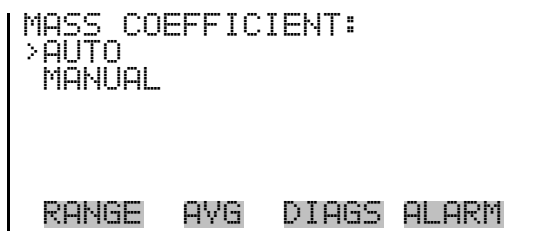
Since the beta attenuation method is linear with mass increase, the Model 5014*i* need not be calibrated in the exact range of beta attenuation per filter spot. What is important, is calibrating the corresponding beta count reduction with an increase of calibrated mass.



**Note** To achieve the most accurate mass calibration, the flow temperature should be as stable as possible and therefore the instrument should have the heating system turned off, and the instrument should be allowed to equilibrate to shelter or ambient temperature. If the Model 5014*i* Beta is mounted within an ambient shelter, then the most stable time of day to perform a mass calibration would be either early morning or late afternoon. ▲


**Mass Coefficient** The preferred method of mass coefficient calibration is the Auto Mode.

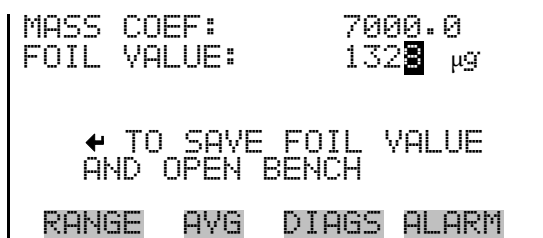
- In the Main Menu, choose Service > Mass Calibration > **Mass Coefficient**.




**Auto Mass Coefficient** The Auto Mass Coefficient screen allows the user to conduct a mass calibration of the measurement head and will walk you through the process.

Use the following procedure to conduct a mass calibration:

1. In the Main Menu, choose Service > Mass Calibration > Mass > **Auto**.
2. Enter the SPAN foil value (e.g., 1,328 µg) using the keypad and press  to save the foil value and to open the bench. The beta attenuation chamber should now open.





3. Cut/break the filter tape and remove from the bench. Then insert the Foil Holder from the calibration kit and press  while maintaining a slight sideward pressure on the filter holder.

```
MASS COEF:      7000.0
FOIL VALUE:    1328 µg

REMOVE TAPE, INSERT FOIL
HOLDER, ← TO CLOSE BENCH

RANGE  AVG  DIAGS  ALARM
```

4. Insert the Null/Zero foil with the label side up and press  to proceed with the foil calibration, or press  to stop the foil.

```
MASS COEF:      7000.0
FOIL VALUE:    1328 µg

INSERT NULL FOIL
← TO START ZERO CAL

RANGE  AVG  DIAGS  ALARM
```

```
MASS COEF:      7000.0
FOIL VALUE:    1328 µg
Beta Avg      12016 1/sec

PLEASE WAIT    265 sec



RANGE  AVG  DIAGS  ALARM
```

The auto zero procedure of mass will begin and last approximately 270 seconds. When the zero is complete, the beta attenuation measurement will remain closed and an average Beta count rate is displayed.

```
MASS COEF:      7000.0
FOIL VALUE:    1328 µg
Beta Avg      12022 1/sec

REMOVE NULL FOIL
← TO CONTINUE

RANGE  AVG  DIAGS  ALARM
```

5. Remove the zero/null foil and insert with the Span foil (e.g., 1328 ug) and press  to begin the span calibration, or press  to stop the foil.

```

MASS COEF:      7000.0
FOIL VALUE:    1328 µg
Beta Avg       12022 1/sec

  INSERT SPAN FOIL
  ← TO START MASS CAL

RANGE  AVG  DIAGS  ALARM
  
```

```

MASS COEF:      7000.0
FOIL VALUE:    1328 µg
Beta Avg       9884 1/sec

      PLEASE WAIT      245 sec

RANGE  AVG  DIAGS  ALARM
  
```

The span foil calibration procedure is now active and after another 270 seconds the calibration procedure should end, whereby a new Mass Coef value is shown and the percent difference is shown from the last foil calibration to the current calibration. This percent difference can also be used to directly audit the mass coefficient value since a percent difference in a mass coefficient is the same percent mass difference overall.

```

MASS COEF:      6878.7
FOIL VALUE:    1328 µg
Beta Avg       9911 1/SEC
difference      -1.7 %
  REMOVE SPAN FOIL
  ← TO CONTINUE

RANGE  AVG  DIAGS  ALARM
  
```

- After the span calibration, the screen will ask you to press  to accept the new calibration. Otherwise press  to keep the old Mass Coef value. Remove the span foil and press . The bench will now open. Remove the filter holder, replace the filter tape and press  to confirm the calibration routine has now been completed.

```

MASS COEF:      6878.7
FOIL VALUE:    1328 µg
Beta Avg       9911 1/sec
difference      -1.7 %
  REMOVE, HOLDE, INSERT
  TAPE, ← TO CLOSE BENCH

RANGE  AVG  DIAGS  ALARM
  
```

```
MASS COEF:      6878.7
FOIL VALUE:    1328 µg
Beta Avg      9911 1/sec
difference     -1.7 %
  ← TO ACCEPT NEW VALUES
  ← TO DECLINE

RANGE  AVG  DIAGS  ALARM
```

## Detector Calibration

The Detector Calibration submenu is used to view and set the detector calibration. The detector calibration screen is visible only when the instrument is in service mode. For more information on the service mode, see “[Service Mode](#)” earlier in the chapter.

**Note** This adjustment should only be performed by an instrument service technician. ▲

- In the Main Menu, choose Service > **Detector Calibration**.

```
DETECTOR CALIBRATION:
>AUTO
  MANUAL

RANGE  AVG  DIAGS  ALARM
```

## Auto Detector Calibration

The Auto Detector Calibration screen allows the user to optimize the detector performance. This should be done at least once per year and as often as once per quarter.

- In the Main Menu, choose Service > Detector Calibration > **Auto**.

```
DETECTOR AUTO CAL:
HIGH VOLT:    1500 V
BETA CNT :    14649 1/sec

PRESS ← TO START AUTO CAL

RANGE  AVG  DIAGS  ALARM
```

This procedure will take approximately 30 minutes until completed. Thereafter, a high voltage (HV), beta reference threshold and alpha threshold will be assigned a new value.

## Chapter 5

# Preventive Maintenance

This chapter describes the periodic maintenance procedures that should be performed on the instrument to ensure proper operation. Since usage and environmental conditions vary greatly, you should inspect the components frequently until an appropriate maintenance schedule is determined.

This chapter includes the following preventive maintenance information:

- “Safety Precautions” on page 5-1
- “Replacement Parts” on page 5-2
- “Cleaning the Outside Case” on page 5-2
- “Cleaning the Inlets” on page 5-2
- “Fan Filter Inspection and Cleaning” on page 5-5
- “Pump Rebuilding” on page 5-6
- “Leak Test” on page 5-6
- “Filter Tape Replacement” on page 5-7
- “Greasing the Cam” on page 5-8

### Safety Precautions

Read the safety precautions before beginning any procedures in this chapter.



**WARNING** If the equipment is operated in a manner not specified by the manufacturer, the protection provided by the equipment may be impaired. ▲



**Equipment Damage** Some internal components can be damaged by small amounts of static electricity. A properly grounded antistatic wrist strap must be worn while handling any internal component. For more information about appropriate safety precautions, see the “[Servicing](#)” chapter. ▲

## Replacement Parts

See the “[Servicing](#)” chapter for a list of replacement parts and the associated replacement procedures.



**WARNING** If the equipment is operated in a manner not specified by the manufacturer, the protection provided by the equipment may be impaired. ▲

## Cleaning the Outside Case

Clean the outside case using a damp cloth being careful not to damage the labels on the case.



**Equipment Damage** Do not use solvents or other cleaning products to clean the outside case. ▲

## Cleaning the Inlets

The inlet assemblies can include a TSP inlet, a U.S. EPA compatible PM<sub>10</sub> inlet, or a Digital PM<sub>10</sub> or PM<sub>2.5</sub> inlet. Cleaning schedules and routine maintenance of assembly components should be in accordance with a good quality assurance plan.

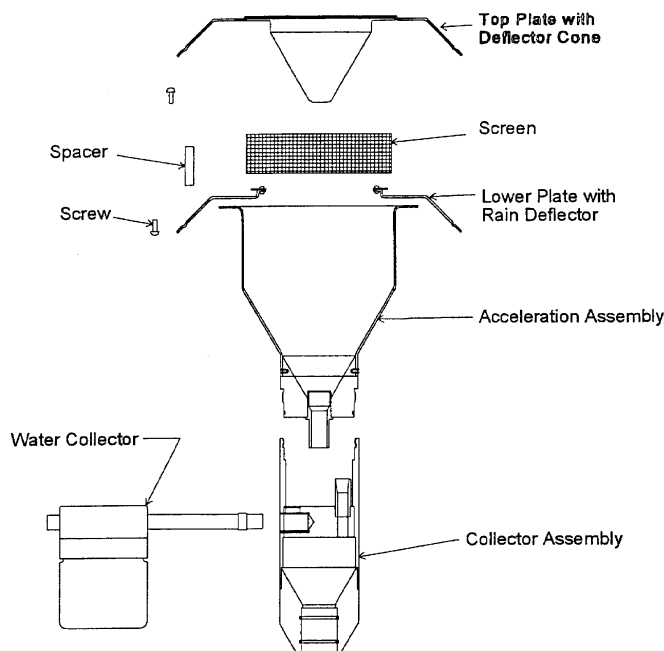
In general, it is recommended that the inlet assemblies be cleaned on a quarterly interval with mild soap solution, a thorough rinsing, and dried with a lint free cloth. If any impaction surfaces require impactor grease, it should be applied prior to reassembly. Furthermore, a general inspection, and replacement as necessary, of o-rings should be done.



**Equipment Damage** Some internal components can be damaged by small amounts of static electricity. A properly grounded antistatic wrist strap must be worn while handling any internal component. For more information about appropriate safety precautions, see the “[Servicing](#)” chapter. ▲

## U.S. EPA PM<sub>10</sub> Inlet

The water collector bottle located on the PM<sub>10</sub> inlet should be inspected at least every five sampling days ([Figure 5–1](#)). Remove any accumulated water, clean the interior of the bottle, inspect the seals, and replace the bottle in the holder.



**Figure 5–1.** U.S. EPA PM<sub>10</sub> Inlet

Once a month the sampler inlet should be dismantled and cleaned. Mark each assembly point of the sampler inlet with a pen or pencil to provide reference marks during reassembly.

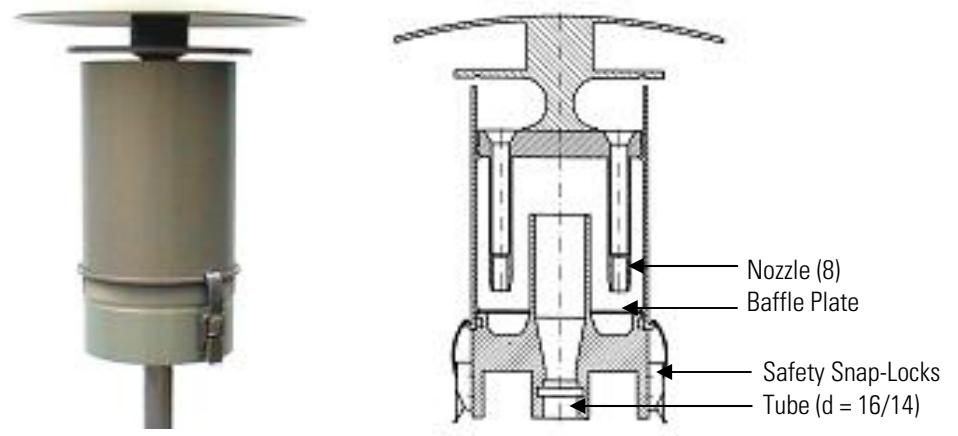
Disassemble the sample inlet unit according to [Figure 5–1](#). If the assembly screws are frozen, apply penetrating oil or commercial lubricant to make removal easier. Clean all interior surfaces and the bug screen with a general purpose cleaner or compressed air, paying particular attention to small openings and cracks. Cotton swabs and/or a small brush are helpful. Completely dry all components.

Also monthly, check the O-rings for distortion, cracks, fraying, or other problems and replace as necessary. Apply small amounts of grease to the rings before assembling the unit.

Reassemble the unit in accordance with the previously scribed match marks. Particular care should be taken to ensure that all O-rings seals are properly seated and that all screws are uniformly tightened.

## European PM<sub>10</sub>/PM<sub>2.5</sub> Inlet

The same schedule should be used for the European PM<sub>10</sub> Inlet (e.g. Leckel), at approximately a 1-2 month interval. The components of the inlet should be inspected and cleaned as necessary. [Figure 5–2](#) provided below provides an image and design drawing of the inlet, with references to parts.



**Figure 5–2.** European PM<sub>10</sub> Inlet

PM<sub>10</sub> size selective inlet (1 m<sup>3</sup>/h) for 5014*i* Beta:

- Same construction as the EN reference inlet, but with 1 m<sup>3</sup>/h
- With special surface protection using an aluminium EMATAL surface
- With special water separator and easy exchangeable impactor baffle plate
- Standard tube connection: d = 16 mm for connecting a continuous monitor
- Easy converting to PM<sub>2.5</sub> using the PM<sub>2.5</sub> nozzle plate (8 nozzles)
- Easy converting to PM<sub>1</sub> using the PM<sub>1</sub> nozzle plate (8 nozzles)

## **Cyclone Maintenance**

If a Sharp-Cut Cyclone (SCC) or a BGI Very Sharp-Cut Cyclone is being used for PM<sub>2.5</sub> sampling ([Figure 5–3](#)), once every 2-3 weeks the dust pot should be unscrewed, emptied, and cleaned with a lint-free cloth. Once every three months, the entire SCC assembly should be inspected and cleaned, O-rings checked for distortion, cracks, fraying, or other problems. Replace O-rings as necessary.





**Figure 5–3.** PM<sub>2.5</sub> Sharp-Cut-Cyclone

## Heater and Sample Tube

On at least an annual basis (more frequently in heavily polluted environments) the sample tube that attaches to the inlet and to the Model 5014*i* Beta should be removed and cleaned. The use of a bottle brush and string will allow you to remove any deposits within the sample tube. This same procedure also applies to the heater tube.

## Weather Proofing

The “[Installation](#)” chapter covers detailed installation instructions. After proper installation, it is recommended to check the weather-proof installation at all interfaces exposed to ambient conditions. Ensure that the condition of the roof flange and silicone caulking will prevent any precipitation from entering the shelter and possibly damaging the instrument’s electronics.

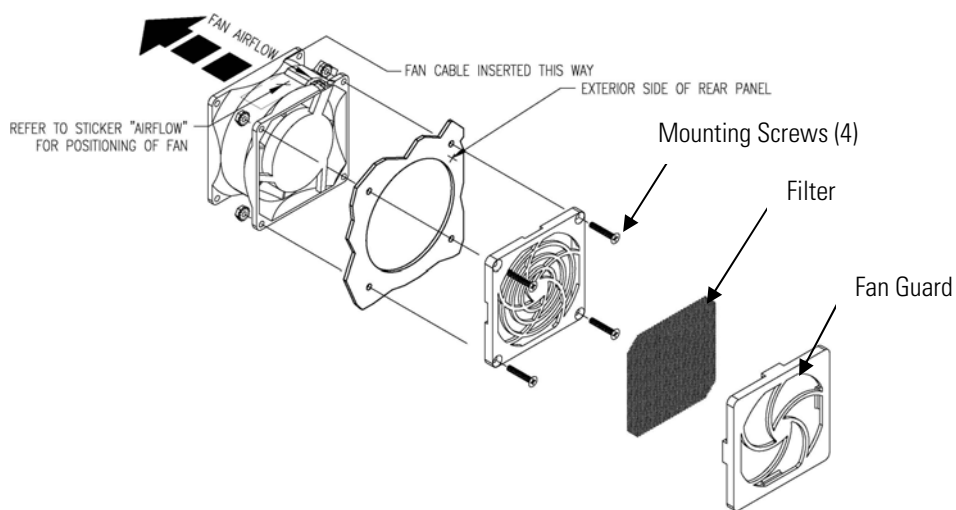
## Fan Filter Inspection and Cleaning

Use the following procedure to inspect and clean the fan filter ([Figure 5–4](#)).

1. Remove the fan guard from the fan and remove the filter.
2. Flush the filter with warm water and let dry (a clean, oil-free purge will help the drying process) or blow the filter clean with compressed air.
3. Re-install the filter and fan guard.



**Equipment Damage** Some internal components can be damaged by small amounts of static electricity. A properly grounded antistatic wrist strap must be worn while handling any internal component. For more information about appropriate safety precautions, see the “[Servicing](#)” chapter. ▲



**Figure 5–4.** Inspecting and Cleaning the Fan

## Pump Rebuilding

Rebuild the sample pump once every 12–18 months, or as necessary depending on the environment it is used in. The pump repair kit contains instructions for rebuilding the pump. See the “[Servicing](#)” chapter for a list of replacement parts. Perform the “[Leak Test](#)” procedure that follows.

## Leak Test

This leak test procedure uses a volumetric flow meter and a custom leak check adapter. Use the following procedure to verify no leaks.

1. Place a reference volumetric flow meter (e.g., BGI Delta Cal) onto the inlet adapter and calibrate the 5014*i* so that the reference flow meter and the 5014*i* monitor read the same flow rate.
2. Install the custom leak check adapter onto the inlet adapter and then place the reference flow meter onto the leak check adapter.



3. Record the reference volumetric flow meter reading and the instant flow reading. If the difference between both readings is less than 0.42 L/min ( $\pm 2.5\%$ ), the leak check passes.

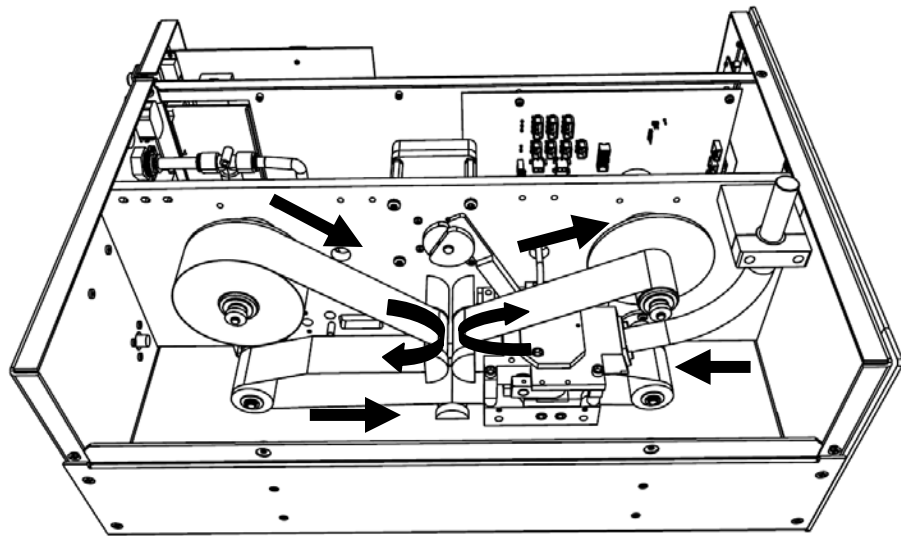
## Filter Tape Replacement



Use the following procedure to replace the filter tape in case of breaks or if the tape runs out.

**Equipment Damage** Some internal components can be damaged by small amounts of static electricity. A properly grounded antistatic wrist strap must be worn while handling any internal component. For more information about appropriate safety precautions, see the “[Servicing](#)” chapter. ▲

1. Remove left side cover.
2. From the main menu choose Instrument Controls > Filter Tape Control > Manual > **Bench(s)**. Press .
3. Loosen both reel nuts on tape spindler. Remove used filter tape and empty tape spool from tape spindles.
4. Insert new filter tape on left tape spindle and tighten reel nut.
5. Insert new blank pick up spool on right tape spindle.
6. Route tape according to [Figure 5-5](#).
7. Attach end of tape to blank tape spool on right tape spindle with 2-inch of tape.
8. Turn blank tape spool until there is two complete wrappings of tape.
9. Tighten right reel nut. From Filter Tape Control > Manual > choose **Tape** and press  to MOVE tape.
10. From the main menu choose Alarms > **Instrument Alarms** to verify that there are no filter tape alarms.
11. Replace left side cover.



**Figure 5-5.** Replacing the Filter Tape

## **Greasing the Cam**

Use the following procedure to grease the cam.

Equipment Required:

Dow Corning Molykote G-N

1. Apply metal assembly paste around the parameter of the cam.

# Chapter 6

## Troubleshooting

This instrument has been designed to achieve a high level of reliability. In the event of problems or failure, the troubleshooting guidelines, board-level connection diagrams, connector pin descriptions, and testing procedures presented in this chapter should be helpful in isolating and identifying problems.

The Technical Support Department at Thermo Fisher Scientific can also be consulted in the event of problems. See “[Service Locations](#)” on page 6-22 for contact information. In any correspondence with the factory, please note both the serial number and program number of the instrument.

This chapter provides the following troubleshooting and service support information:

- “[Safety Precautions](#)” on page 6-1
- “[Troubleshooting Guides](#)” on page 6-1
- “[Board-Level Connection Diagrams](#)” on page 6-6
- “[Connector Pin Descriptions](#)” on page 6-8
- “[Service Locations](#)” on page 6-22

### Safety Precautions

Read the safety precautions in the Preface and “[Servicing](#)” chapter before performing any actions listed in this chapter.

### Troubleshooting Guides

The troubleshooting guides presented in this chapter are designed to help isolate and identify instrument problems.

[Table 6–1](#) provides general troubleshooting information and indicates the checks that you should perform if you experience an instrument problem.

[Table 6–2](#) lists all the alarm messages you may see on the graphics display and provides recommendations about how to resolve the alarm condition.

**Table 6–1.** Troubleshooting - General Guide

<b>Malfunction</b>	<b>Possible Cause</b>	<b>Action</b>
No power	Main fuses are blown or missing	Check voltages from power supply.
	Digital electronics defective	Check that all boards and connectors are seated properly. Replace with spare boards to isolate the problem.
No automatic filter change	Reel nuts not tight	Tighten reel nuts.
	No more filter tape	Replace with new filter tape.
	Filter not properly adhered or broken	Adhere filter tape to take-up reel and wind over itself once.
	Filter tape transport drive motor defective	Replace motor.
Pressure sensor(s) board do not hold calibration	Optical tape counter defective	Replace optical tape transport sensor.
	Valves closed	Verify $\Delta P$ valves on rear panel are in the closed position.
Highly variable concentration	Loose plumbing	Verify all plumbing connections.
	Pressure board defective	Replace pressure printed circuit board.
Instrument does not calibrate properly	Recorder noise	Replace or repair recorder and/or leads.
	Sample concentration varying	Run Model 5014 <i>i</i> on a zero filter – if quiet, there is no malfunction.
	Foreign material in optical bench	Clean optical bench.
	Digital electronics defective	Replace board with a spare board.
Display is off	System leak	Find and repair leak.
	Pressure or temperature out of calibration	Re-calibrate pressure or temperature.
	Digital electronics defective	Replace one board at a time with a spare board to isolate the defective board.
	Flow	Verify $\Delta P$ valves on rear panel are in the closed position. Re-calibrate.
Display is off	Wrong contrast setting	Adjust contrast setting.

<b>Malfunction</b>	<b>Possible Cause</b>	<b>Action</b>
	LCD cable loose	Check connection and cable integrity.
	LCD defective	Replace display.
The change of parameters is not possible	Keyboard not enabled	Enable keyboard through menu.
No mass value	ADC defect	Change the main circuit board.
	Mains are broken	Check and repair.
	No high voltage value	Check HV.
	Detector defect	Change detector.
No automatic filter change	Mechanical defect	Check filter transport motor and mechanics. Make sure tape is adhered to take-up reel and intact.
	If pump is not running	Check pump power supply and wires.
	If the filter change parameter reaches the FC-value for the second time, then, the monitor stops	Adjust filter change parameters.
LCD out of function or dark	Wrong contrast	Adjust contrast.
	LCD defect	Change LCD.
	Connection cables from the main board are broken	Replace display ribbon cable.
Air flow rate disturbance or air flow is too low	Air flow parameters wrong	Check air flow rate parameters.
	No connection with plug (25) "pump"	Put in the plug (pump regulation input).
	Pump do not work properly	Clean inside parts of pump change.
	Very high pollution or blocking in the air passage	Clean air passage.
	Check $\Delta P$ calibration valve are in closed position	Close valves.

**Table 6–2.** Troubleshooting - Alarm Messages

<b>Alarm Message</b>	<b>Possible Cause</b>	<b>Action</b>
Instrument Alarms – Filter Tape Counter	Loose reel nuts	Tighten reel nuts.
	Broken tape	Replace tape.
	Loose photo interrupt cable	Verify connections.
Instrument Alarms – Filter Tape Change	Loose reel nuts	Tighten reel nuts.
	Broken tape	Replace tape.
	Tape motor nut turning	Verify connection to measurement interface board. Replace tape motor.
Instrument Alarms – Bench	Cam working not functioning	Verify connector to measurement interface board. Replace motor.
	Motor turning, cam not	Verify setscrews on cam coupling.
Instrument Alarms – Motherboard Status	Internal cables not connected properly	Check that all internal cables are connected properly. Re-cycle AC power to instrument. If still alarming, change board.
Instrument Alarms – Interface Status	Board defective	Replace board.
Instrument Alarms – I/O Exp Status		
Detector Alarms – Alpha	Detector	Re-calibrate detector.
	Settings	Verify alarm settings are between 0 minimum and 100 maximum.
Detector Alarms – Beta	Disconnected cable	Verify cable connections.
	Defective detector	Replace detector-Beta counts trending towards zero.
	Settings	Verify alarm settings are between 5000 minimum and 20000 maximum.
RH/Temperature Alarms – Ambient RH	Disconnect cable (external) on rear panel	Verify cable connection.
	Disconnect cable (internal)	Verify cable connection.
RH/Temperature Alarms – Sample RH	Disconnected heater	Verify cable connection.



<b>Alarm Message</b>	<b>Possible Cause</b>	<b>Action</b>
RH/Temperature Alarms – Ambient Temp	Disconnect cable (external) on rear panel	Verify cable connection.
	Disconnect cable (internal)	Verify cable connection.
RH/Temperature Alarms – Flow Temp	Disconnected cable	Verify connection to measurement interface board.
	Sensor defective	Replace sensor.
RH/Temperature Alarms – Board Temp	Disconnected cable	Verify connection to measurement interface board.
	Sensor defective	Replace sensor.
Pressure/Vacuum Alarms – Barometer Pressure	Disconnected cable	Verify cable connections. Replace board.
Pressure/Vacuum Alarms – Vacuum	Disconnected plumbing	Verify plumbing connections.
	Disconnected cable	Verify cable connection.
	Sensor defective	Replace pressure board.
Pressure/Vacuum Alarms – Flow	Disconnected plumbing	Verify plumbing connections
	Disconnected cable	Verify cable connection.
	Sensor defective	Replace pressure board.
	$\Delta P$ valve open	Verify valve is in close position.
Flow Alarms – Flow	Low flow	Check that pump is connected. Verify that both $\Delta P$ valves are in the closed position.
	No flow	Verify proportional valve plumbing. Verify connection to measurement interface board.
Conc Alarms – PM	Conc negative	Check heater and Beta counts.
	Conc alarm setting	Verify conc alarm settings.

## Board-Level Connection Diagrams

Figure 6–1 and Figure 6–2 are board-level connection diagrams for the common electronics and measurement system. These illustrations can be used along with the connector pin descriptions in Table 6–3 through Table 6–7 to troubleshoot board-level faults.

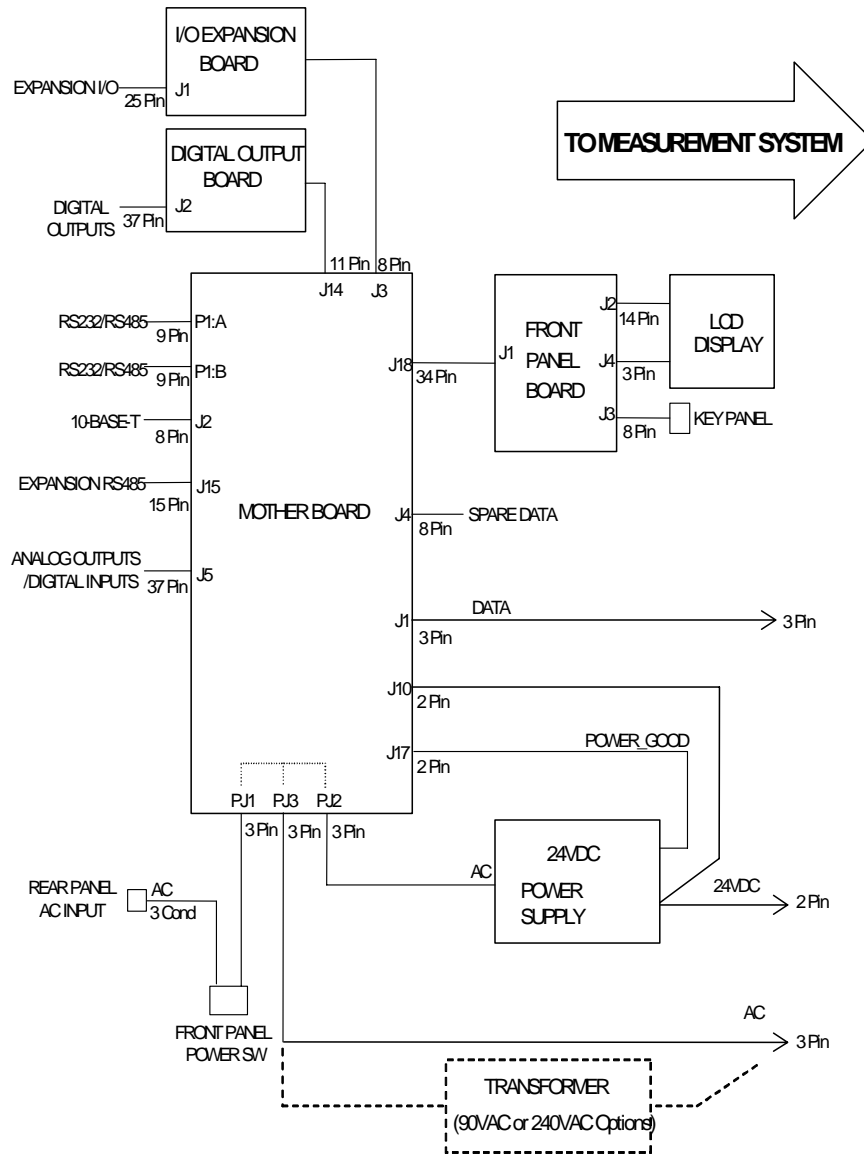


Figure 6–1. Board-Level Connection Diagram - Common Electronics

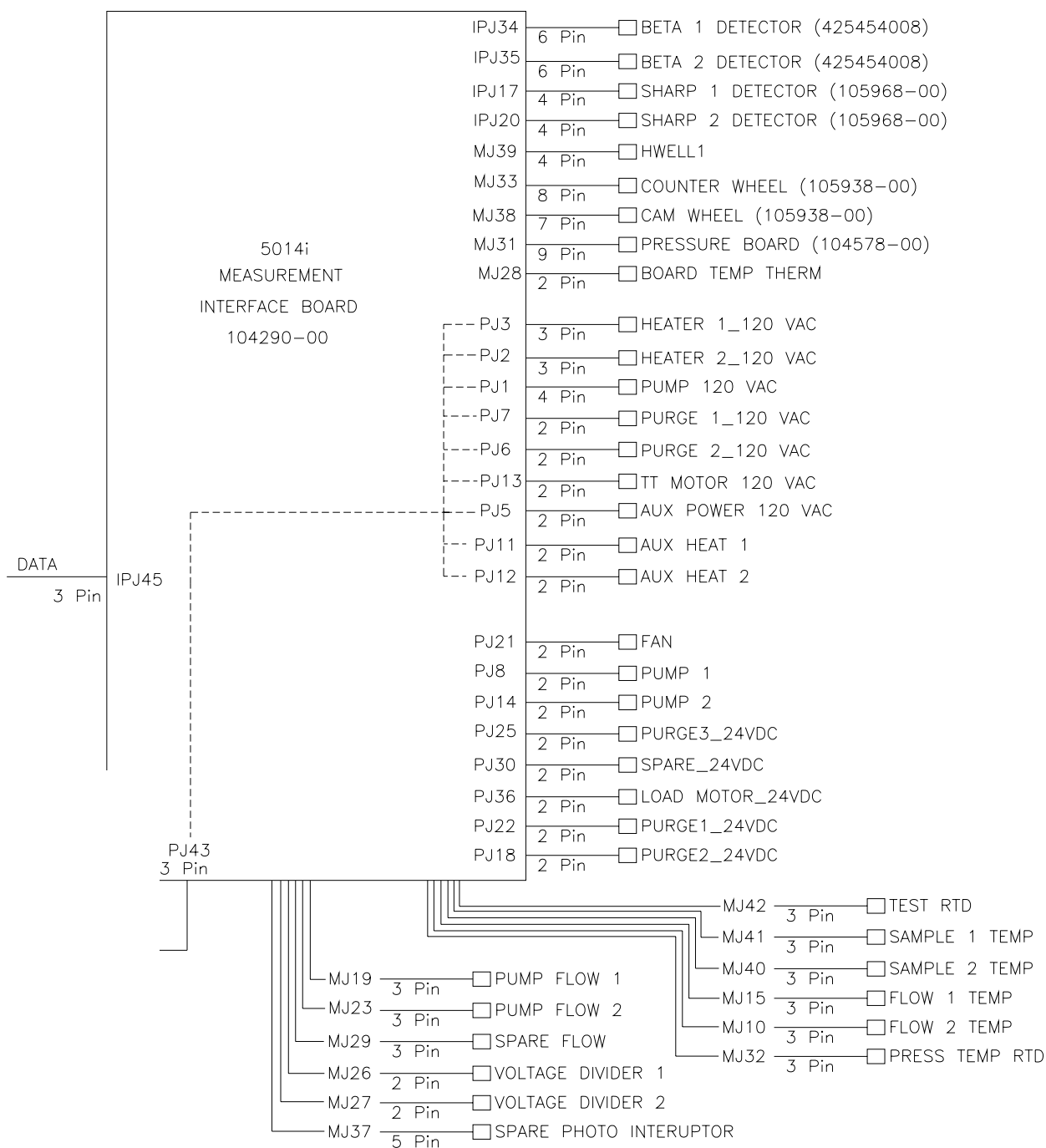


Figure 6-2. Board-Level Connection Diagram - Measurement System

## Connector Pin Descriptions

The connector pin descriptions in Table 6–3 through Table 6–7 can be used along with the board-level connection diagrams to troubleshoot board-level faults.

“Motherboard Connector Pin Descriptions” on page 6-8

“Measurement Interface Board Connector Pin Descriptions” on page 6-13

“Front Panel Board Connector Pin Diagram” on page 6-17

“I/O Expansion Board (Optional) Connector Pin Descriptions” on page 6-19

“Digital Output Board Connector Pin Descriptions” on page 6-20

**Table 6–3.** Motherboard Connector Pin Descriptions

Connector Label	Reference Designator	Pin	Signal Description
INTF DATA	J1	1	Ground
		2	+RS485 to Interface Board
		3	-RS485 to Interface Board
10-BASE-T	J2	1	Ethernet Output (+)
		2	Ethernet Output (-)
		3	Ethernet Input (+)
		4	NC
		5	NC
		6	Ethernet Input (-)
		7	NC
		8	NC
EXPANSION BD	J3	1	+5V
		2	+24V
		3	+24V
		4	Ground
		5	Ground
		6	Ground
		7	+RS485 to Expansion Board
		8	-RS485 to Expansion Board
INTERFACE 24V	J4	1	+24V
		2	Ground

<b>Connector Label</b>	<b>Reference Designator</b>	<b>Pin</b>	<b>Signal Description</b>
I/O	J5	1	Power Fail Relay N.C. Contact
		2	Digital Ground
		3	TTL Input 1
		4	TTL Input 2
		5	Digital Ground
		6	TTL Input 5
		7	TTL Input 7
		8	TTL Input 8
		9	TTL Input 10
		10	Ground
		11	TTL Input 13
		12	TTL Input 15
		13	Digital Ground
		14	Analog Voltage 1
		15	Analog Voltage 3
		16	Analog Ground
		17	Analog Voltage 5
		18	Analog Ground
		19	Analog Ground
		20	Power Fail Relay COM
		21	Power Fail Relay N.O. Contact
		22	Digital Ground
		23	TTL Input 3
		24	TTL Input 4
		25	TTL Input 6
		26	Digital Ground
		27	TTL Input 9
		28	TTL Input 11
		29	TTL Input 12
		30	TTL Input 14
		31	TTL Input 16
		32	Digital Ground
		33	Analog Voltage 2
		34	Analog Voltage 4

## Troubleshooting

### Connector Pin Descriptions

Connector Label	Reference Designator	Pin	Signal Description
		35	Analog Ground
		36	Analog Voltage 6
		37	Analog Ground
VOLTAGE TEST	J6	1	+5V
		2	+3.3V
			+15V
			-15V
SER EN	J7	1	Serial Enable Jumper
		2	+3.3V
24V IN	J10	1	+24V
		2	Ground
RESET PROC	J12	1	Reset-Proc
		2	Ground
DIGITAL I/O	J14	1	+5V
		2	+24V
		3	+24V
		4	Ground
		5	Ground
		6	Ground
		7	SPI Reset
		8	SPI Input
		9	SPI Output
		10	SPI Board Select
		11	SPI Clock
EXT. RS485	J15	1	-RS485 to Rear Panel
		2	-RS485 to Rear Panel
		3	+5V
		4	+5V
		5	+5V
		6	Ground
		7	Ground
		8	Ground
		9	NC
		10	NC

Connector Label	Reference Designator	Pin	Signal Description
		11	+24
		12	+24
		13	+24
		14	+24
		15	+24
24 MONITOR	J17	1	24V Power Monitor
		2	Ground
FRONT PANEL BD	J18	1	Ground
		2	Ground
		3	LCLK – LCD Signal
		4	Ground
		5	Ground
		6	LLP – LCD Signal
		7	LFLM – LCD Signal
		8	LD4 – LCD Signal
		9	LD0 – LCD Signal
		10	LD5 – LCD Signal
		11	LD1 – LCD Signal
		12	LD6 – LCD Signal
		13	LD2 – LCD Signal
		14	LD7 – LCD Signal
		15	LD3 – LCD Signal
		16	LCD Bias Voltage
		17	+5V
		18	Ground
		19	Ground
		20	LCD_ONOFF – LCD Signal
		21	Keypad Row 2 Input
		22	Keypad Row 1 Input
		23	Keypad Row 4 Input
		24	Keypad Row 3 Input
		25	Keypad Col 2 Select
		26	Keypad Col 1 Select

## Troubleshooting

### Connector Pin Descriptions

Connector Label	Reference Designator	Pin	Signal Description
		27	Keypad Col 4 Select
		28	Keypad Col 3 Select
		29	Ground
		30	Ground
		31	Ground
		32	Ground
		33	+24V
		34	+24V
RS232/RS485:A	P1:A	1	NC
		2	Serial Port 1 RX (-RS485 IN)
		3	Serial Port 1 TX (-RS485 OUT)
		4	NC
		5	Ground
		6	NC
		7	Serial Port 1 RTS (+RS485 OUT)
		8	Serial Port 1 CTS (+RS485 IN)
		9	NC
RS232/RS485:B	P1:B	1	NC
		2	Serial Port 2 RX (-RS485 IN)
		3	Serial Port 2 TX (-RS485 OUT)
		4	NC
		5	Ground
		6	NC
		7	Serial Port 2 RTS (+RS485 OUT)
		8	Serial Port 2 CTS (+RS485 IN)
		9	NC
AC IN	PJ1	1	AC-HOT
		2	AC-NEUT
		3	AC-Ground
AC 24VPWR	PJ2	1	AC-HOT
		2	AC-NEUT
		3	AC-Ground
AC INTF BD	PJ3	1	AC-HOT
		2	AC-NEUT



Connector Label	Reference Designator	Pin	Signal Description
		3	AC-Ground

**Table 6–4.** Measurement Interface Board Connector Pin Descriptions

Connector Label	Reference Designator	Pin	Signal Description
PUMP	J1	1	AC+
		2	Pump_AC-
		3	AC-Ground
		4	NC
HEATER 2	J2	1	AC+
		2	Heater2_AC-
		3	AC-Ground
HEATER 1	J3	1	AC+
		2	Heater1_AC-
		3	AC-Ground
WDT DISABLE	J4	1	Input
		2	Ground
AUX PWR 120V	J5	1	AC+
		2	AC-
PURGE 2	J6	1	AC+
		2	Purge2_AC-
PURGE 1	J7	1	AC+
		2	Purge1_AC-
PUMP 1	J8	1	+24V
		2	Pump1_On/Off
JTAG INTF	J9	1	TD0
		2	NC
		3	TD1
		4	NC
		5	TMS
		6	NC
		7	TCK
		8	NC

## Troubleshooting

### Connector Pin Descriptions

Connector Label	Reference Designator	Pin	Signal Description
		9	Ground
		10	NC
		11	NC
		12	NC
		13	NC
		14	NC
FLOW TEMP 2	J10	1	Flow2A_RTD
		2	Flow2B_RTD
		3	Ground
AUX HT 1	J11	1	AC+
		2	AuxHT_1_AC-
AUX HT 2	J12	1	AC+
		2	AuxHT_2_AC-
TT MOTOR	J13	1	AC+
		2	TT Motor_AC-
PUMP 2	J14	1	+24V
		2	Pump2_On/Off
FLOW TEMP 1	J15	1	Flow1A_RTD
		2	Flow1B_RTD
		3	Ground
SHARP 1	J17	1	+24V
		2	+RS485
		3	-RS485
		4	Ground
PURGE 2 DC	J18	1	+24V
		2	Purge2_DC
PUMP FLOW 1	J19	1	+24V
		2	Aout_Pump1_Flow
		3	Ground
SHARP 2	J20	1	+24V
		2	+RS485
		3	-RS485
		4	Ground
FAN	J21	1	+24V

Connector Label	Reference Designator	Pin	Signal Description
		2	Fan_Power
PURGE 1 DC	J22	1	+24V
		2	Purge1_DC
PUMP FLOW 2	J23	1	+24V
		2	Aout_Pump2_Flow
		3	Ground
PURGE 3 DC	J25	1	+24V
		2	Spare1_Sol
VD1	J26	1	AIN_VD-1
		2	Ground
VD2	J27	1	AIN_VD-2
		2	Ground
BOARD TEMP	J28	1	Board_Therm
		2	Ground
SPARE FLOW	J29	1	+24V
		2	Aout_Spare_Flow
		3	Ground
PURGE 4 DC	J30	1	+24V
		2	Spare2_Sol
PRESS BD	J31	1	-15V
		2	AIN_30PSIA
		3	AIN_FLOW_1
		4	AIN_VAC_2
		5	AIN_FLOW_2
		6	AIN_VAC_1
		7	+5V
		8	+15V
		9	Ground
PRESS TEMP	J32	1	Press_RTD
		2	Press_RTD
		3	Ground
CNTR WHEEL	J33	1	+5V
		2	Ground
		3	Ground

## Troubleshooting

### Connector Pin Descriptions

Connector Label	Reference Designator	Pin	Signal Description
		4	Ground
		5	VOA3
		6	+5V
		7	NC
		8	NC
BETA 1	J34	1	Ground
		2	+RS485
		3	-RS485
		4	Ground
		5	+5V
		6	Ground
BETA 2	J35	1	Ground
		2	+RS485
		3	-RS485
		4	Ground
		5	+5V
		6	Ground
LOAD MOTOR	J36	1	+24V
		2	Load_Motor_On
SP PHOTO	J37	1	+5V
		2	Ground
		3	Ground
		4	+5V
		5	VO_SP
CAM WHEEL	J38	1	+5V
		2	Ground
		3	Ground
		4	NC
		5	Dig_Slit
		6	+5V
		7	NC
HWELL 1	J39	1	AIN_RTDP
		2	+5V
		3	AIN_RHP_Hum

Connector Label	Reference Designator	Pin	Signal Description
		4	Ground
SAMPLE 2 TEMP	J40	1	Sample2A_RTD
		2	Sample2B_RTD
		3	Ground
SAMPLE 1 TEMP	J41	1	Sample1A_RTD
		2	Sample1B_RTD
		3	Ground
TEST RTD	J42	1	SpareA_RTD
		2	SpareB_RTD
		3	Ground
AC IN	J43	1	AC+
		2	AC-
		3	AC-Ground
24V IN	J44	1	+24V
		2	Ground
DATA	J45	1	Ground
		2	+RS485
		3	-RS485

**Table 6–5.** Front Panel Board Connector Pin Diagram

Connector Label	Reference Designator	Pin	Signal Description
MOTHERBOARD	J1	1	Ground
		2	Ground
		3	LCLK – LCD Signal
		4	Ground
		5	Ground
		6	LLP – LCD Signal
		7	LFLM – LCD Signal
		8	LD4 – LCD Signal
		9	LD0 – LCD Signal
		10	LD5 – LCD Signal
		11	LD1 – LCD Signal

## Troubleshooting

### Connector Pin Descriptions

Connector Label	Reference Designator	Pin	Signal Description
		12	LD6 – LCD Signal
		13	LD2 – LCD Signal
		14	LD7 – LCD Signal
		15	LD3 – LCD Signal
		16	LCD Bias Voltage
		17	+5V
		18	Ground
		19	Ground
		20	LCD_ONOFF – LCD Signal
		21	Keypad Row 2 Input
		22	Keypad Row 1 Input
		23	Keypad Row 4 Input
		24	Keypad Row 3 Input
		25	Keypad Col 2 Select
		26	Keypad Col 1 Select
		27	Keypad Col 4 Select
		28	Keypad Col 3 Select
		29	Ground
		30	Ground
		31	Ground
		32	Ground
		33	+24V
		34	+24V
LCD DATA	J2	1	LD0_5V – LCD Signal
		2	LD1_5V – LCD Signal
		3	LD2_5V – LCD Signal
		4	LD3_5V – LCD Signal
		5	LCD_ONOFF_5V – LCD Signal
		6	LFLM_5V – LCD Signal
		7	NC
		8	LLP_5V – LCD Signal
		9	LCLK_5V – LCD Signal
		10	+5V
		11	Ground

Connector Label	Reference Designator	Pin	Signal Description
		12	-25V
		13	LCD Bias Voltage
		14	Ground
KEYBOARD	J3	1	Keypad Row 1 Input
		2	Keypad Row 2 Input
		3	Keypad Row 3 Input
		4	Keypad Row 4 Input
		5	Keypad Col 1 Select
		6	Keypad Col 2 Select
		7	Keypad Col 3 Select
		8	Keypad Col 4 Select
LCD BACKLIGHT	J4	1	+5V Supply
		2	NC
		3	Ground

**Table 6–6.** I/O Expansion Board (Optional) Connector Pin Descriptions

Connector Label	Reference Designator	Pin	Signal Description
EXPANSION I/O	J1	1	Analog Voltage Input 1
		2	Analog Voltage Input 2
		3	Analog Voltage Input 3
		4	Ground
		5	Analog Voltage Input 4
		6	Analog Voltage Input 5
		7	Analog Voltage Input 6
		8	Ground
		9	Analog Voltage Input 7
		10	Analog Voltage Input 8
		11	Ground
		12	NC
		13	Current Output Return
		14	Ground
		15	Current Output 1

## Troubleshooting

### Connector Pin Descriptions

Connector Label	Reference Designator	Pin	Signal Description
		16	Current Output Return
		17	Current Output 2
		18	Current Output Return
		19	Current Output 3
		20	Current Output Return
		21	Current Output 4
		22	Current Output Return
		23	Current Output 5
		24	Current Output Return
		25	Current Output 6
MOTHER BD	J2	1	+5V
		2	+24V
		3	+24V
		4	Ground
		5	Ground
		6	Ground
		7	+RS485 to Motherboard
		8	-RS485 to Motherboard

**Table 6–7.** Digital Output Board Connector Pin Descriptions

Connector Label	Reference Designator	Pin	Signal Description
MOTHER BD	J1	1	+5V
		2	+24V
		3	+24V
		4	Ground
		5	Ground
		6	Ground
		7	SPI Reset
		8	SPI Input
		9	SPI Output
		10	SPI Board Select
		11	SPI Clock



<b>Connector Label</b>	<b>Reference Designator</b>	<b>Pin</b>	<b>Signal Description</b>
DIGITAL OUTPUTS	J2	1	Relay 1 Contact a
		2	Relay 2 Contact a
		3	Relay 3 Contact a
		4	Relay 4 Contact a
		5	Relay 5 Contact a
		6	Relay 6 Contact a
		7	Relay 7 Contact a
		8	Relay 8 Contact a
		9	Relay 9 Contact a
		10	Relay 10 Contact a
		11	NC
		12	Solenoid Drive Output 1
		13	Solenoid Drive Output 2
		14	Solenoid Drive Output 3
		15	Solenoid Drive Output 4
		16	Solenoid Drive Output 5
		17	Solenoid Drive Output 6
		18	Solenoid Drive Output 7
		19	Solenoid Drive Output 8
		20	Relay 1 Contact b
		21	Relay 2 Contact b
		22	Relay 3 Contact b
		23	Relay 4 Contact b
		24	Relay 5 Contact b
		25	Relay 6 Contact b
		26	Relay 7 Contact b
		27	Relay 8 Contact b
		28	Relay 9 Contact b
		29	Relay 10 Contact b
		30	+24V
		31	+24V
		32	+24V
		33	+24V

<b>Connector Label</b>	<b>Reference Designator</b>	<b>Pin</b>	<b>Signal Description</b>
		34	+24V
		35	+24V
		36	+24V
		37	+24V

---

## **Service Locations**

For additional assistance, service is available from exclusive distributors worldwide. Contact one of the phone numbers below for product support and technical information or visit us on the web at [www.thermo.com/aqi](http://www.thermo.com/aqi).

1-866-282-0430 Toll Free

1-508-520-0430 International

# Chapter 7

## Servicing

This chapter explains how to replace the Model 5014*i* subassemblies. It assumes that a subassembly has been identified as defective and needs to be replaced (or is an “expendable” item, not covered under warranty. Expendable items are indicated with an asterisk (\*) in the “[Model 5014i Replacement Parts](#)” table.

For fault location information, refer to the “[Preventive Maintenance](#)” chapter and the “[Troubleshooting](#)” chapter in this manual.

The service mode section in the “[Operation](#)” chapter also includes parameters and functions that are useful when making adjustments or diagnosing problems.

For additional service assistance, see “[Service Locations](#)” at the end of this chapter.

This chapter includes the following parts information and component replacement procedures:

- “[Safety Precautions](#)” on page 7-3
- “[Firmware Updates](#)” on page 7-4
- “[Accessing the Service Mode](#)” on page 7-4
- “[Replacement Parts List](#)” on page 7-5
- “[Cable List](#)” on page 7-6
- “[External Device Connection Components](#)” on page 7-7
- “[Removing the Measurement Case Assembly and Lowering the Partition Panel](#)” on page 7-9
- “[Fuse Replacement](#)” on page 7-10
- “[Fan/Filter Replacement](#)” on page 7-11
- “[Detector Amplifier Assembly Replacement](#)” on page 7-12
- “[Detector Amplifier Board Calibration](#)” on page 7-13
- “[External Pump Replacement](#)” on page 7-14
- “[Pressure Board Replacement](#)” on page 7-15

- “Pressure Board Calibration” on page 7-17
- “Analog Output Testing” on page 7-18
- “Analog Output Calibration” on page 7-20
- “Analog Input Calibration” on page 7-21
- “Thermistor Replacement” on page 7-23
- “I/O Expansion Board (Optional) Replacement” on page 7-24
- “Digital Output Board Replacement” on page 7-26
- “Motherboard Replacement” on page 7-26
- “Measurement Interface Board Replacement” on page 7-27
- “Photo Interrupt Board Replacement” on page 7-29
- “Proportional Valve Replacement” on page 7-30
- “Detector Assembly Replacement” on page 7-31
- “Flow RTD Replacement” on page 7-33
- “Transformer Replacement” on page 7-34
- “Radius Tube Replacement” on page 7-35
- “Ambient RH/Temperature Replacement” on page 7-36
- “Front Panel Board Replacement” on page 7-38
- “LCD Module Replacement” on page 7-39
- “Service Locations” on page 7-41

## Safety Precautions

Read the safety precautions before beginning any procedures in this chapter.



**WARNING** The service procedures in this manual are restricted to qualified service representatives. ▲

If the equipment is operated in a manner not specified by the manufacturer, the protection provided by the equipment may be impaired. ▲

The detector assembly should be replaced by a qualified technician knowledgeable in dealing with radiation precautions. By removing the detector assembly, the C-14 radioactive source is partially exposed. Safety glasses must be worn during this replacement procedure. The amount of C-14 meets the USNRC regulations as an exempt amount of radioactive source <math><100 \mu\text{Ci}</math>. ▲



**CAUTION** The detector window is very fragile. Handle with great care and do not wipe or touch the window. Furthermore, **do not** touch the solder cable connection (electrode) with your bare fingers. The oils from your skin can damage the detector. ▲

Safety glasses must be worn while replacing the detector assembly. ▲

If the LCD panel breaks, do not let the liquid crystal contact your skin or clothes. If the liquid crystal contacts your skin or clothes, wash it off immediately using soap and water. ▲



**Equipment Damage** Some internal components can be damaged by small amounts of static electricity. A properly grounded antistatic wrist strap must be worn while handling any internal component (Figure 7-1). If an antistatic wrist strap is not available, be sure to touch the instrument chassis before touching any internal components. When the instrument is unplugged, the chassis is not at earth ground. ▲

Do not remove the LCD panel or frame from the LCD module. ▲

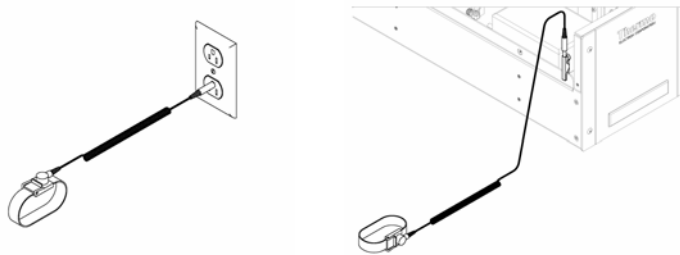
The LCD polarizing plate is very fragile, handle it carefully. ▲

Do not wipe the LCD polarizing plate with a dry cloth, as it may easily scratch the plate. ▲

Do not use alcohol, acetone, MEK or other Ketone based or aromatic solvents to clean the LCD module, but rather use a soft cloth moistened with a naphtha cleaning solvent. ▲

Do not place the LCD module near organic solvents or corrosive gases. ▲

Do not shake or jolt the LCD module. ▲



**Figure 7-1.** Properly Grounded Antistatic Wrist Strap

## Firmware Updates




The firmware can be updated by the user in the field via the serial port or over the Ethernet. This includes both the main processor firmware and the firmware in all low-level processors. Refer to the *iPort* manual for the firmware update procedure.

## Accessing the Service Mode

If the Service menu is not displayed on the Main Menu, use the following procedure to display it.

2. From the Main Menu, choose Instrument Controls > **Service Mode**.

The Service Mode screen appears.

3. Press  to toggle the Service Mode to ON.
4. Press  >  to return to the Main Menu.
5. Return to the procedure.

## Replacement Parts List

Table 7-1 lists the replacement parts for the Model 5014*i* major subassemblies. Refer to Figure 7-2 to identify the component location.

**Table 7-1.** Model 5014*i* Replacement Parts

Part Number	Description
100480-00	Front Panel Pushbutton Board
110570-00	Processor Board (new zPort and *.cramfs required)
100533-00	Motherboard
100539-00	Digital Output Board
100542-00	I/O Expansion Board (optional)
102340-00	Front Panel Connector Board
102496-00	Front Panel Display
106926-00	Transformer, Step-Down, 220-240 VAC (optional)
104290-00	Measurement Interface Board
105869-00	Detector Assembly (LND4335)
105938-00	Photo Interrupt Board Assembly
106611-00	Rear Flow RTD Assembly
106536-00	RH Temperature Assembly
106535-00	Heater Tube Assembly, Three Feet
106037-00	Load Motor Assembly
106032-00	Tape Motor Assembly
106470-00	Proportional Valve Assembly
106946-00	Pressure Board Assembly (w/tubing assembly)
425454008	Preamp Board
106923-00	Pressure Valves
106540-00	Extension tubes w/fitting
101055-00	AC Receptacle Assembly
101681-00	Power Supply Assembly, 24 VDC (with base plate and screws)
101688-00	Ambient Temperature Thermistor (with connector)
100907-00	Fan, 24 VDC
8630	Filter Guard Assembly (with foam)*
109612-00	Fuse, 250 VAC, 10.0 Amp, SlowBlow (for 110 VAC and 115 VAC models)*
109613-00	Fuse, 250 VAC, 5.0 Amp, SlowBlow (for 220-240 VAC models)*

Part Number	Description
10-001403	External Pump Assembly
59-008630	Pump Rebuild Kit
24-000483	Pump Tubing, External 3/8-inch
106994-00	Tubing, Internal 3/8-inch
104401-00	Tape Guides
106443-00	Filter Tape
108183-00	Tape Hardware Kit
112297-00	Replacement O-ring Kit
106531-00	Cover Assembly
106988-00	Handles (front, cover)
FH125C14	Calibration Kit (Cal Foils)
10-000447	Modified Shoe for Tripod
106445-00	Metal Assembly Paste
107000-00	Fitting, 5/8 Union w/Nylon Ferrules
107001-00	Tubing, 5/8 Stainless Steel
109583-00	Roof Flange Assembly

\*Expendable item, not covered by warranty

## Cable List

Table 7–2 lists the Model 5014*i* cables. See the “[Troubleshooting](#)” chapter for associated connection diagrams and board connector pin descriptions.

**Table 7–2.** Model 5014*i* Cables

Part Number	Description
101349-00	AC Power Cable (115 VAC, US)
8926	AC Power Cable (220 VAC, EU)
101036-00	DC Power Supply 24 V Output
101037-00	115 VAC Supply to Measurement Interface Board
101048-00	RS-485/Data
101038-00	AC Power Switch to Motherboard
101364-00	DC Power Supply Status Monitor
101054-00	Motherboard to Front Panel Board
101035-00	DC Power Supply AC Input
101055-00	Main AC from Receptacle Assembly
101377-00	AC to Power Switch



<b>Part Number</b>	<b>Description</b>
101267-00	Fan Power Assembly
106028-00	RH Temperature Connector Assembly
106030-00	Heater Cable to Heater Assembly
106029-00	Pump Cable to Pump Plug Assembly
106844-00	Rear Solenoid Cable Assembly
106027-00	Pressure to Interrupt Board Cable Assembly
105952-00	Cam Photo Interrupt Cable Assembly
106189-00	Counter Wheel Photo Interrupt Cable Assembly
106400-00	External RH Temperature Cable Assembly

## External Device Connection Components

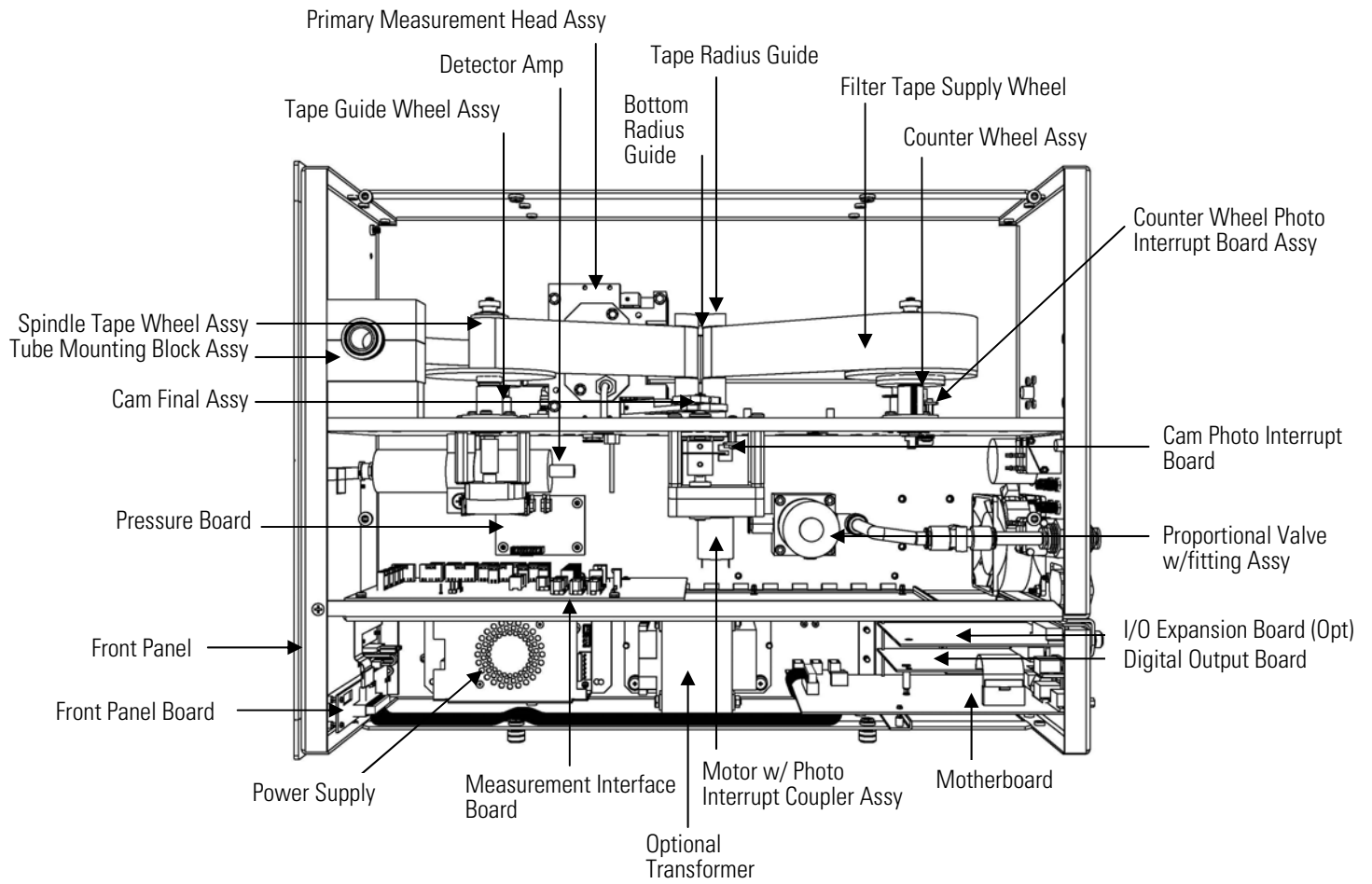
Table 7–3 lists the standard and optional cables and components used for connecting external devices such as PCs and dataloggers to an *iSeries* instrument.

**Table 7–3.** External Device Connection Components

<b>Part Number</b>	<b>Description</b>
102562-00	Terminal Block and Cable Kit (DB25) (optional)
102556-00	Terminal Block and Cable Kit (DB37) (optional)
102645-00	Cable, DB37M to Open End Cable, Six Feet (optional)
102646-00	Cable, DB37F to Open End, Six Feet (optional)
102659-00	Cable, DB25M to Open End, Six Feet (optional)
6279	Cable, RS-232, Six Feet (optional)
102888-00	Terminal Board PCB Assembly, DB37F (standard)
102891-00	Terminal Board PCB Assembly, DB37M (standard)
103084-00	Terminal Board PCB Assembly, DB25M (included with optional I/O Expansion Board)

## Servicing

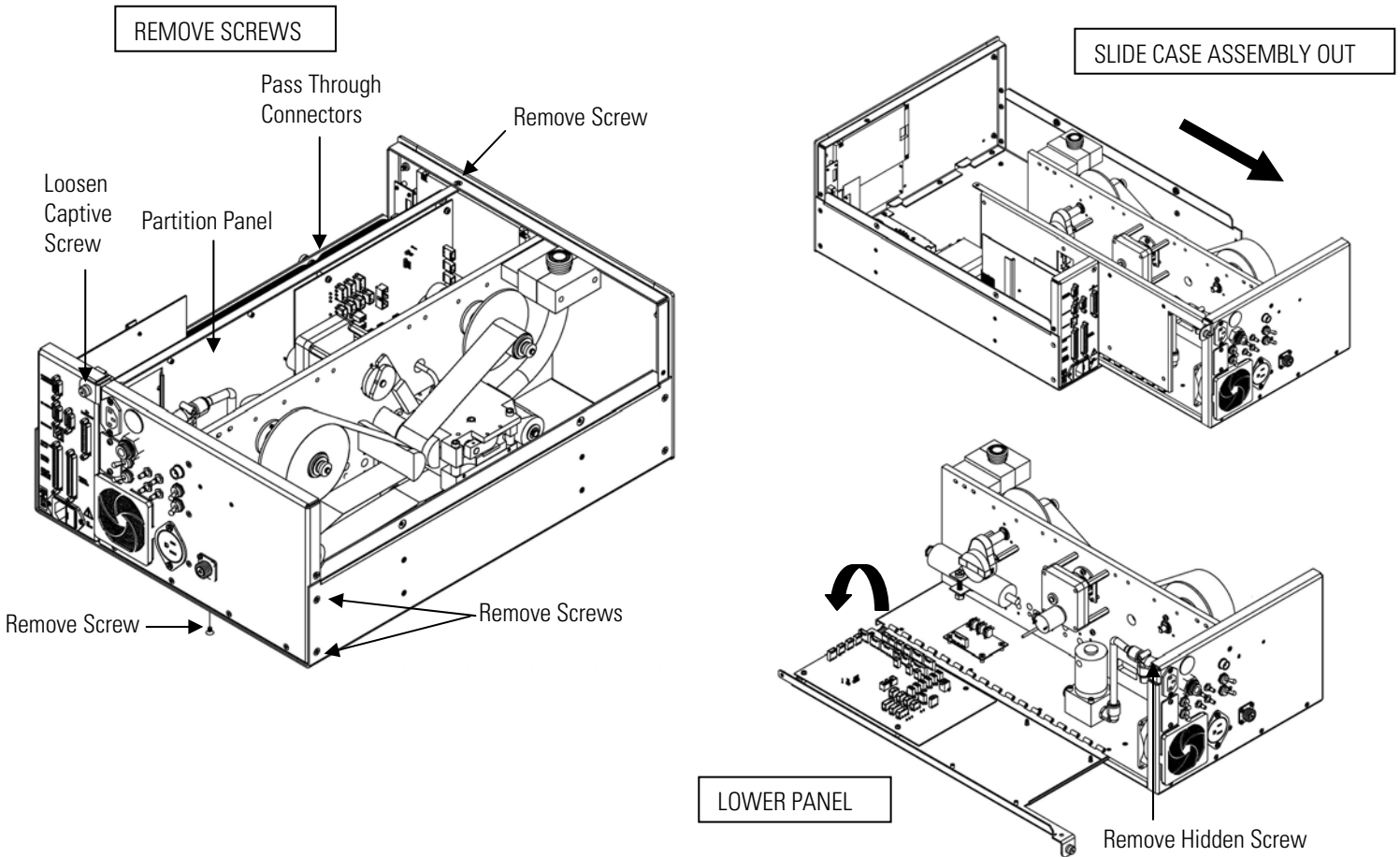
### External Device Connection Components



**Figure 7-2.** Model 5014i Component Layout

# Removing the Measurement Case Assembly and Lowering the Partition Panel

The measurement case assembly can be removed and the partition panel can be lowered to improve access to connectors and components. Refer to the following steps when a procedure requires lowering the partition panel (Figure 7-3).



**Figure 7-3.** Removing the Measurement Case Assembly and Lowering the Partition Panel

Equipment Required:

Philips screwdriver



**Equipment Damage** Some internal components can be damaged by small amounts of static electricity. A properly grounded antistatic wrist strap must be worn while handling any internal component. ▲

## Servicing

### Fuse Replacement

1. Turn the instrument OFF and unplug the power cord.
2. If the instrument is mounted in a rack, remove it from the rack.
3. Remove the cover.
4. Disconnect the plumbing connections at the rear of the measurement case assembly.
5. Disconnect the connectors that pass through the center of the partition panel.
6. Remove two screws from the left side rear of the case (viewed from the front).
7. Remove one screw from the bottom rear of the case.
8. Remove one screw from the top front of the partition panel.
9. While holding the case securely, loosen the captive screw at the rear of the measurement case assembly, and pull the measurement case assembly from the rear of the case.
10. Remove the screw at the top rear of the partition panel that secures the top of the panel to the measurement case assembly, and lower the panel, being careful not to put excessive tension on the cables.
11. Replace the measurement case assembly by following the previous steps in reverse.

## Fuse Replacement

Use the following procedure to replace the fuse.

Equipment Required:

Replacement fuses (refer to the “[Replacement Parts List](#)” in this chapter).

1. Turn the instrument OFF and unplug the power cord.
2. Remove the fuse drawer, located on the AC power connector.

3. If either fuse is blown, replace both fuses.
4. Insert fuse drawer and re-connect power cord.

## Fan/Filter Replacement

Use the following procedure to replace the fan and the fan filter (Figure 7–4).

Equipment Required:

- Fan
- Fan filter
- Philips screwdriver
- Cable cutter (for tie-wrap removal)

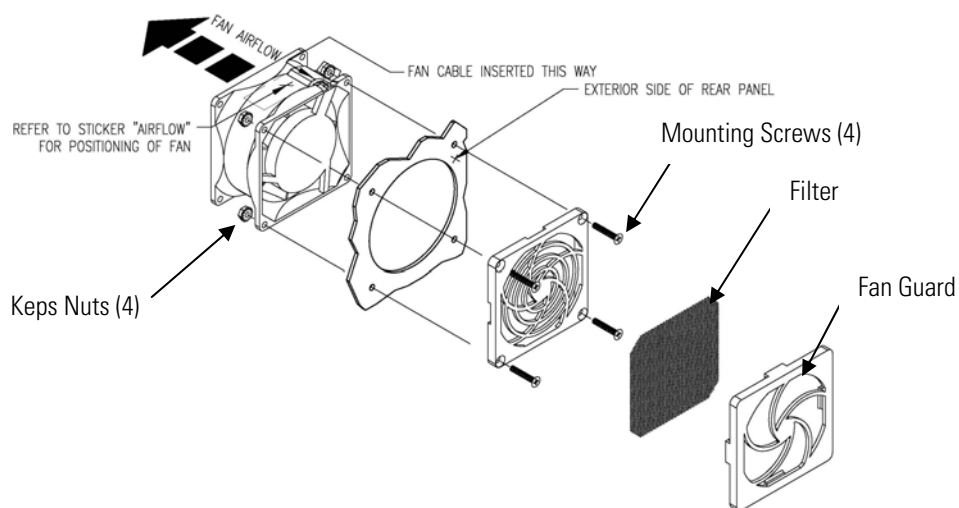


**Equipment Damage** Some internal components can be damaged by small amounts of static electricity. A properly grounded antistatic wrist strap must be worn while handling any internal component. ▲

1. Turn the instrument OFF, unplug the power cord, and remove the cover.
2. Remove the fan guard and filter from the fan by unsnapping it.
3. If the fan is not being replaced, install the new filter, and snap it back into place, and skip the remaining steps.
4. Disconnect the fan power cable from the fan. Do not lose the four nuts.
5. Remove the four fan mounting screws and remove the fan.
6. Install a new fan following the previous steps in reverse.

## Servicing

### Detector Amplifier Assembly Replacement



**Figure 7-4.** Replacing the Fan

## Detector Amplifier Assembly Replacement

Use the following procedure to replace the detector/preamplifier assembly (Figure 7-5).

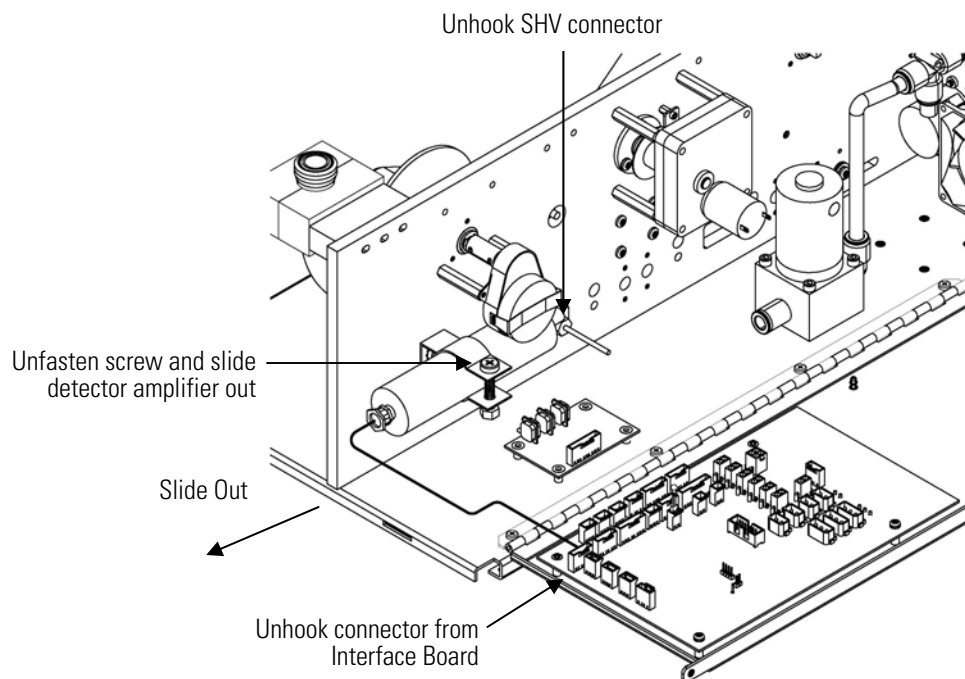
### Equipment Required:

- Detector amplifier assembly
- Philips screwdriver
- Adjustable wrench



**Equipment Damage** Some internal components can be damaged by small amounts of static electricity. A properly grounded antistatic wrist strap must be worn while handling any internal component. ▲

1. Turn the instrument OFF, unplug the power cord, and remove the cover.
2. Disconnect the cable from the detector amplifier assembly connector on the measurement interface board and disconnect the SHV connector from the detector amplifier.
3. Remove the one screw holding the detector amplifier mounting bracket and slide out the detector amplifier assembly.



**Figure 7-5.** Replacing the Detector Amplifier Assembly

4. Install the new detector amplifier assembly by following the previous steps in reverse.
5. Calibrate the detector amplifier board. Refer to the “[Detector Amplifier Board Calibration](#)” procedure that follows.

**Note** If Service Mode is not displayed, refer to “[Accessing the Service Mode](#)” on page 7-4, then return to the beginning of this step. ▲

6. Calibrate the instrument. Refer to the “[Calibration](#)” chapter in this manual.

## Detector Amplifier Board Calibration


Calibrate the detector amplifier after replacing the detector amplifier board.

**Note** This adjustment should only be performed by an instrument service technician. ▲

1. Let the instrument sample zero air for about 90 minutes.

2. From the Main Menu, choose Service > Detector Calibration > **Auto**.  
The Auto Detector Calibration screen appears.

**Note** If Service Mode is not displayed, refer to “[Accessing the Service Mode](#)” on page 7-4, then return to the beginning of this step. ▲

3. At the Detector Calibration screen, press  to start the auto detector calibration.

## External Pump Replacement

Use the following procedure to replace the pump (Figure 7-6).

Equipment Required:

Pump

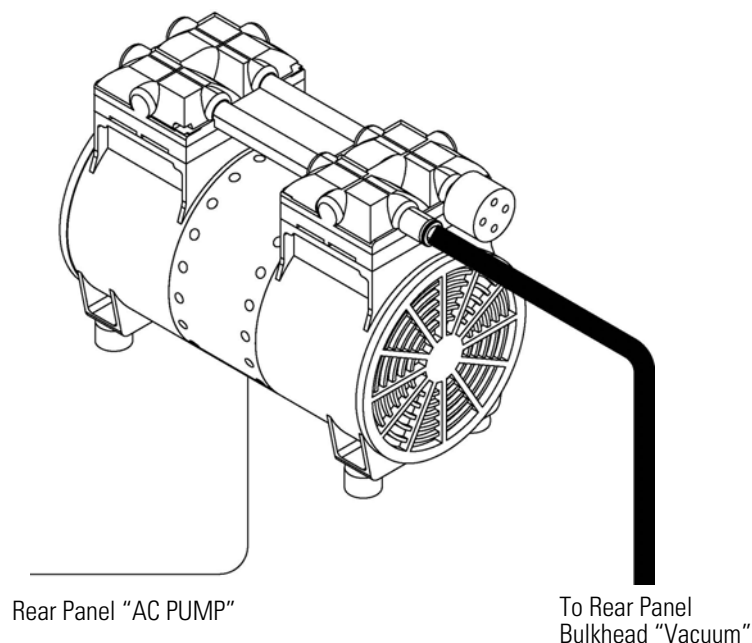
Adjustable wrench



**Equipment Damage** Some internal components can be damaged by small amounts of static electricity. A properly grounded antistatic wrist strap must be worn while handling any internal component. ▲

1. Turn the instrument OFF, unplug the power cord, and remove the cover.
2. Disconnect the pump power cable from the rear panel.
3. Remove both lines from the pump.
4. Install the new pump by following the previous steps in reverse.
5. Perform a leak test as described in the “[Preventive Maintenance](#)” chapter.





**Figure 7-6.** Replacing the Pump

## Pressure Board Replacement

Use the following procedure to replace the pressure board (Figure 7-7).

Equipment Required:

Pressure board

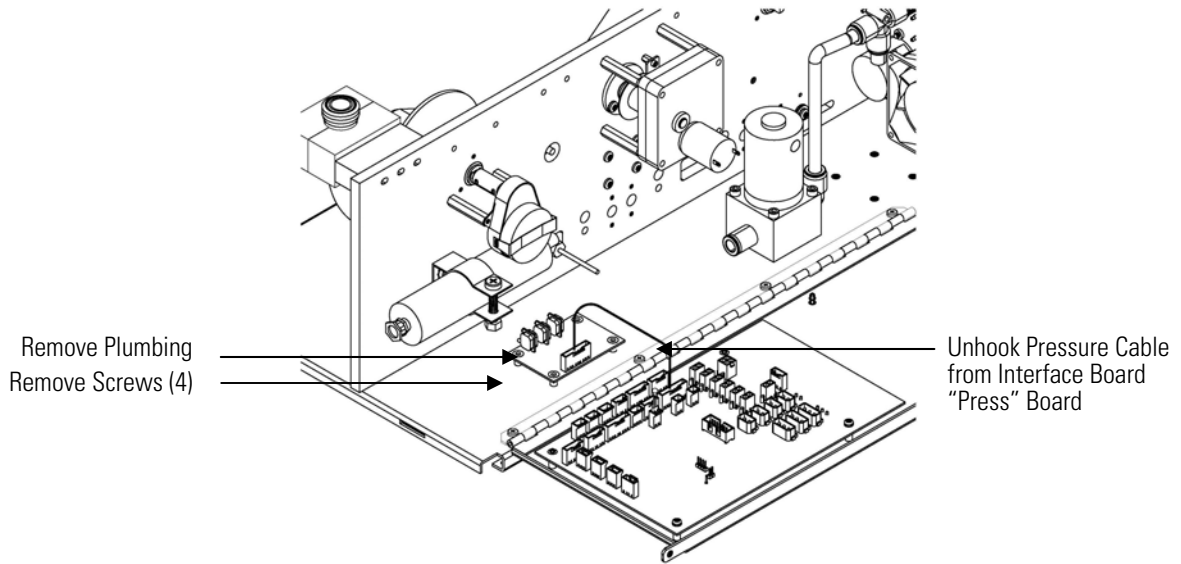
Philips screwdriver, #2



**Equipment Damage** Some internal components can be damaged by small amounts of static electricity. A properly grounded antistatic wrist strap must be worn while handling any internal component. ▲

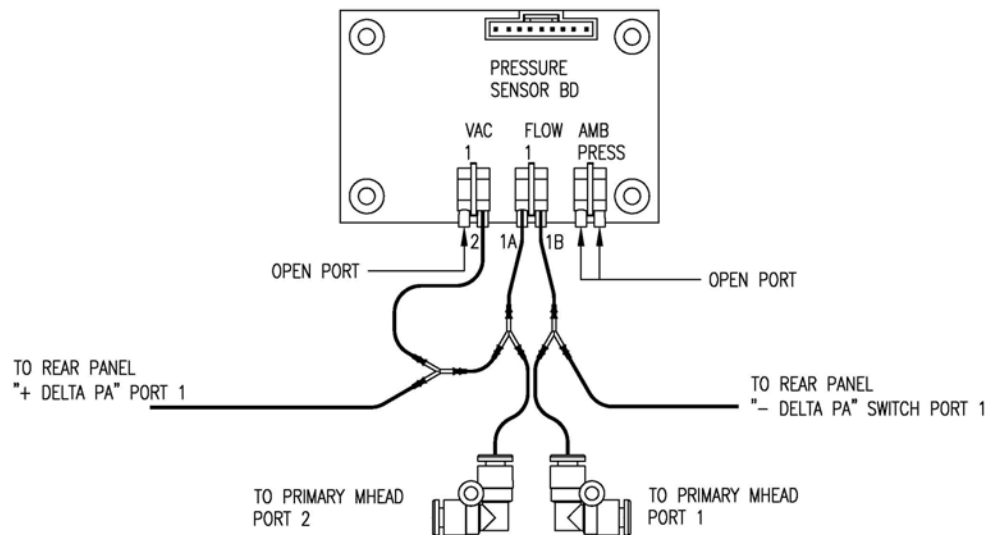
1. Turn the instrument OFF, unplug the power cord, and remove the cover.
2. Disconnect plumbing from the pressure board assembly (Figure 7-2). Note the plumbing connections to facilitate reconnection.
3. Disconnect the pressure board from the floor plate on the measurement interface board.

4. Remove the four pressure board assembly retaining screws and remove the pressure board assembly (Figure 7-7).



**Figure 7-7.** Replacing the Pressure Board Assembly

5. To install the pressure board assembly, follow the previous steps in reverse.



**Figure 7-8.** Replacing the Pressure Board Assembly Plumbing Connection

6. Calibrate the pressure sensor. Refer to the “[Pressure Board Calibration](#)” procedure that follows.
7. After calibration, perform a leak test as described in the “[Preventive Maintenance](#)” chapter.

## Pressure Board Calibration


Use the following procedure to calibrate the pressure board assembly.


Equipment Required:

Manometer

1. From the Main Menu, choose Service > Pres/Vacuum Calibration > **Baro Pres**. Adjust the barometer pressure span by entering the actual barometric pressure value.

**Note** If Service Mode is not displayed, refer to “[Accessing the Service Mode](#)” on page 7-4 , then return to the beginning of this step. ▲

2. Return to the Pres/Vacuum Calibration, choose Vac/Flow > **Flow Pres Span**. Calibrate the flow pressure span according to the following:
  - a. Place digital manometer on bench.
  - b. Turn on manometer and allow to self calibrate. **Do not move** manometer while self-calibrating.
  - c. After zeroing the digital manometer, connect the “+” side of the manometer to the Delta-P  $\boxplus$  port on the rear panel.
  - d. Connect the “-” side of the manometer to the Delta-P  $\boxminus$  port on the rear panel.
  - e. Open both Delta-P  $\boxplus$  and  $\boxminus$  toggle valves to open flow through the manometer.
  - f. Cal Flow Pres Span by entering the actual value read by the manometer.
  - g. Press  to save value.
  - h. Turn off the manometer; this meter does **not** have an automatic turn off feature.
3. Return to the Pres/Vacuum Calibration, choose Vac/Flow > **Vac Pres Span**. Calibrate the vacuum pressure span according to the following:

- a. Use an acceptable vacuum manometer. If using a blue Druck manometer, place blue manometer on bench.
- b. Turn on manometer and let manometer self calibrate. **Do not move** manometer while self-calibrating.
- c. Connect the “+” side of the manometer to the Delta-P  $\bar{\Delta}$ + port on the rear panel.
- d. Open Delta-P  $\bar{\Delta}$ + toggle vales to open flow through the manometer.
- e. Cal Vac Pressure Span by entering the actual value from the reference manometer.
- f. Press  to save value.




## Analog Output Testing



The analog outputs should be tested if the concentration value on the front panel display disagrees with the analog outputs. To check the analog outputs, connect a meter to an analog output channel (voltage or current) and compare the meter reading with the output value set on the Test Analog Outputs screen.

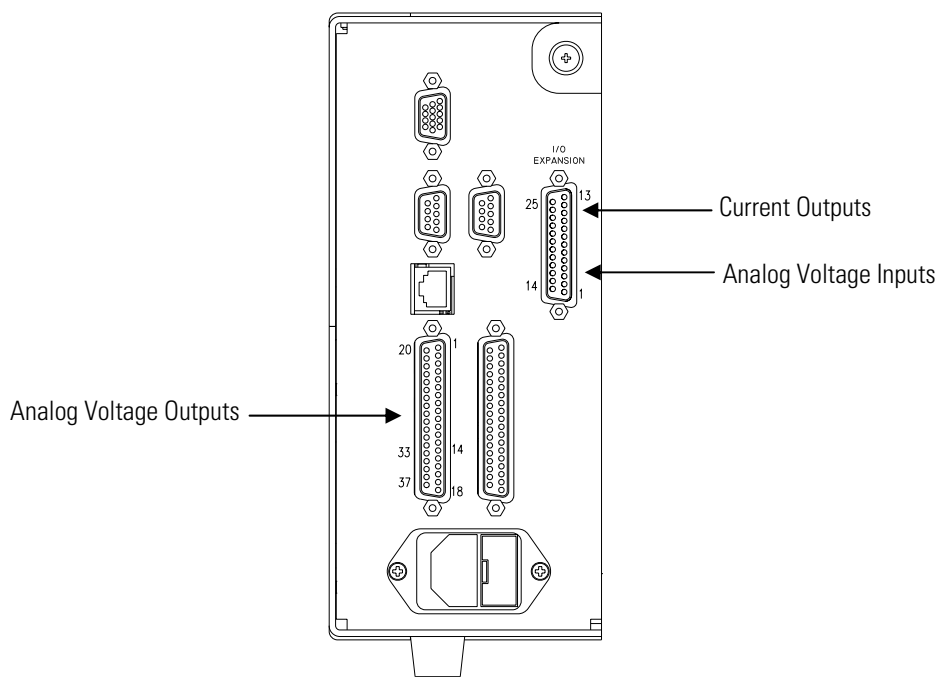
Equipment Required:

Multimeter

Use the following procedure to test the analog outputs.

1. Connect a meter to the channel to be tested. [Figure 7–9](#) shows the analog output pins and [Table 7–4](#) identifies the associated channels.
2. From the Main Menu, choose Diagnostics > **Test Analog Outputs**.  
The Test Analog Outputs screen appears.
3. Press  to scroll to the desired channel corresponding to the rear panel terminal pins where the meter is connected, and press .  
The Set Analog Outputs screen appears.
4. Press  to set the output to zero.  
The Output Set To line displays Zero.
5. Check that the meter is displaying the zero value. If the meter reading differs by more than one percent of the full-scale output, the analog outputs should be adjusted. Refer to the “[Analog Output Calibration](#)” procedure that follows.

6. Press  to set the output to full-scale.  
The Output Set To line displays Full-Scale.
7. Check that the meter is displaying a full-scale value. If the meter reading differs by more than one percent of the full-scale output, the analog outputs should be adjusted. Refer to the “[Analog Output Calibration](#)” procedure that follows.
8. Press  to reset the analog outputs to normal.



**Figure 7–9.** Rear Panel Analog Input and Output Pins

**Table 7–4.** Analog Output Channels and Rear Panel Pin Connections

Voltage Channel	Pin	Current Channel	Pin
1	14	1	15
2	33	2	17
3	15	3	19
4	34	4	21
5	17	5	23
6	36	6	25
Ground	16, 18, 19, 35, 37	Current Output Return	13, 16, 18, 20, 22, 24

**Table 7–5.** Analog Input Channels and Rear Panel Pin Connections

Input Channel	Pin
1	1
2	2
3	3
4	5
5	6
6	7
7	9
8	10
Ground	4, 8, 11, 14

## Analog Output Calibration

Use the following procedure to calibrate the analog outputs if a meter reading in the “[Analog Output Testing](#)” procedure differed by more than one percent or after replacing the optional I/O expansion board.




Equipment Required:

Multimeter

1. Connect a meter to the channel to be adjusted and set to voltage or current as appropriate. [Figure 7–9](#) shows the analog output pins and [Table 7–4](#) identifies the associated channels.
2. From the Main Menu, choose Service > **Analog Out Cal.**










The Analog Output Cal screen appears.

**Note** If Service Mode is not displayed, refer to “[Accessing the Service Mode](#)” on page 7-4, then return to the beginning of this step. ▲

3. At the Analog Output Cal menu, press  to scroll to the desired voltage channel or current channel corresponding to the rear panel terminal pin where the meter is connected, then press .
4. With the cursor at Calibrate Zero, press .

The Analog Output Cal line displays Zero.

**Note** When calibrating the analog output, always calibrate zero first and then calibrate full-scale. ▲

5. Use   until the meter reads the value shown in the Set Output To line (0.0 V, or 0.0 or 4.0 mA), then press  to save the value.
6. Press  to return to the previous screen.
7. Press   to select Calibrate Full-Scale.
8. Use   until the meter reads the value shown in the Set Output To line, then press  to save the value.

## Analog Input Calibration

Use the following procedures to calibrate the analog inputs after replacing the optional I/O expansion board. These procedures include selecting analog input channels, calibrating them to zero volts, and then calibrating them to full-scale using a known voltage source.







### Calibrating the Input Channels to Zero Volts

Use the following procedure to calibrate the input channels to zero volts.

1. From the Main Menu, choose Service > **Analog Input Cal.**

The Analog Input Cal screen appears.

**Note** If Service Mode is not displayed, refer to “[Accessing the Service Mode](#)” on page 7-4, then return to the beginning of this step. ▲





2. At the Analog Input Cal screen, press  to scroll to a channel, and press .
3. With the cursor at Calibrate Zero, press .  
The screen displays the input voltage for the selected channel.
4. Make sure that nothing is connected to the channel input pins and press  to calibrate the input voltage on the selected channel to zero volts.  
The screen displays 0.00 V as the voltage setting.
5. Press  >  to return to the Analog Input Cal screen and repeat Steps 2 through 4 to calibrate other input channels to zero as necessary.
6. Continue with the “[Calibrating the Input Channels to Full-Scale](#)” procedure that follows.

## Calibrating the Input Channels to Full-Scale








Use the following procedure to calibrate the input channels to full-scale by applying a known voltage to the channels.

Equipment Required:

DC voltage source (greater than 0 volts and less than 10 volts)

1. Connect the known DC voltage source to the input channel (1-8) to be calibrated. [Figure 7-9](#) shows the analog input pins and [Table 7-5](#) identifies the associated channels.
2. From the Main Menu, choose Service > **Analog Input Cal**.  
The Analog Input Cal screen displays input channels 1-8.
3. At the Analog Input Cal screen, press  to scroll to the channel selected in Step 1, and press .
4. Press  to scroll to Calibrate Full-scale, and press .  
The screen displays the input voltage for the selected channel.



5. Use   and   to enter the source voltage, and press  to calibrate the input voltage for the selected channel connected to the source voltage.
6. Press  >  to return to the input channels display and repeat Steps 3-5 to calibrate other input channels to the source voltage as necessary.

## Thermistor Replacement

Use the following procedure to replace the optional ambient temperature thermistor (Figure 7-10).

Equipment Required:

Thermistor assembly

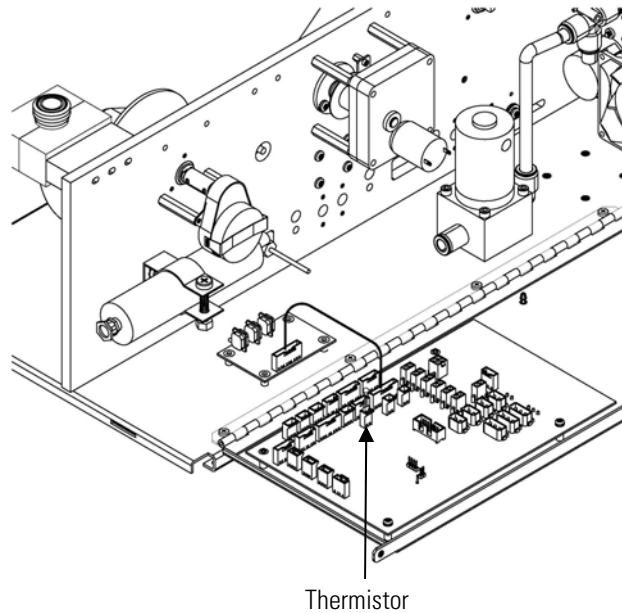


**Equipment Damage** Some internal components can be damaged by small amounts of static electricity. A properly grounded antistatic wrist strap must be worn while handling any internal component. ▲

1. Turn the instrument OFF, unplug the power cord, and remove the cover.
2. Squeeze the thermistor latch and pull the thermistor assembly from the AMB TEMP connector on the measurement interface board.
3. Snap the new thermistor into the AMB TEMP connector.

## Servicing

### I/O Expansion Board (Optional) Replacement



**Figure 7-10.** Replacing the Thermistor

## I/O Expansion Board (Optional) Replacement

Use the following procedure to replace the optional I/O expansion board (Figure 7-11).

Equipment Required:

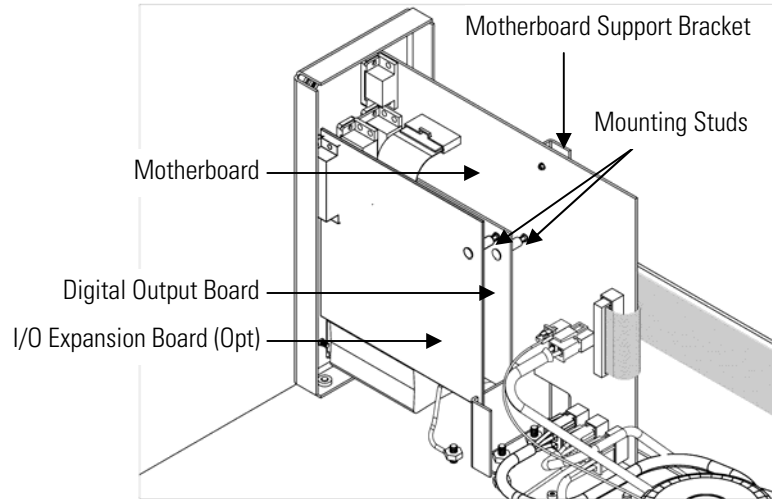
- I/O expansion board
- Nut driver, 3/16-inch



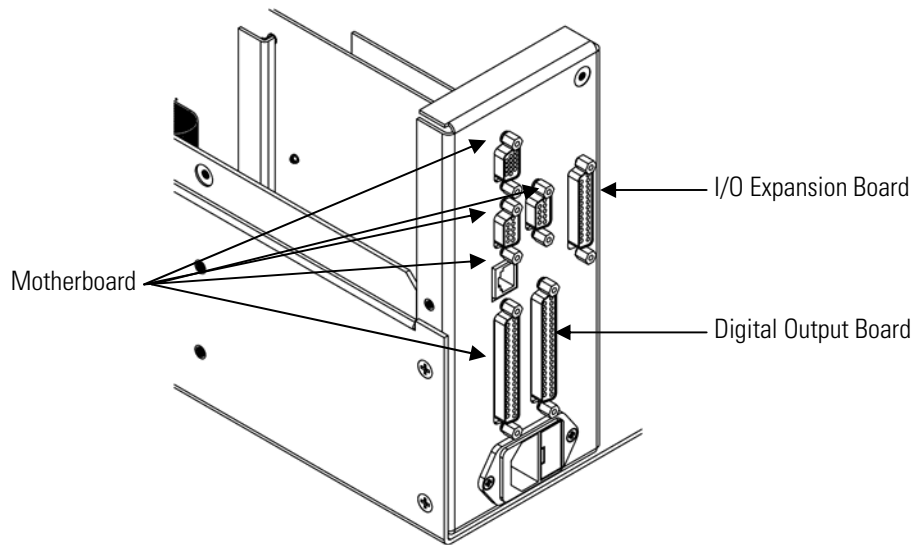
**Equipment Damage** Some internal components can be damaged by small amounts of static electricity. A properly grounded antistatic wrist strap must be worn while handling any internal component. ▲

1. Turn the instrument OFF, unplug the power cord, and remove the cover.
2. Unplug the I/O expansion board cable from the EXPANSION BD connector on the motherboard.
3. Remove the two standoffs holding the I/O expansion board connector to the rear panel (Figure 7-12).
4. Pop the board off of the mounting studs and remove the board.

5. To install the I/O expansion board, follow the previous steps in reverse.
6. Calibrate the analog current outputs and analog voltage inputs as defined earlier in this chapter.



**Figure 7–11.** Replacing the I/O Expansion Board (Optional)



**Figure 7–12.** Rear Panel Board Connectors

## Digital Output Board Replacement

Use the following procedure to replace the digital output board ([Figure 7–11](#)).

Equipment Required:

Digital output board

Nut driver, 3/16-inch



**Equipment Damage** Some internal components can be damaged by small amounts of static electricity. A properly grounded antistatic wrist strap must be worn while handling any internal component. ▲

1. Turn the instrument OFF, unplug the power cord, and remove the cover.
2. Remove the I/O expansion board (optional), if used. See the “[I/O Expansion Board \(Optional\) Replacement](#)” procedure in this chapter.
3. Disconnect the digital output board ribbon cable from the motherboard.
4. Using the nut driver, remove the two standoffs securing the board to the rear panel ([Figure 7–12](#)).
5. Pop the digital output board off of the mounting studs and remove the board.
6. To install the digital output board, follow the previous steps in reverse.

## Motherboard Replacement

Use the following procedure to replace the motherboard ([Figure 7–11](#)).

Equipment Required:

Motherboard

Philips screwdriver

Nut driver, 3/16-inch



**Equipment Damage** Some internal components can be damaged by small amounts of static electricity. A properly grounded antistatic wrist strap must be worn while handling any internal component. ▲

1. Turn the instrument OFF, unplug the power cord, and remove the cover.
2. Remove the I/O expansion board (optional), if used. See the “[I/O Expansion Board \(Optional\) Replacement](#)” procedure in this chapter.
3. Remove the digital output board. See the “[Digital Output Board Replacement](#)” procedure in this chapter.
4. Unplug all connectors from the motherboard. Note connector locations to facilitate re-connection.
5. Using the nut driver, remove the six standoffs securing the board to the rear panel ([Figure 7–12](#)).
6. Pop the motherboard off of the support bracket, and remove the motherboard.
7. To install the motherboard, follow the previous steps in reverse.
8. Calibrate the analog voltage outputs as defined earlier in this chapter (all ranges).

## Measurement Interface Board Replacement

Use the following procedure to replace the measurement interface board ([Figure 7–13](#)).

Equipment Required:

Measurement interface board

Philips screwdriver

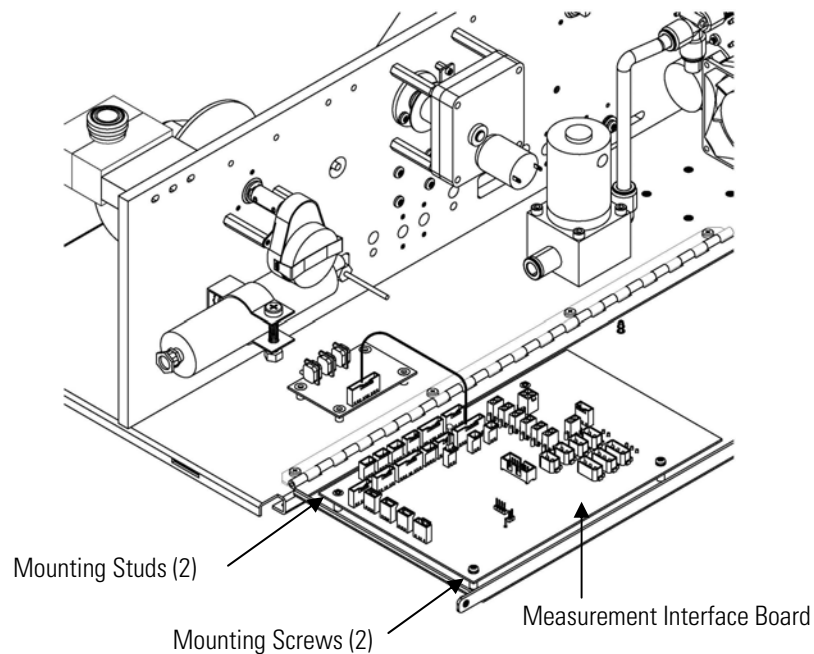


**Equipment Damage** Some internal components can be damaged by small amounts of static electricity. A properly grounded antistatic wrist strap must be worn while handling any internal component. ▲

## Servicing

### Measurement Interface Board Replacement

1. Lower the partition panel, then proceed to the next step below. Refer to “[Removing the Measurement Case Assembly and Lowering the Partition Panel](#)” in this chapter.
2. Unplug all connectors from the measurement interface board. Note the locations of the connectors to facilitate re-connection.
3. Unscrew the two screws at the top of the measurement interface board. Pop the measurement interface board off from the two bottom mounting studs and remove the board.
4. To install the measurement interface board, follow the previous steps in reverse.
5. Re-install the measurement case assembly.
6. Calibrate the instrument. Refer to the “[Calibration](#)” chapter in this manual.



**Figure 7–13.** Replacing the Measurement Interface Board

## Photo Interrupt Board Replacement

Use the following procedure to replace the photo interrupt board (Figure 7-14).

Equipment Required:

Photo interrupt board

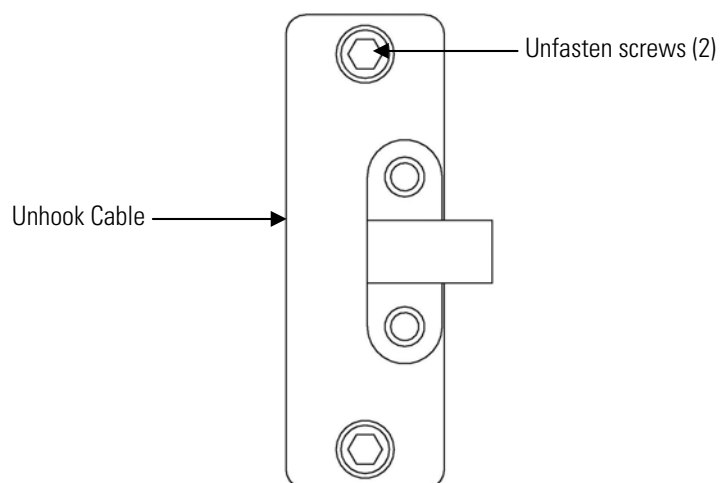
Hex driver, 3/32-inch

Philips head screwdriver, #1



**Equipment Damage** Some internal components can be damaged by small amounts of static electricity. A properly grounded antistatic wrist strap must be worn while handling any internal component. ▲

1. Turn the instrument OFF, unplug the power cord, and remove the cover.
2. Disconnect cable.
3. Remove mounting screws.
4. Remove board.
5. Re-install the photo interrupt board by following the previous steps in reverse.



**Figure 7-14.** Replacing the Photo Interrupt Board

## Proportional Valve Replacement

Use the following procedure to replace the proportional valve (Figure 7–15).

Equipment Required:

Proportional valve assembly

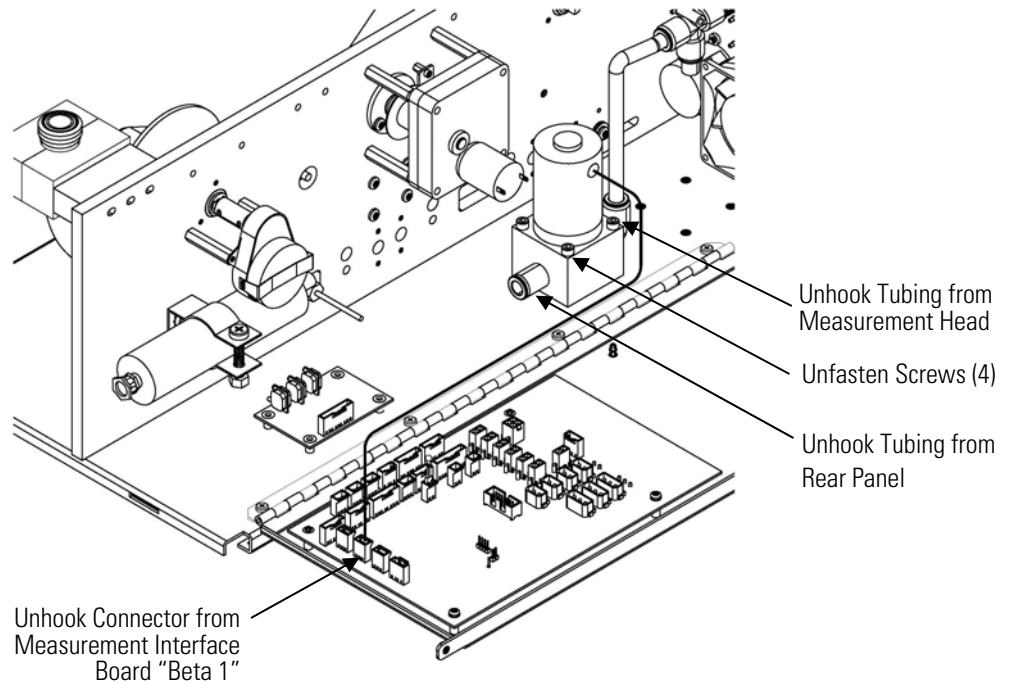
Hex driver, 3/32-inch



**Equipment Damage** Some internal components can be damaged by small amounts of static electricity. A properly grounded antistatic wrist strap must be worn while handling any internal component. ▲

1. Turn the instrument OFF, unplug the power cord, and remove the cover.
2. Refer to “[Removing the Measurement Case Assembly and Lowering the Partition Panel](#)” in this chapter to lower the partition panel, then proceed to the next step below.
3. Disconnect connector from the measurement interface board.
4. Disconnect plumbing.
5. Remove four mounting screws and remove proportional valve assembly.
6. Replace the proportional valve assembly by following the previous steps in reverse.
7. Perform a leak test as described in the “[Preventive Maintenance](#)” chapter.





**Figure 7–15.** Replacing the Proportional Valve

## Detector Assembly Replacement

Use the following procedure to replace the detector assembly (Figure 7–16).

### Equipment Required:

- Detector assembly
- Hex driver, 4 mm
- Safety glasses



**WARNING** The detector assembly should be replaced by a qualified technician knowledgeable in dealing with radiation precautions. By removing the detector assembly, the C-14 radioactive source is partially exposed. Safety glasses must be worn during this replacement procedure. The amount of C-14 meets the USNRC regulations as an exempt amount of radioactive source <math><100 \mu\text{Ci}</math>. ▲

The service procedures in this manual are restricted to qualified representatives. ▲

If the equipment is operated in a manner not specified by the manufacturer, the protection provided by the equipment may be impaired. ▲



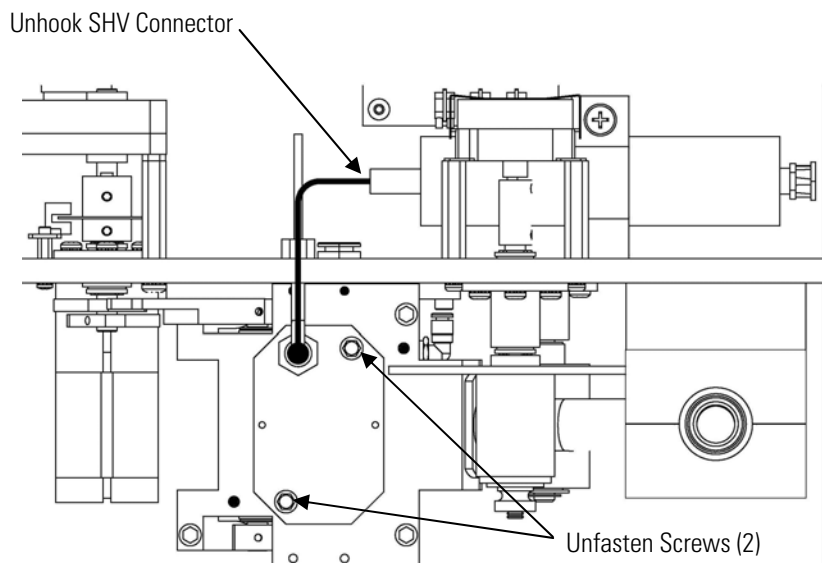
**CAUTION** The detector window is very fragile. Handle with great care and do not wipe or touch the window. Furthermore, **do not** touch the solder cable connection (electrode) with your bare fingers. The oils from your skin can damage the detector. ▲

Safety glasses must be worn while replacing the detector assembly. ▲



**Equipment Damage** Some internal components can be damaged by small amounts of static electricity. A properly grounded antistatic wrist strap must be worn while handling any internal component. ▲

1. Turn the instrument OFF, unplug the power cord, and remove the cover.
2. Disconnect the SHV connector from the detector amplifier assembly and slide through the wall plate.
3. Loosen both detector mounting screws and slowly lift the detector assembly.
4. Install the new detector assembly by following the previous steps in reverse, while taking special care not to puncture the mylar.
5. Calibrate the detector assembly. Refer to the “[Detector Calibration](#)” procedure on page [4-12](#).



**Figure 7–16.** Replacing the Detector Assembly

## Flow RTD Replacement

Use the following procedure to replace the flow resistive temperature diction (RTD) (see [Figure 7–17](#)).

Equipment Required:

Sample flow RTD

Adjustable wrench



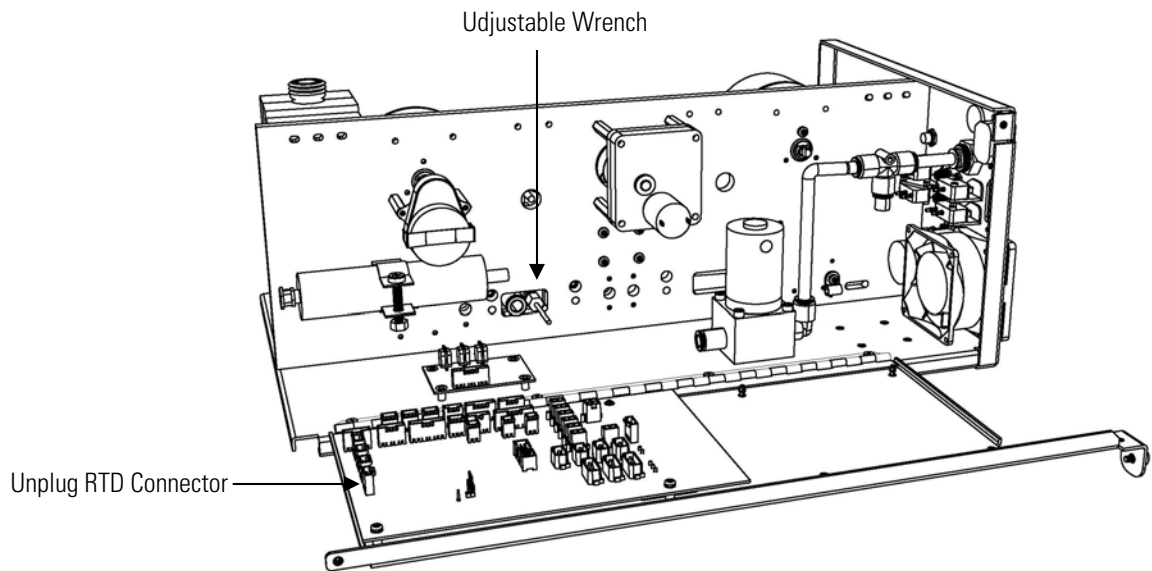
**Equipment Damage** Some internal components can be damaged by small amounts of static electricity. A properly grounded antistatic wrist strap must be worn while handling any internal component. ▲

1. Turn the instrument OFF, unplug the power cord, and remove the cover.
2. Refer to “[Removing the Measurement Case Assembly and Lowering the Partition Panel](#)” in this chapter to lower the partition panel, then proceed to the next step below.
3. Loosen the kynar fittings using the wrench and slide out sample flow RTD.
4. Unplug the RTD connector from the measurement interface board “flowtemp1”.

5. Carefully install the new RTD by following the previous steps in reverse. Match the marked black line on the RTD to be flush with the fitting.

**Note** The black line is the pre-measured depth for the RTD. ▲

6. Calibrate the instrument. Refer to the “[Calibration](#)” chapter in this manual.



**Figure 7–17.** Replacing the RTD

## Transformer Replacement

Use the following procedure to replace the transformer ([Figure 7–18](#)).

Equipment Required:

Transformer assembly

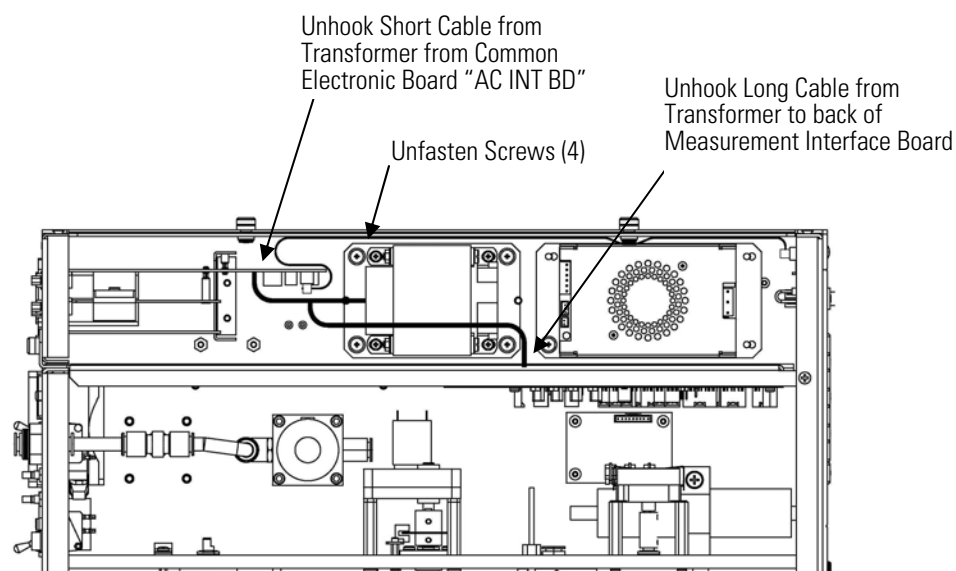
Philips screwdriver, #2



**Equipment Damage** Some internal components can be damaged by small amounts of static electricity. A properly grounded antistatic wrist strap must be worn while handling any internal component. ▲

1. Turn the instrument OFF, unplug the power cord, and remove the cover.

2. Disconnect cables from the measurement interface board and motherboard.
3. Unscrew the four mounting screws and lift out the transformer assembly.
4. Install the new transformer by following the previous steps in reverse.



**Figure 7–18.** Replacing the Transformer

## Radius Tube Replacement

Use the following procedure to replace the radius tube (Figure 7–19).

Equipment Required:

- Radius tube assembly
- Hex driver, 9/16-inch
- Hex driver, 7/64-inch



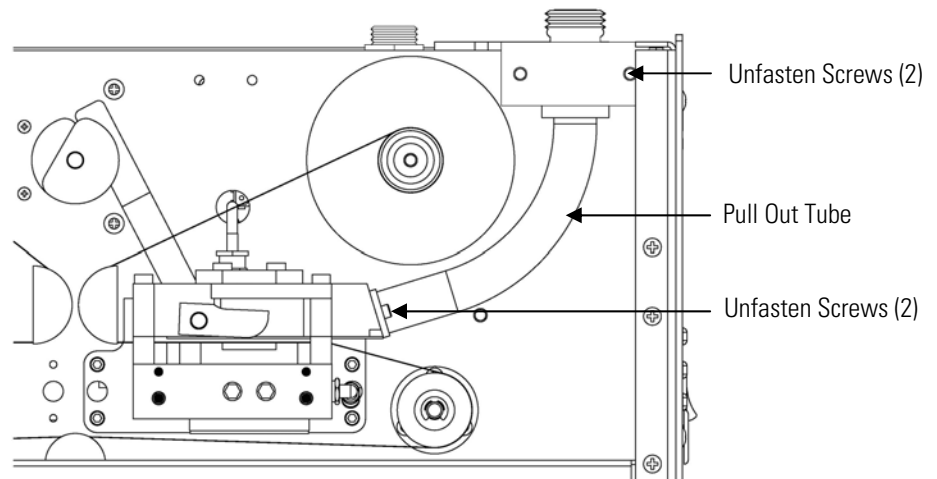
**Equipment Damage** Some internal components can be damaged by small amounts of static electricity. A properly grounded antistatic wrist strap must be worn while handling any internal component. ▲

1. Turn the instrument OFF, unplug the power cord, and remove the cover.

## Servicing

### Ambient RH/Temperature Replacement

2. Loosen the two screws of the radius mounting block using a 9/16-inch hex driver.
3. Loosen the two mounting screws on the measurement head assembly. Remove tube by slightly turning side-to-side, while pulling.
4. Verify the sealing o-ring is in position before sliding the new radius tube assembly into the measurement head.
5. Install the new radius tube assembly by following the previous steps in reverse.



**Figure 7–19.** Replacing the Radius Tube

## Ambient RH/Temperature Replacement

Use the following procedure to replace the ambient RH/temperature assembly (Figure 7–20).

Equipment Required:

Ambient RH/temperature assembly

Adjustable wrench

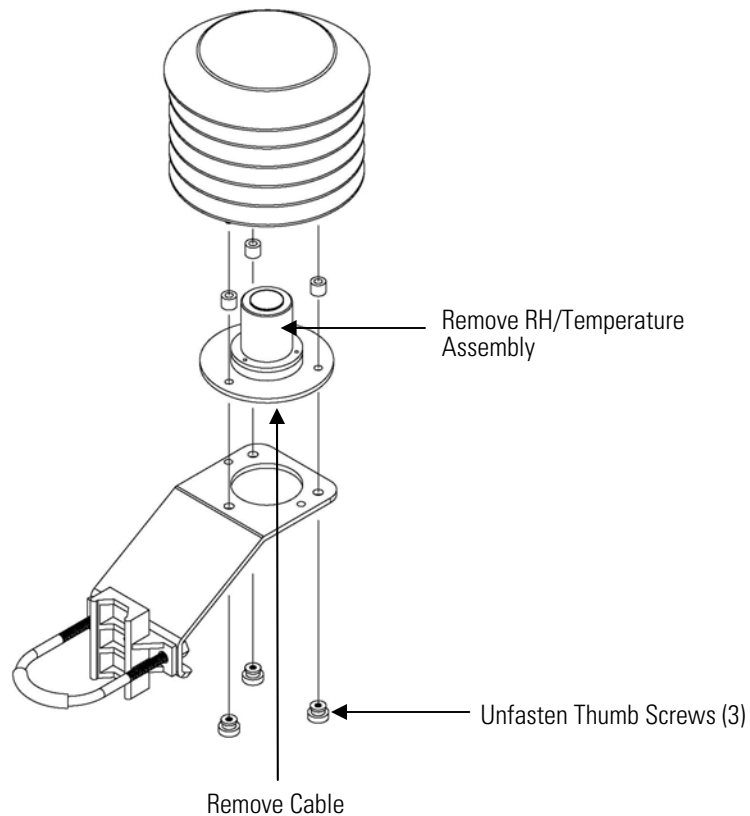
Pliers

**Equipment Damage** Some internal components can be damaged by small amounts of static electricity. A properly grounded antistatic wrist strap must be worn while handling any internal component. ▲

1. Turn the instrument OFF, unplug the power cord, and remove the cover.
2. Remove the cable from the bottom of the radiation shield assembly that houses the ambient RH/temperature assembly.
3. Remove the two mounting nuts on the mounting clamp of the radiation shield assembly. Remove the radiation shield assembly.
4. Turn over the radiation shield assembly and remove the three thumb screws.
5. Remove the three spacers and mounting bracket.
6. Slide out the ambient RH/temperature assembly.
7. Slide in the new ambient RH/temperature assembly by following the previous steps in reverse.
8. Calibrate the instrument. Refer to the “[Calibration](#)” chapter in this manual.

## Servicing

### Front Panel Board Replacement



**Figure 7–20.** Replacing the Ambient RH/Temperature Assembly

## Front Panel Board Replacement

Use the following procedure to replace the front panel board (Figure 7–21).

Equipment Required:

Front panel board

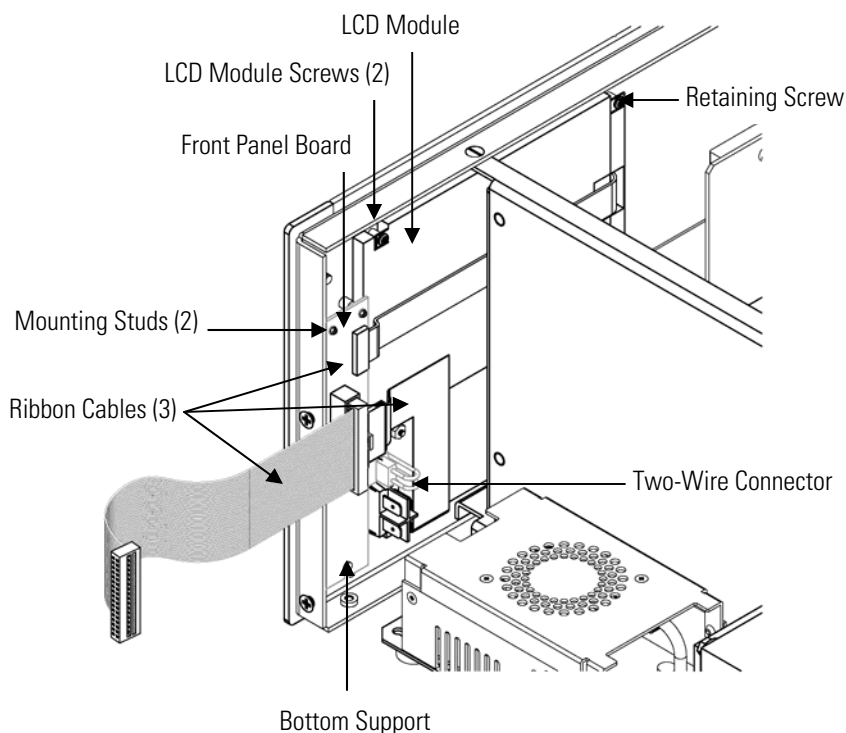


**Equipment Damage** Some internal components can be damaged by small amounts of static electricity. A properly grounded antistatic wrist strap must be worn while handling any internal component. ▲

1. Turn the instrument OFF, unplug the power cord, and remove the cover.
2. Remove the three ribbon cables and the two-wire connector from the front panel board.



3. Pop the board off of the two top mounting studs and remove the board by lifting it up and off the slotted bottom support.
4. Replace the front panel board by following the previous steps in reverse.



**Figure 7–21.** Replacing the Front Panel Board and the LCD Module

## LCD Module Replacement

Use the following procedure to replace the LCD module ([Figure 7–21](#)).

Equipment Required:

LCD module

Philips screwdriver



**CAUTION** If the LCD panel breaks, do not let the liquid crystal contact your skin or clothes. If the liquid crystal contacts your skin or clothes, wash it off immediately using soap and water. ▲



**Equipment Damage** Some internal components can be damaged by small amounts of static electricity. A properly grounded antistatic wrist strap must be worn while handling any internal component. ▲

Do not remove the LCD panel or frame from the LCD module. ▲

The LCD polarizing plate is very fragile, handle it carefully. ▲

Do not wipe the LCD polarizing plate with a dry cloth, as it may easily scratch the plate. ▲

Do not use alcohol, acetone, MEK or other Ketone based or aromatic solvents to clean the LCD module, but rather use a soft cloth moistened with a naphtha cleaning solvent. ▲

Do not place the LCD module near organic solvents or corrosive gases. ▲

Do not shake or jolt the LCD module. ▲

1. Turn the instrument OFF, unplug the power cord, and remove the cover.
2. Disconnect the ribbon cable and the two-wire connector from the front panel board.
3. Remove the four screws at the corners of the LCD module.
4. Slide the LCD module out towards the center of the instrument.
5. Replace the LCD module by following the previous steps in reverse.

**Note** The optimal contrast will change from one LCD screen to another. After replacing the LCD screen, the contrast may need to be reset. If the content on the screen is visible, select Instrument Controls > **Screen Contrast** and adjust the screen contrast. If the content on the screen is not visible, use the “set contrast 10” C-Link command to set screen contrast to mid range, then optimize the contrast. See the “[C-Link Protocol Commands](#)” appendix for more information on this command. ▲

## **Service Locations**

For additional assistance, service is available from exclusive distributors worldwide. Contact one of the phone numbers below for product support and technical information or visit us on the web at [www.thermo.com/aqi](http://www.thermo.com/aqi).

1-866-282-0430 Toll Free

1-508-520-0430 International



# Chapter 8

## System Description

This chapter describes the function and location of the system components, provides an overview of the firmware structure, and includes a description of the system electronics and input/output connections and functions as follows:

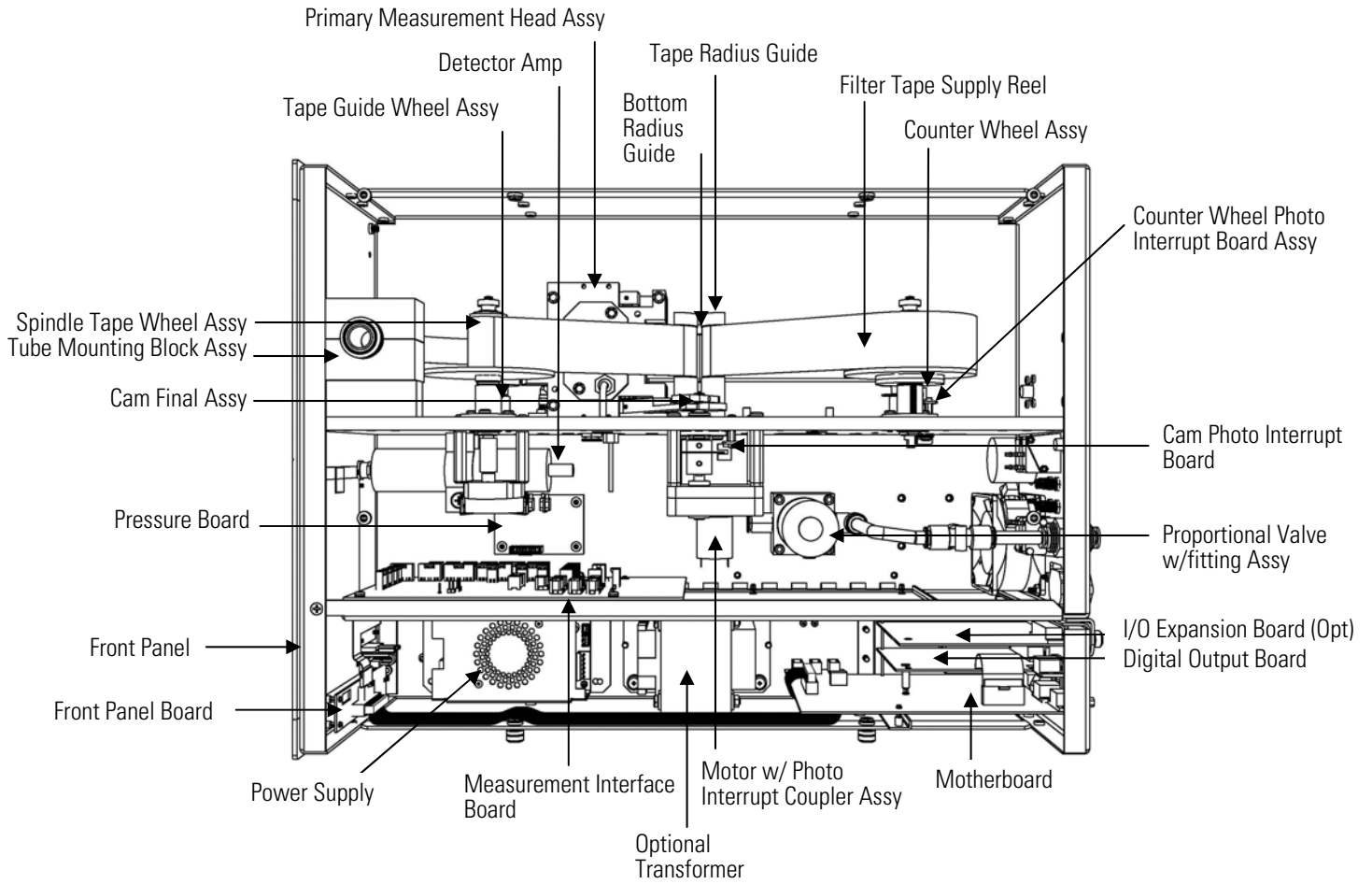
- “[Hardware](#)” on page 8-1
- “[Firmware](#)” on page 8-4
- “[Electronics](#)” on page 8-5
- “[I/O Components](#)” on page 8-7

### Hardware

Model 5014*i* hardware (Figure 8-1) includes:

- Primary measurement head
- Detector amplifier
- Cam photo interrupt board assembly
- Counter wheel interrupt board assembly
- Proportional valve
- Cam motor
- Tape motor
- Pressure board

**System Description**  
Hardware



**Figure 8-1.** Hardware Components

## **Primary Measurement Head**

The primary measurement head uses a beta source and proportional alpha/beta detector to measure the attenuation of beta particles by sampled aerosol across a glass fiber filter and to discriminate against any naturally occurring beta interferences from the daughter nuclides of alpha decay products.

## **Detector Amplifier**

This cylindrical tube houses a printed circuit board, provides power to the proportional detector and amplifies the beta and alpha counts prior to being sent to the 5014*i* measurement interface board.

## **Cam Photo Interrupt Board**

This small printed circuit board includes a photo-interrupter to detect the closed position of the measurement head. This is connected to a motor assembly used to open and close the measurement head.

## **Counter Wheel Interrupt Board Assembly**

This small printed circuit board is mounted onto a chopper wheel that measures the amount of filter tape advanced during a filter tape change.

## **Proportional Valve**

The proportional valve is a proportional solenoid valve that is used as a means of flow control. In response to the measured flow across a subsonic orifice, the proportional valve will either partially open or close to make a flow adjustment in real-time.

## **Cam Motor**

This motor is used to drive the cam to rotate. By rotating the cam, the measurement head lever arm is raised and lowered for opening and closing the measurement head during a filter tape change.

## **Tape Motor**

After the measurement head is opened, this motor is used to advance the filter tape a fixed amount prior to initiating another beta attenuation event on a fixed sample spot.

## **Pressure Board**

This PCB assembly is mounted on the floor plate and has three pressure sensors attached. The pressure board is used to measure the barometric pressure, differential pressure across the orifice and vacuum under the filter tap. All tubing attached to the pressure board is numbered in case of the need to swap out this board.

## **Firmware**

The processor firmware tasks are organized into four areas:

- Instrument control
- Monitoring signals
- Measurement calculations
- Output communication

## **Instrument Control**

Low-level embedded processors are used to control the various functions on the boards, such as analog and digital I/O. These processors are controlled over a serial interface with a single high-level processor that also controls the front-panel user interface. The low-level processors all run a common piece of firmware that is bundled with the high-level firmware and loaded on power-up if a different version is detected.

Each board has a specific address that is used to identify to the firmware what functions are supported on that board. This address is also used for the communications between the low-level processors and the high-level processor.

Every tenth of a second, the frequency counters, analog I/O, and digital I/O are read and written to by the low-level processors. The counters are accumulated over the past second and the analog inputs are averaged over that second. The high-level processor polls the low-level processors once per second to exchange the measurement and control data.

## **Monitoring Signals**

Signals are gathered from the low-level processors once per second, and then processed by the high-level processor to produce the final measurement values. The one-second accumulated counts are accumulated and reported for the user-specified averaging time. If this averaging time is greater than ten seconds, the measurement is still reported every 10 seconds. The one-second average of the other analog inputs are reported directly (no additional signal conditioning is performed by the high-level processor).

## **Output Communication**

The front panel display, serial and Ethernet data ports, and analog outputs are the means of communicating the results of the above calculations. The front panel display presents the concentrations simultaneously. The display is updated every 1-10 seconds, depending on the averaging time.

The analog output ranges are user selectable via firmware. The analog outputs are defaulted based on the measurement range. Negative



concentrations can be represented as long as they are within -5% of full-scale. The zero and span values may be set by the user to any desired value.

## **Electronics**

All electronics operate from a universal switching supply, which is capable of auto-sensing the input voltage and working over the all specified ranges.

External pumps and heaters all operate on 110 VAC. An optional transformer is required if operating on the 210-250 range.

An on/off switch controls all power to the analyzer and is accessible on the front panel.

## **Motherboard**

The motherboard contains the main processor, power supplies, and a sub-processor, and serves as the communication hub for the instrument. The motherboard receives operator inputs from the front panel function keys and/or over I/O connections on the rear panel. The motherboard sends commands to the other boards to control the functions of the instrument and to collect measurement and diagnostic information. The motherboard outputs instrument status and measurement data to the graphics display and to the rear-panel I/O. The motherboard also contains I/O circuitry and the associated connector to monitor external digital status lines and to output analog voltages that represent the measurement data. Connectors located on the motherboard include:

External connectors include:

- External Accessory
- RS-232/485 Communications (two connectors)
- Ethernet Communications
- I/O connector with Power Fail Relay, 16 Digital Inputs, and 6 Analog Voltage Outputs.

Internal connectors include:

- Function Key Panel and Display
- Measurement Interface Board
- I/O Expansion Board
- Digital Output Board
- AC Distribution

**Measurement Interface Board** The measurement interface board serves as a central connection area for all measurement electronics in the instrument. It contains power supplies and interface circuitry for sensors and control devices in the measurement system. It sends status data to the motherboard and receives control signals from the motherboard.

**Measurement Interface Board Connectors** Connectors located on the measurement interface board include:

- Data communication with the motherboard
- 24 V and 120 VAC power supply inputs
- Fan and solenoid outputs
- 120 VAC output and thermistor input from the sample heater
- Flow and pressure sensor inputs
- Proportional valve output
- Optical pickup input
- Pre-amp board
- Ambient temperature/RTD and RH
- Flow RTDs

**Flow Sensor System** The flow sensor system consists of a subsonic orifice inside the primary measurement head, a differential pressure and vacuum sensors, and a flow temperature RTD. The flow system output is produced by measuring the pressure difference across a precision orifice. This unit is used for measuring the flow of sample gas in the measurement system.

**Pressure Sensor Assembly** The pressure sensor assembly consists of a board containing three pressure transducers with tube connections. The pressure transducer output is produced by measuring the pressure difference between the sample gas pressure and ambient air pressure.

**Detector Amplifier Assembly** The detector amplifier assembly amplifies the signal from the proportional detector that receives beta particle emissions from the C-14 source through the sample and filter tape. The output of the detector amplifier is fed to the measurement interface board. A coaxial cable from the detector amplifier supplies power and grounding to the detector.

## Digital Output Board

The digital output board connects to the motherboard and provides solenoid driver outputs and relay contact outputs to a connector located on the rear panel of the instrument. Ten relay contacts, normally open (with power off), are provided, which are electrically isolated from each other. Eight solenoid driver outputs (open collector) are provided along with a corresponding +24 VDC supply pin on the connector.

## I/O Expansion Board (Optional)

The I/O expansion board connects to the motherboard and adds the capability to input external analog voltage signals and to output analog currents via a connector located on the rear panel of the instrument. It contains local power supplies, a DC/DC isolator supply, a sub-processor and analog circuits. Eight analog voltage inputs are provided with an input voltage range of 0V to 10 VDC. Six current outputs are provided with a normal operating range of 0 to 20 mA.

## Front Panel Connector Board

The front panel connector board interfaces between the motherboard and the function key panel and graphics display. It serves as a central location to tie the three connectors required for the function key panel, the graphics display control lines, and the graphics display backlight to a single ribbon cable extending back to the motherboard. This board also includes signal buffers for the graphics display control signals and a high voltage power supply for the graphics display backlight.

## I/O Components

External I/O is driven from a generic bus that is capable of controlling the following devices:

- Analog output (voltage and current)
- Analog input (voltage)
- Digital output (TTL levels)
- Digital input (TTL levels)

**Note** The instrument has spare solenoid valve drivers and I/O support for future expansion. ▲

## Analog Voltage Outputs

The instrument provides six analog voltage outputs. Each may be firmware configured for any one of the following ranges, while maintaining a minimum resolution of 12 bits:

- 0-100 mV
- 0-1 V
- 0-5 V
- 0-10 V

The user can calibrate each analog output zero and span point through the firmware. At least 5% of full-scale over and under range are also supported, but may be overridden in the firmware, if required.

The analog outputs may be assigned to any measurement or diagnostic channel with a user-defined range in the units of the selected parameter. The voltage outputs are independent of the current outputs.

### **Analog Current Outputs (Optional)**

The optional I/O expansion board includes six isolated current outputs. These are firmware configured for any one of the following ranges, while maintaining a minimum resolution of 11 bits:

- 0-20 mA
- 4-20 mA

The user can calibrate each analog output zero and span point through the firmware. At least 5% of full-scale over and under range are also supported, but may be overridden in the firmware, if required.

The analog outputs may be assigned to any measurement or diagnostic channel with a user-defined range in the units of the selected parameter. The current outputs are independent of the voltage outputs. The current outputs are isolated from the instrument power and ground, but they share a common return line (Isolated GND).

### **Analog Voltage Inputs (Optional)**

The optional I/O expansion board includes eight analog voltage inputs. These inputs are used to gather measurement data from third-party devices such as meteorological equipment. The user may assign a label, unit, and a conversion table (2 to 10 points). Each point in the conversion table consists of an analog input voltage value (0-10.5 V) and a corresponding user-defined reading value. Only two points are necessary for linear inputs, however, a larger number of points may be used to approximate non-linear inputs. All voltage inputs have a resolution of 12 bits over the range of 0 to 10 volts.

### **Digital Relay Outputs**

The instrument includes one power fail relay on the motherboard and ten digital output relays on the digital output board. These are reed relays rated for at least 500 mA @ 200 VDC.

The power fail relay is Form C (both normally opened and normally closed contacts). All other relays are Form A (normally opened contacts) and are used to provide alarm status and mode information from the analyzer, as well as remote control to other devices, such as for controlling valves during calibration. The user may select what information is sent out from each relay and whether the active state is opened or closed.

## **Digital Inputs**

Sixteen digital inputs are available, which may be programmed to signal instrument modes and special conditions including:

- Filter tape change
- Turn pump off
- Turn pump on
- Analog outputs to zero
- Analog outputs to full-scale

The actual use of these inputs will vary based on analyzer configuration.

The digital inputs are TTL level compatible and are pulled up within the analyzer. The active state can be user defined in firmware.

## **Serial Ports**

Two serial ports allow daisy chaining so that multiple analyzers may be linked using one PC serial port.

The standard bi-directional serial interface can be configured for either RS-232 or RS-485. The serial baud rate is user selectable in the firmware for standard speeds from 1200 to 115200 baud. The user can also set the data bits, parity, and stop bits. The following protocols are supported:

- C-Link
- MODBUS Slave
- Gesytec (Bayern-Hessen)
- Streaming Data
- ESM

The Streaming Data protocol transmits user-selected measurement data via the serial port in real-time for capture by a serial printer, datalogger, or PC.

## RS-232 Connection

A null modem (crossed) cable is required when connecting the analyzer to an IBM-compatible PC. However, a straight cable (one to one) may be required when connecting the analyzer to other remote devices. As a general rule, when the connector of the host remote device is female, a straight cable is required and when the connector is male, a null modem cable is required.

Data Format:

1200, 2400, 4800, 9600, 19200, 38400, 57600, or 115200 BAUD

7 or 8 data bits

1 or 2 stop bits

No, odd, or even parity

All responses are terminated with a carriage return (hex 0D)

Refer to [Table 8–1](#) for the DB9 connector pin configuration.

**Table 8–1.** RS-232 DB9 Connector Pin Configuration

DB9 Pin	Function
2	RX
3	TX
7	RTS
8	CTS
5	Ground

## RS-485 Connection

The instrument uses a four wire RS-485 configuration with automatic flow control (SD). Refer to [Table 8–2](#) for the DB9 connector pin configuration.

**Table 8–2.** RS-485 DB9 Connector Pin Configuration

DB9 Pin	Function
2	+ receive
8	- receive
7	+ transmit
3	- transmit
5	ground

## **Ethernet Connection**

An RJ45 connector is used for the 10Mbps Ethernet connection supporting TCP/IP communications via standard IPV4 addressing. The IP address may be configured for static addressing or dynamic addressing (set using a DHCP server).

Any serial port protocols may be accessed over Ethernet in addition to the serial port. Up to three simultaneous connections are allowed per protocol.

## **External Accessory Connector**

The external accessory connector is not used in the Model 5014*i* analyzer.

This port is used in other models to communicate with smart external devices that may be mounted hundreds of feet from the analyzer using an RS-485 electrical interface.





## Chapter 9

# Optional Equipment

The Model 5014*i* is available with the following options:

- “Inlet Assemblies” on page 9-1
- “Sampling Tube Extensions” on page 9-1
- “I/O Expansion Board Assembly” on page 9-1
- “25 Pin Terminal Board Assembly” on page 9-1
- “Terminal Block and Cable Kits” on page 9-2
- “Cables” on page 9-2
- “Mounting Options” on page 9-3
- “Roof Flange Assembly” on page 9-8

### Inlet Assemblies

The Model 5014*i* can be used for different applications. Using different inlet configurations (PM<sub>10</sub>, PM<sub>2.5</sub>, PM<sub>1</sub> Inlets), several particle size fractions can be monitored. The main application is the measurement of PM<sub>10</sub> and PM<sub>2.5</sub> for ambient air quality monitoring and health effect studies.

### Sampling Tube Extensions

Often the most compatible way to install the Model 5014*i* at air quality monitoring sites is to collocate the inlet at the same height as other similar-use inlets. The “[Installation](#)” chapter discusses specific siting criteria. In addition to using the optional inlets, extending the sample downtube length is necessary using a rigid sample tube.

### I/O Expansion Board Assembly

The I/O expansion board provides six analog current output channels (0-20 mA or 4-20 mA) and eight analog voltage inputs (0-10 V). The DB25 connector on the rear panel provides the interface for these inputs and outputs.

### 25 Pin Terminal Board Assembly

The 25-pin terminal board assembly is included with the optional I/O expansion board. Refer to “[Terminal Board PCB Assemblies](#)” in the “[Installation](#)” chapter for information on attaching the cable to the

connector board. For associated part numbers, refer to the “[Servicing](#)” chapter.

## Terminal Block and Cable Kits

The optional terminal block and cable kits provide a convenient way to connect devices to the instrument. These kits break out the signals on the rear panel connector to individual numbered terminals.

Two types of terminal block and cable kits are available. One kit is for the DB37 connectors and can be used for either the analog output connector or the relay output connector. The other kit is for the DB25 connector and can be used for the optional I/O expansion board. For associated part numbers, refer to “[External Device Connection Components](#)” on page 7-7.

Each kit consists of:

- one six-foot cable
- one terminal block
- one snap track

**Note** Supporting all of the connections on units with the optional I/O expansion board requires:

- two DB37 kits
- one DB25 kit

## Cables

[Table 9–1](#) identifies the optional individual cables that are available for the instrument and [Table 9–2](#) provides the cable color codes. For associated part numbers, refer to “[External Device Connection Components](#)” on page 7-7.

**Note** [Table 9–2](#) provides the color coding for both 25-pin cables and 37-pin cables. Color codes for pins 1–25 are for 25-pin cables; color codes for pins 1–37 are for 37-pin cables. ▲

**Table 9–1.** Cable Options

Description	Cable Length
DB37M to open end	Six feet
DB37F to open end	Six feet
DB25M to open end	Six feet
RS-232	Six feet

**Table 9–2.** Color Codes for 25-Pin and 37-Pin Cables

Pin	Color	Pin	Color
1	BLACK	20	RED/BLACK
2	BROWN	21	ORANGE/BLACK
3	RED	22	YELLOW/BLACK
4	ORANGE	23	GREEN/BLACK
5	YELLOW	24	GRAY/BLACK
6	GREEN	25	PINK/BLACK
7	BLUE	End color codes for 25-pin cables continue for 37-pin cables.	
8	VIOLET	26	PINK/GREEN
9	GRAY	27	PINK/RED
19	WHITE	28	PINK/VIOLET
11	PINK	29	LIGHT BLUE
12	LIGHT GREEN	30	LIGHT BLUE/BROWN
13	BLACK/WHITE	31	LIGHT BLUE/RED
14	BROWN/WHITE	32	LIGHT BLUE/VIOLET
15	RED/WHITE	33	LIGHT BLUE/BLACK
16	ORANGE/WHITE	34	GRAY/GREEN
17	GREEN/WHITE	35	GRAY/RED
18	BLUE/WHITE	36	GRAY/VIOLET
19	VIOLET/WHITE	37	LIGHT GREEN/BLACK

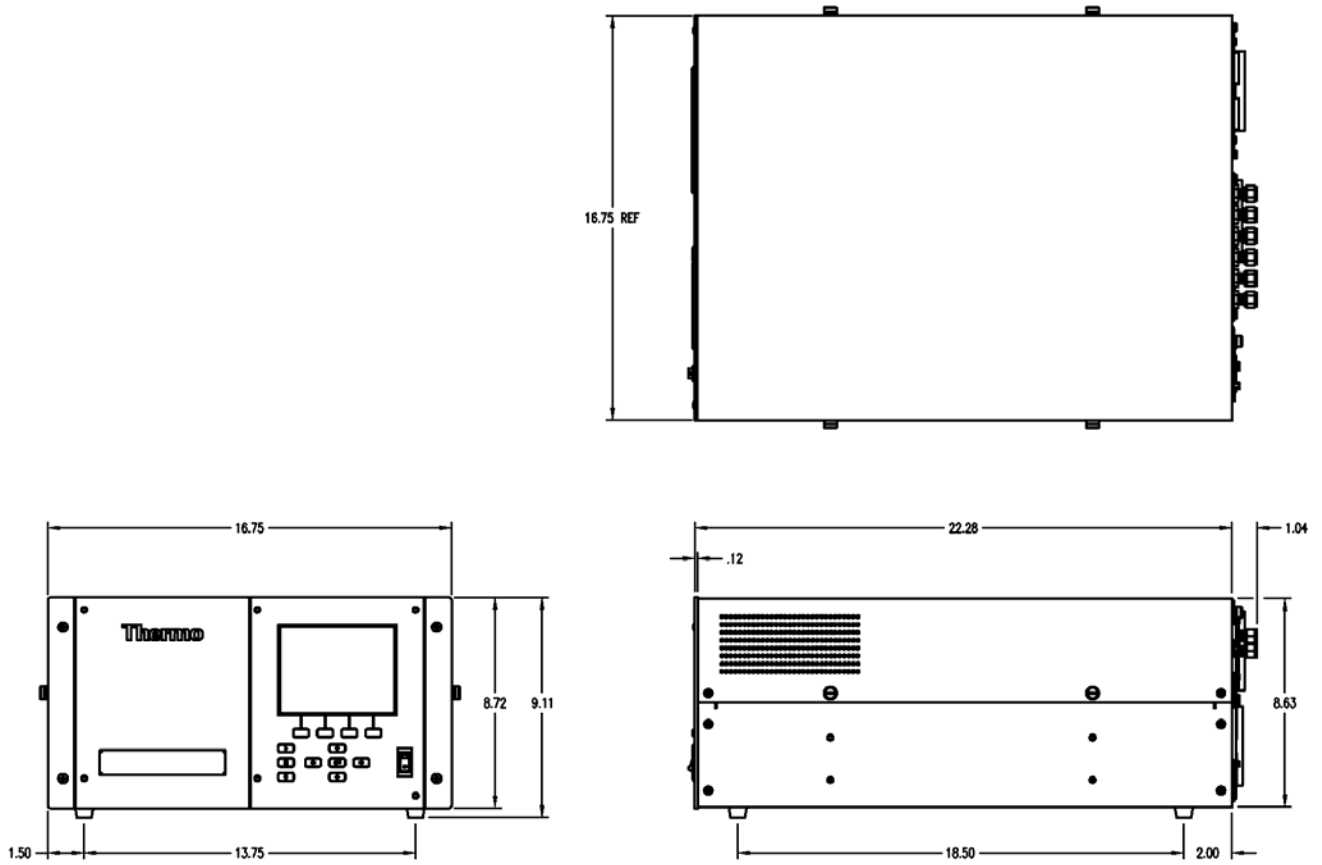
## Mounting Options

The analyzer can be installed in the configuration described in [Table 9–3](#) and shown in [Figure 9–1](#) through [Figure 9–4](#).

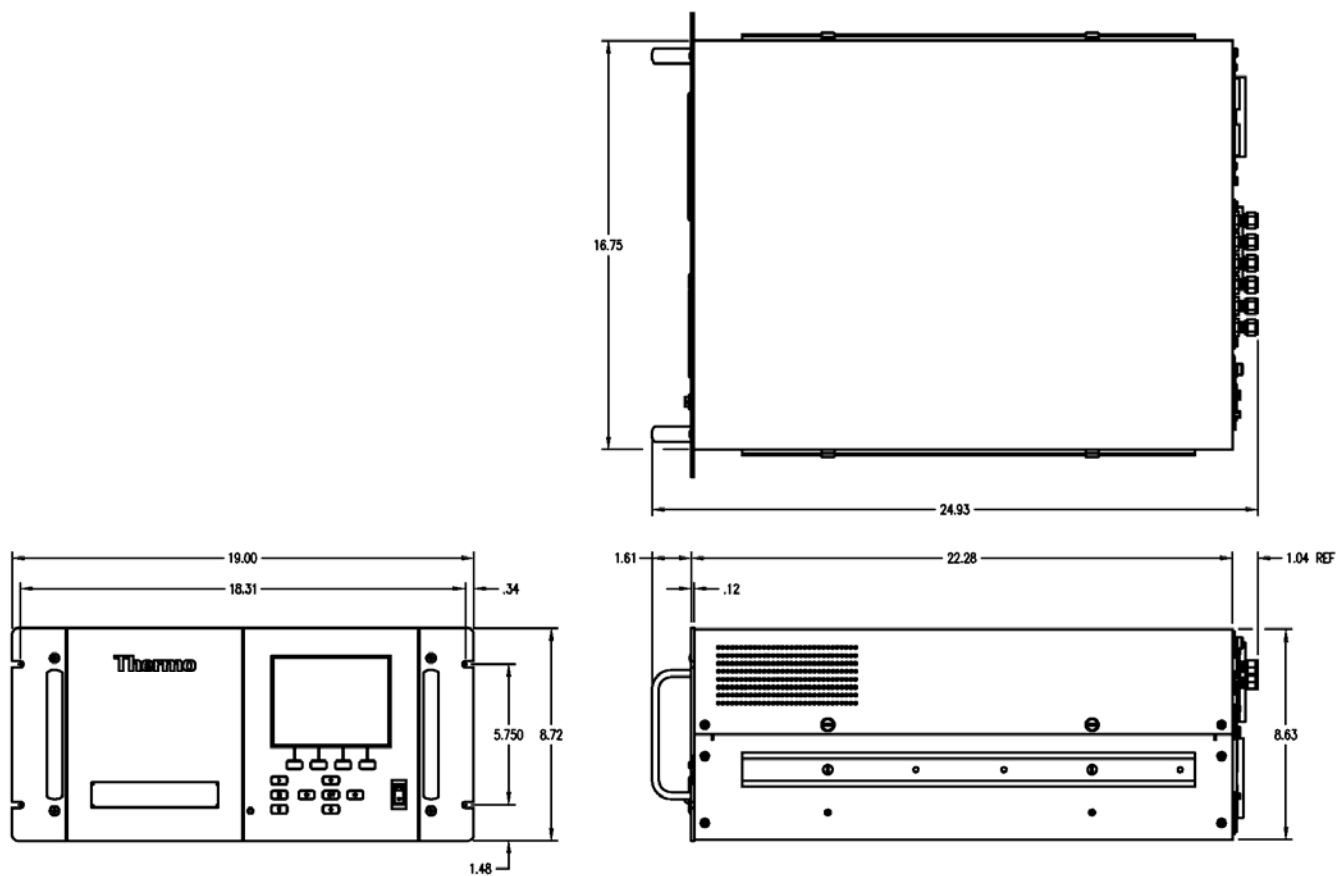
**Table 9–3.** Mounting Options

Mounting Type	Description
Bench	Positioned on bench, includes mounting feet and front panel side-trim handles.
EIA rack (top position)	Mounted in an EIA-style rack, includes mounting slides and front panel EIA-rack mounting handles.
Retrofit rack (top position)	Mounted in an EIA-style rack, includes mounting slides and front panel EIA-rack mounting handles. This configuration is intended for direct replacement of a C-series instrument in an existing rack. The rail mounting location is lower on the case and the front mounting screw slots have non-standard EIA locations.

**Optional Equipment**  
Mounting Options

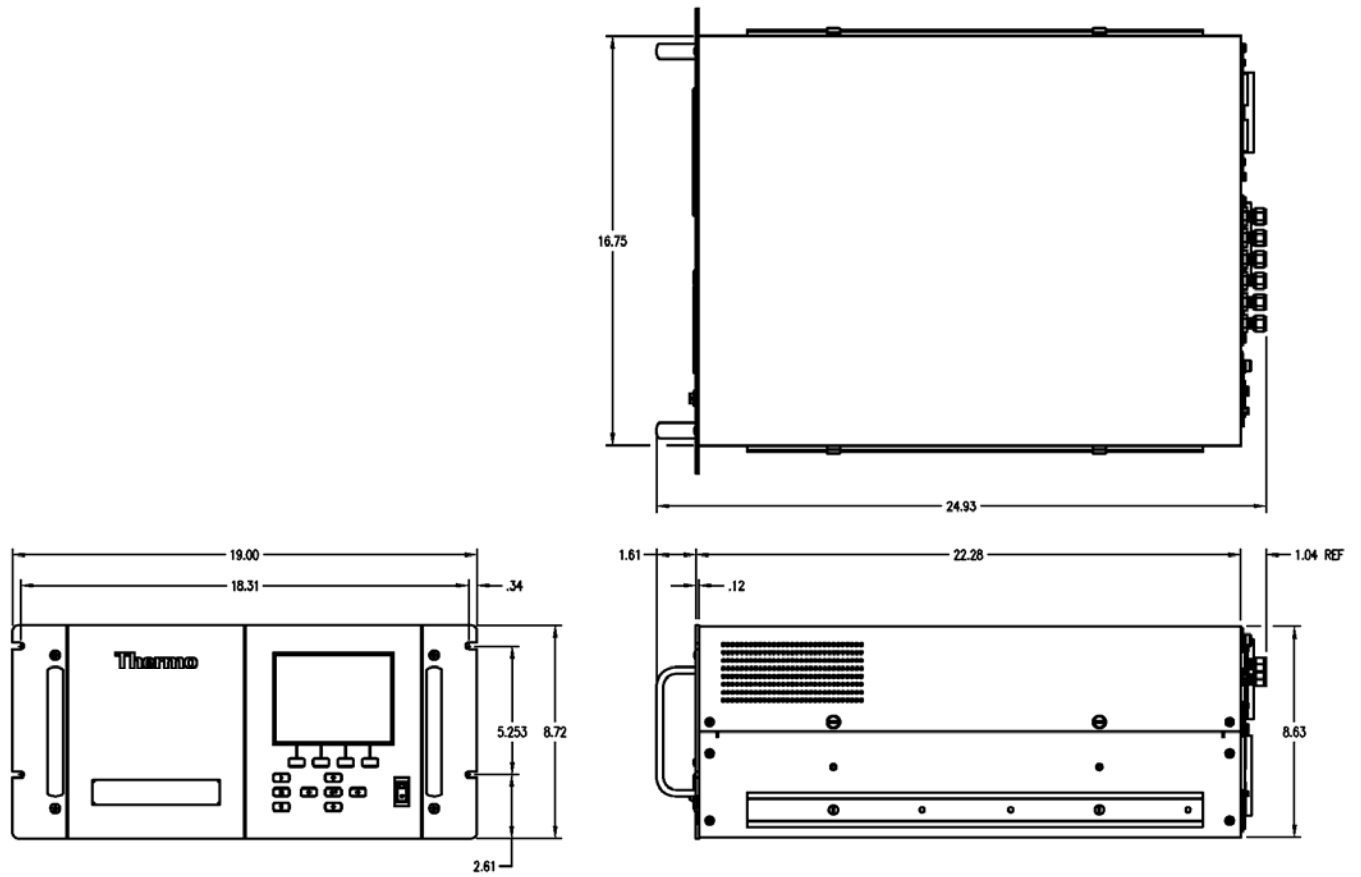


**Figure 9-1.** Bench Mounting



**Figure 9–2.** EIA Rack Mounting

**Optional Equipment**  
Mounting Options



**Figure 9-3.** Retrofit Rack Mounting

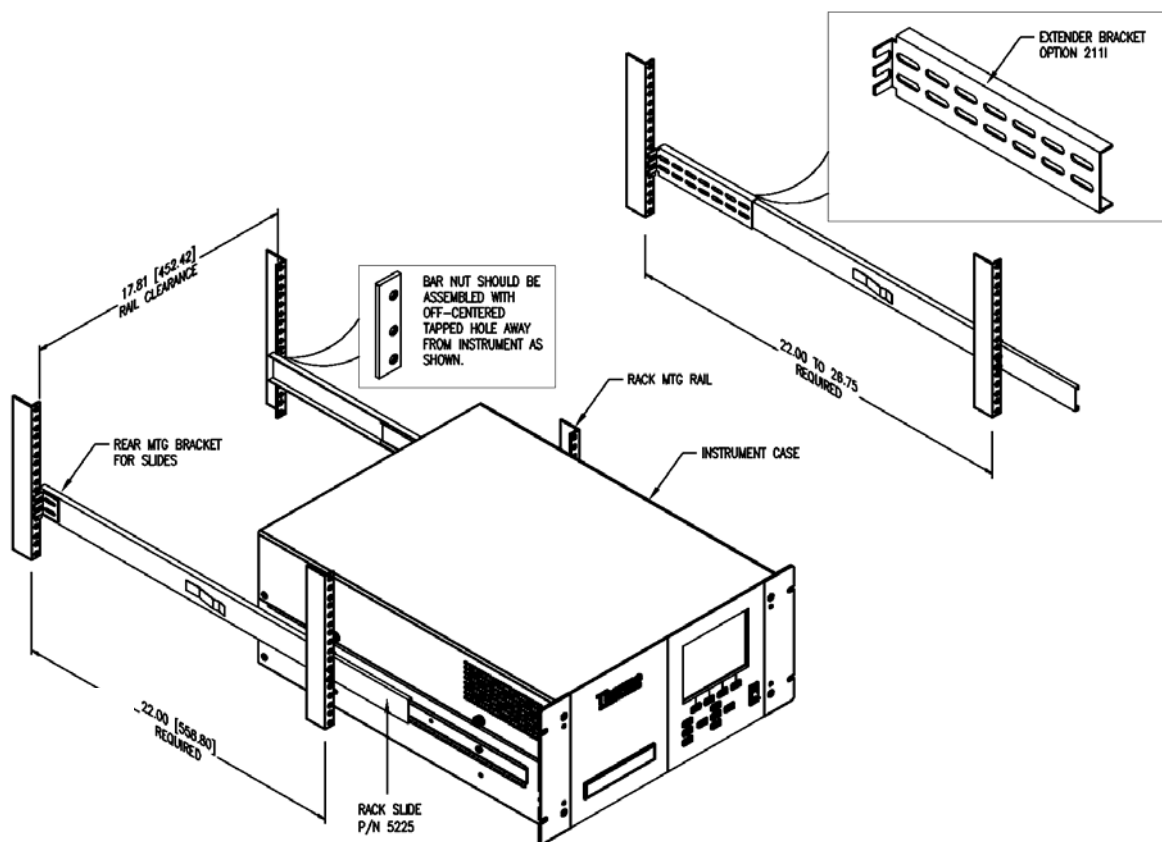


Figure 9-4. Rack Mount Option Assembly

## Roof Flange Assembly

An optional roof flange assembly can be used with flat roof applications, as shown in Figure 9-5. This roof flange assembly uses 3" PVC tubing, fittings and roof flange with gasketing. The installer must assure a water tight installation when using a flange of this design. A 2-1/2" circular hole should be drilled through the roofline of the enclosure, or building, if it has a flat roof. The roof surface should be clean and swept of all debris. The flange should be centered over the hole that has been drilled. A generous bead of RTV or silicone sealant should be applied to the circumference of the joints shown in Figure 9-5.

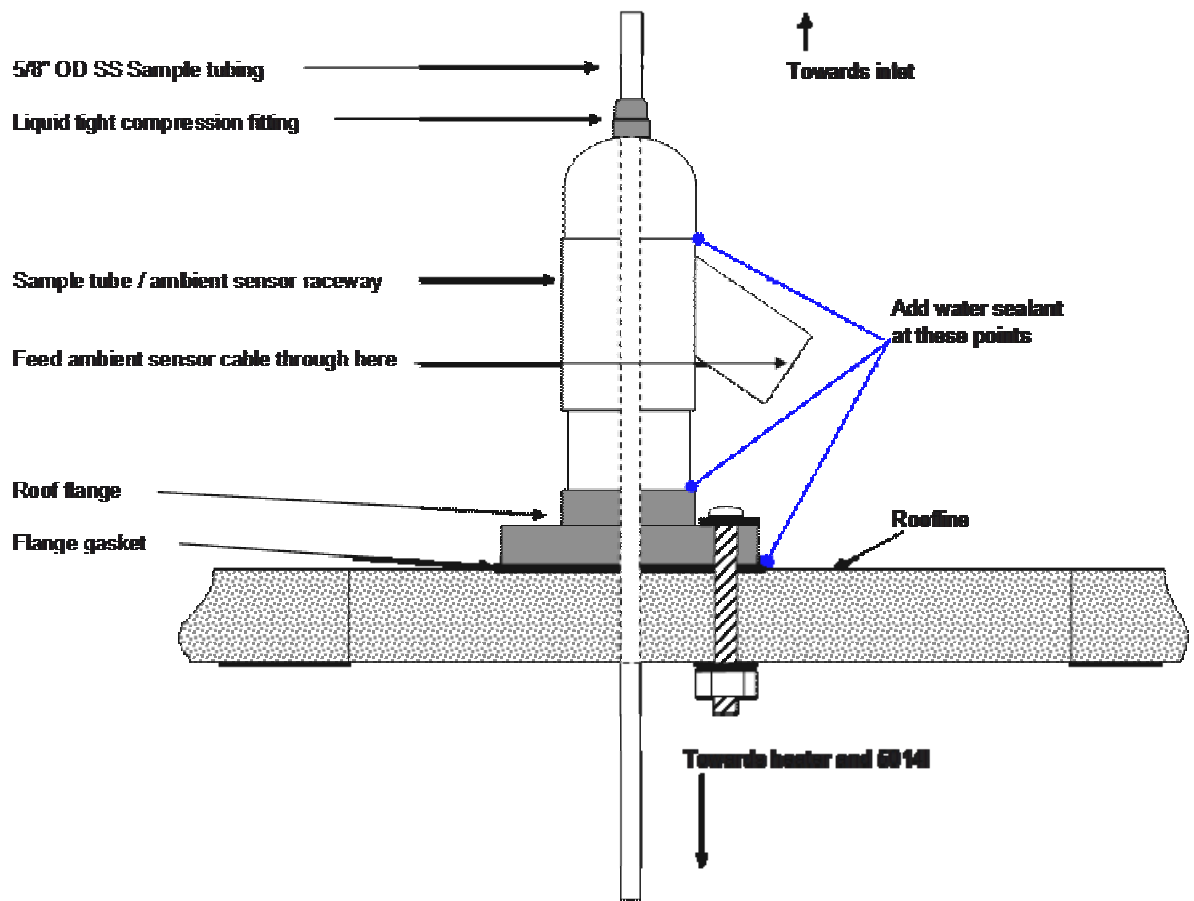
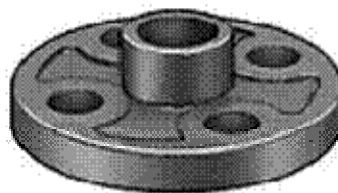


Figure 9-5. Roof Flange Assembly



The flange design also has four holes that can be used to secure the flange to the roof surface by the use of carriage bolts, washers and nuts. The length of the carriage bolts depends on the thickness of the roofline. [Figure 9-6](#) shows a picture of the roof flange that is used with this assembly.



**Figure 9-6.** Securing the Roof Flange



# Chapter 10

## Model 5014*i* to 5030*i* Upgrade Procedures

This chapter describes the 5014*i* to 5030*i* upgrade procedures. For details, see the following topics:

- “Instrument Preparation” on page 10-1
- “SHARP Connection Bracket Assembly Installation” on page 10-2
- “Radius Tube Adapter Installation” on page 10-5
- “SHARP External Valve Installation” on page 10-7
- “SHARP Optics Assembly Installation” on page 10-9
- “Upgrade of the Heater Tube Assembly” on page 10-10
- “Model Label Change” on page 10-11
- “Power On Instrument” on page 10-11

### Instrument Preparation

Use the following procedure to prepare the instrument.

1. If upgrading at an installed site, take the appropriate measures to secure the sample downtube and remove the instrument heater assembly and set aside.
2. From Instrument Panel, select Main Menu, select Instrument Controls and then Service Mode. Toggle to “Service Mode On”.
3. From Instrument Panel, select Filter Tape, and then Manual, and select the BENCH to open.
4. From Instrument Panel, select Diagnostics, Instrument Configuration, and change the DETECTOR configuration from BETA to SHARP.
5. Turn instrument power off with the measurement head in the open position.

6. Unplug instrument from AC power source.

```
INSTRUMENT CONFIGURATION:
>I/O EXPANSION BOARD YES
DETECTOR BETA
DETECTOR B NONE

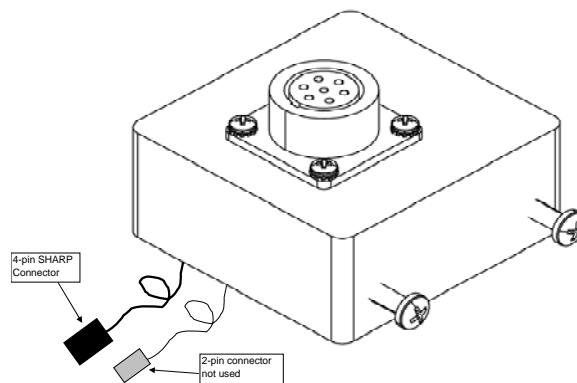
◀▶ CHANGE VALUE   ◀ SAVE

RANGE  AVG  DIAGS  ALARM
```

## SHARP Connection Bracket Assembly Installation

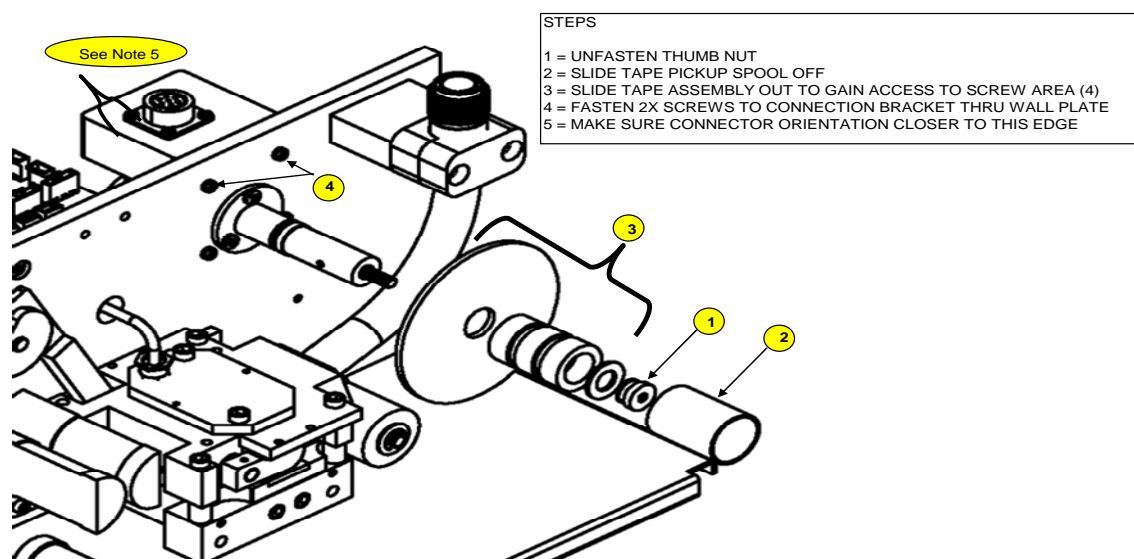
Use the following procedure for SHARP connection bracket assembly installation.

1. Locate the Connection Bracket (Figure 10–1) and remove two screws and set aside.



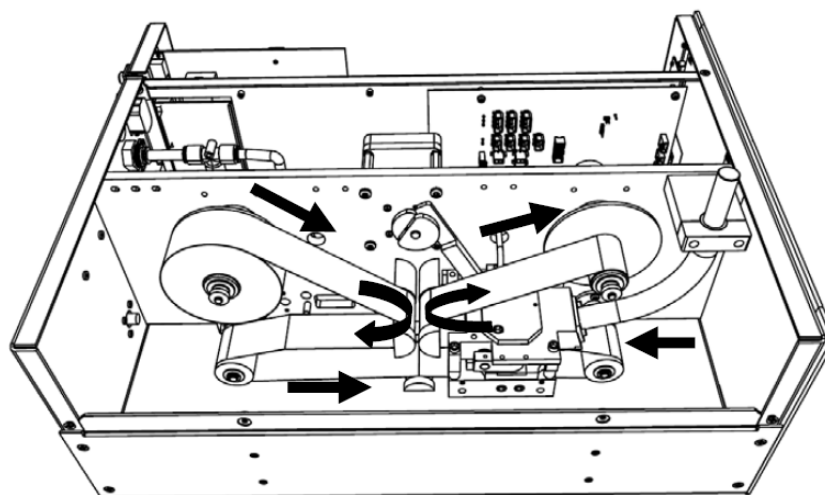
**Figure 10–1.** SHARP Optics Connection Bracket

2. Remove both sides of the Cover. Remove the tape pick up spool (Figure 10–2) by removing the thumb screw, washer, filter tape, spacers, o-rings and rear filter support guide plate.



**Figure 10–2.** Tape Pick-up Spool Removal

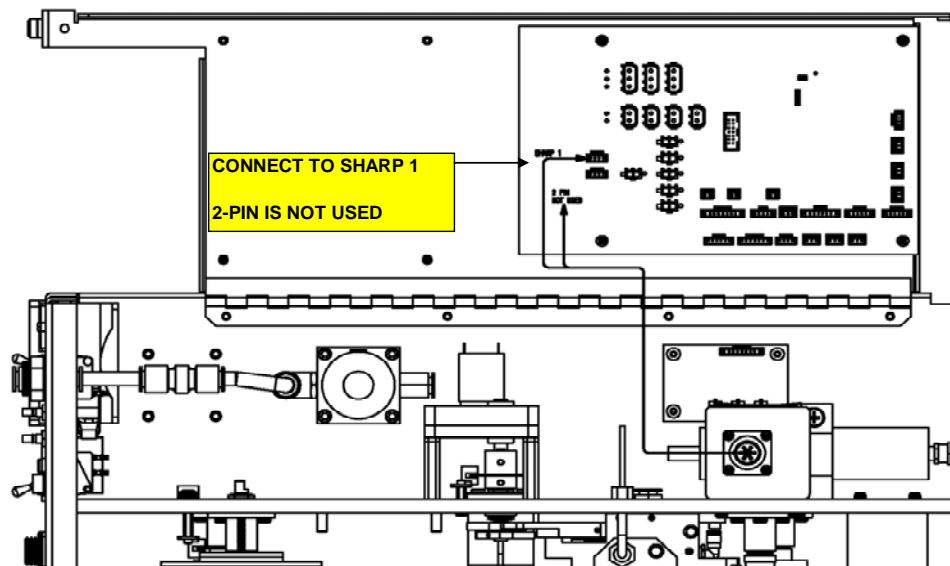
3. Remove the two Philips screws from the connection bracket and align the bracket onto the wall plate, as shown above in Step 4, and insert the two screws through the wall plate and tighten.
4. Reinstall the tape pickup spool in the reverse order of removal in Step 2 by sliding all the spacers, O-rings and rear support guide plate into its original assembly order.
5. Install the filter tape following the filter tape path shown in [Figure 10–3](#). Use adhesive tape to adhere the filter tape to the take up spool and wind the tape over itself at least once.



**Figure 10–3.** Filter Tape Installation Pathway

6. Complete the installation of the SHARP Optics Connection Bracket by connecting the 4-pin connector to the “SHARP 1” connector on the measurement interface board as shown below in [Figure 10–4](#).

**Note** It should not be necessary to remove the electronics from the instrument case to achieve this connection and the spare 2-pin connector is not used. ▲

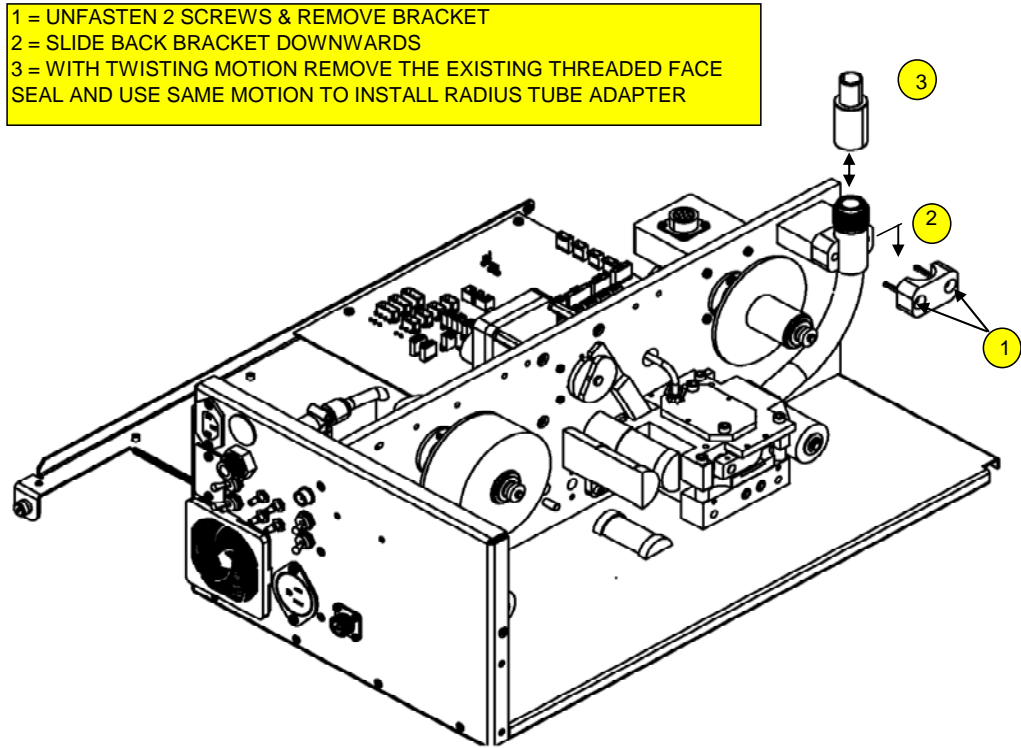


**Figure 10–4.** Connecting Connection Bracket Wiring to Measurement Interface Board

## Radius Tube Adapter Installation

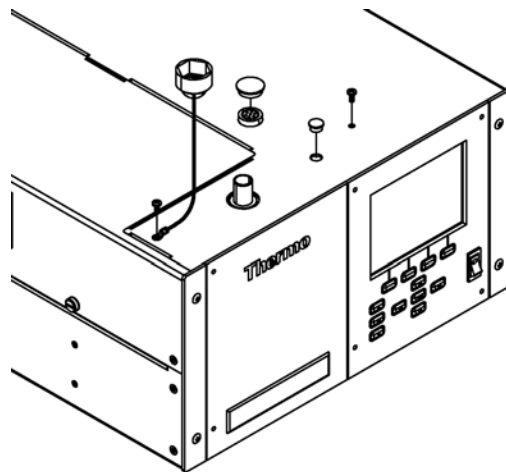
Use the following procedure for radius tube adapter installation.

1. Loosen the Radius Tube Mounting bracket screws.
2. Slide back bracket downwards.
3. Slowly remove the existing Radius Face Seal by pulling straight up with a twisting action.
4. Slowly insert the Radius Tube Adapter onto the Radius Tube and push down with a slight twist until it is seated.
5. Tighten the radius tube mounting bracket screws as shown in [Figure 10–5](#).



**Figure 10–5.** Radius Tube Adapter Install

6. Reassemble the two covers of the instrument in reverse order and check alignment of radius tube adapter through the hole in the cover as shown in **Figure 10–6**. Be sure to remove the old dust cover cap and the large plastic hole cover.



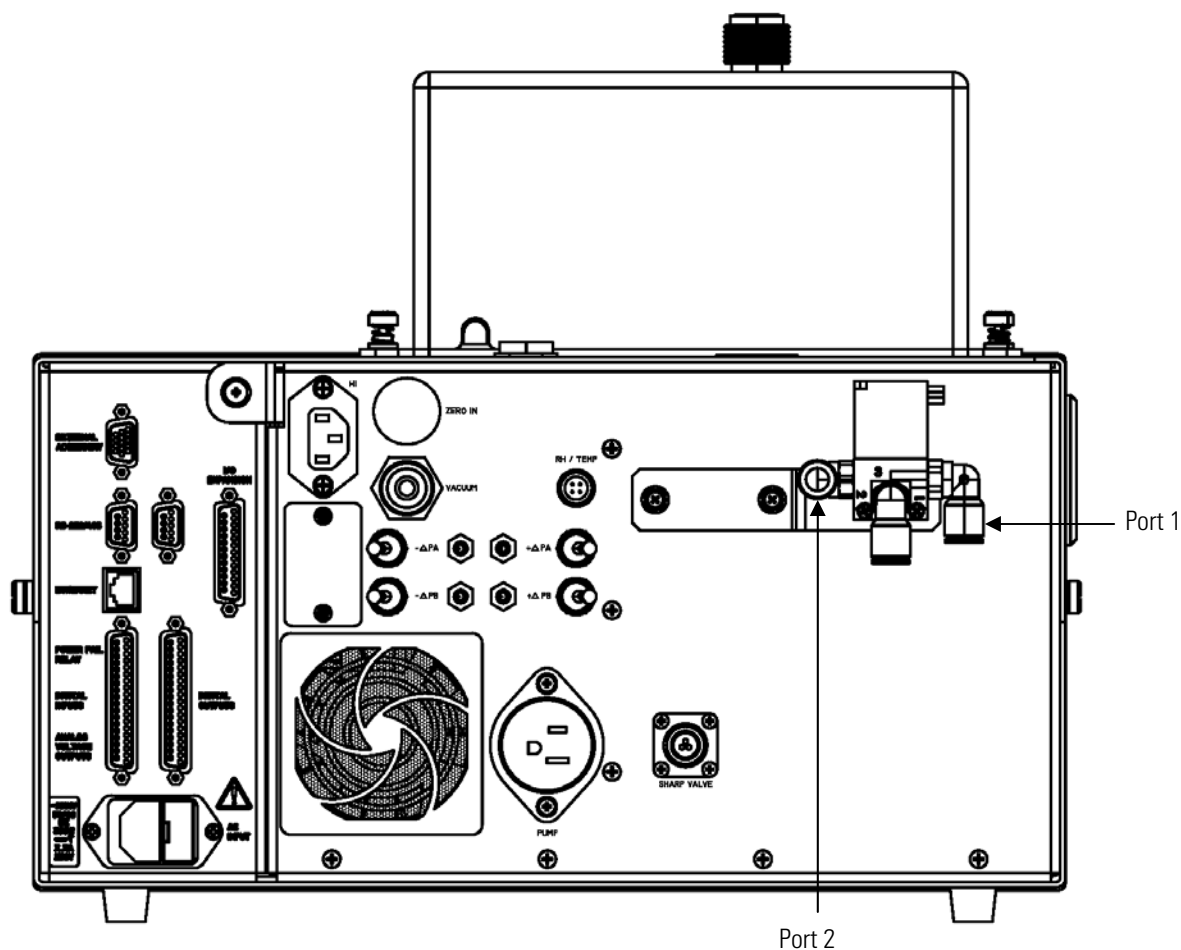
**Figure 10–6.** Radius Tube Adapter Alignment Check



## SHARP External Valve Installation

Use the following procedure for SHARP external valve installation.

1. Attach the SHARP External Valve Assembly (which includes the to the Rear Panel using the captive hardware on bracket and attach the 3-pin connector to the rear panel labeled valve (Figure 10–7).



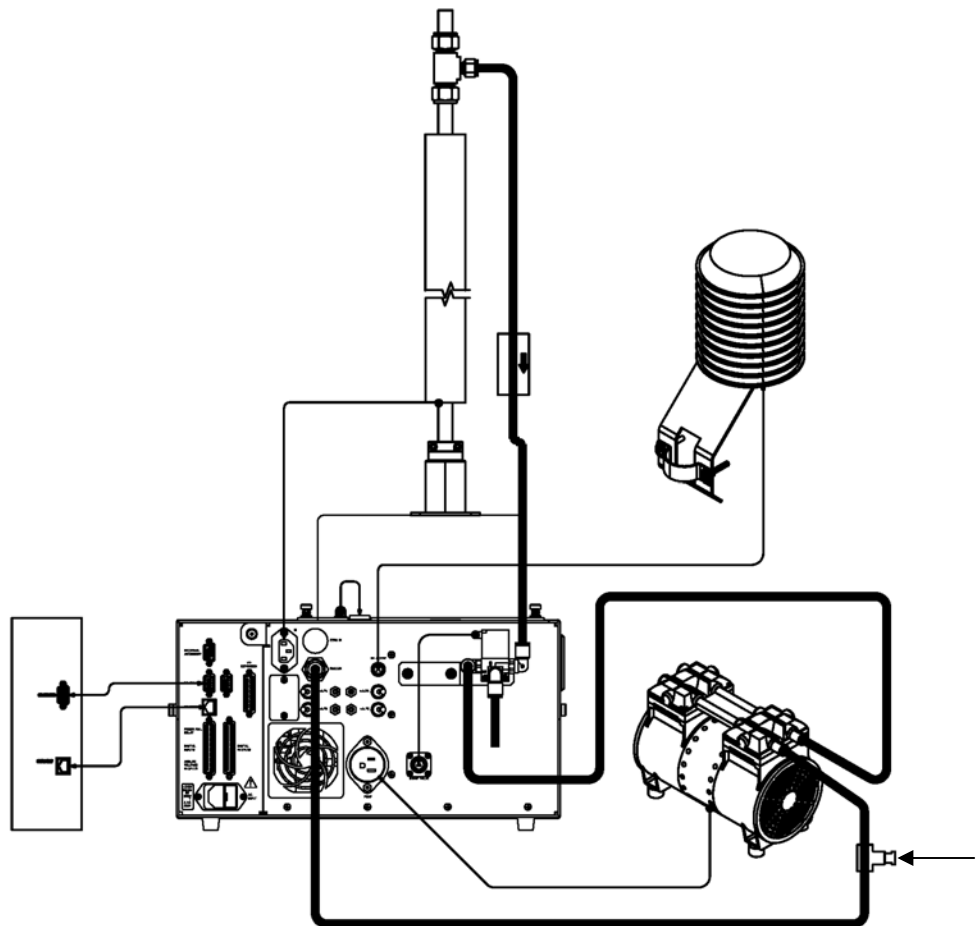
**Figure 10–7.** Rear Valve Assembly Installation

2. Follow the following plumbing procedure in accordance with Figure 10–8 below.
  - a. Attach the 3/8” vacuum tubing between pump intake and the vacuum port on rear panel and include the push-to-connect “T” fitting with the 0.040” thru-hole on the T-side in this line.
  - b. From the valve assembly that is now attached to the rear panel, connect the threaded fitting to the pump exhaust.

- c. Connect the 3/8" tubing with inline HEPA filter to the available port (Port #1) on the external valve assembly using the available push connect fitting.

**Note** This step can also be delayed until after the zero air delivery tube and T-fitting are installed at the sample intake. ▲

- d. At the sample inlet, attach the stainless steel T-fitting to the sample downtube and tighten the swagelok fitting with Teflon ferrules—do not overtighten these ferrules.
- e. Snake the green vacuum tubing downwards towards the rear valve assembly and attach to Port #1 of the valve. If this is a field installation, proper water sealants should be used to avoid any leakage into the instrument.

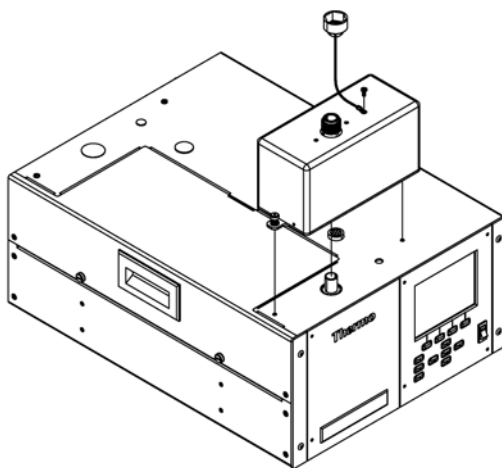


**Figure 10–8.** Plumbing Diagram

## SHARP Optics Assembly Installation

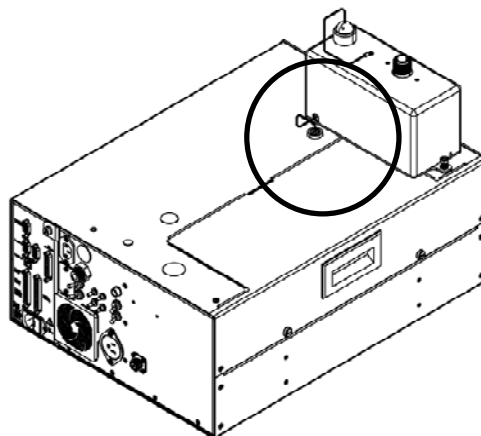
Use the following procedure for SHARP external valve installation.

1. Remove the SHARP Optics Assembly port protection caps and plugs.
2. Align the radius tube adapter with the open port on the bottom of the optics assembly as per [Figure 10–9](#) and gently push down and then screw down the two tabs using the captive hardware.



**Figure 10–9.** Optics Installation

3. Connect the cable assembly from the rear panel of the Optical assembly and secure it to the optics connector that was installed in Step 3 of this procedure and as shown in [Figure 10–10](#).



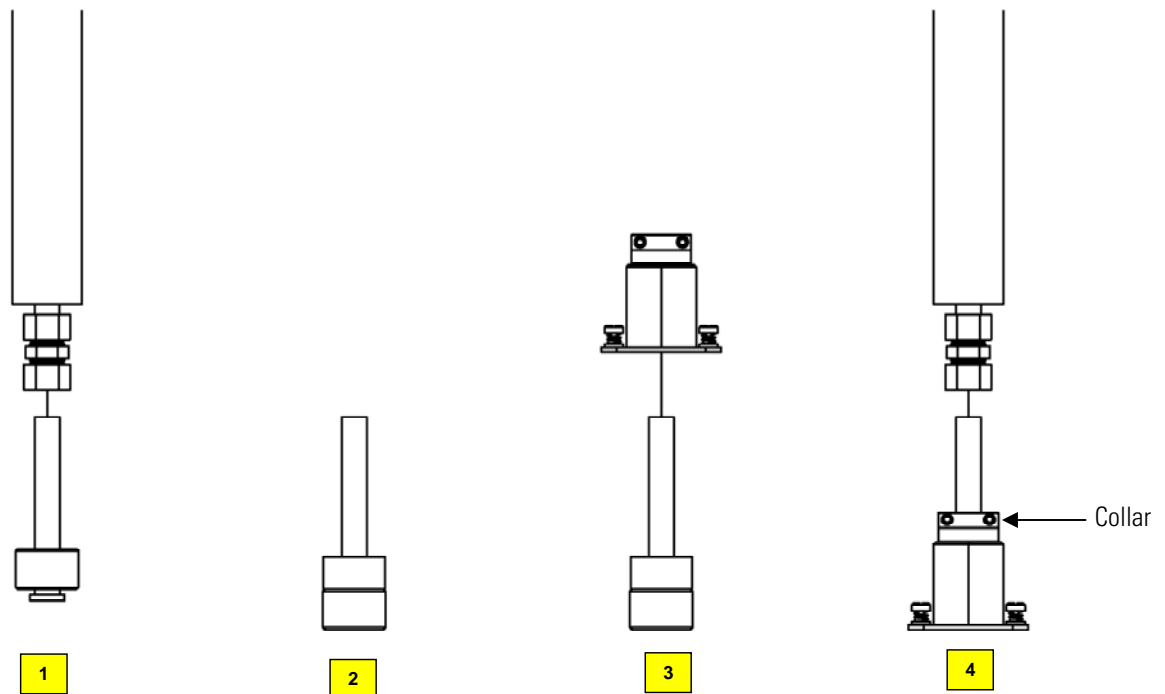
**Figure 10–10.** Connecting the Optics to the Optics Connector

## Upgrade of the Heater Tube Assembly

Use the following procedure for upgrade of the heater tube assembly.

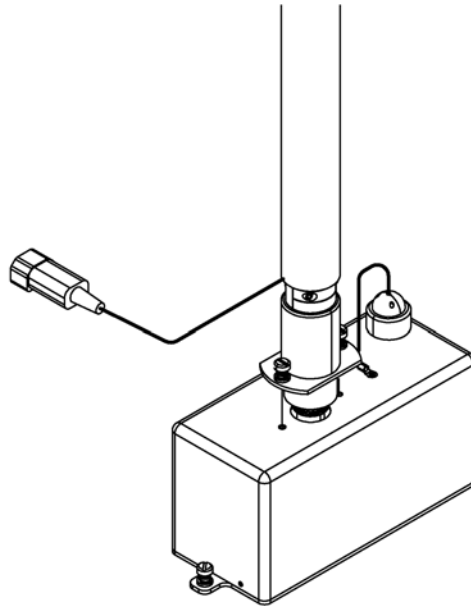
1. The heater assembly needs to be revised for the 5030i SHARP to include a ferrite bead and a small faraday cage. The four steps shown below in Figure 10–11 and Figure 10–12 should be used to modify the heater assembly.

**Note** The sample downtube should be slightly loose at the roof line to allow vertical play while working on this assembly. If the tubing height has changed and needs to be cut back, please cut and clean the tubing before attaching to the optical assembly. ▲



- 1) Remove existing stainless knurled nut from heater assembly
- 2) Install black plastic knurled nut on top of optical assembly and tighten firmly; and slide ferrite bead around short stainless tube.
- 3) Slide black housing over both ferrite bead and black plastic nut and attach the two captive screws to the top of the optical assembly.
- 4) Tighten both hex screws to close collar.
- 5) Connect the heater tube assembly to the top of the stainless tube and tighten the Teflon ferrule swage fitting..

Figure 10–11. Upgrading 5030i Heater Assembly

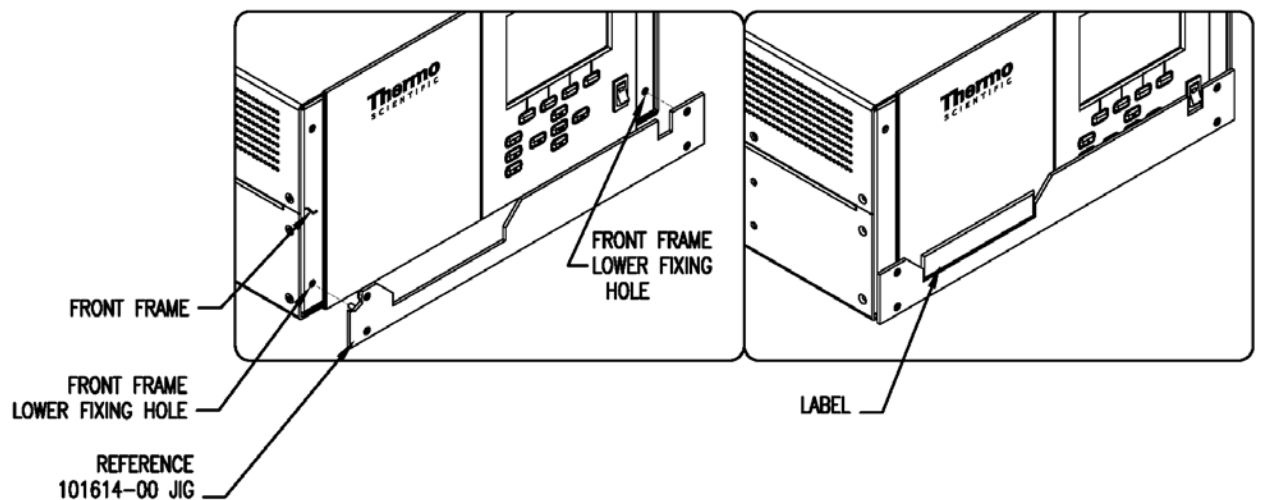


**Figure 10–12.** Connecting Heater to Optics Assembly Cover

## Model Label Change

Use the following procedure for model label change.

1. Remove the 5014*i* label and replace with the new 5030*i* SHARP Label on the front panel Front Panel in accordance with [Figure 10–13](#) below.



**Figure 10–13.** Front Panel Label Replacement

## Power On Instrument

Upgrade is complete.



# Appendix A

## Warranty

Seller warrants that the Products will operate or perform substantially in conformance with Seller's published specifications and be free from defects in material and workmanship, when subjected to normal, proper and intended usage by properly trained personnel, for the period of time set forth in the product documentation, published specifications or package inserts. If a period of time is not specified in Seller's product documentation, published specifications or package inserts, the warranty period shall be one (1) year from the date of shipment to Buyer for equipment and ninety (90) days for all other products (the "Warranty Period"). Seller agrees during the Warranty Period, to repair or replace, at Seller's option, defective Products so as to cause the same to operate in substantial conformance with said published specifications; provided that (a) Buyer shall promptly notify Seller in writing upon the discovery of any defect, which notice shall include the product model and serial number (if applicable) and details of the warranty claim; (b) after Seller's review, Seller will provide Buyer with service data and/or a Return Material Authorization ("RMA"), which may include biohazard decontamination procedures and other product-specific handling instructions; and (c) then, if applicable, Buyer may return the defective Products to Seller with all costs prepaid by Buyer. Replacement parts may be new or refurbished, at the election of Seller. All replaced parts shall become the property of Seller. Shipment to Buyer of repaired or replacement Products shall be made in accordance with the Delivery provisions of the Seller's Terms and Conditions of Sale. Consumables, including but not limited to lamps, fuses, batteries, bulbs and other such expendable items, are expressly excluded from the warranty under this warranty.

Notwithstanding the foregoing, Products supplied by Seller that are obtained by Seller from an original manufacturer or third party supplier are not warranted by Seller, but Seller agrees to assign to Buyer any warranty rights in such Product that Seller may have from the original manufacturer or third party supplier, to the extent such assignment is allowed by such original manufacturer or third party supplier.

In no event shall Seller have any obligation to make repairs, replacements or corrections required, in whole or in part, as the result of (i) normal wear and tear, (ii) accident, disaster or event of force majeure, (iii) misuse, fault or negligence of or by Buyer, (iv) use of the Products in a manner for which

they were not designed, (v) causes external to the Products such as, but not limited to, power failure or electrical power surges, (vi) improper storage and handling of the Products or (vii) use of the Products in combination with equipment or software not supplied by Seller. If Seller determines that Products for which Buyer has requested warranty services are not covered by the warranty hereunder, Buyer shall pay or reimburse Seller for all costs of investigating and responding to such request at Seller's then prevailing time and materials rates. If Seller provides repair services or replacement parts that are not covered by the warranty provided in this warranty, Buyer shall pay Seller therefor at Seller's then prevailing time and materials rates. ANY INSTALLATION, MAINTENANCE, REPAIR, SERVICE, RELOCATION OR ALTERATION TO OR OF, OR OTHER TAMPERING WITH, THE PRODUCTS PERFORMED BY ANY PERSON OR ENTITY OTHER THAN SELLER WITHOUT SELLER'S PRIOR WRITTEN APPROVAL, OR ANY USE OF REPLACEMENT PARTS NOT SUPPLIED BY SELLER, SHALL IMMEDIATELY VOID AND CANCEL ALL WARRANTIES WITH RESPECT TO THE AFFECTED PRODUCTS.

THE OBLIGATIONS CREATED BY THIS WARRANTY STATEMENT TO REPAIR OR REPLACE A DEFECTIVE PRODUCT SHALL BE THE SOLE REMEDY OF BUYER IN THE EVENT OF A DEFECTIVE PRODUCT. EXCEPT AS EXPRESSLY PROVIDED IN THIS WARRANTY STATEMENT, SELLER DISCLAIMS ALL OTHER WARRANTIES, WHETHER EXPRESS OR IMPLIED, ORAL OR WRITTEN, WITH RESPECT TO THE PRODUCTS, INCLUDING WITHOUT LIMITATION ALL IMPLIED WARRANTIES OF MERCHANTABILITY OR FITNESS FOR ANY PARTICULAR PURPOSE. SELLER DOES NOT WARRANT THAT THE PRODUCTS ARE ERROR-FREE OR WILL ACCOMPLISH ANY PARTICULAR RESULT.



# Appendix B

## C-Link Protocol Commands

This appendix provides a description of the C-Link protocol commands that can be used to remotely control a Model 5014*i* analyzer using a host device such as a PC or a datalogger. C-Link protocol may be used over RS-232, RS-485, or Ethernet. C-Link functions can be accessed over Ethernet using TCP port 9880.

Streaming data is sent out the serial port or the Ethernet port on a user-defined periodic basis. Streaming data over Ethernet is only generated when a connection is made on TCP port 9881.

Up to three simultaneous connections per protocol may be made over Ethernet.

For details, see the following topics:

- “[Instrument Identification Number](#)” on page B-1
- “[Commands](#)” on page B-2
- “[Measurements](#)” on page B-9
- “[Alarms](#)” on page B-11
- “[Diagnostics](#)” on page B-17
- “[Datalogging](#)” on page B-20
- “[Calibration](#)” on page B-27
- “[Keys/Display](#)” on page B-34
- “[Measurement Configuration](#)” on page B-35
- “[Hardware Configuration](#)” on page B-41
- “[Communications Configuration](#)” on page B-43
- “[I/O Configuration](#)” on page B-50
- “[Record Layout Definition](#)” on page B-55

### Instrument Identification Number

Each command sent to the analyzer over the serial port must begin with the American Standard Code for Information Interchange (ASCII) symbol or byte value equivalent to the instrument’s identification number plus 128.

For example, if the instrument ID is set to 14, then each command must begin with the ASCII character code 142 decimal. The analyzer ignores any command that does not begin with its instrument identification number. If the instrument ID is set to 0, then this byte is not required. For more information on changing Instrument ID, see Chapter 3, “[Operation](#)”.

## Commands

The analyzer must be in the remote mode and service mode not active in order to change instrument parameters remotely. However, the command “set mode remote” can be sent to the analyzer to put it in the remote mode. Report commands (commands that don’t begin with “set”) can be issued either in the remote or local mode, regardless of the service mode setting. For information on changing modes, see Chapter 3, “[Operation](#)”.

The commands are not case sensitive. Each command must begin with the proper instrument identification number (ASCII) character. The command in the following example begins with the ASCII character code 142 decimal, which directs the command to the Model 5014*i*, and is terminated by a carriage return “CR” (ASCII character code 13 decimal).

<ASCII 142>	T	I	M	E	<CR>
-------------	---	---	---	---	------

Many of the commands have two forms. One form reads parameter from the instrument’s memory, and the other writes, or updates, a parameter. The syntax for a write command adds the word “set” in front of the command and provides an argument. Command responses are generally echoed with a data element appended.

**Note** If the Service Mode is active, C-Link “set” commands are not allowed. This is to prevent parameters from being changed remotely while the unit is being serviced locally. ▲

If an incorrect command is sent, an error message is generated. The list of error responses is shown in [Table B–1](#). The following example sends the incorrect command “set unit mg/m3” instead of the correct command “set conc unit mg/m3.”

```
Send:          set unit mg/m3
Receive:       set unit mg/m3 bad cmd
```

**Table B–1.** Error Response Messages

Command Response	Description
bad cmd	Command is not recognized
too high	Supplied value is higher than the upper limit
too low	Supplied value is lower than the lower limit
invalid string	Supplied string invalid (typically because a letter was detected when the value should be numeric)
data not valid	Supplied value is not acceptable for entered command
can't, wrong settings	Command not allowed for current measurement mode
can't, mode is service	Command not allowed while instrument is in service mode
feature not enabled	I/O expansion board is not detected
flags no alarm active	No measurement alarms are active

The “save” and “set save params” commands (duplicated for backward compatibility) store parameters in FLASH memory. It is important that this command be sent each time instrument parameters are changed. If changes are not saved, they will be lost in the event of a power failure.

## Commands List

Table B–2 lists the 5014*i* C-Link protocol commands. The interface will respond to the command strings outlined below.

**Table B–2.** C-Link Protocol Commands

Command	Description	Page
1	Simulates pressing soft key 1 pushbutton	B-34
2	Simulates pressing soft key 2 pushbutton	B-34
3	Simulates pressing soft key 3 pushbutton	B-34
4	Simulates pressing soft key 4 pushbutton	B-34
addr dns	Reports/sets domain name server address for Ethernet port	B-43
addr gw	Reports/sets default gateway address for Ethernet port	B-44
addr ip	Reports/sets IP address for Ethernet port	B-44
addr nm	Reports/sets netmask address for Ethernet port	B-44
addr ntp	Reports/sets IP address for network time protocol server	B-45
alarm alpha count max	Reports/sets alpha count alarm maximum value	B-11
alarm alpha count min	Reports/sets alpha count alarm minimum value	B-11

## C-Link Protocol Commands

### Commands

<b>Command</b>	<b>Description</b>	<b>Page</b>
alarm amb rh max	Reports/sets ambient relative humidity alarm maximum value	B-11
alarm amb rh min	Reports/sets ambient relative humidity alarm minimum value	B-11
alarm amb temp max	Reports/sets ambient temperature alarm maximum value	B-12
alarm amb temp min	Reports/sets ambient temperature alarm minimum value	B-12
alarm baro pres max	Reports/sets barometric pressure alarm maximum value	B-12
alarm baro pres min	Reports/sets barometric pressure alarm minimum value	B-12
alarm bench status	Reports the bench status	B-12
alarm beta count max	Reports/sets beta count alarm maximum value	B-13
alarm beta count min	Reports/sets beta count alarm minimum value	B-13
alarm board temp max	Reports/sets board temperature alarm maximum value	B-13
alarm board temp min	Reports/sets board temperature alarm minimum value	B-13
alarm conc avg pm max	Reports/sets average PM concentration alarm maximum value	B-13
alarm conc avg pm min	Reports/sets average PM concentration alarm minimum value	B-13
alarm conc inst pm max	Reports/sets instant PM concentration alarm maximum value	B-14
alarm conc inst pm min	Reports/sets instant PM concentration alarm minimum value	B-14
alarm filter tape status	Reports the filter tape status	B-14
alarm flow max	Reports/sets flow alarm maximum value	B-14
alarm flow min	Reports/sets flow alarm minimum value	B-14
alarm flow pres max	Reports/sets flow pressure alarm maximum value	B-15
alarm flow pres min	Reports/sets flow pressure alarm minimum value	B-15
alarm flow temp max	Reports/sets flow temperature alarm maximum value	B-15
alarm flow temp min	Reports/sets flow temperature alarm minimum value	B-15
alarm ib status	Reports the interface board status	B-16
alarm io status	Reports the I/O expansion board status	B-16
alarm mb status	Reports the motherboard status	B-16

<b>Command</b>	<b>Description</b>	<b>Page</b>
alarm sample rh max	Reports/sets sample relative humidity alarm maximum value	B-16
alarm sample rh min	Reports/sets sample relative humidity alarm minimum value	B-16
alarm status det	Reports the detector status	B-16
alarm tape counter max	Reports/sets tape counter alarm maximum value	B-17
alarm vac pres max	Reports/sets vacuum pressure alarm maximum value	B-17
alarm vac pres min	Reports/sets vacuum pressure alarm minimum value	B-17
allow mode cmd	Reports/sets the current "set" allow mode command	B-45
alpha eff	Reports/sets the current value of alpha efficiency for the detector	B-27
alpha th	Reports/sets the current value of alpha threshold for the detector	B-28
amb rh	Reports the ambient relative humidity	B-17
amb rh zero	Reports/sets the current ambient relative humidity zero	B-28
amb temp	Reports the current ambient temperature	B-17
amb temp zero	Reports/sets the current ambient temperature zero	B-28
analog iout range	Reports/sets analog current output range per channel	B-50
analog vin	Retrieves analog voltage input data per channel	B-51
analog vout range	Reports/sets analog voltage output range per channel	B-51
avg24 time	Reports/sets 24-hour averaging time to start averaging the concentration	B-9
baro mass coef	Reports/sets the current barometric mass coefficient	B-29
baro pres	Reports the current barometric pressure	B-18
baro span	Reports/sets the current barometric pressure span	B-29
baud	Reports/sets current baud rate	B-46
beta th	Reports/sets the current reference beta threshold for the detector	B-29
bkg pm	Reports/sets current PM background	B-30
board temp	Reports the current board temperature	B-18
cal baro pres span	Automatically calculates the span coefficient	B-30
cal flow pres span	Automatically sets the flow pressure span	B-30
cal flow span	Automatically sets the flow span	B-30
cal vac flow zero	Automatically triggers the filter change and sets vacuum and flow zero	B-31
cal vac pres span	Automatically sets the vacuum pressure span	B-30

## C-Link Protocol Commands

### Commands

<b>Command</b>	<b>Description</b>	<b>Page</b>
clr lrecs	Clears away only lrecs that have been saved	B-20
clr records	Clears away all logging records that have been saved	B-20
clr srecs	Clears away only srecs that have been saved	B-20
coef pm	Reports/sets current PM coefficient	B-31
conc unit	Reports/sets current concentration units	B-35
contrast	Reports/sets current screen contrast	B-41
copy lrec to sp	Sets/copies current lrec selection into the scratch pad	B-21
copy sp to lrec	Sets/copies current selections in scratch pad into lrec list	B-20
copy sp to srec	Sets/copies current selections in scratch pad into srec list	B-20
copy sp to stream	Sets/copies current selections in scratch pad into stream list	B-20
copy srec to sp	Sets/copies current srec selection into the scratch pad	B-21
copy stream to sp	Sets/copies current streaming data selection into the scratch pad	B-21
crn	Reports the current radon concentration	B-18
custom	Reports/sets defined custom range concentration	B-36
data treatment lrec	Reports/sets data treatment for concentration values in lrecs	B-21
data treatment srec	Reports/sets data treatment for concentration values in srecs	B-21
date	Reports/sets current date	B-42
default params	Sets parameters to default values	B-42
det	Reports/sets the status of the detector board	B-42
det status	Reports the current mass for the detector	B-18
dhcp	Reports/sets state of use of Dynamic Host Configuration Protocol (DHCP)	B-47
diag volt det	Reports diagnostic voltage levels on the detector board	B-18
diag volt iob	Reports diagnostic voltage levels on the I/O expansion board	B-18
diag volt mb	Reports diagnostic voltage levels on the motherboard	B-18
diag volt mib	Reports diagnostic voltage levels on the measurement interface board	B-19
dig in	Reports status of the digital inputs	B-52
din	Reports/sets digital input channel and active state	B-52
do (down)	Simulates pressing down pushbutton	B-34
dout	Reports/sets digital output channel and active state	B-52
dtoa	Reports outputs of the digital to analog converters per channel	B-53
en (enter)	Simulates pressing enter pushbutton	B-34

<b>Command</b>	<b>Description</b>	<b>Page</b>
er	Returns a brief description of the main operating conditions in the format specified in the commands	B-22
erec	Returns a snapshot of the main operating conditions (measurements and status) in the specified format	B-22
erec format	Reports/sets erec format	B-24
erec layout	Reports current layout of erec data	B-24
filter period	Reports/sets the number of hours to be added to filter next time for the filter tape change	B-36
filter time	Reports/sets the next date and time of the filter tape change	B-37
flags	Reports current active measurement status flags in HEX	B-10
flow	Reports the current sample flow	B-19
flow pres	Reports the current flow pressure	B-19
flow pres span	Reports/sets the flow pressure span	B-31
flow pres zero	Reports the flow pressure zero	B-31
flow span	Reports/sets the current flow span	B-32
flow target	Reports/sets the current flow	B-37
flow temp	Reports the current flow temperature	B-19
flow temp offset	Reports/sets offset for flow temperature	B-32
format	Reports/sets current reply termination format	B-47
he (help)	Simulates pressing help pushbutton	B-34
high volt	Reports/sets the current high voltage for the detector	B-32
host name	Reports/sets host name string	B-48
ht control	Reports/sets the current status of the heater	B-37
instr name	Reports instrument name	B-48
instrument id	Reports/sets instrument id	B-48
io bd	Reports/sets the presense of the I/O expansion board	B-19
isc (iscreen)	Retrieves framebuffer data used for the display	B-34
layout ack	Reports/disables stale layout/layout changed indicator ("*")	B-49
le (left)	Simulates pressing left pushbutton	B-34
list din	Lists current selection for digital inputs	B-54
list dout	Lists current selection for digital outputs	B-54
list lrec	Lists current selection lrec logging data	B-22
list sp	Lists current selection in the scratchpad list	B-22
list srec	Lists current selection srec logging data	B-22
list stream	Lists current selection streaming data output	B-22

**C-Link Protocol Commands**

## Commands

<b>Command</b>	<b>Description</b>	<b>Page</b>
list var aout	Reports list of analog output, index numbers, and variables	B-54
list var din	Reports list of digital input, index numbers, and variables	B-54
list var dout	Reports list of digital output, index numbers, and variables	B-54
list var log	Reports a list of datalogging index numbers and variables	B-54
lr	Reports the last lrec stored	B-22
lrec	Reports maximum number of lrecs	B-22
lrec format	Reports/sets output format for lrecs (ASCII or binary)	B-24
lrec layout	Reports current layout of lrec data	B-24
lrec mem size	Reports maximum number of lrecs that can be stored	B-24
lrec per	Reports/sets lrec logging period	B-25
malloc lrec	Reports/sets memory allocation for lrecs	B-25
malloc srec	Reports/sets memory allocation for srecs	B-25
mass	Reports the presence of mass	B-19
mass coef	Reports/sets the current mass coefficient	B-32
mass limit	Reports/sets the current filter mass limit	B-38
me (menu)	Simulates pressing menu pushbutton	B-34
no of lrec	Reports number of lrecs stored in memory	B-26
no of srec	Reports number of srecs stored in memory	B-26
pm	Reports the measured PM concentration	B-11
pm 24avg	Reports the 24-hour average PM concentration	B-11
power up mode	Reports/sets the power up mode as local or remote	B-49
pres comp	Reports/sets pressure compensation to actual or standard	B-38
pres std	Reports/sets the standard pressure	B-38
program no	Reports analyzer program number	B-50
pump	Reports/sets pump on or off	B-42
push	Simulates pressing a key on the front panel	B-34
range	Reports/sets current PM range	B-39
relay	Sets relay logic status for the designated relay(s)	B-55
relay stat	Reports relay logic status for all relay(s)	B-55
reset tape counter	Resets the tape count to zero	B-20
rh th	Reports/sets the current relative humidity threshold for the detector	B-40
ri (right)	Simulates pressing right pushbutton	B-34
ru (run)	Simulates pressing run pushbutton	B-34



<b>Command</b>	<b>Description</b>	<b>Page</b>
sample rh	Reports the sample relative humidity	B-20
save	Stores parameters in FLASH	B-43
save params	Stores parameters in FLASH	B-43
sc (screen)	C-series legacy command that reports a generic response (Use iscreen instead)	B-35
sp field	Reports/sets item number and name in scratch pad list	B-26
sr	Reports the last srec stored	B-23
srec	Reports maximum number of srecs	B-22
srec format	Reports/sets output format for srecs (ASCII or binary)	B-24
srec layout	Reports current layout of srec data	B-24
srec mem size	Reports maximum number of srecs that can be stored	B-24
srec per	Reports/sets srec logging period	B-25
stream per	Reports/sets current time interval for streaming data	B-26
stream time	Reports/sets a time stamp to streaming data or not	B-27
tape counter	Reports the number of counts corresponding to the filter tape movement	B-20
temp comp	Reports/sets temperature compensation to actual or standard	B-40
temp std	Reports/sets the standard temperature	B-40
temp th	Reports/sets the temperature threshold for the detector	B-40
thermal mass coef	Reports/sets the current thermal mass coefficient	B-33
time	Reports/sets current time (24-hour format)	B-43
tz	Reports/sets the timezone string for the NTP server	B-50
up	Simulates pressing up pushbutton	B-34
vac mass coef	Reports/sets the current vacuum mass coefficient	B-33
vac pres	Reports the current vacuum pressure	B-20
vac pres span	Reports/sets the vacuum pressure span	B-34
vac pres zero	Reports the vacuum pressure zero	B-34
vf pres cal def	Sets vacuum and flow pressure calibration defaults	B-34

## Measurements

### avg24 time

This command reports the 24 hour averaging time in hours and minutes. The following example shows that the averaging time is set to 18:30.

```
Send:      avg24 time
Receive:   avg24 time 18:30
```

**set avg 24 time *hh:mm***  
*hh* = hours (01 to 23)  
*mm* = minutes (01 to 59)

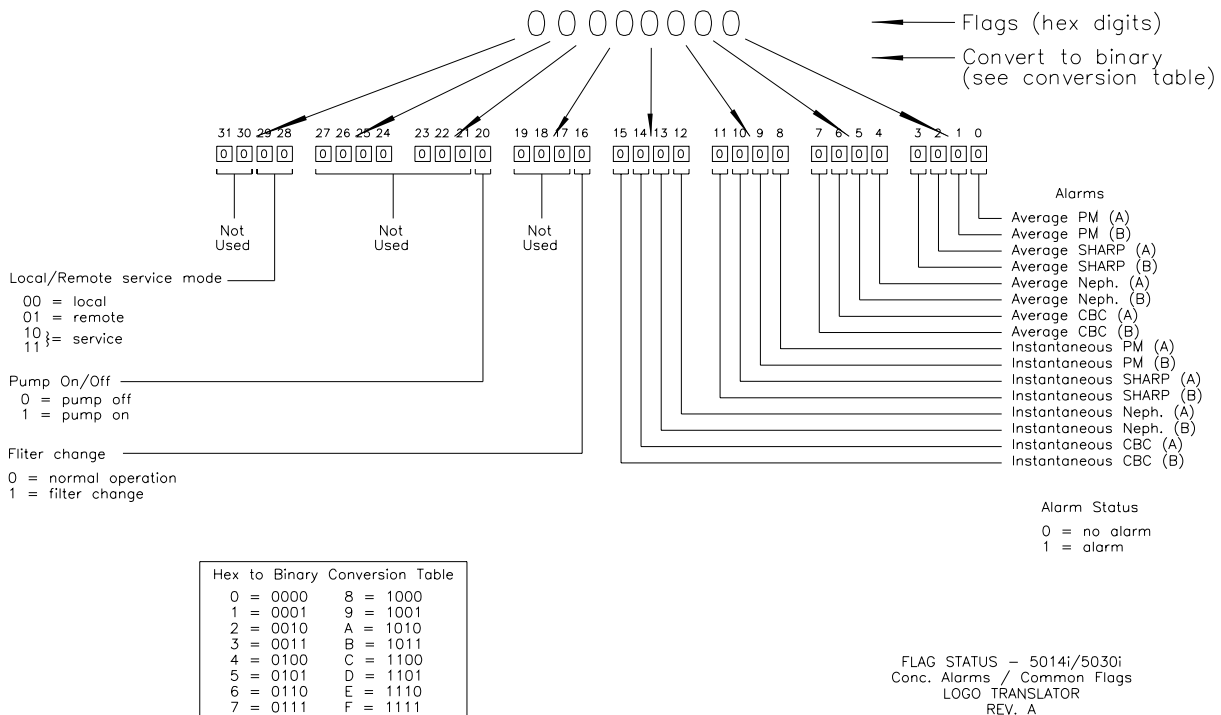
This command sets the 24 hour averaging time to start averaging the concentration from *hh:mm* until next 24 hours. It is then set to next 24 hours automatically. The following example sets the 24 hour averaging time to 17:50.

Send:            set avg24 time 17:50  
 Receive:        set avg24 time 17:50 ok

**flags**

This reports 8 hexadecimal digits (or flags) that represent the status of the mode, pressure and temperature compensation status, concentration units, concentration modes and alarms. To decode the flags, each hexadecimal digit is converted to binary as shown in the [Figure B-1](#). It is the binary digits that define the status of each parameter.

Send:            flags  
 Receive:        flags 00000000



**Figure B-1.** Flags Field

**pm**

This command reports the measured PM concentration. The following example shows that the PM concentration is 14.1 mg/m<sup>3</sup>.

```
Send:          pm
Receive:       pm 1.410E+01 mg/m3
```

**pm 24avg value**

This command reports the 24 hour averaging PM concentration *value*, where *value* is a floating-point number representing PM concentration in the currently selected units. The following example reports the 24 hour PM concentration value.

```
Send:          pm 24avg
Receive:       pm 24avg 10.000E+00 ug/m3
```

## Alarms

**alarm alpha count min****alarm alpha count max**

These commands report the current alpha count alarm minimum and maximum value settings. The following example reports that the alpha count alarm minimum value is 200.

```
Send:          alarm alpha count min
Receive:       alarm alpha count min 200
```

**set alarm alpha count min x****set alarm alpha count max x**

These commands set the alpha count alarm minimum and maximum values to *x*, where *x* is an integer representing alpha count limits. The following example sets the alpha count alarm maximum value to 500.

```
Send:          set alarm alpha count max 500
Receive:       set alarm alpha count max 500 ok
```

**alarm amb rh min****alarm amb rh max**

These commands report the current ambient relative humidity alarm minimum and maximum value settings. The following example reports the ambient relative humidity alarm minimum value is 35.0%.

```
Send:          alarm amb rh min
Receive:       alarm amb rh min 35.0%
```

**set alarm amb rh min value****set alarm amb rh max value**

These commands set the ambient relative humidity alarm minimum and maximum values to *value*, where *value* is a floating-point number representing ambient relative humidity alarm limits in percent. The

following example sets the ambient relative humidity alarm maximum value to 55%.

```
Send:          set alarm amb rh max 55%
Receive:       set alarm amb rh max 55% ok
```

---

**alarm amb temp min**

**alarm amb temp max**

These commands report the current ambient temperature alarm minimum and maximum value settings. The following example reports that the ambient temperature alarm minimum value is 4.0 °C.

```
Send:          alarm amb temp min
Receive:       alarm amb temp min 4.0 degC
```

**set alarm amb temp min *value***

**set alarm amb temp max *value***

These commands set the ambient temperature alarm minimum and maximum values to *value*, where *value* is a floating-point number representing ambient temperature alarm limits in °C. The following example sets the ambient temperature alarm maximum value to 38 °C.

```
Send:          set alarm amb temp max 38.0
Receive:       set alarm amb temp max 38.0 ok
```

---

**alarm baro pres min**

**alarm baro pres max**

These commands report the current barometric pressure alarm minimum and maximum value settings. The following example reports that the barometric pressure alarm minimum value is 500.0 mmHg.

```
Send:          alarm baro pres min
Receive:       alarm baro pres min 500.0 mmHg
```

**set alarm baro pres min *value***

**set alarm baro pres max *value***

These commands set the barometric pressure alarm minimum and maximum values to *value*, where *value* is a floating-point number representing barometric pressure alarm limits in millimeters of mercury. The following example sets the barometric pressure alarm maximum value to 800.0 mmHg.

```
Send:          set alarm baro pres max 800.0
Receive:       set alarm baro pres max 800.0 ok
```

---

**alarm bench status**

This command reports the current status of the bench as FAIL or OK. The following example reports that the bench status is OK.

Send: alarm bench status  
Receive: alarm bench status ok

**alarm beta count min**

**alarm beta count max**

These commands report the current beta count alarm minimum and maximum value settings. The following example reports that the beta count alarm minimum value is 5000.

Send: alarm beta count min  
Receive: alarm beta count min 5000

**set alarm beta count min *value***

**set alarm beta count max *value***

These commands set the beta count alarm minimum and maximum *value*, where *value* is an integer number representing beta count limits. The following example sets the beta count alarm maximum value to 20000.

Send: set alarm beta count max 20000  
Receive: set alarm beta count max 20000 ok

**alarm board temp min**

**alarm board temp max**

These commands report the current board temperature alarm minimum and maximum value settings. The following example reports that the board temperature alarm minimum value is 0 °C.

Send: alarm board temp min  
Receive: alarm board temp min 0.0 degC

**set alarm board temp min *value***

**set alarm board temp max *value***

These commands set the board temperature alarm minimum and maximum values to *value*, where *value* is a floating-point number representing board temperature alarm limits in °C. The following example sets the board temperature alarm maximum value to 38 °C.

Send: set alarm board temp max 38.0  
Receive: set alarm board temp max 38.0 ok

**alarm conc avg pm min**

**alarm conc avg pm max**

These commands report the current 24-hour average PM concentration alarm minimum and maximum values setting. The following example reports that the average PM concentration minimum is 100 mg/m<sup>3</sup>.

Send: alarm conc avg pm min  
Receive: alarm conc avg pm min 1.000E+02 mg/m3

**set alarm conc avg pm min *value***  
**set alarm conc avg pm max *value***

These commands set the 24-hour average PM concentration alarm minimum and maximum values to *value*, where *value* is a floating-point representation of the concentration alarm limits. Values must be in the units that are currently set for use. The following example sets the average PM concentration alarm maximum value to 10000 mg/m<sup>3</sup>.

Send: set alarm conc avg pm max 10000  
Receive: set alarm conc avg pm max 10000 ok

---

**alarm conc inst pm min**  
**alarm conc inst pm max**

These commands report the current 24-hour instant PM concentration alarm minimum and maximum values setting. The following example reports that the instant PM concentration minimum is 100 µg/m<sup>3</sup>.

Send: alarm conc inst pm min  
Receive: alarm conc inst pm min 1.000E+02 µg/m3

**set alarm conc inst pm min *value***  
**set alarm conc inst pm max *value***

These commands set the 24-hour instant PM concentration alarm minimum and maximum values to *value*, where *value* is a floating-point representation of the concentration alarm limits. Values must be in the units that are currently set for use. The following example sets the instant PM concentration alarm maximum value to 10000 µg/m<sup>3</sup>.

Send: set alarm conc inst pm max 10000  
Receive: set alarm conc inst pm max 10000 ok

---

**alarm filter tape status**

This command reports the status of the filter tape as FAIL or OK. The following example reports that the filter tape status is OK.

Send: alarm filter tape status  
Receive: alarm filter tape status ok

---

**alarm flow min**  
**alarm flow max**

These commands report the current flow alarm minimum and maximum value settings. The following example reports that the flow alarm minimum value is 16.0 LPM.

Send: alarm flow min  
Receive: alarm flow min 16.00 LPM

**set alarm flow min *value***

**set alarm flow max *value***

These commands set the flow alarm minimum and maximum values to *value*, where *value* is a floating-point number representing flow alarm limits in liters per minute/liters per hour. The following example sets the flow alarm maximum value to 17.34 LPM.

```
Send:          set alarm flow max 17.34
Receive:       set alarm flow max 17.34 ok
```

---

**alarm flow pres min**

**alarm flow pres max**

These commands report the current flow pressure alarm minimum and maximum value settings. The following example reports that the flow pressure alarm minimum value is -10.0 mmHg.

```
Send:          alarm flow pres min
Receive:       alarm flow pres min -10.0 mmHg
```

**set alarm flow pres min *value***

**set alarm flow pres max *value***

These commands set the flow pressure alarm minimum and maximum values to *value*, where *value* is a floating-point number representing flow pressure alarm limits in millimeters of mercury. The following example sets the flow pressure alarm maximum value to 100.0 mmHg.

```
Send:          set alarm flow pres max 100.0
Receive:       set alarm flow pres max 100.0 ok
```

---

**alarm flow temp min**

**alarm flow temp max**

This command reports the current flow temperature alarm maximum value setting. The following example reports that the flow temperature alarm maximum value is 20.0 °C.

```
Send:          alarm flow temp max
Receive:       alarm flow temp max 20.0 degC
```

**set alarm flow temp min *value***

**set alarm flow temp max *value***

This command sets the flow temperature alarm maximum value to *value*, where *value* is a floating-point number representing flow temperature alarm limits in °C. The following example sets the flow temperature alarm maximum value to 70 °C.

```
Send:          set alarm flow temp max 70.0
Receive:       set alarm flow temp max 70.0 ok
```

---

**alarm ib status**

This command reports the status of the interface board as FAIL or OK. The following example reports that the interface board status is OK.

```
Send:      alarm ib status
Receive:   alarm ib status ok
```

---

**alarm io status**

This command reports the status of the I/O expansion board as FAIL or OK. The following example reports that the I/O expansion board status is OK.

```
Send:      alarm io status
Receive:   alarm io status ok
```

---

**alarm mb status**

This command reports the status of the motherboard as FAIL or OK. The following example reports that the motherboard status is OK.

```
Send:      alarm mb status
Receive:   alarm mb status ok
```

---

**alarm sample rh min****alarm sample rh max**

These commands report the current sample relative humidity alarm minimum and maximum value settings. The following example reports that the sample relative humidity alarm minimum value is 5%.

```
Send:      alarm sample rh min
Receive:   alarm sample rh min 5.0%
```

**set alarm sample rh min *value*****set alarm sample rh max *value***

These commands set the sample relative humidity alarm minimum and maximum values to *value*, where *value* is a floating-point number representing sample relative humidity alarm limits in percent. The following example sets the sample relative humidity alarm maximum value to 40%.

```
Send:      set alarm sample rh min 40.0
Receive:   set alarm sample rh min 40.0 ok
```

---

**alarm status det**

This command reports the board status of the detector as FAIL or OK. The following example reports that the detector board status is OK.

```
Send:      alarm status det
Receive:   alarm status det ok
```



---

**alarm tape counter max**

This command reports the current filter tape count alarm maximum value setting. The following example reports that the filter tape count alarm maximum value is 480.

```
Send:      alarm filter tape counter max
Receive:   alarm filter tape counter max 480
```

**set alarm filter tape counter max *value***

This command sets the filter tape count alarm maximum *value*, where *value* is an integer number representing filter tape alarm limits. The following example sets the filter tape count alarm maximum value to 490.

```
Send:      set alarm filter tape counter max 490
Receive:   set alarm filter tape counter max 490 ok
```

---

**alarm vac pres min****alarm vac pres max**

These commands report the current vacuum pressure alarm minimum and maximum value settings. The following example reports that the vacuum pressure alarm minimum value is -20.0 mmHg.

```
Send:      alarm vac pres min
Receive:   alarm vac pres min -20.0 mmHg
```

**set alarm vac pres min *value*****set alarm vac pres max *value***

These commands set the vacuum pressure alarm minimum and maximum values to *value*, where *value* is a floating-point number representing vacuum pressure alarm limits in millimeters of mercury. The following example sets the vacuum pressure alarm maximum value to 250.0 mmHg.

```
Send:      set alarm vac pres max 250.0
Receive:   set alarm vac pres max 250.0 ok
```

## Diagnostics

---

**amb rh**

This command reports the ambient RH, in percent. The following example reports that the ambient RH is 30%.

```
Send:      amb rh
Receive:   amb rh 30.0%
```

---

**amb temp**

This command reports the current ambient temperature, in degrees C. The following example reports that the ambient temperature is 15 °C.

```
Send:      amb temp
Receive:   amb temp 15.0 degC
```

---

**baro pres**

This command reports the current barometric pressure, in mmHg. The following example reports that the barometric pressure is 722 mmHg.

Send: baro pres  
Receive: baro pres 722.0 mmHg

---

**board temp**

This command reports the current board temperature, in degrees C. The following example reports that the board temperature is 15 °C.

Send: board temp  
Receive: board temp 15.0 degC

---

**crn**

This command reports the current radon concentration for the detector. The following example reports that the radon concentration is 1.2 Bq/m<sup>3</sup>.

Send: crn  
Receive: crn 1.20 Bq/m3

---

**det status**

This command reports the current mass for the detector. The sequence is:  $\beta_c$ ,  $\beta$ ,  $\alpha$ . Each value is separated by a space.

Send: det status  
Receive: det status 30000 25000 500

---

**diag volt det**

This command reports the diagnostic voltage measurements on the detector board. The voltage is positive 5.

Send: diag volt det  
Receive: diag volt det 4.9

---

**diag volt iob**

This command reports the diagnostic voltage measurements on the I/O expansion board. The sequence of voltages is: Positive 24, positive 5, positive 3.3, and negative 3.3. Each voltage value is separated by a space.

Send: diag volt iob  
Receive: diag volt iob 24.10 4.90 3.20 -3.20

---

**diag volt mb**

This command reports the diagnostic voltage measurements on the motherboard. The sequence of voltages is: Positive 24, positive 15, positive 5, positive 3.3, and negative 3.3. Each voltage value is separated by a space.

```
Send:      diag volt mb
Receive:   diag volt mb 24.10 14.90 4.90 3.20 -3.20
```

### **diag volt mib**

This command reports the diagnostic voltage measurements on the measurement interface board. The sequence of voltages is: Positive 24, positive 15, negative 15, positive 5, and positive 3.3. Each voltage value is separated by a space.

```
Send:      diag volt mib
Receive:   diag volt mib 24.98 14.80 -14.90 4.96 3.20
```

### **flow**

This command reports the current sample flow. The following example reports that the sample flow is 16.69 LPM.

```
Send:      sample flow
Receive:   sample flow 16.69 LPM
```

### **flow pres**

This command reports the current flow pressure for the detector, in mmHg. The following example reports that the flow pressure is 24.1 mmHg.

```
Send:      flow pres
Receive:   flow pres 24.1 mmHg
```

### **flow temp**

This command reports the current flow temperature for the detector, in degrees C. The following example reports that the flow temperature is 22.3 °C.

```
Send:      flow temp
Receive:   flow temp 22.3 deg
```

### **io bd**

This command reports the presence of the I/O expansion board (yes/no). The following example reports the I/O expansion board is present (yes).

```
Send:      io bd
Receive:   io bd yes
```

### **mass**

This command reports the presence of mass. The following example reports that the mass is 0.1 mg/m<sup>3</sup>.

```
Send:      mass
Receive:   mass 0.1 mg/m3
```

---

**set reset tape counter**

This command resets the tape count to zero.

Send: set reset tape counter  
Receive: set reset tape counter ok

---

**sample rh**

This command reports the sample RH, in percent. The following example reports that the sample RH is 20%.

Send: sample rh  
Receive: sample rh 20.0%

---

**tape counter**

This command reports the number counts which corresponds to the filter tape movement. The following example reports that the tape count is 250.

Send: tape counter  
Receive: tape counter 250

---

**vac pres**

This command reports the current vacuum pressure for the detector, in mmHg. The following example reports that the vacuum pressure is 100 mmHg.

Send: vac pres  
Receive: vac pres 100.0 mmHg

---

## Datalogging

---

**clr records**

This command will clear all lrecs and srecs that have been saved.

Send: clr records  
Receive: clr records ok

**set clr lrecs**

**set clr srecs**

These commands will clear only the lrecs or only the srecs that have been saved. The following example clears srecs.

Send: set clr srecs  
Receive: set clr srecs ok

---

**set copy sp to lrec**

**set copy sp to srec**

**set copy sp to stream**

These commands copy the current selections in scratch pad (sp) into the lrec, srec, or streaming data list.

The scratch pad is a temporary memory area which is used to set up lists of selections for lrec, srec, or streaming data items. The user can copy any of these lists to the scratch pad, modify individual elements in the list, then save the scratch pad back to the original list. For more information on how to edit the scratch pad, see the “sp field” command.

The following example copies the current list in scratch pad into the lrecs list.

```
Send:      set copy sp to lrec
Receive:   set copy sp to lrec ok
```

**set copy lrec to sp**

**set copy srec to sp**

**set copy stream to sp**

These commands copy the current contents of the lrec, srec, or streaming data list into the scratch pad (sp). These commands are useful in easy modification of current lrec, srec, or streaming data lists.

The scratch pad is a temporary memory area which is used to set up lists of selections for lrec, srec, or streaming data items. The user can copy any of these lists to the scratch pad, modify individual elements in the list, then save the scratch pad back to the original list. For more information on how to edit the scratch pad, see the “sp field” command.

The following example copies the current list of lrecs into the scratch pad.

```
Send:      set copy lrec to sp
Receive:   set copy lrec to sp ok
```

**data treatment lrec**

**data treatment srec**

These commands report the current selection of data treatment for concentrations in the lrecs or srecs. The following example reports the data treatment for concentrations in lrec as minimum.

```
Send:      data treatment lrec
Receive:   data treatment lrec min
```

**set data treatment lrec *string***

**set data treatment srec *string***

*string* = | cur | avg | min | max |

These commands set the data treatment to current, average, minimum, or maximum for the concentration values recorded in the lrecs or srecs. The following example sets the data treatment for concentrations in lrec as minimum.

```
Send:      set data treatment lrec min
Receive:   set data treatment lrec min ok
```

---

**erec**

**erxy**

$x = | 0 | 1 |$  : Reply termination format (see “set format *format*” command)

$y = | 0 | 1 | 2 |$  : Output format (see “set erex format *format*” command)

These commands return a snapshot of the main operating conditions (measurements and status) at the time the command is issued. The following example shows a typical response.

The format is defined within the command (in the case of *erxy*) by the current settings of the “format” and “erex format” commands (in the case of *erec*). For details on *erec* formatting, see the “[Record Layout Definition](#)” section at the end of this appendix. For details on how to decode the flag fields within these records, see the “flags” command.

```
Send:      erex
Receive:   erex
           07:53 05-04-09 flags 110000 PM 0.000 1 24Hr Avg PM
           0.000 1 Coef A 1.000 Bkg A 0.000 Range A 10000.000 Flow
           A 0.000 6 5 3 1 1 1 0 Temp Threshold A 30.000 Temp
           Threshold A 35.000
```

---

**list lrec**

**list srec**

**list stream**

**list sp**

These commands report the list of current selections for *lrec* logging data, *srec* logging data, streaming data output, or the scratch pad (*sp*) list.

The scratch pad is a temporary memory area which is used to set up lists of selections for *lrec*, *srec*, or streaming data items. The user can copy any of these lists to the scratch pad, modify individual elements in the list, then save the scratch pad back to the original list. Refer to the “*sp* field” command for information on how to edit the scratch pad.

The following example shows the list for streaming data output.

```
Send:      list stream
Receive:   list stream
           field index variable
           X x time
```

---

**lrec**

**srec**

**lrec** *rec num*

**srec** *rec num*

**lrx** *rec num*

*srxxy rec num*  
**lrec aa:bb oo-pp-qq yy**  
**srec aa:bb oo-pp-qq yy**  
*rec* = The starting record index number (1=most recent)  
*num* = The number of records to return (1 to 10)  
*x* = | 0 | 1 | : Reply termination format (see “set format *format*”  
 command)  
*y* = | 0 | 1 | 2 | : Output format (see “set lrec/srec format *format*”  
 command)  
*aa* = hours (01 to 23)  
*bb* = minutes (01 to 59)  
*oo* = month (01 to 12)  
*pp* = day (01 to 31)  
*qq* = year

These commands output lrec or srec logged data. The output format is determined by the “set lrec format”, and “set srec format” commands. The logging time is determined by the “set lrec per” and “set srec per” commands.

In the following example, assume there are 740 lrecs currently stored in memory. When the command “lrec 100 5” is sent, the instrument counts back 100 records from the last record collected (record 740), and then returns 5 records: 640, 641, 642, 643, and 644. For details on how to decode the flag fields within these records, see the “flags” command.

```
Send:          lrec 5
Receive:       lrec 100 5
              08:28 05-04-09 flags 00110000 pm 0.000 baro 0.000 vac -
              260.000 pflow -52.000 ambrh 0.000 srh 0.000 ambtemp -
              32.000 stemp -41.000 fvol 0.000 cflg 00001F86 aflg
              0000FC0C
              08:29 05-04-09 flags 00110000 pm 0.000 baro 0.000 vac -
              260.000 pflow -52.000 ambrh 0.000 srh 0.000 ambtemp -
              32.000 stemp -41.000 fvol 0.000 cflg 00001F86 aflg
              0000FC0C
              08:30 05-04-09 flags 00110000 pm 0.000 baro 0.000 vac -
              260.000 pflow -52.000 ambrh 0.000 srh 0.000 ambtemp -
              32.000 stemp -41.000 fvol 0.000 cflg 00001F86 aflg
              0000FC0C
              08:31 05-04-09 flags 00110000 pm 0.000 baro 0.000 vac -
              260.000 pflow -52.000 ambrh 0.000 srh 0.000 ambtemp -
              32.000 stemp -41.000 fvol 0.000 cflg 00001F86 aflg
              0000FC0C
              08:32 05-04-09 flags 00110000 pm 0.000 baro 0.000 vac -
              260.000 pflow -52.000 ambrh 0.000 srh 0.000 ambtemp -
              32.000 stemp -41.000 fvol 0.000 cflg 00001F86 aflg
              0000FC0C
```

---

**lrec format**  
**srec format**  
**erec format**

These commands report the output format for lrecs and srecs, and erec data in various formats such as ASCII without text, ASCII with text, or binary. The following example shows the output format for lrecs is ASCII with text, according to [Table B-3](#).

```
Send:          lrec format
Receive:       lrec format 1
```

**set lrec format *format***  
**set srec format *format***  
**set erec format *format***

These commands set the output format for lrecs and srecs, and erec data, according to [Table B-3](#). The following example sets the lrec output format to ASCII with text.

```
Send:          set lrec format 1
Receive:       set lrec format 1 ok
```

**Table B-3.** Record Output Formats

<i>Format</i>	<b>Output Format</b>
0	ASCII no text
1	ASCII with text
2	Binary data

---

**lrec layout**  
**srec layout**  
**erec layout**

These commands report the layout (string indicating the data formats) for data that is sent out in response to the lrec, srec, erec, and related commands. For details on how to interpret the strings, see “Record Layout Definition” later in this appendix.

```
Send:          lrec layout
Receive:       lrec layout %s %s %lx %f %f %f %f %f %f %f %f %f %f %lx
               %lx
               t D L ffffffff A A
               flags pm baro vac pflow ambrh srh ambtemp stemp fvol
               dflg aflg
```

---

**lrec mem size**  
**srec mem size**



These commands report the number of lrecs and srecs that can be stored with the current settings and the number of blocks reserved for lrecs and srecs. The following example shows that 1075 blocks were reserved for lrecs and the maximum number of lrecs that can be stored in memory is 241979. Memory allocation can be changed using the “malloc” command.

```
Send:      lrec mem size
Receive:   lrec mem size 241979 recs, 1075 blocks
```

### **lrec per** **srec per**

These commands report the lrecs and srecs logging period. The following example shows that the srec logging period is 5 minutes.

```
Send:      srec per
Receive:   srec per 5 min
```

```
set lrec per value
set srec per value
value = | 1 | 5 | 15 | 30 | 60 |
```

These commands set the lrecs and srecs logging period to *value* in minutes. The following example sets the lrec logging period to 15 minutes.

```
Send:      set lrec per 15
Receive:   set lrec per 15 ok
```

### **malloc lrec** **malloc srec**

These commands report the currently set memory allocation for lrecs and srecs in percent of total memory.

```
Send:      malloc lrec
Receive:   malloc lrec 10 %
```

```
set malloc lrec value
set malloc srec value
value = 0 to 100
```

These commands set the percent of memory space allocated for lrecs and srecs to *value*, where *value* is a floating-point number representing percent. The following example sets the memory allocation for lrecs to 10%.

**Note** Issuing these commands will clear all the logged data in memory. All the existing records should be retrieved using appropriate commands, if required. ▲

```
Send:      set malloc lrec 10
Receive:   set malloc lrec 10 ok
```

---

**no of lrec**

**no of srec**

These commands report the number of lrec and srecs stored memory. The following example shows that 50 lrecs have been stored in the memory.

```
Send:      no of lrec
Receive:   no of lrec 50 recs
```

---

**sp field *number***

This command reports the variable *number* and name stored at the index in the scratch pad list.

The scratch pad is a temporary memory area which is used to set up lists of selections for lrec, srec, or streaming data items. The user can copy any of these lists to the scratch pad, modify individual elements in the list, then save the scratch pad back to the original list.

The following example shows that field 1 in the scratch pad is set to index number 3, which is for the variable PM concentration pressure.

```
Send:      sp field 1
Receive:   sp field 1 3 PM
```

---

**set sp field *number value***

*number* = 1-32 for lrec and srec lists, 1-8 for streaming data lists

This command sets the scratch pad field *number* (item number in scratch pad list) to *value*, where *value* is the index number of a variable in the analog output variable list. Available variables and their corresponding index numbers may be obtained using the command “list var aout”. The “set sp field” command is used to create a list of variables which can then be transferred into the lrec, srec, or streaming data lists, using the “set copy sp to lrec”, “set copy sp to srec”, or “set copy sp to stream” commands.

```
Send:      set sp field 1 34
Receive:   set sp field 1 34 ok
```

---

**stream per**

This command reports the current time interval in seconds for streaming data. The following example reports the streaming period is set to 10 seconds.

```
Send:      stream per
Receive:   stream per 10 sec
```

**set stream per *number value***

*number value* = | 1 | 2 | 5 | 10 | 20 | 30 | 60 | 90 | 120 | 180 | 240 | 300 |

This command sets the time interval between two consecutive streaming data strings to *number value* in seconds. The following example sets the number value to 10 seconds.

Send:            set stream per 10  
Receive:         set stream per 10 ok

**stream time**

This command reports if the streaming data string will have a time stamp attached to it or not, according to [Table B-4](#). The following example reports that the streaming data shall not include a time stamp.

Send:            stream time  
Receive:         stream time 0

**set stream time *value***

This command enables *value*, where *value* is to attach or disable time stamp to streaming data string, according to [Table B-4](#). The following example attaches a time stamp to streaming data.

Send:            set stream time 1  
Receive:         set stream time 1 ok

**Table B-4.** Stream Time Values

<i>Value</i>	<b>Stream Time</b>
0	Disables time stamp to streaming data string
1	Attaches time stamp to streaming data string

## Calibration

**alpha eff**

This command reports the current value of alpha efficiency for the detector. The following example reports that the alpha efficiency is 0.12.

Send:            alpha eff  
Receive:         alpha eff 0.120

**set alpha eff *value***

This command sets the alpha efficiency for the detector to *value*, where *value* is a floating-point number representing the alpha efficiency for the detector. The following example sets the alpha efficiency to 0.15.

Send:            set alpha eff 0.15  
Receive:         set alpha eff 0.150 ok

---

### **alpha th**

This command reports the current value of alpha threshold for the detector. The following example reports that the alpha threshold is 1220.

```
Send:      alpha th
Receive:   alpha th 1220
```

### **set alpha th *value***

This command sets the alpha threshold for the detector to *value*, where *value* is a floating-point number representing the alpha threshold for the detector. The following example sets the alpha threshold to 1250.

```
Send:      set alpha th 1250
Receive:   set alpha th 1250 ok
```

---

### **amb rh zero**

This command reports the current ambient RH zero, in percent. The following example reports that the ambient RH zero is 0.6%.

```
Send:      amb rh zero
Receive:   amb rh zero 0.6%
```

### **set amb rh zero *value***

This command sets the ambient RH zero to *value*, where *value* is a floating-point number representing ambient RH zero in percent. The following example sets the ambient RH zero to 7%.

```
Send:      set amb rh zero 7
Receive:   set amb rh zero 7 ok
```

---

### **amb temp zero**

This command reports the current ambient temperature zero, in degrees C. The following example reports that the ambient temperature zero is 5 °C.

```
Send:      amb temp zero
Receive:   amb temp zero 5.0 degC
```

### **set amb temp zero *value***

This command sets the ambient temperature zero to *value*, where *value* is a floating-point number representing ambient temperature zero in degrees C. The following example sets the ambient temperature zero to 3 °C.

```
Send:      set amb temp zero 3
Receive:   set 3 amb temp zero 3 ok
```

---

**baro mass coef**

This command reports the current barometric mass coefficient. The following example reports that the barometric mass coefficient is 0.000540.

```
Send:      baro mass coef
Receive:   baro mass coef 0.000540
```

**set baro mass coef *value***

This command sets the barometric mass coefficient to user-defined values to *value*, where *value* is a floating-point representation of the coefficient. The following example sets the barometric mass coefficient to 0.000630.

```
Send:      set baro mass coef 0.000630
Receive:   set baro mass coef 0.000630 ok
```

---

**baro span**

This command reports the current barometric pressure span recorded at the time of calibration. The following example reports that the barometric span is 1.0.

```
Send:      baro span
Receive:   baro span 1.0000
```

**set baro span *value***

This command requires to manually specifying the span *value* for the barometric pressure span, where *value* is a floating-point representation of barometric pressure span. The following example successfully sets the barometric span to 1.023.

```
Send:      set baro span 1.023
Receive:   set baro span 1.023 ok
```

---

**beta th**

This command reports the current reference beta threshold for the detector. The following example reports that the beta threshold is 440.

```
Send:      beta th
Receive:   beta th 440
```

**set beta th *value***

This command sets the reference beta threshold for the detector to *value*, where *value* is a floating-point representation of the beta threshold. The following example sets the beta threshold to 500.

```
Send:      set beta th 500
Receive:   set beta th 500 ok
```

---

### **bkg pm**

This command reports the current PM backgrounds. The following example reports that the PM background is 4  $\mu\text{g}/\text{m}^3$ .

```
Send:          bkg pm
Receive:       bkg pm 4.000E+00  $\mu\text{g}/\text{m}^3$ 
```

### **set bkg pm *value***

This command is used to set PM backgrounds to user-defined values to *value*, where *value* is a floating-point representation of the background in current selected units. The following example sets the PM background to 5.2  $\mu\text{g}/\text{m}^3$ .

```
Send:          set bkg pm 5.2
Receive:       set bkg pm 5.2 ok
```

---

### **set cal baro pres span**

This command automatically calculates the span coefficient based on the entered target pressure value. The following example sets the calibration pressure to 720.5 mmHg.

```
Send:          set cal baro offset 720.5
Receive:       set cal baro offset 720.5 ok
```

---

### **set cal flow pres span**

This command automatically sets the flow pressure span based on the flow pressure entered at the time of calibration. The following example successfully sets the new value for flow span based on the flow pressure to 50.5 mmHg.

```
Send:          set cal flow pres span 50.5
Receive:       set cal flow pres span 50.5 ok
```

---

### **set cal flow span**

This command automatically sets the new value for flow span based on the corrected flow entered. The following example sets the new value for flow span based on the corrected flow to 17.2 LPM.

```
Send:          set cal flow span 17.2
Receive:       set cal flow span 17.2 ok
```

---

### **set cal vac pres span**

This command automatically sets the vacuum span based on the vacuum pressure entered at the time of calibration. The following example successfully sets the new value for vacuum span based on the vacuum pressure to 120.5 mmHg.

```
Send:      set cal vac pres span 120.5
Receive:   set cal vac pres span 120.5 ok
```

#### **set cal vac flow zero**

This command automatically triggers the filter change and sets the new value for vacuum and flow zero. The following example successfully sets the vacuum and flow zero.

```
Send:      set cal vac flow zero
Receive:   set cal vac flow zero ok
```

#### **coef pm**

This command reports PM coefficient. The following example reports that the PM coefficient is 1.200.

```
Send:      coef pm
Receive:   coef pm 1.200
```

#### **set coef pm *value***

This command sets the PM coefficient to user-defined values to *value*, where *value* is a floating-point representation of the coefficient. The following example sets the PM coefficient to 1.200.

```
Send:      set coef pm 1.200
Receive:   set coef pm 1.200 ok
```

#### **flow pres span**

This command reports the flow pressure span recorded at the time of calibration. The following example reports that the flow span is 1.2.

```
Send:      flow pres span
Receive:   flow pres span 1.200
```

#### **set flow pres span *value***

This command sets the flow pressure span to *value*, where *value* is a floating-point representation of the pressure span specified at the time of calibration. The following example successfully sets the new value for flow pressure to 1.5.

```
Send:      set flow pres span 1.5
Receive:   set flow pres span 1.5 ok
```

#### **flow pres zero**

This command reports the flow pressure zero for the detector at the time of calibration. The following example reports that the flow pressure zero is 3.0.

```
Send:      flow pres zero
Receive:   flow pres zero 3.0
```

---

**flow span**

This command reports the current flow span at the time of calibration. The following example reports that the flow at calibration is 1.00.

Send: flow span  
Receive: flow span 1.000

**set flow span *value***

This command sets the current flow span to the *value*, where *value* is a floating-point representation of the flow span specified at the time of calibration. The following example sets the flow span to 1.5.

Send: set flow span 1.5  
Receive: set flow span 1.5 ok

---

**flow temp offset**

This command reports offset for flow temperature, in degrees C. The following example reports that the flow temperature offset is 5 °C.

Send: flow temp offset  
Receive: flow temp offset 5.0 degC

**set flow temp offset *value***

This command sets the offset *value* for flow temperature, where *value* is a floating-point number representing flow temperature offset in degrees C. The following example sets the flow temperature offset to 7 °C.

Send: set flow temp offset 7  
Receive: set flow temp offset 7 ok

---

**high volt**

This command reports the current high voltage for the detector. The following example reports that the high voltage is 1400 V.

Send: high volt  
Receive: high volt 1400

**set high volt *value***

This command sets the high voltage for the detector to *value*, where *value* is a floating-point representation of the high voltage. The following example sets the high voltage to 1445 V.

Send: set high volt 1445  
Receive: set high volt 1445 ok

---

**mass coef**

This command reports the current mass coefficient. The following example reports that the mass coefficient is 7100.



```
Send:      mass coef
Receive:   mass coef 7100
```

**set mass coef *value***

This command sets the mass coefficient to user-defined values to *value*, where *value* is a floating-point representation of the coefficient. The following example sets the mass coefficient to 7000.

```
Send:      set mass coef 7000
Receive:   set mass coef 7000 ok
```

---

**thermal mass coef**

This command reports the current thermal mass coefficient. The following example reports that the thermal mass coefficient is 19.0000.

```
Send:      thermal mass coef
Receive:   thermal mass coef 19.0000
```

**set thermal mass coef *value***

This command sets the thermal mass coefficient to user-defined values to *value*, where *value* is a floating-point representation of the coefficient. The following example sets the thermal mass coefficient to 20.5.

```
Send:      set thermal mass coef 20.5
Receive:   set thermal mass coef 20.5 ok
```

---

**vac mass coef**

This command reports the current vacuum mass coefficient. The following example reports that the vacuum mass coefficient is 2.0.

```
Send:      vac mass coef
Receive:   vac mass coef 2.0
```

**set vac mass coef *value***

This command sets the vacuum mass coefficient to user-defined values to *value*, where *value* is a floating-point representation of the coefficient. The following example sets the vacuum mass coefficient to 3.1.

```
Send:      set vac mass coef 3.1
Receive:   set vac mass coef 3.1 ok
```

---

**vac pres span**

This command reports the vacuum span for the detector at the time of calibration. The following example reports that the vacuum pressure span is 1.0.

```
Send:      vac pres span
Receive:   vac pres span 1.000
```

**set vac pres span**

This command sets the vacuum span to the value specified at the time of calibration. The following example successfully sets the new value for vacuum pressure span to 1.002.

Send:           set vac pres zero 1.002  
Receive:       set vac pres zero 1.002 ok

---

**vac pres zero**

This command reports the vacuum zero for the detector at the time of calibration. The following example reports that the vacuum pressure zero is 0.3.

Send:           vac pres zero  
Receive:       vac pres zero 0.3

---

**set vf pres cal def**

This command resets the vacuum and flow pressure calibration to their default values.

Send:           set vf pres cal def  
Receive:       set vf pres cal def ok

---

## Keys/Display

**push *button***

<b>do</b>	<b>me</b>	<b>1</b>
<b>down</b>	<b>menu</b>	<b>2</b>
<b>en</b>	<b>ri</b>	<b>3</b>
<b>enter</b>	<b>right</b>	<b>4</b>
<b>he</b>	<b>ru</b>	
<b>help</b>	<b>run</b>	
<b>le</b>	<b>up</b>	
<b>left</b>		

*button* = | do | down | en | enter | he | help | le | left | me | menu | ri | right | ru | run | up | 1 | 2 | 3 | 4 |

These commands simulate pressing the front panel pushbuttons. The numbers represent the front panel soft keys, from left to right.

Send:           push enter  
Receive:       push enter ok

---

**isc**

**iscreen**

These commands retrieve the framebuffer data used for the display on the *iSeries* instrument. It is 19200 bytes in size, 2-bits per pixel, 4 pixels per byte arranged as 320 by 240 characters. The data is sent in RLE encoded form to save time in transmission. It is sent as a type '5' binary C-Link response with no checksum.

The RLE encoding consists of a 0 followed by an 8-bit count of consecutive 0xFF bytes. The following 'c' code will expand the incoming data.

```
void      unpackDisplay ( void far* tdib, unsigned char far* rlescreen )
{
  int i,j,k;
  unsigned char far *sc4bpp, *sc2bpp, *screen, *ptr;

  ptr = screen = (unsigned char far *)malloc(19200);
  //RLE decode the screen
  for (i=0; i<19200 && (ptr - screen) < 19200; i++)
  {
    *(ptr++) = *(rlescreen + i);
    if (*(rlescreen + i) == 0)
    {
      unsigned char rlecount = *(unsigned char *)(rlescreen + ++i);

      while (rlecount)
      {
        *(ptr++) = 0;
        rlecount--;
      }
    }
    else if (*(rlescreen + i) == 0xff)
    {
      unsigned char rlecount = *(unsigned char *)(rlescreen + ++i);

      while (rlecount)
      {
        *(ptr++) = 0xff;
        rlecount--;
      }
    }
  }
}
```

To convert this data into a BMP for use with Windows, it needs to be saved as a 4-bit-per-pixel gray-scale image. Also note that BMP files are upside down relative to this data, that is, the top display line is the last line in the BMP.

---

**sc**

**screen**

These commands are meant for backward compatibility with the C series. Screen information is instead reported using the “iscreen” command above.

Send: screen  
Receive: screen This is an iSeries instrument.  
Screen information not available.

## Measurement Configuration

---

**conc unit**

This command reports the current concentration units (mg/m<sup>3</sup> or µg/m<sup>3</sup>). The following example reports that the concentration units are set to mg/m<sup>3</sup>.

Send: conc unit  
Receive: conc unit µg/m3

**set conc unit *unit***

*unit* = |  $\mu\text{g}/\text{m}^3$  |  $\text{mg}/\text{m}^3$  |

This command sets the concentration units to  $\text{mg}/\text{m}^3$  or  $\mu\text{g}/\text{m}^3$ . The following example sets the concentration units to  $\text{mg}/\text{m}^3$ .

Send: set conc unit mg/m3  
Receive: set conc unit mg/m3 ok

---

**custom *range***

*range* = | 1 | 2 | 3 |

This command reports the user-defined value of custom *range* 1, 2, or 3. The following example reports that custom range 1 is defined to 5.50  $\text{mg}/\text{m}^3$ .

Send: custom 1  
Receive: custom 1 5.500E+00 mg/m3

---

**set custom *range range value***

**set custom 1 *value***

**set custom 2 *value***

**set custom 3 *value***

These commands are used to set the maximum concentration for any of the three custom *ranges* 1, 2, or 3 to *value*, where *value* is a floating-point number representing concentration in the currently selected units. The following example sets the custom 1 range to 100.5  $\mu\text{g}/\text{m}^3$ .

Send: set custom 1 100.5  $\mu\text{g}/\text{m}^3$   
Receive: set custom 1 100.5  $\mu\text{g}/\text{m}^3$  ok

---

**filter period**

This command reports the number of hours to be added to filter next time for the filter tape change. The following example reports that the filter period is eight hours.

Send: filter period  
Receive: filter period 8 HRS

---

**set filter period *value***

This command sets the number of hours to be added to filter next time for the filter tape change to *value*, where *value* is a floating-point representation of the filter period in hours. The following example sets the filter period to 10 hours.

Send: set filter period 10  
Receive: set filter period 10 ok

---

### filter time

This command reports the next date and time of the filter tape change. The following example reports that the date and time is January 1, 2008, 6:12 pm.

```
Send:      filter time
Receive:   filter time 01Jan08 18:12
```

### set filter time *dd-mm-yyyy hh:mm:ss*

*dd* = day  
*mm* = month  
*yyyy* = year  
*hh* = hours  
*mm* = minutes  
*ss* = seconds

This command sets the next filter tape change. The following example sets the filter time to October 1, 2008, 11:32 pm.

```
Send:      set filter time 10-01-2008 23:32
Receive:   set filter time 10-01-2008 23:32 ok
```

---

### flow target

This command reports the current flow. The following example reports that the flow is 16.0 LPM.

```
Send:      flow target
Receive:   flow target 16.00
```

### set flow target *value*

This command sets the flow to *value*, where *value* is a floating-point number representation of flow between 1 to 20 LPM. The following example sets the flow to 16.67 LPM.

```
Send:      set flow target 16.67
Receive:   set flow target 16.67 ok
```

---

### ht control

This command reports the current status of the heater (off, RH threshold, or temp threshold). The following example reports that the heater is RH threshold.

```
Send:      ht control
Receive:   ht control RH
```

### set ht control *selection*

*selection* = | off | rh | temp |

This command sets the heater to off, RH threshold, or temp threshold. The following example sets the heater to temp threshold.

```
Send:          set ht control temp
Receive:       set ht control temp ok
```

---

#### **mass limit**

This command reports the current filter mass limit. The following example reports that the mass limit is 1,500 mg.

```
Send:          mass limit
Receive:       mass limit 1500
```

#### **set mass limit *value***

This command sets the filter mass limit to *value*, where *value* is a floating-point number representation of mass limit between 0.5 to 5.0 mg or 500 to 5,000 µg. The following example sets the mass limit to 1.0 mg.

```
Send:          set mass limit 1.0
Receive:       set mass limit 1.0 ok
```

---

#### **pres comp**

This command reports whether pressure compensation is for actual or standard conditions. The following example shows the pressure compensation is standard.

```
Send:          pres comp
Receive:       pres comp std
```

#### **set pres comp *selection***

*selection* = | act | std |

These commands turn the pressure compensation to either actual or standard conditions. The following example turns the pressure compensation to actual.

```
Send:          set pres comp act
Receive:       set pres comp act ok
```

---

#### **pres std**

This command reports the standard pressure. The following example reports that the standard pressure is 760 mmHg.

```
Send:          pres std
Receive:       pres std 760 mmHg
```

**set pres std *value***

This command sets the standard pressure to *value*, where *value* is a floating-point number representation of standard pressure between 0 to 760 mmHg. The following example sets the standard pressure to 730 mmHg.

```
Send:      set pres std 730
Receive:   set pres std 730 ok
```

**range**

This command reports the current PM range. If the mode is incorrect, the instrument responds with “can’t, wrong settings”. The following example reports that the PM range is set to 5 mg/m<sup>3</sup>, according to [Table B-5](#).

```
Send:      range
Receive:   range 4: (5.000E+00 mg/m3)
```

**set range *selection***

This command selects the PM ranges, according to [Table B-5](#). The following example sets the PM range to 10 mg/m<sup>3</sup>.

```
Send:      set range 5
Receive:   set range 5 ok
```

**Table B-5.** Standard Ranges

<i>Selection</i>	$\mu\text{g}/\text{m}^3$	$\text{mg}/\text{m}^3$
0	100	0.1
1	1000	1.0
2	2000	2.0
3	3000	3.0
4	5000	5.0
5	10000	10.0
6	C1	C1
7	C2	C2
8	C3	C3

**rh th**

This command reports the current heater RH threshold for the sample. The following example reports that the RH threshold is 30%.

```
Send:      rh th
Receive:   rh th 30%
```

**set rh th *value***

This command sets the heater RH threshold for the sample to *value*, where *value* is a floating-point number representation of RH threshold between 25 to 90%. The following example sets the RH threshold to 35%.

Send:            set rh th 35  
Receive:        set rh th 35 ok

---

**temp comp**

This command reports whether temperature compensation is for actual or standard conditions. The following example shows the temperature compensation is standard.

Send:            temp comp  
Receive:        temp comp std

**set temp comp *selection***

*selection* = | act | std |

These commands turn the temperature compensation to either actual or standard conditions. The following example turns the temperature compensation to actual.

Send:            set temp comp act  
Receive:        set temp comp act ok

---

**temp std**

This command reports the standard temperature. The following example reports that the standard temperature is 18 °C.

Send:            temp std  
Receive:        temp std 18 degC

**set temp std *value***

This command sets the standard temperature to *value*, where *value* is a floating-point number representation of standard temperature between 0 to 25 °C. The following example sets the standard temperature to 15 °C.

Send:            set temp std  
Receive:        set temp std 15 ok

---

**temp th**

This command reports the heater temperature threshold for the sample. The following example reports that the temperature threshold is 30 °C.

Send:            temp th  
Receive:        temp th 30 degC



## Hardware Configuration

### set temp th *value*

This command sets the heater temperature threshold for the sample to *value*, where *value* is a floating-point number representation of temperature threshold between 0 to 70 °C. The following example sets the temperature threshold to 35 °C.

```
Send:      set temp th 35
Receive:   set temp th 35 ok
```

---

### contrast

This command reports the screen's level of contrast. The following example shows the screen contrast is 55%, according to [Table B-6](#).

```
Send:      contrast
Receive:   contrast 11: 55%
```

### set contrast *level*

This command sets the screen's *level* of contrast, according to [Table B-6](#). The following example sets the contrast level to 50%.

```
Send:      set contrast 10
Receive:   set contrast 10 ok
```

**Table B-6.** Contrast Levels

<i>Level</i>	<b>Contrast Level</b>
0	0%
1	5%
2	10%
3	15%
4	20%
5	25%
6	30%
7	35%
8	40%
9	45%
10	50%
11	55%
12	60%
13	65%
14	70%
15	75%

<i>Level</i>	<b>Contrast Level</b>
16	80%
17	85%
18	90%
19	95%
20	100%

---

### **date**

This command reports the current date. The following example reports the date as April 1, 2009.

```
Send:      date
Receive:   date 04-01-09
```

### **set date *mm-dd-yy***

*mm* = month

*dd* = day

*yy* = year

This command sets the date of the analyzer's internal clock. The following example sets the date to May 1, 2009.

```
Send:      set date 05-01-09
Receive:   set date 05-01-09 ok
```

---

### **set default params**

This command sets all the parameters to their default values. This does not affect the factory-calibrated parameters.

```
Send:      set default params
Receive:   set default params ok
```

---

### **det**

This command reports the status of the detector board (sharp/beta/map/none). The following example reports that the detector is beta.

```
Send:      det
Receive:   det beta
```

---

### **pump**

This command reports the current status of pump as on or off. The following example reports that the pump is set to off.

Send: pump  
Receive: pump off

**set pump *onoff***  
*onoff* = | on | off |

This command sets the pump *on* or *off*. The following example sets the pump to on.

Send: set pump on  
Receive: set pump on ok

### **save**

#### **set save params**

These commands store all current parameters in FLASH memory. It is important that each time instrument parameters are changed, that this command be sent. If changes are not saved, they will be lost in the event of a power failure. The following example saves the parameters to FLASH memory.

Send: set save params  
Receive: set save params ok

### **time**

This command reports the current time (24-hour format). The following example reports that the internal time is 2:15:30 pm.

Send: time  
Receive: time 14:15:30

#### **set time *hh:mm:ss***

*hh* = hours

*mm* = minutes

*ss* = seconds

This command sets the internal clock (24-hour format). The following example sets the internal time to 2:15 pm.

**Note** If seconds are omitted, the seconds default to 00. ▲

Send: set time 14:15  
Receive: set time 14:15 ok

## **Communications Configuration**

### **addr dns**

This command reports the TCP/IP address for the domain name server.

Send: addr dns  
Receive: addr dns 192.168.1.1

**set addr dns *address***

This command sets the domain name server *address*, where *address* consists of four numbers ranging from 0-255 inclusive, separated by “.”.

```
Send:          set addr dns 192.168.1.1
Receive:       set addr dns 192.168.1.1 ok
```

---

**addr gw**

This command reports the default TCP/IP gateway address.

```
Send:          addr gw
Receive:       addr gw 192.168.1.1
```

**set addr gw *address***

This command sets the default gateway *address*, where *address* consists of four numbers ranging from 0-255 inclusive, separated by “.”.

**Note** This command cannot be used when DHCP is on. Refer to the DHCP command that follows for additional information. ▲

```
Send:          set addr gw 192.168.1.1
Receive:       set addr gw 192.168.1.1 ok
```

---

**addr ip**

This command reports the IP address of the analyzer.

```
Send:          addr ip
Receive:       addr ip 192.168.1.200
```

**set addr ip *address***

This command sets the analyzer’s IP *address*, where *address* consists of four numbers ranging from 0-255 inclusive, separated by “.”.

**Note** This command cannot be used when DHCP is on. Refer to the DHCP command that follows for additional information. ▲

```
Send:          set addr ip 192.168.1.200
Receive:       set addr ip 192.168.1.200 ok
```

---

**addr nm**

This command reports the IP netmask.

```
Send:          addr nm
Receive:       addr nm 255.255.252.0
```

**set addr nm** *mask*

This command sets the netmask *mask*, where *mask* consists of four numbers ranging from 0-255 inclusive, separated by “.”.

**Note** This command cannot be used when DHCP is on. Refer to the DHCP command that follows for additional information. ▲

```
Send:          set addr nm 255.255.252.0
Receive:       set addr nm 255.255.252.0 ok
```

**addr ntp**

This command reports the IP address for the network time protocol server. See “Network Time Protocol Server” in the Communications Settings” section of the “Operation” chapter for more information.

```
Send:          addr ntp
Receive:       addr ntp 10.209.43.237
```

**set addr ntp** *address*

This command sets the network time protocol server *address*, where *address* consists of four numbers ranging from 0-255 inclusive, separated by “.”.

```
Send:          set addr ntp 10.209.43.237
Receive:       set addr ntp 10.209.43.237 ok
```

**allow mode cmd**

This command reports the current allow mode setting: 1 = allow “set mode local” and “set mode remote” commands; 0 = ignore “set mode local” or “set mode remote” commands, according to [Table B-7](#). The default value is 0; ignore the commands. The following example shows that the instrument is configured to ignore “set mode local” or “set mode remote” commands.

```
Send:          allow mode cmd
Receive:       allow mode cmd 0
```

**set allow mode cmd** *value*

This command is used to configure the instrument to *value*, where *value* is either 1 = accept or 0 = ignore the “set mode local” and “set mode remote” commands, according to [Table B-7](#).

If the instrument is set to accept the commands (*value* = 1), the “set mode local” command will unlock the instrument and the keypad can be used to make changes via the front panel.

If the instrument is set to ignore the commands (*value* = 0), the instrument will respond with “ok” as if the command has been accepted and acted upon, **but will not change the instrument lock status** (this is for compatibility with systems expecting and “ok” response).

**Note** The instrument will always respond to the command “mode” with the status of the password lock as “mode local” or “mode remote”, regardless of the above setting. ▲

The following example sets the instrument to accept the “set mode local” and “set mode remote” commands.

```
Send:          set allow mode cmd 1
Receive:       set allow mode cmd 1 ok
```

**Table B–7.** Allow Mode Command Values

<i>Value</i>	<b>Allow Mode Command</b>
0	Ignore (default)
1	Accept

---

### **baud**

This command reports the current baud rate for the serial port (RS232/RS485). The following example reports that the current baud rate is 9600 baud.

```
Send:          baud
Receive:       baud 9600
```

### **set baud *rate***

*rate* = | 1200 | 2400 | 4800 | 9600 | 19200 | 38400 | 57600 | 115200 |

This command sets the instrument baud rate to *rate*. The following example sets the instrument’s baud rate to 9600.

**Note** After the command is sent, the baud rate of the sending device must be changed to agree with the instrument. ▲

```
Send:          set baud 9600
Receive:       set baud 9600 ok
```

---

### dhcp

This command reports the current state of use of the Dynamic Host Configuration Protocol (DHCP) as on or off. DHCP is used to assign an IP address to the instrument automatically. The following example shows that DHCP is on.

```
Send:      dhcp
Receive:   dhcp on
```

### set dhcp *onoff*

*onoff* = | on | off |

This command enables (*on*) and disables (*off*) the DHCP service. When DHCP is set to on, the instrument gets the IP address, the netmask address, and the gateway address from a DHCP server. When DHCP is set to off, the instrument gets these addresses from system memory. The following example sets the DHCP service to on.

**Note** If DHCP is changed from on to off and then the IP address, the netmask address, or the gateway address is changed, you must cycle power to the instrument before the change takes effect. Until you cycle the power, the address assigned by the DHCP server will still be used and reported as the current address. ▲

```
Send:      set dhcp on
Receive:   set dhcp on ok
```

---

### format

This command reports the current reply termination format. The following example shows that the reply format is 00, which means reply with no checksum, according to [Table B-8](#).

```
Send:      format
Receive:   format 00
```

### set format *format*

This command sets the reply termination *format*, where *format* is set according to [Table B-8](#). The following example sets the reply termination format to checksum.

```
Send:      set format 01
Receive:   set format 01 ok
```

**Table B–8.** Reply Termination Formats

<i>Format</i>	<b>Reply Termination</b>
00	<CR>
01	<NL> sum xxxx <CR>

where xxxx = 4 hexadecimal digits that represent the sum of all the characters (bytes) in the message

---

#### **host name**

This command reports the host name string. The following example reports the host name is set to *iSeries*.

```
Send:          host name
Receive:       host name iSeries
```

#### **set host name *string***

This command sets the host name *string*, where *string* is 1-13 alphanumeric characters. The following example sets the host name to *analyzer01*.

```
Send:          set host name analyzer01
Receive:       set host name analyzer01 ok
```

---

#### **instr name**

This command reports the instrument name. The following example reports the instrument name for the Model 5014*i*.

```
Send:          instr name
Receive:       instr name
               Beta
               Particle Analyzer
```

---

#### **instrument id**

This command reports the instrument identification (ID). The following example reports the current setting of the instrument ID.

```
Send:          instrument id
Receive:       instrument id 14
```

#### **set instrument id *value***

This command sets the instrument ID to *value*, where *value* is an integer between 0 and 127 inclusive. The following example shows the instrument ID changed to 12.

**Note** Sending this command via RS-232 or RS-485 will require the host to use the new ID for subsequent commands. ▲



```
Send:      set instrument id 12
Receive:   set instrument id 12 ok
```

### layout ack

This command reports the stale layout/layout change indicator (\*) that is attached to each response if the erc layout has changed since the last time erc layout was requested, according to [Table B-9](#). The following example reports that the instrument is configured to do nothing.

```
Send:      layout ack
Receive:   layout ack 0
```

### set layout ack *value*

This command disables the stale layout/layout change indicator (\*) that is attached to each response if the erc layout has changed since the last time erc layout was requested, according to [Table B-9](#).

```
Send:      set layout ack
Receive:   set layout ack ok
```

**Table B-9.** Set Layout Ack Values

<i>Value</i>	<b>Function</b>
0	Do nothing (default)
1	Append "*"

### power up mode

This command reports the current power up mode setting to either 0 = local/unlocked or 1 = remote/locked, according to [Table B-10](#). The default value is 0; power up in local/unlocked mode. The following example shows that the instrument is configured to power up in the remote/locked mode.

```
Send:      power up mode
Receive:   power up mode 1
```

### set power up mode *value*

This command is used to configure the instrument to power up in the local/unlocked mode (*value* = 0) or the remote/locked mode (*value* = 1), according to [Table B-10](#).

If the instrument is set to power up in the local/remote mode, the keypad can be used to make changes via the front panel. If the instrument is set to power up in the remote/locked mode, changes can not be made from the

front panel. The following example sets the instrument to power up in remote/locked mode.

```
Send:          set power up mode 1
Receive:       set power up mode 1 ok
```

**Table B–10.** Power Up Mode Values

<i>Value</i>	<b>Power up Mode</b>
0	Local/Unlocked Mode (default)
1	Remote/Locked Mode

---

### **program no**

This command reports the analyzer’s model information and program version number.

```
Send:          program no
Receive:       program no iSeries 5014i 00.05.37.093
```

---

### **tz**

This command reports the “tz” timezone string for the NTP server. See “Network Time Protocol Server” in the “Communications Settings” section of the “Operation” chapter for more information.

```
Send:          tz
Receive:       tz EST+5EDT
```

### **set tz string**

This command sets the timezone *string* for the instrument for use with the NTP server, where *string* is a standard timezone string. Common strings are listed in the “Timezone” screen description in Chapter 3.

```
Send:          set tz EST+5EDT
Receive:       set tz EST+5EDT ok
```

## **I/O Configuration**

---

### **analog iout range channel**

This command reports the analog current output range setting for *channel*, where *channel* must be between 1 and 6, inclusive. The following example reports current output channel 4 is in the 4-20 mA range, according to [Table B–11](#). This command responds with “feature not enabled” if the I/O expansion board is not detected.

```
Send:          analog iout range 4
Receive:       analog iout range 4 2
```

**set analog iout range *channel range***

This command sets analog current output *channel* to the *range* where *channel* is between 1 and 6 inclusive, and *range* is set according to [Table B-11](#). The following example sets current output channel 4 to the 0-20 mA range. This command responds with “feature not enabled” if the I/O expansion board is not detected.

```
Send:          set analog iout range 4 1
Receive:       set analog iout range 4 1 ok
```

**Table B-11.** Analog Current Output Range Values

<i>Range</i>	<b>Output Range</b>
1	0-20 mA
2	4-20 mA
0 [cannot be set to this, but may report]	Undefined

---

**analog vin *channel***

This command retrieves the analog voltage input *channel* data, both the calculated value and the actual voltage. In the following example, the “calculated” value of channel 1 is 75.325 degrees F, volts are 2.796. This command responds with “feature not enabled” if the I/O expansion board is not detected.

```
Send:          analog vin 1
Receive:       analog vin 1 75.325, 2.796 V
```

---

**analog vout range *channel***

This command reports the analog voltage output *channel* range, where *channel* is between 1 and 6 inclusive, according to [Table B-12](#). The following example reports that analog voltage output channel 2 is set to 3 (0-10 V).

```
Send:          analog vout range 2
Receive:       analog vout range 2 3
```

**set analog vout range *channel range***

This command sets analog voltage output *channel* to the range, where *channel* is between 1 and 6 inclusive, and *range* is set according to [Table B-12](#). The following example sets channel 2 to the 0-10 V range.

```
Send:          set analog vout range 2 3
Receive:       set analog vout range 2 3 ok
```

**Table B–12.** Analog Voltage Output Range Values

<i>Range</i>	<b>Output Range</b>
1	0-1 V
2	0-100 mV
3	0-10 V
4	0-5 V
0 [cannot be set to this, but may report]	Undefined

---

### **dig in**

This command reports the status of the digital inputs as a 4-digit hexadecimal string with the most significant bit (MSB) being input 16.

Send:            dig in  
Receive:        dig in 0xffff

---

### **din channel**

This command reports the action assigned to the digital input *channel* and the index number of the corresponding active state. The following example reports input 1 to be assigned an index number 3 corresponding to action of “PM mode” with the active state being high.

Send:            din 1  
Receive:        din 1 3 PM MODE high

### **set din channel index state**

This command assigns digital input *channel* (1-16) to activate the action indicated by *index* (1-12), when the input transitions to the designated *state* (high or low). Use the “list var din” command to obtain the list of supported *index* values and corresponding actions. The following example sets the digital input channel 1 to 3 on a low-to-high transition.

Send:            set din 1 3 high  
Receive:        set din 1 3 high ok

---

### **dout channel**

This command reports the index number, output variable and the active state assigned to digital output *channel*. The following example reports output 4 to be assigned an index number 11 corresponding to action of “flow alarms”.

Send:            dout 4  
Receive:        dout 4 11 FLOW ALARMS open

**set dout *channel index state***

This command assigns digital output *channel* to be assigned to the action associated with *index*, and assigns it an active state of *state* (open or closed). Use the “list var dout” command to obtain the list of supported index values and corresponding state. The following example sets the digital output channel 4 to state 11.

```
Send:          set dout 4 11 open
Receive:       set dout 4 11 open ok
```

**dtoa *channel***

This command reports the outputs of the 6 or 12 Digital to Analog converters, according to [Table B-13](#). The following example shows that the D/A #1 is 97.7% full-scale.

```
Send:          dtoa 1
Receive:       dtoa 1 97.7%
```

**Note** If the instrument is in a mode which does not provide a particular output, and that output is selected, the value will be 0.0. ▲

All channel ranges are user definable. If any customization has been made to the analog output configuration, the default selections may not apply. ▲

**Table B-13.** Default Analog Output Channel Assignments

D to A	Function	Range
1	Voltage Output	PM
2	Voltage Output	AVG PM
3	Voltage Output	Flow
4	Voltage Output	Ambient Temperature
5	Voltage Output	Flow Temperature
6	Voltage Output	Ambient Relative Humidity
7	Current Output	PM
8	Current Output	AVG PM
9	Current Output	Flow
10	Current Output	Ambient Temperature
11	Current Output	Flow Temperature
12	Current Output	Ambient Relative Humidity

---

**list din**

**list dout**

These commands report the current selection for the digital inputs or the digital outputs in the format. Output no Index number variable name active state. The active state for digital outputs is open or closed. The active state for digital inputs is high or low.

```
Send:      list dout
Receive:   list dout
           output index variable state
           1 5 CONC ALARM open
           2 1 LOCAL/REMOTE open
           3 3 UNITS open
```

---

**list var aout**

**list var dout**

**list var din**

**list var log**

These commands report the list of possible index numbers, and the variables (associated with that index number) available for selection in the current mode for analog outputs, digital outputs, digital inputs and datalogging. The index number is used to insert the variable in a field location in a list using “set sp *field index*”. The following example reports the list of analog outputs, index numbers, and variables.

```
Send:      list var aout
Receive:   list var aout
           index variable
           0 none
           1 pm
           3 baro
           4 vac
           6 pflow
           8 ambrt
           9 srh
           11 ambtemp
           12 brdtemp
           13 ftemp
           15 stemp
           17 frol
           19 beta
           28 braw
           29 araw
           30 avgpm
           32 mass
           34 bzero
           45 exfg
           50 bref
           52 cflg
           53 aflg
```

---

### relay stat

This command reports the current relay logic as normally “open” or normally “closed,” if all the relays are set to same state, that is all open or all closed. The following example shows that the status of all the relays’ logic is set to normally “open”.

```
Send:      relay stat
Receive:   relay stat open
```

**Note** If individual relays have been assigned different logic, then the response would be a 4-digit hexadecimal string with the least significant byte (LSB) being relay no 1. ▲

For example:

```
Receive:   relay stat 0x0001
(indicates relay no 1 is set to normally open logic, all others are normally
closed)
```

```
Receive:   relay stat 0x0005
(indicates relay no 1 and 3 are set to be normally open logic, all others are
normally closed)
```

### set relay open

**set relay open** *value*

**set relay closed**

**set relay closed** *value*

These commands set the relay logic to normally open or closed for relay number *value*, where *value* is the relay between 1 and 16. The following example sets the relay no 1 logic to normally open.

**Note** If the command is sent without an appended relay number, then all the relays are assigned the set logic of normally open/closed. ▲

```
Send:      set relay open 1
Receive:   set relay open 1 ok
```

## Record Layout Definition

The erc, lrec, and srec layouts contain the following:

- A format specifier for parsing ASCII responses
- A format specifier for parsing binary responses

In addition to these, the erc layout contains:

- A format specifier for producing the front panel display screens

Values are read using either the ASCII or binary format specifiers and converted to uniform internal representations (32-bit floats or 32-bit integers). These values are converted into text for display on the screen using the format specifier for the front panel display. Normally, the specifier used to parse a particular datum from the input stream will be strongly related to the specifier used to display it (such as, all of the floating point inputs will be displayed with an 'f' output specifier, and all of the integer inputs will be displayed with a 'd' specifier).

## Format Specifier for ASCII Responses

The first line of the layout response is the scanf-like parameter list for parsing the fields from an ASCII erc response. Parameters are separated by spaces and the line is terminated by a “\n” (the normal line separator character). Valid fields are:

- %s - parse a string
- %d - parse a decimal number
- %ld - parse a long (32-bit) decimal number
- %f - parse a floating point number
- %x - parse a hexadecimal number
- %lx - parse a long (32-bit) hex number
- %\* - ignore the field

**Note** Signed versus unsigned for the integer values does not matter; it is handled automatically. ▲

## Format Specifier for Binary Responses

The second line of the layout response is the binary parameter list for parsing the fields from a binary response. Parameters MUST be separated by spaces, and the line is terminated by a '\n'. Valid fields are:

- t - parse a time specifier (2 bytes)
- D - parse a date specifier (3 bytes)
- i - ignore one 8-bit character (1 byte)
- e - parse a 24-bit floating point number (3 bytes: n/x)
- E - parse a 24-bit floating point number (3 bytes: N/x)
- f - parse a 32-bit floating point number (4 bytes)
  
- c - parse an 8-bit signed number (1 byte)
- C - parse an 8-bit unsigned number (1 byte)
- n - parse a 16-bit signed number (2 bytes)
- N - parse a 16-bit unsigned number (2 bytes)
- m - parse a 24-bit signed number (3 bytes)
- M - parse a 24-bit unsigned number (3 bytes)
- l - parse a 32-bit signed number (4 bytes)
- L - parse a 32-bit unsigned number (4 bytes)



There is an optional single digit  $d$  which may follow any of the numeric fields, which indicates that after the field has been parsed out, the resulting value is to be divided by  $10^d$ . Thus the 16-bit field 0xFFC6 would be interpreted with the format specifier 'n3' as the number -0.058.

## Format Specifier for Erec Layout

The subsequent lines in the errec layout response describe the appearance of the full panel. The full instrument panel as it appears on the screen has two columns of lines. Each line is composed of three major components: (1) a text field, (2) a value field, and (3) a button. None of these three components is required. The text field contains statically displayed text.

The value field displays values which are parsed out of the response to a errec command. It also displays, though background changes, alarm status. The button, when pressed, triggers input from either a dialog box or a selection list. There are five kinds of buttons, B, I, L, T, and N.

Each line in the layout string corresponds to one line on the display. The layout string describes each of the three major fields as well as translation mechanisms and corresponding commands.

**Text** The first field in the layout string is the text. It is delimited by a ':'. The string up to the first ':' will be read and inserted in the text field of the line.

**Value String** This is followed by a possible string enclosed in quotes that is used to place a string into the value field.

**Value Source** The value source, which is the item (or word) number in the DATA/EREC response, appears next. This is followed by an optional bitfield designator. The datum identified by the value source can be printed as a string 's', hexadecimal 'x', decimal 'd', floating point 'f', or binary 'b' number. Typically, bitfield extractions are only done for decimal or hexadecimal numbers.

Floating-point numbers can be followed with an optional precision specifier which will be used as an argument to printf's %f format (for example, a field of '4' would be translated into the printf command of '%.3f'). Alternately, the special character '\*' can precede the precision specifier; this causes an indirection on the precision specifier (which now becomes a field number).

This is useful when formatting, for example, numbers which have varying precision depending on the mode of the instrument.

Binary numbers can also have an optional precision specifier which is used to determine how many bits to print. For example, the specifier 'b4' will print the lowest four bits of the parsed number.

There are serious restrictions on where an 's' field may appear: currently sources 1 and 2 must be 's', and no others may be 's'.

**Alarm Information**

The value source is followed by optional alarm information, indicated by a commercial at sign '@' with a source indicator and a starting bit indicator. All alarm information is presumed to be two bits long (low and high). The bitfield extraction is performed on the integer part of the source. Typical alarm information would appear as '@6.4'.

**Translation Table**

Then, there appears an optional translation table within braces '{}'. This is a string of words separated by spaces. An example translation table would be '{Code\_0 Code\_1 Code\_2 Code\_3}'. The value, once extracted, is used as a zero-based index into the translation table to determine the string to display.

**Selection Table**

Then there appears an optional selection table within parentheses '(...)'. This is a string of numbers separated by spaces '(0 1)'. The selection table lists the translation table entries which the user may select from when setting the parameter. This is not necessarily the same as the entries which may be displayed.

**Button Designator**

Then there appears an optional button designator. This will be one of 'B', 'I', 'L', 'T', or 'N'.

B- Indicates a button which pops up an input dialog prompting the user for a new value using the designated input format. The input format is specified from the 'B' through the subsequent semicolon.

I—Indicates a button which pops up a selection list with input translation. That is, the values read are translated before they are compared to the selection list options.

L—Indicates a button which pops up a selection list without any translation. The output value is the number of the selected option.

T—Indicates a button which pops up a selection list with output translation. The number of the option selected is used as an index into the translation table to generate an output string.

N—Indicates a button which only sends the subsequent command to the instrument. No user-prompting happens.

The following string through an optional '|' or the end of the line is the command which is to be sent to the instrument upon the completion of the button selection. The command string should normally contain print-style formatting to include the user input. If a '|' is present, it indicates a command which is sent to the instrument upon successful completion of the button command to update the value field.

**Examples** Some examples ('\n' is the C syntax for an end-of-line character):

```
'Concentrations\n'
```

This is a single text-only line.

```
'\n'
```

This is a single blank line.

```
' NO:3s\n'
```

This is a line which appears slightly indented. The text field is 'NO', the value is taken from the third element of the data response, and interpreted as a string.

```
' NO:18sBd.ddd;set no coef %s\n'
```

This is a line which also appears slightly indented. The next field is also 'NO', but the value is taken from the eighteenth element of the data response, again interpreted as a string. A button appears on this line which, when pressed, pops up an input dialog which will state "Please enter a new value for NO using a d.ddd format." The string entered by the user is used to construct the output command. If the user enters, for example, '1.234', the constructed command will be 'set no coef 1.234'.

```
' NO:21f{Code_0 Code_1 Code_2 Code_3 Code_4 Code_5 Code_6  
Code_7 Code_8 Code_9 Code_10 Code_11}Lset range no %d\n'
```

This is a line which appears slightly indented, the title is again 'NO', and the value is the twenty-first element of the data response, interpreted as a floating-point number. There is a no-translation button which creates a selection list of twelve "Code nn" options. The number of the user selection is used to create the output command.

```
'Mode:6.12-13x{local remote service service}(0 1)Tset mode  
%s\n'
```

This is a line which has a title of 'Mode' and value taken from the sixth field of the data response. There is a bitfield extraction of bits 12 through 13 from the source (the value type is not important here because the value is being translated to an output string). Once the bits have been extracted, they are shifted down to the bit-zero position. Thus, the possible values of this example will be 0 through 3. The translation list shows the words which correspond to each input value, the zero index value appearing first (0 -> local, 1 -> remote, etc.). The selection list shows that only the first two values, in this case, are to be shown to the user when the button is pressed. The 'T' button indicates full translation, input code to string, and user selection number to output string.

```
'\xC'
```

This is a line that starts a new column (the \xC or ^L).

```
' Comp:6.11x{off on}Tset temp comp %s\n'
```

This shows that the bitfield end (the second part of a bitfield specification) is optional. The bitfield will be one bit long, starting in this case at the eleventh bit.

```
'Background:7f*8Bd.ddd;set o3 bkg %s\n'
```

This shows the use of indirect precision specifiers for floating point displays. The background value is taken from the 7th element, and the precision specifier is taken from the 8th. If the asterisk were not present, it would indicate instead that 8 digits after the decimal point should be displayed.

# Appendix C

## MODBUS Protocol

This appendix provides a description of the MODBUS Protocol Interface and is supported both over RS-232/485 (RTU protocol) as well as TCP/IP over Ethernet.

The MODBUS commands that are implemented are explained in detail in this document. The MODBUS protocol support for the *iSeries* enables the user to perform the functions of reading the various concentrations and other measurement values, read the status of the digital outputs of the analyzer, and to trigger or simulate the activation of a digital input to the instrument. This is achieved by using the supported MODBUS parameters listed below.

Up to three simultaneous connections are supported over Ethernet.

For details of the Model 5014*i* MODBUS Protocol specification, see the following topics:

- “Serial Communication Parameters” on page C-1
- “TCP Communication Parameters” on page C-2
- “Application Data Unit Definition” on page C-2
- “Function Codes” on page C-3
- “MODBUS Parameters Supported” on page C-8

Additional information on the MODBUS protocol can be obtained at <http://www.modbus.org>. References are from MODBUS Application Protocol Specification V1.1a MODBUS-IDA June 4, 2004.

### Serial Communication Parameters

The following are the communication parameters that are used to configure the serial port of the *iSeries* to support MODBUS RTU protocol.

Number of Data bits	: 7 or 8
Number of Stop bits	: 1 or 2
Parity	: None, Odd, or Even
Data rate	: 1200 to 115200 Baud (9600 is default)

## TCP Communication Parameters

*i*Series instruments support the MODBUS/TCP protocol. The register definition is the same as for the serial interface. Up to three simultaneous connections are supported over Ethernet.

TCP connection port for MODBUS : 502

## Application Data Unit Definition

Here are the MODBUS ADU (Application Data Unit) formats over serial and TCP/IP:

Serial:	Slave Address	Function Code	Data	Error Check
TCP/IP:	MBAP Header	Function Code	Data	

## Slave Address

The MODBUS slave address is a single byte in length. This is the same as the instrument ID used for C-Link commands and can be between 1 and 127 decimal (i.e. 0x01 hex to 0x7F hex). This address is only used for MODBUS RTU over serial connections.

**Note** Device ID '0', used for broadcast MODBUS commands, is not supported. Device IDs 128 through 247 (i.e. 0x80 hex to 0xF7 hex) are not supported because of limitations imposed by C-Link. ▲

## MBAP Header

In MODBUS over TCP/IP, a MODBUS Application Protocol Header (MBAP) is used to identify the message. This header consists of the following components:

Transaction Identifier	2 Bytes	0x0000 to 0xFFFF (Passed back in response)
Protocol Identifier	2 Bytes	0x00 (MODBUS protocol)
Length	2 Bytes	0x0000 to 0xFFFF (Number of following bytes)
Unit Identifier	1 Byte	0x00 to 0xFF (Passed back in response)

A slave address is not required in MODBUS over TCP/IP because the higher-level protocols include device addressing. The unit identifier is not used by the instrument.

## **Function Code**

The function code is a single byte in length. The following function codes are supported by the instrument:

Read Coils	:	0x01
Read Inputs	:	0x02
Read Holding Registers	:	0x03
Read Input Registers	:	0x04
Force (Write) Single Coil	:	0x05
Read Exception Status	:	0x06

If a function code is received that is not in this list, an invalid function exception is returned.

## **Data**

The data field varies depending on the function. For more description of these data fields, see “Function Codes” below.

## **Error Check**

In MODBUS over serial, an error check is included in the message. This is not necessary in MODBUS over TCP/IP because the higher-level protocols ensure error-free transmission. The error check is a two-byte (16 bit) CRC value.

## **Function Codes**

This section describes the various function codes that are supported by the Model 5014*i*.

### **(0x01/0x02) Read Coils/Read Inputs**

Read Coils/Inputs read the status of the digital outputs (relays) in the instrument. Issuing either of these function codes will generate the same response.

These requests specify the starting address, i.e. the address of the first output specified, and the number of outputs. The outputs are addressed starting at zero. Therefore, outputs numbered 1–16 are addressed as 0–15.

The outputs in the response message are packed as one per bit of the data field. Status is indicated as 1 = Active (on) and 0 = Inactive (off). The LSB of the first data byte contains the output addressed in the query. The other outputs follow toward the high end of this byte, and from low order to high order in subsequent bytes. If the returned output quantity is not a multiple of eight, the remaining bits in the final data byte will be padded with zeros (toward the high order end of the byte). The Byte Count field specifies the quantity of complete bytes of data.

**Note** The values reported may not reflect the state of the actual relays in the instrument, as the user may program these outputs for either active closed or open. ▲

**Request**

Function Code	1 Byte	0x01 or 0x02
Starting Address	2 Bytes	0x0000 to maximum allowed by instrument
Quantity of Outputs	2 Bytes	1 to maximum allowed by instrument
Unit Identifier	1 Byte	0x00 to 0xFF (Passed back in response)

**Response**

Function Code	1 Byte	0x01 or 0x02
Byte Count	1 Byte	N*
Output Status	N Byte	N = N or N+1

\*N = Quantity of Outputs / 8, if the remainder not equal to zero, then N=N+1

**Error Response**

Function Code	1 Byte	0x01 or 0x02
Exception Code	1 Byte	01=Illegal Function, 02=Illegal Address, 03=Illegal Data, 04=Slave Device Failure

Here is an example of a request and response to read outputs 2–15:



**Request**

<i>Field Name</i>	<i>(Hex)</i>
Function	0x01
Starting Address Hi	0x00
Starting Address Lo	0x02
Quantity of Outputs Hi	0x00
Quantity of Outputs Lo	0x0D

**Response**

<i>Field Name</i>	<i>(Hex)</i>
Function	0x01
Byte Count	0x03
Output Status 2–10	0xCD
Output Status 11–15	0x0A

The status of outputs 2–10 is shown as the byte value 0xCD, or binary 1100 1101. Output 10 is the MSB of this byte, and output 2 is the LSB. By convention, bits within a byte are shown with the MSB to the left and the LSB to the right. Thus, the outputs in the first byte are '10 through 2', from left to right. In the last data byte, the status of outputs 15-11 is shown as the byte value 0x0A, or binary 0000 1010. Output 15 is in the fifth bit position from the left, and output 11 is the LSB of this byte. The four remaining high order bits are zero filled.

**(0x03/0x04) Read Holding Registers/Read Input Registers**

Read Holding/Input Registers reads the measurement data from the instrument. Issuing either of these function codes will generate the same response. These functions read the contents of one or more contiguous registers.

These registers are 16 bits each and are organized as shown below. All of the values are reported as 32-bit IEEE standard 754 floating point format. This uses 2 sequential registers, least significant 16 bits first.

The request specifies the starting register address and the number of registers. Registers are addressed starting at zero. Therefore, registers numbered 1–16 are addressed as 0–15. The register data in the response message are packed as two bytes per register, with the binary contents right justified within each byte. For each register, the first byte contains the high order bits and the second contains the low order bits.

**Request**

Function Code	1 Byte	0x03 or 0x04
Starting Address	2 Bytes	0x0000 to maximum allowed by instrument
Quantity of Registers	2 Bytes	1 to maximum allowed by instrument

**Response**

Function Code	1 Byte	0x03 or 0x04
Byte Count	1 Byte	2 x N*
Register Value	N* x 2 Bytes	N = N or N+1

\*N = Quantity of Registers

**Error Response**

Function Code	1 Byte	Function code + 0x80
Exception Code	1 Byte	01=Illegal Function, 02=Illegal Address, 03=Illegal Data, 04=Slave Device Failure

Here is an example of a request and response to read registers 10–13:

**Request**

<i>Field Name</i>	<i>(Hex)</i>
Function	0x03
Starting Address Hi	0x00
Starting Address Lo	0x09
No. of Registers Hi	0x00
No. of Registers Lo	0x04

**Response**

<i>Field Name</i>	<i>(Hex)</i>
Function	0x03
Byte Count	0x06
Register Value Hi (10)	0x02
Register Value Lo (10)	0x2B
Register Value Hi (11)	0x00
Register Value Lo (11)	0x00

Register Value Hi (12)	0x00
Register Value Lo (12)	0x64
Register Value Hi (13)	0x00
Register Value Lo (13)	0x64

The contents of register 10 are shown as the two byte values of 0x02 0x2B. Then contents of registers 11–13 are 0x00 0x00, 0x00 0x64 and 0x00 0x64, respectively.

### **(0x05) Force (Write) Single Coil**

The Force (Write) Single Coil function simulates the activation of the digital inputs in the instrument, which triggers the respective action.

This function code is used to set a single action to either ON or OFF. The request specifies the address of the action to be forced. Actions are addressed starting at zero. Therefore, action number 1 is addressed as 0. The requested ON/OFF state is specified by a constant in the request data field. A value of 0xFF00 requests the action to be ON. A value of 0x0000 requests it to be OFF. All other values are illegal and will not affect the output. The normal response is an echo of the request, returned after the state has been written.

**Note** This function will not work if the instrument is in service mode. ▲

#### **Request**

Function Code	1 Byte	0x05
Starting Address	2 Bytes	0x0000 to maximum allowed by instrument
Output Value	2 Bytes	0x0000 or 0xFF00

#### **Response**

Function Code	1 Byte	0x05
Starting Address	2 Bytes	0x0000 to maximum allowed by instrument
Output Value	2 Bytes	0x0000 or 0xFF00

#### **Error Response**

Function Code	1 Byte	Function code + 0x80
Exception Code	1 Byte	01=Illegal Function, 02=Illegal Address, 03=Illegal Data, 04=Slave Device Failure

Here is an example of a request to write Coil 5 ON:

**Request**

<i>Field Name</i>	<i>(Hex)</i>
Function	05
Output Address Hi	00
Output Address Lo	05
Output Value Hi	FF
Output Value Lo	00

**Response**

<i>Field Name</i>	<i>(Hex)</i>
Function	05
Output Address Hi	00
Output Address Lo	05
Output Value Hi	FF
Output Value Lo	00

## MODBUS Parameters Supported

Table C-1 through Table C-3 lists the MODBUS addresses supported for the Model 5014*i*.

**IMPORTANT NOTE** The addresses in the following tables are Protocol Data Unit (PDU) addresses. Verify the coil number on your MODBUS master to ensure that it matches the coil number on the instrument. ▲

**Note** Coil status 1 indicates active state. ▲

**Table C-1.** Read Coils for 5014*i*

<b>Coil Number</b>	<b>Status</b>
0	INVALID
1	LOCAL/REMOTE
2	SERVICE
3	[NOT USED]
4	GEN ALARM
5	CONC ALARM

Coil Number	Status
6	INST ALARMS
7	DET ALARMS
8	[NOT USED]
9	RH/TEMP ALARMS
10	PRES/VAC ALARMS
11	FLOW ALARMS
12	[NOT USED]
13	[NOT USED]
14	[NOT USED]
15	EXT ALARM 1
16	EXT ALARM 2
17	EXT ALARM 3

**IMPORTANT NOTE** The addresses in the following tables are Protocol Data Unit (PDU) addresses. Verify the register number on your MODBUS master to ensure that it matches the register number on the instrument. ▲

**Note** For additional information on how to read registers and interpret the data, refer to the “(0x03/0x04) Read Holding Registers/Read Input Registers” section in this appendix. ▲

**Table C–2.** Read Registers for 5014i

Register Number	Variable
0	INVALID
1 & 2	PMa
3 & 4	[NOT USED]
5 & 6	BARO PRES
7 & 8	VACUUM
9 & 10	[NOT USED]
11 & 12	FLOW PRES
13 & 14	[NOT USED]
15 & 16	AMB RH
17 & 18	SAMP RH
19 & 20	[NOT USED]

**MODBUS Protocol**

## MODBUS Parameters Supported

<b>Register Number</b>	<b>Variable</b>
21 & 22	AMB TEMP
23 & 24	BRD TEMP
25 & 26	FLOW TEMP
27 & 28	[NOT USED]
29 & 30	[NOT USED]
31 & 32	[NOT USED]
33 & 34	FLOW VOL
35 & 36	[NOT USED]
37 & 38	BETA
39 & 40	ANALOG IN 1
41 & 42	ANALOG IN 2
43 & 44	ANALOG IN 3
45 & 46	ANALOG IN 4
47 & 48	ANALOG IN 5
49 & 50	ANALOG IN 6
51 & 52	ANALOG IN 7
53 & 54	ANALOG IN 8
55 & 56	BETA RAW
57 & 58	ALPHA RAW
59 & 60	AVG PM
61 & 62	[NOT USED]
63 & 64	MASS
65 & 66	[NOT USED]
67 & 68	BETA ZERO
69 & 70	[NOT USED]
71 & 72	NEPH
73 & 74	NOT USED
75 & 76	NOT USED
77 & 78	NOT USED
79 & 80	NOT USED
81 & 82	NOT USED
83 & 84	SHARP
85 & 86	NOT USED
87 & 88	AVG SHARP

Register Number	Variable
89 & 90	NOT USED
91 & 92	EXT ALARMS
93 & 94	NEPH TEMP
95 & 96	NEPH RH
97 & 98	NEPH IRED
99 & 100	NEPH REF
101 & 102	BETA REF
103 & 104	NOT USED
105 & 106	COMMON FLAGS
107 & 108	BETA DETECTOR FLAGS
109 & 110	NOT USED
111 & 112	COMP MASS
113 & 114	NOT USED
115 & 116	AVG NEPH

**IMPORTANT NOTE** The addresses in the following tables are Protocol Data Unit (PDU) addresses. Verify the coil number on your MODBUS master to ensure that it matches the coil number on the instrument. ▲

**Note** Writing 1 to the coil number shown in the following table will initiate the “action triggered” listed in the table. This state must be held for at least 1 second to ensure the instrument detects the change and triggers the appropriate action. ▲

**Note** The coils within each coil group in the following table are mutually exclusive and will not be triggered if there is conflict. Before you assert (1) one coil in a group, make sure the other coils in the group are de-asserted (0). ▲

**Table C–3.** Write Coils for 5014i

Coil Number	Action Triggered
100	INVALID
101	[NOT USED]
102	[NOT USED]
103	[NOT USED]
104	AOUTS TO ZERO

## MODBUS Protocol

### MODBUS Parameters Supported

Coil Number	Action Triggered
105	AOUTS TO FS
106	FT COUNT
107	FILTER TAPE CNTRL
108	PUMP CNTRL ON/OFF
109	TEMP COMP ON/OFF
110	PRES COMP ON/OFF
111	HEATER ON/OFF
112	HTR RH/TEMP CNTRL
113	[NOT USED]
114	[NOT USED]
115	EXT ALARM 1
116	EXT ALARM 2
117	EXT ALARM 3



# Appendix D

## Gesytec (Bayern-Hessen) Protocol

This appendix provides a description of the Gesytec (Bayern-Hessen or BH) Protocol Interface and is supported both over RS-232/485 as well as TCP/IP over Ethernet.

The Gesytec commands that are implemented are explained in detail in this document. The Gesytec protocol support for the *iSeries* enables the user to perform the functions of reading the various concentrations and to trigger the instrument to be in sample/zero/span mode if valid for that instrument. This is achieved by using the supported Gesytec commands listed below.

Up to three simultaneous connections are supported over Ethernet.

For details of the Model 5014*i* Gesytec Protocol specification, see the following topics:

[“Serial Communication Parameters”](#) on page D-1

[“TCP Communication Parameters”](#) on page D-2

[“Instrument Address”](#) on page D-2

[“Abbreviations Used”](#) on page D-2

[“Basic Command Structure”](#) on page D-2

[“Block Checksum”](#) on page D-3

[“Gesytec Commands”](#) on page D-3

### Serial Communication Parameters

The following are the communication parameters that are used to configure the serial port of the *iSeries* to support Gesytec protocol.

Number of Data bits	: 7 or 8
Number of Stop bits	: 1 or 2
Parity	: None, Odd, or Even
Data rate	: 1200 to 115200 Baud (9600 is default)

## TCP Communication Parameters

iSeries instruments support the Gesytec protocol over TCP/IP. The register definition is the same as for the serial interface. Up to three simultaneous connections are supported over Ethernet.

TCP connection port for Gesytec: 9882

## Instrument Address

The Gesytec instrument address has a value between 0 and 127 and is represented by a 3 digit ASCII number with leading zeros or leading spaces if required (e.g. instrument address of 1 is represented as 001 or <SP><SP>1). The default instrument address is 14.

The instrument address is the same as the Instrument ID used for C-Link and MODBUS commands. This can be set via the front panel.

The instrument address is represented by <address> in the examples throughout this document.

**Note** Device IDs 128 through 247 are not supported because of limitations imposed by the C-Link protocol. ▲

## Abbreviations Used

The following is a list of abbreviations used in this document:

<CR> is abbreviation for Carriage Return (ASCII code 0x0D)

<STX> is abbreviation for Start of Text (ASCII code 0x02)

<ETX> is abbreviation for End of Text (ASCII code 0x03)

<SP> is abbreviation for space (ASCII code 0x20)

## Basic Command Structure

The following is the basic structure of a Gesytec command:

<STX>Command text<ETX><BCC>

OR

<STX>Command text<CR>

Each command is framed by control characters, <STX> at the start and terminated with either <ETX> or <CR>.

If a command is terminated with <ETX>, then two additional characters <BCC> is attached after <ETX>. This is the block checksum.

Block Checksum Characters <BCC> may be added to the command to prevent processing invalid commands.

## Block Checksum Characters <BCC>

The Block Checksum Characters are calculated beginning with a seed value of 00000000, binary (0x00), and bitwise exclusive ORing with each of the characters of the command string (or response) including the framing characters <STX> and <ETX>. The checksum works as an error check. The command terminator determines the presence or absence of <BCC>.

If a command is terminated by <ETX> then the next two characters are the checksum, if the command is terminated with <CR> no checksum is attached.

The block checksum is represented by two characters, which represent a 2 digit hex number (1byte) (e.g. 1 byte 0xAB hex checksum will be represented by the two characters 'A' & 'B').

The checksum is referred to as <BCC> throughout this document.

## Gesytec Commands

The following commands are supported by the Gesytec protocol:

- Instrument Control Command (ST)
- Data Sampling/Data Query Command (DA)

### Instrument Control Command (ST)

There is one control command supported by the Gesytec protocol.

This <control command> is a single letter, which triggers an action in the instrument. These commands are active only when service mode is inactive and the zero/span option is present.

Command 'N' initiates a filter change.

The following are the different acceptable formats of the ST command:

<STX>ST<address><control command><ETX><BCC>

OR

<STX>ST<address><control command><CR>

OR

<STX>ST<address><SP><control command><CR>

OR

<STX>ST<address><SP><control command><ETX><BCC>

The <address> is optional, which means it can be left out completely. The <address>, if present, must match the Instrument Address. Additional space can be present after the <address>.

If the received command does not satisfy the above formats, or if the <address> does not match the Instrument Address, the command is ignored.

This is a sample command to switch the instrument to initiate a filter change, instrument address 14:

```
<STX>ST014<SP>N<CR>
```

## Data Sampling/Data Query Command (DA)

This command initiates a data transfer from the instrument. The instrument responds with measurement data, which depends on the range mode and is listed in “[Measurements reported in response to DA command](#)” below.

The command structure for a data query command is as follows:

```
<STX>DA<address><ETX><BCC>
```

The <address> is optional, which means it can be left out completely. The <address>, if present, must match the Instrument Address. Additional space can be present after the <address>.

If the <address> is left out, then no space is allowed in the query string.

A command with no address is also a valid command.

The following are the different acceptable formats of the DA command with Instrument Address 14:

```
<STX>DA<CR>
```

```
<STX>DA014<CR>
```

```
<STX>DA<SP><14<ETX><BCC>
```

```
<STX>DA<ETX><BCC>
```

The data query string is valid and will be answered with data transmission only if the command starts with <STX>, which is followed by the characters DA, and the <address> (if present) matches the Instrument Address, and the command is terminated with either <CR> with no checksum or <ETX>, followed by the correct checksum <BCC>.

### Sample Data Reply String in response to Data Query Command (DA):

In response to a valid data query command, the instrument responds in the following format:

```
<STX>MD09<SP><address><SP><measured
value1><SP><status><SP><SFKT><SP><address+1><SP><measured
value2><SP><status><SP><SFKT><ETX><BCC>
```

The response uses the same command terminators as used by the received command, i.e. if the received command was terminated with a <CR> then the response is terminated with <CR>, and if the command was terminated with a <ETX><BCC>, then the response is terminated with <ETX> and the computed checksum <BCC>.

The 09 after the MD indicates that nine measurements are present in the reply string, 10 for ten measurements and so on. This will also determine the length of the reply string.

<address> is the Instrument Address. Each subsequent measurement attached to the response will have the <address + X>, where X keeps incrementing by 1 for each measurement included.

<measured value> is the concentration value in currently selected gas units, represented as exponential representation with 4 characters mantissa and 2 characters exponent, each with sign.

Mantissa: sign and 4 digits. The decimal point is assumed to be after the first digit and is not transmitted.

Exponent: sign and 2 digits.

#### Example:

-5384000.0 is represented as -5384+06

+0.04567 is represented as +4567-02

<status>: is formed by < operating status > and < error status > and separated by a space, i.e.:

```
<operating status><SP><error status>
```

Each of the two (<operating status> and <error status>) are formed by two characters, each representing a 2 digit hex number which is one byte (8 Bits) operation status and one byte (8 Bits) error status.

These two bytes contain the information about the main operating conditions of the instrument at that instant. For details on how to interpret the status bytes, refer to [Table D-1](#) and [Table D-2](#) below.

<SFKT>: is the space provided for future use for special function. It currently contains a string of ten 0's, i.e. <0000000000>.

The Gesytec serial number defaults to zero. To set the Gesytec serial number select Main Menu > Instrument Controls > Communication Settings > **Gesytec Serial No.**

**Example of response to DA command from an instrument with Gesytec serial number set to 000.** The Gesytec serial number is **bold** in the example.

Gesytec Protocol with transmission of three concentrations (Instrument ID is 1, Operation Status is 03, Error Status is 04):

Data Query String: <STX>DA<CR>

Reply String:

```

<STX>MD03<SP>001<SP>+2578+01<SP>03 <SP>04<SP>0000000000 <SP>002 <SP>
      ↑           ↑                               ↑
      Address  First Concentration(E-format)=25.78      Address+1

+5681+00<SP>03<SP>04<SP>0000000000<SP>003<SP>+1175+01<SP>03<SP>04<SP>
      ↑                               ↑           ↑
      Second Concentration = 5.681      Address+2  Third Concentration=11.75

0000000000<SP><CR>
  
```

**Example of response to DA command from an instrument with Gesytec serial number set to 123.** The Gesytec serial number is **bold** in the example.

Gesytec Protocol with transmission of three concentrations (Instrument ID is 1, Operation Status is 03, Error Status is 04):

Data Query String: <STX>DA<CR>

Reply String:

```

<STX>MD03<SP>001<SP>+2578+01<SP>03 <SP>04<SP>1230000000 <SP>002 <SP>
      ↑           ↑                               ↑
      Address  First Concentration(E-format)=25.78      Address+1

+5681+00<SP>03<SP>04<SP>0000000000<SP>003<SP>+1175+01<SP>03<SP>04<SP>
      ↑                               ↑           ↑
      Second Concentration = 5.681      Address+2  Third Concentration=11.75

1230000000<SP><CR>
  
```

The attached concentrations are in the selected gas units. The measurements that are attached to the response, if not valid in a particular mode, will report a value of 0.0.

## Measurements reported in response to DA command

The following 9 measurements reported in response to DA command for the Model 5014*i* include:

- PM
- Mass
- Volumetric Flow
- Ambient Temperature
- Flow Temperature
- Ambient RH
- Flow Pressure
- Vacuum Pressure
- Barometric Pressure

## Operating and Error Status

See [Table D-1](#) for operating status and [Table D-2](#) for error status for the Model 5014*i*.

**Table D-1.** Operating Status for Model 5014*i*

	D7	D6	D5	D4	D3	D2	D1	D0
→ Bit	8	7	6	5	4	3	2	1
→ Hex-value	80	40	20	10	08	04	02	01
	MSB				LSB			
<b>Operating status:</b>								
Service Mode (On)	0	0	0	0	0	0	0	1
Maintenance (Local)	0	0	0	0	0	0	1	0
Pump (Off)	0	0	0	0	0	1	0	0
Heater (Off)	0	0	0	0	1	0	0	0
Filter Change	0	0	0	1	0	0	0	0
Not Used	0	0	1	0	0	0	0	0
Not Used	0	1	0	0	0	0	0	0
Not Used	1	0	0	0	0	0	0	0

**Table D–2.** Error Status for Model 5014*i*

	D7	D6	D5	D4		D3	D2	D1	D0
→ Bit	8	7	6	5		4	3	2	1
→ Hex-value	80	40	20	10		08	04	02	01
	MSB					LSB			
<b>Error status:</b>									
Filter Counter	0	0	0	0		0	0	0	1
Filter Change	0	0	0	0		0	0	1	0
Beta Detector Alarm	0	0	0	0		0	1	0	0
Not Used	0	0	0	0		1	0	0	0
Detector Board Status Alarm	0	0	0	1		0	0	0	0
Motherboard Status Alarm	0	0	1	0		0	0	0	0
Flow Alarm	0	1	0	0		0	0	0	0
Not Used	1	0	0	0		0	0	0	0



# Appendix E

## ESM Protocol Commands

This appendix provides a description of the ESM Protocol commands (from the prior FH62 platform) that can be used to remotely control a Model 5014*i* instrument using a host device such as a PC or a datalogger. ESM protocol may be used over RS-232, RS-485 or over Ethernet. ESM functions can be accessed over Ethernet using TCP port 9884.

Up to three simultaneous connections per protocol may be made over Ethernet.

### ESM Commands Supported

Table E-1 through E-3 lists the ESM commands supported for the Model 5014*i*.

**Table E-1.** Read Commands for 5014*i*

Command	Description
C	output of the dust mass concentration in $\mu\text{g}/\text{m}^3$ (actual mode)
HT	24 h (daily) average concentration [ $\mu\text{g}/\text{m}^3$ ]
JB	temperature sampling head
JC	temperature dust sampling chamber
JD	temperature inside of the flow meter orifice
JF	different pressure of the air flow measuring module in Pa
JG	low pressure suction chamber
JH	barometer in hPa
JI	air flow sampling head
JJ	norm air flow (273K, 1013hPa)
JO	air flow rate regulation 0...100%
JR	relative humidity value (%RH)
JS	sample relative humidity value (%RH)
m1	non filtered mass in $\mu\text{g}$
o	reports "offline" in service mode, "online" if NOT in service mode
UA	beta count rate (1/s)
UB	beta zero count rate (1/s)

<b>Command</b>	<b>Description</b>
UC	alpha count rate (1/s)
UD	alpha zero count rate (1/s)
UQ	radon-EEC activity concentration (Bq/m <sup>3</sup> )
V	instrument model and software version
Z	read date/time of day answer: yy-mm-dd hh:mm:ss
ZZ	read date/time answer: yymmddhhmmss
?	read device address
#	flags

**Table E–2.** Write Commands for 5014*i*

<b>Command</b>	<b>Description</b>
d4	baud rate
d7	device address
K4	concentration factor
KB	filter change dust load in µg
KD	filter change cycle in hours
KG	external heating
KH	set point air flow regulation in l/h
KU	establishes the RH target value
KT	establishes the temp target value
K\$	norm-Pressure
K%	norm-Temp
Y\$	write parameters to EEPROM

**Table E–3.** Control Commands for 5014*i*

<b>Command</b>	<b>Description</b>
A	pump off
E	pump on
F	filter change